

Terrain Analysis



JULY 1990

DISTRIBUTION RESTRICTION:

Approved for public release; distribution is unlimited.

Headquarters,
Department of the Army

Terrain Analysis

Preface

SCOPE

Terrain analysis, an integral part of the intelligence preparation of the battlefield (IPB), plays a key role in any military operation. During peacetime, terrain analysts build extensive data bases for each potential area of operations. They provide a base for all intelligence operations, tactical decisions, and tactical operations. They also support the planning and execution of most other battlefield functions. Because terrain features continually undergo change on the earth's surface, data bases must be continuously revised and updated.

PURPOSE

This field manual prescribes basic doctrine and is intended to serve as a primary source of the most current available information on terrain analysis procedures for all personnel who plan, supervise, and conduct terrain analysis. The manual discusses the impact of the terrain and the weather on operations.

USER INFORMATION

The proponent of this publication is the US Army Engineer School. Submit changes for improving the publication on DA Form 2028 (Recommended Changes to Publications and Blank Forms) to Commandant, Directorate of Training and Doctrine, US Army Engineer School, ATTN: ATSE-TDM-P, Ft. Leonard Wood, MO 65473-6500.

Approved for public release; distribution is unlimited.

Unless otherwise stated, whenever the masculine gender is used, both men and women are included.

*This publication supersedes FM 21-33, 15 May 1978, and FM 30-10, 27 March 1972.

CHANGE
NO. 1

HEADQUARTERS
DEPARTMENTS OF THE ARMY
Washington, DC, 8 September 1992

Terrain Analysis

1. Change FM 5-33, 11 July 1990, as follows:

Page 10-1. Table 10-1, 2. Circles, change formulas to read:

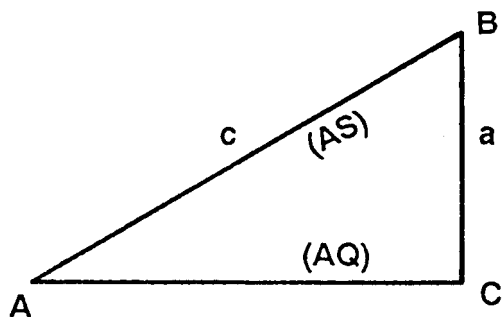
$$A = \pi r^2$$

or

$$A = \frac{\pi d^2}{4}$$

Page 10-3. Table 10-3. Change entry in last line, last column, to "118 lb."

Page 10-4. To the second paragraph under the subheading "Six Functions" add the following drawing:

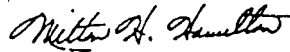


2. Post these changes according to DA Pamphlet 310-13.
3. File this transmittal sheet in front of the publication.

DISTRIBUTION RESTRICTION. Approved for public release; distribution is unlimited.

By Order of the Secretary of the Army:

Official:


MILTON H. HAMILTON
*Administrative Assistant to the
Secretary of the Army*
02181

GORDON R. SULLIVAN
*General, United States Army
Chief of Staff*

DISTRIBUTION:

Active Army, USAR, and ARNG: To be distributed in accordance with DA Form 12-11E, requirements for FM 5-33, Terrain Analysis (Qty rqr block no. 4329).



Natural Terrain

Chapter 1

SURFACE CONFIGURATION

Maneuver commanders must have accurate intelligence on the surface configuration of the terrain. Ravines, embankments, ditches, plowed fields, boulder fields, and rice-field dikes are typical surface configurations that influence military activities. Elevations, depressions, slope, landform type, and surface roughness are some of the terrain factors that affect movement of troops, equipment, and material.

Landforms

Landforms are the physical expression of the land surface. The principal groups of landforms are plains or plateaus, hills, and mountains. Within each of these groups are surface features of a smaller size, such as flat lowlands and valleys. Each type results from the interaction of earth processes in a region with given climate and rock conditions. A complete study of a landform includes determination of its size, shape, arrangement, surface configuration, and relationship to the surrounding area.

Relief

Local relief is the difference in elevation between the points in a given area. The elevations or irregularities of a land surface are represented on graphics by contours, hypsometric tints, shading, spot elevations, and hachures.

Slope or Gradient

Slope can be expressed as the slope ratio or gradient, the angle of slope, or the percent of slope. The slope ratio is a fraction in which the vertical distance is the numerator and the horizontal distance is the denominator. The angle of slope in degrees is the angular difference the inclined surface makes with the horizontal plane. The tangent of the slope angle is determined by dividing the vertical distance by the horizontal distance between the highest and lowest elevations of the inclined

surface. The actual angle is found by using trigonometric tables. The percent of slope is the number of meters of elevation per 100 meters of horizontal distance. Slope information that is available to the analyst in degrees or in ratio values may be converted to percent of slope by using a nomogram.

VEGETATION FEATURES

Plant cover can affect military tactics, decisions, and operations. Perhaps the most important is concealment. To make reliable evaluations when preparing vegetation overlays, analysts must collect data on the potential effects of vegetation on vehicular and foot movement, rover and concealment, observation, airdrops, and construction materials.

Types

The types of vegetation in an area can give an indication of the climatic conditions, soil, drainage, and water supply. Terrain analysts are interested in trees, scrubs and shrubs, grasses, and crops.

On military maps, any perennial vegetation high enough to conceal troops or thick enough to be a serious obstacle to free passage is classified as woods or brushwood. Although trees provide good cover and concealment, they can present problems to movement of armor and wheeled vehicles. Woods also slow down the movement of dismounted troops. Individual huge trees are seldom so close together that a tank cannot move between them, but the space between them is often filled by smaller trees or brush. Closely spaced trees are usually fairly small and can be pushed over by a tank; however, the resulting pileup of vegetation may stop the tank. Trees that can stop a wheeled vehicle are usually too closely spaced to bypass. The pileup effect from pushing over vegetation is greater for wheeled vehicles than for tanks.

Trees are classified as either deciduous (broadleaf) or coniferous (evergreen). With the exception of species growing in tropical areas and a few species existing in temperate climates, most broadleaf trees lose their leaves in the fall and become dormant until the early spring. Needleleaf trees do not normally lose their leaves and exhibit only small seasonal changes.

Woodlands or forests are classified according to the dominant local tree type. A forest is classified as either deciduous or coniferous if it contains at least 60 percent of that species. Wooded areas that contain less than a 60 percent mixture of either species are classified as a mixed forest.

Scrubs include a variety of trees that have had their growth stunted because of soil or climatic conditions. Shrubs comprise the undergrowth in open forests, but in arid and semiarid areas they are the dominant vegetation. Shrubs normally offer no serious obstacle to movement and provide good concealment from ground observation however, they may restrict fields of fire.

For terrain intelligence purposes, grass more than 1 meter high is considered tall. Grass often improves the trafficability of soils. Very tall grass may provide concealment for foot troops. Foot movement in savannah grasslands is slow and tiring; vehicular movement is easy; and observation from the air is easy.

Field crops constitute the predominant class of cultivated vegetation. Vine crops and orchards are common but not widespread, and tree plantations are found in relatively few areas. The size of cultivated areas ranges from paddies covering a quarter of an acre to vast wheat fields extending for thousands of acres.

In a densely populated agricultural area where all arable land is used for the crop producing the highest yield, it may be possible to predict the nature of the soils from information about the predominant crop. Rice, for example, requires fine-textured soils, while other crops generally must have firm, well-drained land. An area of orchards or plantations usually consists of rows of evenly spaced trees, showing evidence of planned planting. This can be distinguished on an aerial photograph. Usually such an area is free of underbrush and vines. Rice fields are flooded areas surrounded by low dikes or walls.

Some crops, such as grain, improve the trafficability of soils, while others, such as vineyards, present a tangled maze of poles and wires and create definite obstacles to vehicles and dismounted troops. Wheeled vehicles and some tracked vehicles are unable to cross flooded paddy fields, although they can negotiate them when the fields are drained and dry or frozen. Sown crops, such as wheat, barley, oats, and rye, will have a different impact on movement and concealment than those crops planted in furrows, because they are on a flat surface.

Photographic Texture

Texture is influenced by several variables, including crown shapes, tree spacing, and tree height. Texture interpretation as a means of identifying forest type requires knowledge of the texture often associated with each forest type. This knowledge is acquired through hands-on experience or the use of vegetation keys. With hands-on experience working with aerial imagery over along period of time and through the process of trial and error, an analyst can develop a mental catalog to relate texture in a given geographic area to a specific forest type.

Vegetation keys have been developed through the same trial and error process but have been documented and are available in the literature. They can be very useful in certain instances (see Chapter 3 for examples). However, one must remember that background knowledge of the area of interest is essential and most keys are specific to tree species, geographic area, time of year, film type, and photoscale. When using color or color infrared film, tone is often referred to as hue and is represented as shades of the color image.

Photographic Tone

Tone is also very important and is often applied to the problem of forest type identification. Tone is influenced primarily by stand density, reflectivity, and location of the tree stand with respect to the photographic center. When using panchromatic and black and white infrared film, photographic tone is represented by shades of gray. For example, in most regions of the world, needle leaf trees will appear darker in tone than broadleaf trees on panchromatic film given equivalent stand density. This tone difference is due to higher reflectivity of broadleaf trees in the region of the electromagnetic spectrum to which the film is sensitive.

SOIL FEATURES

Since soils vary in their ability to bear weight, their ability to withstand vehicle passes, and their ease of digging, military planners rely heavily on soil analyses. Soil type, drainage characteristics, and moisture content affect road construction, material location, and trafficability determination. The soil factor overlay breaks down the most probable soil types, characteristics, and distribution.

Describing and classifying soil normally requires exhaustive field sampling and the expertise of soil scientists. Terrain analysts, however, can produce acceptable soil factor overlays by examining maps, other factor overlays, aerial photographs, lab analyses, boring logs, and literature. The reliability of the resulting soil factor overlays will vary with the reliability of the sources used and the analyst's ability to correlate and combine the information correctly.

Determining whether a particular soil will support vehicle passage or the construction of roads and airfields is just a part of the terrain analyst's job. Since analysts also provide information on construction materials associated with roads and airfields, they need a variety of evaluation methods and a good working knowledge of the physical properties of soil.

Type Determination

For field identification and classification, soils may be grouped into five principal types: gravel, sand, silt, clay, and organic matter. These types seldom exist separately but are found in mixtures of various proportions, each contributing its characteristics to the mixture. Some soils may gain strength under traffic while others lose it.

Gravel is angular to rounded, bulky rock particles ranging in size from about 0.6 to 7.6 cm ($\frac{1}{4}$ to 3 inches) in diameter. It is classified as coarse or fine; well or poorly graded; and angular, flat, or rounded. Next to solid bedrock, well-graded and compacted gravel is the most stable natural foundation material. Weather has little or no effect on its trafficability. It offers excellent traction for tracked vehicles; however, if not mixed with other soil, the loose particles may roll under pressure, hampering the movement of wheeled vehicles.

Sand consists of rock grains from about 0.6 cm ($\frac{1}{4}$ inch) and smaller. It is classified as coarse, medium, or fine, and is angular or rounded. Well-graded angular sand is desirable for concrete aggregate and for foundation material. It is easy to drain and ordinarily not affected by frost action or moisture. Analysts must be careful, however, to distinguish between a fine sand and silt. When wet enough to become compacted or when mixed with clay, sand provides excellent trafficability. Very dry, loose sand is an obstacle to vehicles, particularly on slopes. Under wet conditions, remoldable sands react to traffic as to fine-grained soils. They feel somewhat plastic rather than gritty when rolled between the fingers.

Silt consists of natural reek grains. It lacks plasticity and possesses little or no cohesion when dry. Because of silt's instability, water will cause it to become soft or to change to a "quick" condition. When dry, silt provides excellent trafficability, although it is very dusty. However, it absorbs water quickly and turns to a deep, soft mud (a quick condition), which is a definite obstacle to movement. When

ground water or seepage is present, silt exposed to frost action is subject to ice accumulation and consequent heaving.

Clay generally consists of microscopic particles. Its plasticity and adhesiveness are outstanding characteristics. Depending on mineral composition and proportion of coarser grains, clays vary from lean (low plasticity) to fat (high plasticity). Many clays which are brittle or stiff in their undisturbed state become soft and plastic when worked. When thoroughly dry, clay provides a hard surface with excellent trafficability; however, it is seldom dry except in arid climates. It absorbs water very slowly but takes a long time to dry and is very sticky and slippery. Slopes with a clay surface are difficult or impassable, and deep ruts form rapidly on level ground. A combination of silt and clay makes a particularly poor surface when wet.

Chemically deposited and organic sediments are classified on the basis of mode and source of sedimentation. The identification of highly organic soil is relatively easy; it contains partially decayed grass, twigs, leaves, and so forth, and has a characteristic dark brown to black color, a spongy feel, and fibrous texture.

Classification

The terrain analyst uses the field classification technique to determine if the soil is fine or coarse or if it is remoldable sand. Usually the first two steps will determine the grain. If it is squeezed and rolled between the fingertips, fine-grained plastic soil will feel soft and smooth and should produce a ribbon or thread. Remoldable sands will feel coarser and more abrasive than a fine-grained material.

Unified Soil Classification System (USCS)

The Unified Soil Classification System uses a system of two-letter abbreviations to describe the soil. The primary letter identifies the predominant soil fraction. The secondary letter further describes the characteristics of the predominant soil fraction. The percent of gravel, sand, and fines provides the information necessary to choose the primary letter. See Figure 1-1.

Physical Tests

Before analysts classify soil, they must make four physical tests: gradation, liquid limit, plastic limit, and odor test.

Gradation, or grain-size distribution of a soil, is determined by a sieve analysis. A sieve analysis is the separation of soil into its fractions. It is made to determine gradation of material retained on a No. 200 sieve. It indicates whether a soil is well or poorly graded, and it will show the percentage of fines present. The sieve analysis may be performed directly on soils that may be readily separated from the coarser particles.

Sieves that military engineers commonly use have square openings and are designated as 2-, 1½-, 1-, ¾-, and ¼-inch sieves. They also use the US standard numbers 4, 10, 20, 40, 60, 100, and 200 sieves. See Figure 1-2 for an example of a sieve analysis.

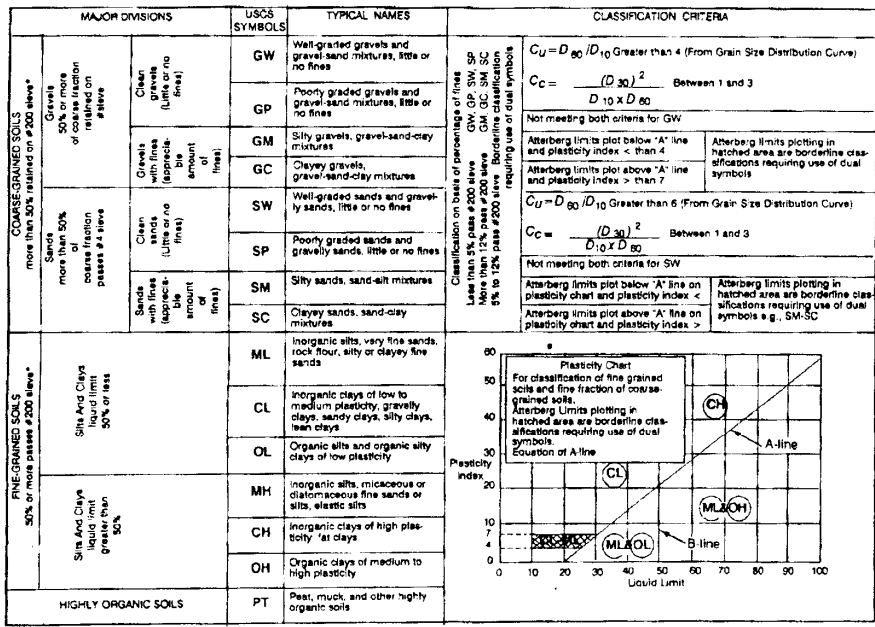
PRIMARY LETTERS

- G--Gravel

- S-Sand
 - C-Clay (Used only with fine-grained soil with 50% fines or greater)
 - M-Silt
 - O-Organic
- SECONDARY LETTERS
- W-Well graded (Used to describe sands containing less than 12% fines)
 - P-Poor graded
 - M-Silty Fines (Used with sands and gravels containing less than 5% but more than or equal to 50% fines)
 - C-Clay-based Fines
 - L-Low Compressibility (Used to describe fine-grained soils (silts, clays, organics))
 - H-High Compressibility

As soil becomes more moist, it transforms from a plastic to a liquid state. The liquid limit is the moisture content at which a soil will just begin to flow when jarred slightly. In conjunction with the plastic limit, it is valuable in proper identification and classification of fine-grained soils. The liquid limit is usually expressed as a whole number and is obtained by performing the Atterberg liquid limit test, which is outlined in TM 5-530.

The plastic limit is the moisture content at which cohesive soil passes from a semisolid to a plastic state. A soil or soil fraction is called plastic if, at some water



*Based on the material passing the 3-in (75-mm) sieve

Figure 1-1. Unified soil classification system criteria
1-6

SIEVE ANALYSIS

Submitted by SFC Delosier Date performed 10 Sep 1962
 Description of sample Yellow white gravelly sand with a small amount of Silt Fines
 Test performed by:
 1 SP-5 DILLON
 2 E-3 COKER
 3 _____
 4 _____
 5 _____
 Wt original sample 4000 gm
 Wt after prewashing 3855 gm
 Washing loss 135 gm $\frac{3955}{4000} \times 100 = 98.9\%$

Sieve or screen	Sieve Opening (mm)	Wt of sieve (gm)	Wt of sieve & sample (gm)	Wt. retained on sieve (gm)	Passing sieve	
					Weight in (gm)	Percent
				0	3964	100
2"	50.8	634.1	679.1	45	3919	98.9
1½"	38.1	598.9	649.9	51	3868	97.6
1"	25.4	540.9	646.9	106	3762	94.9
¾"	19.1	608.5	707.5	99	3663	92.4
⅜" (No 3)	6.35	488.5	1368.5	898	2765	69.8
No. 4	4.76	510.2	773.2	263	2502	63.1
No. 10	2.00	476.4	1254.4	778	1724	43.5
No. 40	0.42	377.9	1404.9	1027	397	17.6
No. 60	0.25	366.7	615.7	249	448	11.3
No. 100	0.149	320.6	456.6	136	312	7.9
No. 200	0.074	303.9	435.9	132	180	4.5
Wt retained in pan <u>45 gm</u> Washing loss <u>135 gm</u> Pan total <u>180 gm</u> Total weight of fractions <u>3964 gm</u>					Error=Original Wt - Total Weight of fractions $\frac{36}{3964} = 0.9\%$	

*Maximum particle size (measured)
 Prepared for use at USAES

Figure 1-2. Sieve analysis example

Note: Gravels will be retained at ¾ - to 2-inch sieves, sands at Numbers 4-100; all fines will be retained at the No. 200 sieve, allowing estimation of percentages of soil categories.

content, it can be rolled out into thin threads. The moisture content ranges between a soil sample's liquid and plastic limits. The larger the plasticity index, the more plastic the soil (PI = LL - PL). The percent of moisture content, by weight, at which a 1/8-inch diameter thread begins to crumble is expressed as a whole number when recorded

Since practically all fine-grained soils contain some clay, most of them will exhibit some amount of plasticity. Soil plasticity is determined by measuring the different states a plastic soil undergoes with changing moisture content. When a fine-grained soil or remoldable sand sample is rolled between two flat surfaces or between one's thumb and forefinger, it forms a thread. Highly plastic and nonplastic soils break into short lengths or cannot be formed into ribbons. In the field, analysts can examine the shape and mineral compositions of coarse-grained soil by spreading a dry sample on a flat surface, separating the gravel and fines as much as possible, and estimating the percentages of each. TM 5-530 gives further information.

Organic soils of the OL and OH groups usually have a distinct odor, which can be used to aid in identification. This color is especially apparent in fresh samples. It is gradually reduced when exposed to air, but can be brought out again by heating a wet sample.

Field Identification

Normally, laboratory equipment will not be available in the field, but analysts can estimate and tentatively classify without tests. Classifications made under stricter conditions will be more accurate. We classify soils by particle size distribution. Where these soil types occur and the amount of area they cover often determine the suitability of an area for military operations. In general, we prefer coarse-grained soils for construction and cross-country movements.

Well-graded and poorly-graded soils can usually be distinguished by comparing the sizes. Poorly-graded soils, however, are more difficult to classify because they lack one size particle. Principal aids to soil identification and classification are the shaking test, the dry strength or breaking test, and gully analysis.

Analysts performing the shaking test will alternately shake a wet portion of soil in the palm of the hand and squeeze between the fingers. Atypical inorganic silt will become livery, show free water to disappear from silt soil, and cause the sample to stiffen and crumble under increasing finger pressure. If the water content is just right, shaking the broken pieces will cause them to liquefy and flow together. The portion will change its consistency and the water on the surface will appear or disappear at a rapid, sluggish, slow, or no-reaction speed. A rapid reaction to this test is typical for a nonplastic, uniform fine sand, inorganic silt, or diatomaceous (algae-based) earths. A sluggish reaction indicates slightly plastic inorganic and organic silts, or very silty clays. An extremely slow or no reaction to the shaking test is typical for all clays that plot above the A-line on the plasticity chart as well as for highly plastic organic clays.

The dry strength test readily distinguishes between plastic clays and nonplastic silts or fine sands. Analysts perform the dry strength or breaking test only on a small portion of soil, about ½-inch thick and 1½ inches in diameter, that passes the Number 40 sieve. They prepare this by molding a portion of wet plastic soil into the size and shape desired and allowing it to air (NOT oven) dry. After the sample is thoroughly dry, they will attempt to break the soil using their thumbs and forefingers. If it breaks, they will try to powder it by rubbing the particles together. Typical reactions obtained in this test for various types of soil are--

- Very highly plastic soil, or very high dry strength. Samples cannot be broken or powdered by finger pressure.
- Highly plastic soil, or high dry strength. Samples will break with great effort, but they cannot be powdered.
- Medium plastic soil, or medium dry strength. Samples will break and powder with some effort.
- Slightly plastic soil, or low dry strength. Samples will break and powder easily.
- Nonplastic soil, or very little or no dry strength. Samples crumble and powder on being picked up.

Gullies, sometimes called head water channels, result from erosion caused by water runoff. They develop in places where water cannot easily filter into the ground; therefore, it collects and flows in rivulets across the land surface. Gully analysis can be of great assistance in determining soil types, since these rivulets often take the shape peculiar to the material over which they flow. Since fine-grained silts and clays are relatively impervious soils, many gullies develop on their surfaces. Sands and gravels are rather permeable, and few or no gullies form.

Other factors that govern the extent of gully formation in an area are climate, vegetation, ground slope, and gradient of individual gullies. Gradient is more important than intensity, or number, of gullies in revealing soil conditions. The types of gullies that may be formed in various soil types are--

- Gullies in clay. They have a long, uniform, gentle gradient and are smoothly rounded. Clay soils are impervious and cohesive and often have a well-developed gully system.
- Gullies in silt (primarily loess). They take the form of a U and have steep sides and generally flat bottoms. The gradient is steep at the head of the gully but becomes more gentle a short distance away.
- Gullies in sand-clay. They are similar to gullies in silts but are more U-shaped, with a rounded rather than flat bottom. The gradient is nearly vertical at the head of the gully but levels off rapidly to a very gentle slope.
- Gullies in gravel, sand, or well-graded mixtures with some clays. They are usually well-defined, short, straight notches (ditches). The cross section is a sharp V with a uniform gradient. The steeper gradients are associated with the coarser materials. See Figure 1-3.

WATER FEATURES

Safe water, in sufficient amounts, is strategically and tactically important to Army operations. Water that is not properly treated can spread diseases. The control of and access to water is critical for drinking, sanitation, construction, vehicle operation, and other military operations. Military planners are concerned with areas with the highest possibilities for locating usable ground water. They must consider all feasible sources and methods for developing sources when making plans for water supply. Quantity and quality are important considerations. Terrain analysts can use the methods and systems available to locate both surface and subsurface water resources.

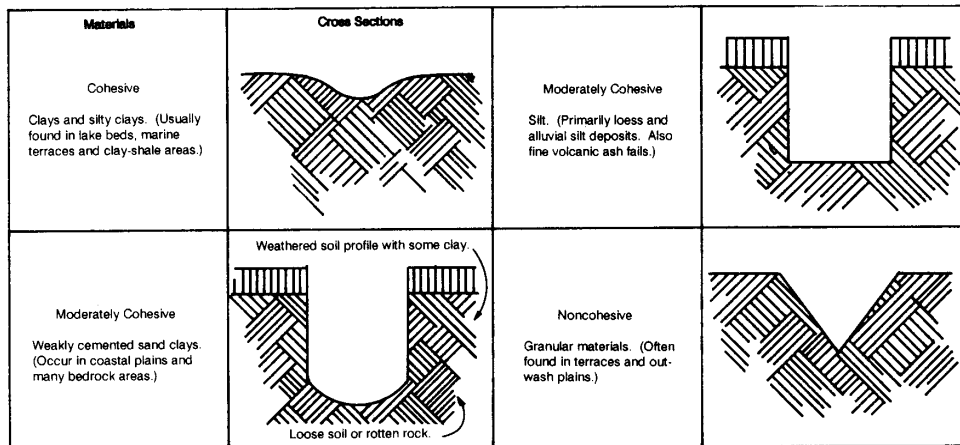


Figure 1-3. Gully profiles

Quantity

Water quantity depends on the climate of the area. Plains, hills, and vegetation are good indicators of water sources.

Large springs are the best sources of water in karstic plains and plateaus. Wells may produce large amounts if they tap underground streams. Shallow wells in low-lying lava plains normally produce large quantities of ground water. In lava uplands, water is more difficult to find, wells are harder to develop, and careful prospecting is necessary to obtain adequate supplies. In wells near the seacoast, excessive withdrawal of freshwater may lower the water table, allowing infiltration of saltwater that ruins the well and the surrounding aquifer.

Springs and wells near the base of volcanic cones may yield fair quantities of water, but elsewhere in volcanic cones the ground water is too far below the surface for drilling to be practicable. Plains and plateaus in arid climates generally yield small, highly mineralized quantities of ground water. In semiarid climates, following a severe drought, an apparently dry streambed frequently may yield considerable amounts of excellent subsurface water. Ground water is abundant in the plains of humid tropical regions, but it is usually polluted. In arctic and subarctic plains, wells and springs fed by ground water above the permafrost are dependable only in summer; some of the sources freeze in winter, and subterranean channels and outlets may shift in location. Wells that penetrate aquifers within or below the permafrost are good sources of perennial supply.

Adequate supplies of ground water are hard to obtain in hills and mountains composed of gneiss, granite, and granite-like rocks. They may contain springs and shallow wells that will yield water in small amounts.

Tree species can also indicate local ground water table presence. Deciduous trees tend to have far-reaching root systems indicating a water table close to the ground surface. Coniferous trees tend to have deep root systems, which depict the ground water table as being farther away from the ground surface. In desert environments, vegetation is scant and specialized to withstand the stress of desert life. Vegetation type is dependent on the water table of that location. Palm trees indicate water within 2 or 3 feet, salt grass indicates water within 6 feet, and cottonwood and willow trees indicate water within 10 to 12 feet. The common sage, greasewood, and cactus do not indicate water levels.

Quality

Quality will vary according to the source and the season, the kind and amount of bacteria, and the presence of dissolved matter or sediment. Color, turbidity, odor, taste, mineral content, and contamination determine the quality of water. Brackish water is found in many regions throughout the world but most frequently along sea coasts or as ground water in arid or semiarid climates.

Contamination

Potable water is free from disease-causing organisms and excessive amounts of mineral and organic matter, toxic chemicals, and radioactivity. Although surface water is ordinarily more contaminated than other sources, it is commonly selected for use in the field because it is more accessible in the quantity required. Ground water is usually less contaminated than surface water and is, therefore, a more desirable water source. However, the use of ground water by combat units is usually limited unless existing wells are available. Rain, melted snow, or melted ice may be used in special instances where neither surface nor ground water is available. Water from these sources must be disinfected before drinking.

Pollution

Water may be contaminated but not polluted. Streams in inhabited regions are commonly polluted, with the sediment greatest during flood stages. Streams fed by lakes and springs with a uniform flow are usually clear and vary less in quality than do those fed mainly by surface runoff. Generally, the quality of water in large lakes is excellent, with the purity increasing with the distance from the shore. Very shallow lakes and small ponds are usually polluted.

Porosity and Permeability

The water-bearing capability of a natural material is determined by porosity and permeability. The amount of porosity depends on the number of open spaces in the material. The permeability of rock is its capacity for transmitting a fluid. Rock types vary greatly in size, number, arrangement of pore spaces, and ability to contain and yield water. The amount of permeability depends on the degree of porosity, the size and shape of the interconnections between the pores, and the extent of the pore system. The geometric shapes of gullies can help identify the degree of permeability and porosity.

Drainage Surface

Most military problems involving surface water arise because stream drainage conditions vary not only from place to place but seasonally as well. Military planners are concerned with the flow and channel characteristics of surface waters and their effect on military operations. The water constitutes obstacles to cross-country movement or, when sufficiently frozen, it may provide movement. They also determine the types of equipment to be used in an area.

Drainage data on all of the surface water features is significant to any aspect of military operations. Commanders must know the width and depth of streams and canals; the velocity and discharge of streams; which areas are subject to flooding, or are permanently wet, densely ditched, or canalized; the location of dams; and any other drainage feature that may be significant.

Although surface drainage is considered a standard product, subsurface drainage is not. Potential ground water indicators include the following:

- Crop irrigation
- Karst topography
- Snowmelt patterns
- Wetlands
- Vegetation
- Springs
- Soil moisture
- Surface water
- Wells/Qanats
- Built-up areas (local municipalities and populus)

Surface water resources are generally more accessible and adequate in plains and plateaus than in mountains. Large amounts of good quality water can normally be obtained in coastal areas, valleys, or alluvial and glacial plains. Although large quantities are available in delta plains, the water may be brackish or salty. Water supplies are scarce on lacustrine, loess, volcanic, and karst plains. In the plains of arid regions, water usually cannot be obtained in quantities required by a modern army; much that is available is highly mineralized. In the plains and plateaus of humid tropical regions, surface water is abundant but is generally polluted and requires treatment. Perennial surface water supplies are difficult to obtain in arctic regions; in summer it is abundant but often polluted.

Subsurface

Ground water, or subsurface drainage, is obtained without difficulty from unconsolidated or poorly consolidated materials in alluvial valleys and plains, streams and coastal terraces, glacial outwash plains, and alluvial basins in mountainous regions. Areas of sedimentary and permeable igneous rocks may have fair to excellent aquifers, although they do not usually provide as much ground water as areas composed of unconsolidated materials. Large amounts of good-quality ground water may be obtained at shallow depths from the alluvial plains of valleys and coasts and in somewhat greater depths in their terraces. Aquifers underlying the surface of inland sedimentary plains and basins also provide adequate amounts of water. Abundant quantities of good-quality water generally can be obtained from shallow to deep wells in glacial plains. In loess plains and plateaus, small

amounts of water may be secured from shallow wells, but these supplies are apt to fluctuate seasonally. Well water is usually clear and low in organic impurity but may be high in dissolved mineral content.

Patterns

The pattern of stream erosion usually gives an indication of rock structure and composition and an indication of whether the region is underlined by one or several rock types. The pattern can be dendritic, trellis, radial, annular, parallel, or rectangular.

The dendritic drainage pattern is a tree-like pattern composed of branching tributaries to a main stream, characteristic of essentially flat-lying and homogeneous rocks. This pattern implies that the area was originally flat and is composed of relatively uniform materials. Dendritic drainage is also typical of glacial till, tidal marshes, and localized areas in sandy coastal plains. The difference in texture or density of a dendritic pattern may help identify surface materials and organic areas.

In a trellis pattern, the mainstream runs parallel, and small streams flow and join at right angles. This pattern is found in areas where sedimentary or metamorphic rocks have been folded.

In a radial pattern, streams flow outward from a high central area. This pattern is found on domes, volcanic cones, and round hills. However, the sides of a dome or volcano might have a radial drainage system while the pattern inside a volcanic cone might be centripetal, converging toward the center of the depression.

The annular pattern is a modified form of the radial drainage system, found where sedimentary rocks are upturned by a dome structure. In this pattern, streams circle around a high central area. The granitic dome drainage channels may follow a circular path around the base of the dome when it is surrounded by tilted beds.

In the parallel pattern, major streams flow side by side in the direction of the regional slope. Parallel streams are indicative of gently dipping beds or uniformly sloping topography. The greater the slope, the more nearly parallel the drainage and the straighter the flow. Local areas of lava flows often have parallel drainage, even though the regional pattern may be radial. Alluvial fans may also exhibit parallel drainage, but the pattern may be locally influenced by faults or jointing. Coastal plains, because of their slope toward the sea, develop parallel drainage overboard regions.

The rectangular drainage pattern is a specific type of angular drainage and is usually a minor pattern associated with a major type such as dendritic. This pattern is characterized by abrupt bends in streams and develops where a tree-like drainage pattern prevails over a broad region. It is caused by faulting or jointing and is generally associated with massive igneous rock. Metamorphic rock surfaces, particularly those comprised of schist and slate, commonly have rectangular drainage. Slate possesses a particularly finely textured system. Its drainage pattern is extremely angular and has easily recognizable short gullies that are locally parallel.

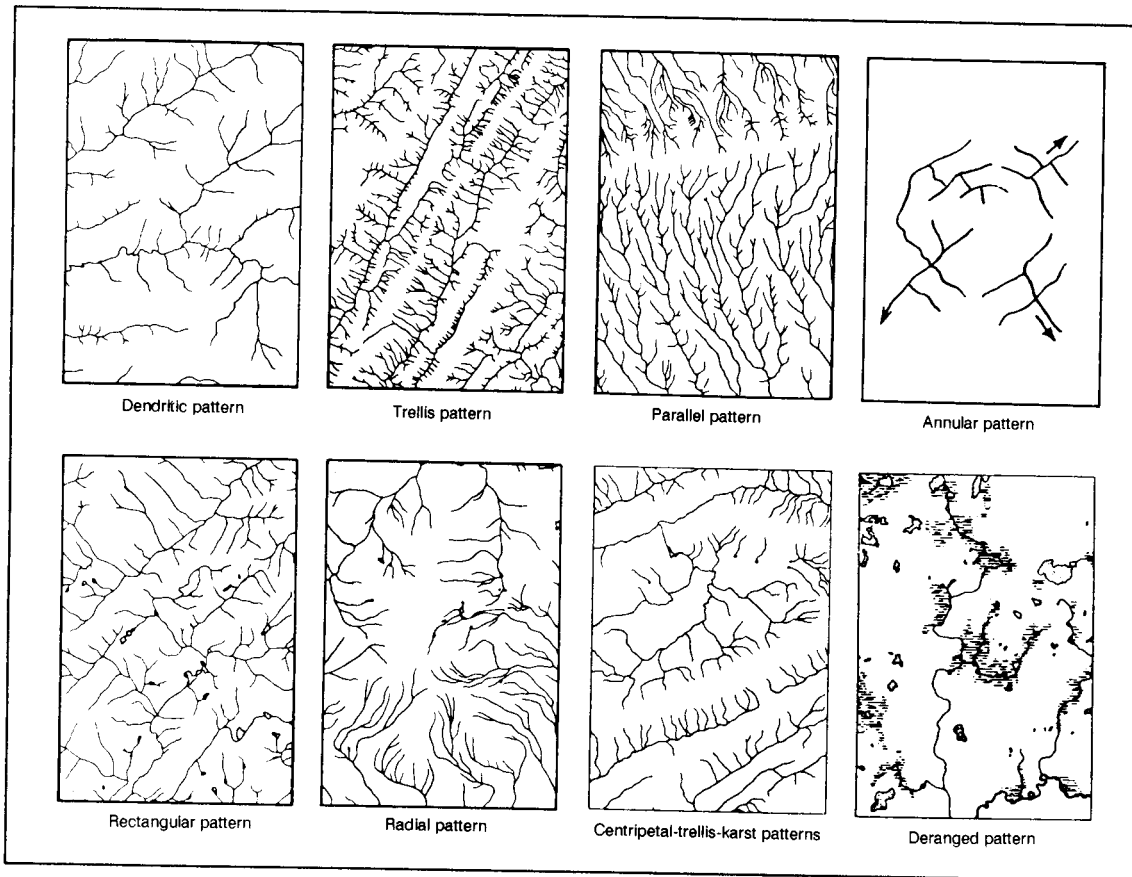


Figure 1-4. Typical drainage patterns

Density

A determination of the density of the drainage pattern, or the number of streams in a precise area, is very beneficial. The nature of the drainage pattern in an area will provide a strong indicator of the particle size of the soils that have developed.

Surface sediments have good internal drainage. Sandstone, for example, due to its porosity and permeability, has good internal drainage. Water can usually percolate down through the soil and underlying rock, and the surface runoff will be at a minimum. The texture or density of the drainage pattern that develops on sandstone will be coarse.

A porous rock is not necessarily permeable. Clay, for example, contains up to 90 percent water and is very porous but is not permeable because of the nature of its flat-lying particles.

Sands and gravels are usually both porous and permeable, depending on sorting. When precipitation occurs, some of the water can percolate down through the sediment.

Shale is a relatively impermeable rock and has poor internal drainage. Surface runoff will be at a maximum, and erosion will often be intense. The texture or density of the drainage pattern that develops on shale will be fine-textured. See Figure 1-4.

OBSTACLES

Classification

An obstacle is any natural or man-made terrain feature that slows, diverts, or stops the movement of personnel or vehicles. Obstacles are classified as natural, such as escarpments, or man-made, such as built-up areas and cemeteries. They are further categorized as existing-present natural or as man-made terrain features that will limit mobility or as reinforced-existing features that man has enhanced to use as obstacles, such as gentle slopes reinforced by tank ditches, pikes, or revetments that limit mobility of maneuver units.

For classification purposes, obstacles must be at least 1.5 meters high and 250 meters long and have a slope greater than 45 percent (that which military vehicles are unable to travel). Obstacles that will be delineated should be in areas where they are of primary importance for the diversion of crosscountry movement. Obstacles include escarpments, embankments, road cuts and fills, depressions, fences, walls, hedgerows, and moats.

An obstacle factor overlay portrays linear terrain features that form natural obstacles not normally identifiable on a topographic map. Obstacles located in areas of dense forest, on steep slopes (greater than 45 percent), or within the gap width of streams normally will not be shown on the obstacle overlay. Hydrologic obstacles such as drainage ditches, channelized streams, and water banks are shown on the surface drainage overlay.

Identification

Escarpments are terrain features similar to cliffs and ridges and appear on aerial photographs as sharp breaks in the slope separating near level or gently sloping surfaces. They are hazardous to both troop and vehicle movement due to the sharp drop in the land typical of cliffs and ridges. Embankments are artificial structures, usually of earth or gravel, constructed above natural ground surfaces such as dikes, levees, and seawalls. Escarpments and embankments are tactically significant because explosive devices can make the road, railroad, or cross-country route impassable and because they can be used as channelization factors. This is especially true if the bypass capability is restrictive to the state of the ground.

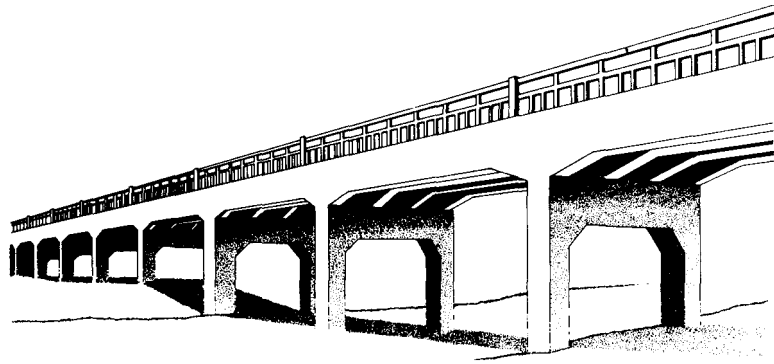
Railroad and road cuts and fills restrict military movement. Cuts are thoroughfares or passages constructed through high areas. Fills are surfaces that have been built up or raised to bring a low area up to the same level as the surrounding surfaces.

Depressions are low points or sinkholes surrounded by higher ground. They usually have slopes equal to or greater than 45 percent, which will impede movement across the terrain. Pits, quarries, and sinkholes are typical examples of depressions.

Man-made features include fences or walls, hedgerows, and moats. Fences and walls are usually constructed to separate or restrict crossings from one plot of land to another. Hedgerows are tree-type barriers that can be identified by looking for closely spaced rows of trees or bushes planted on a mound. They are so dense that they restrict vehicle movement.

European vineyards offer an excellent example of obstacles, due to the wet state of the ground and the wire used to support crop growth. Combined with the existing terrain, vineyards cause extreme difficulty in cross-country mobility.

Finally, moats are landforms that appear on photos as wide trenches or ditches which usually surround a structure or prominent feature and are inaccessible to vehicles. Moats are generally restricted to the British or European areas. Preliminary identification can be made by referring to the map legend on a topographic map.



Man-Made Features

Chapter 2

URBAN AREAS

Urban-area intelligence is important in planning tactical and strategical operations, targeting for nuclear or air attack, and planning logistical support for operations. Knowledge of characteristics in urban areas may also be important in civil affairs, intelligence, and counterintelligence operations. Although information is frequently accessible, the amount of detail required necessitates a substantial collection effort.

The first aspect of urban intelligence includes geographic location, relative economic and political importance of urban areas in the national structure, and physical dimensions such as street shapes. The six street patterns are rectangular, radial, concentric, contour conforming, medieval irregular, and planned irregular (in the new residential suburbs of some countries).

The second aspect includes physical composition, vulnerability, accessibility, productive capacity, and military resources of individual urban areas. Urban areas are significant as military objectives or targets and as bases of operations. They may be one or a combination of power centers (political, economic, military); industrial production centers; service centers; transportation centers; population centers; service centers (distribution points for fuels, power, water, raw materials, food, manufactured goods); or cultural and scientific centers (seats of thought and learning, and focal points of modern technological developments).

Buildings can provide numerous concealed positions for the infantry. Armored vehicles can find isolated positions under archways or inside small industrial or commercial structures. Thick masonry, stone, or brick walls offer excellent protection from direct fire, and ceilings for individual fire. Cover and concealment can also be provided by the percentage of roof coverage. For detailed information, see FM 90-10.

Although an urban overlay is not a standard product, it is useful for military purposes. A subdivision can describe individual categories or break down a division to more specific items as required by the user, as long as the subdivisions are outlined in the legend. The division numbers in this manual are based on the DFAD system, in PS/ICE/200. The first number describes the division as residential or industrial, the second number indicates the type of construction material,

and the third number is the type of structure. If this number or its subdivisions are not needed in particular overlays, the number will be followed by zeros.

The industrial category (code 100) consists of the area and facilities that include the buildings used by those establishments engaged in the extraction, processing, and production of intermediate and finished products or raw materials. The two plant types in industrial areas are heavy manufacturing and medium and light manufacturing. Heavy-manufacturing plants require distinctive structures, such as blast furnaces, that could be readily recognized, while medium and light plants are housed in general loft buildings from which machinery could be removed. The specific type of medium-or light-manufacturing plant is not usually apparent from the type of building.

The transportation category (code 200) consists of the area and facilities used in moving materials and people on land. Features include railroads, roads, road interchanges, bridges, bridge structures, and conduits.

The commercial/recreational category (code 300) consists of the area and buildings where the major business activities and recreational facilities comprise the congested commercial core of a city. It includes retail and wholesale establishments, financial institutions, office buildings, and hotels. Modern multistory office buildings are typical of commercial sections of large cities. More than one commercial area may exist, particularly in cities where a number of towns have merged. Recreational activities, such as amusement parks and stadiums, may also be present.

Residential areas of a city (code 400) consist of the area and associated buildings where civilians live. They include many types of dwelling structures. Buildings vary from one and two-story single family dwellings to multistory apartment houses and may be built of any materials available locally. Types and sizes of residential areas often indicate the number of people and the varying living standards throughout the city.

Communication facilities (code 500) transmit information from place to place. This category includes telephone, telegraph, and radio facilities, as well as other electronic features such as power line pylons and structures. These facilities include communication towers and buildings, as well as power transmission, observation, microwave, television, and radio towers.

The governmental and institutional category (code 600) consists of the area and facilities, primarily buildings, that constitute the seat of legal, administrative, or other governmental functions of a country or political subdivision. This category includes those buildings serving as public service institutions, such as universities, churches, and hospitals. Governmental and institutional areas may include buildings such as the capital; administrative centers such as ministries, departments, courts, legislative buildings, embassies, and police headquarters; educational, cultural, and scientific institutions such as schools, hospitals, universities, libraries, museums, theaters, research institutions and laboratories; and religious and historic structures such as churches, monuments, and shrines.

The military/civil category (code 700) consists of the area and facilities used by the air, naval, and ground forces for waging war, training, and transporting

nonmilitary goods and personnel by sea and air. Military areas usually include transportation, billeting, storage, airfields, and administration facilities. Since these are of strategic and tactical importance, they require as accurate a description as possible for urban-area intelligence.

The storage category (code 800) consists of the area and facilities used for holding or handling liquids or gases, bulk solids, and finished products. Examples are cylindrical and spherical storage tanks; closed storage such as silos and grain bins; open storage such as vehicle, ship, and aircraft storage areas and storage mounds such as coal or minerals.

The landforms, vegetation, and miscellaneous features category (code 900) describes the surface landscape characteristics or natural scenery features such as levees, walls, and fences. It includes beaches, recreation areas, farms, wooded areas, swamps, and vacant land. Extensive open areas within the city may be valuable military assets, particularly if they have roads and railroad lines nearby as well as access to electric and water supply facilities. Open areas on the outskirts of cities are the most immediately available land for military use. Features include snow or ice areas, vegetation such as orchards and vineyards, agricultural areas, and surface features such as embankments, fences, and cliffs.

TRANSPORTATION

Analysts preparing terrain studies must carefully evaluate all transportation facilities to determine their effect on proposed operations. Analysts may recommend destroying certain facilities or retaining them for future use. The entire transportation network must be considered in planning large-scale operations. An area with a dense transportation network, for example, is favorable for major offensives. Networks that are criss-crossed by canals and railroads and possess few roads will limit the use of wheeled vehicles and the maneuver of armor and motorized infantry.

The transportation facilities of an area consist of all highways, railways, and waterways over which troops or supplies can be moved. The importance of each area depends on the nature of the military operation involved. An army's ability to carry out its mission depends greatly on its transportation capabilities and facilities.

Highways

Features

Military interest in highway intelligence of a given area or country covers all physical characteristics of the existing road, track, and trail system. All associated structures and facilities necessary for movement and for protection of the routes, such as bridges, ferries, tunnels, and fords, are integral parts of the highway system. Planners must know where new routes will be needed to support an operation.

Road widths are given in meters. Measurements indicate the minimum width of the traveled way. Each road segment between intersections is assigned a width value, and that number is placed parallel to the road segment.

The severe abuse given to roads by large volumes of heavy traffic, important bridges, intersections, and narrow defiles makes them primary targets for enemy

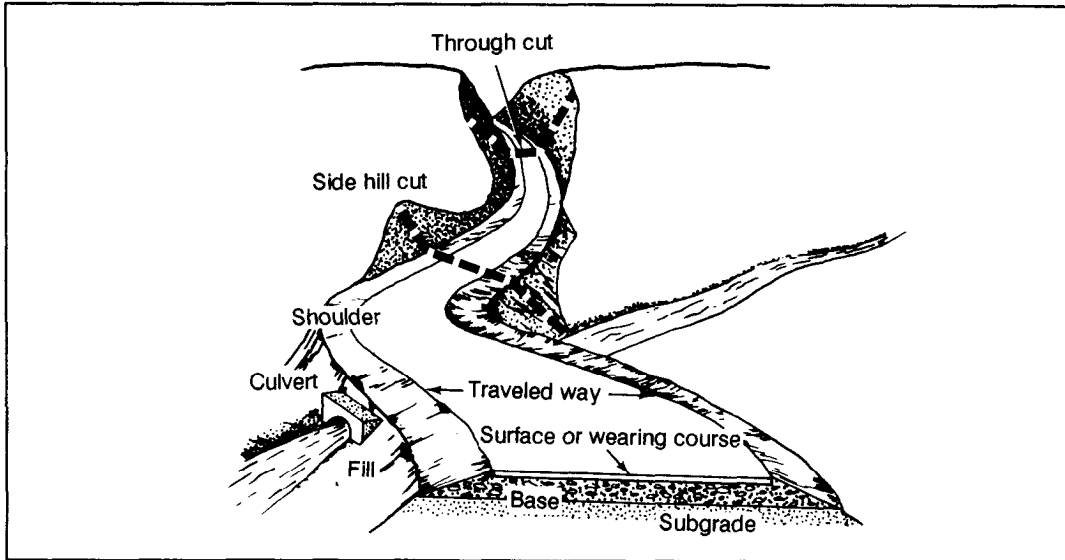


Figure 2-1. Parts of a road

bombardment. Planners must avoid maintaining unnecessary routes and must hold construction of new routes to a minimum.

Road Classification

Five road classifications are recognized on 1:50,000 scale topographic maps. They are all-weather, hard-surface dual/divided highway; all-weather, hard-surface highway; all-weather, loose-surface highway; fair-weather, loose-surface highway; and cart track.

All-weather, hard-surface, dual/divided highways normally have waterproof surfaces paved with concrete, bituminous surfacing, brick, or paving stone and are only slightly affected by precipitation or temperature changes. The route is never closed to traffic by weather conditions other than temporary snow or flood blockage. Photo interpretation keys include:

- Traveled portion of roadway is fairly straight.
- Even curves are present.
- Road width is uniform with easily seen parallel sides.
- Photo tint of road surface is an even color and varies from dark gray to white.
- Absence of ruts or holes on traveled portion of the roadway.

All-weather, hard-surface highways have waterproof surfaces of concrete, bitumen, brick, or paving stone and are only slightly affected by rain, frost, thaw, and heat. They are passable throughout the year to a volume of traffic never appreciably less than its maximum dry-weather capacity. They are never closed by weather conditions other than temporary snow or flood blockage. Photo interpretation keys are similar to those for the dual or divided highway.

All-weather, loose-surface highways are not waterproof but are graded and drained and are considerably affected by rain, frost, or thaw. They are constructed of crushed rock, water-bound macadam, gravel, broken stone and cinders, or

smoothed earth with an oil coating. The roads are kept open in bad weather to a volume of traffic considerably less than its maximum dry-weather capacity. Traffic may be halted for short periods of time. Heavy use during adverse weather conditions may cause complete collapse. Photo interpretation keys include:

- Sharp or irregular curves are present.
- Roadway meanders to avoid steep slopes.
- Gravel or crushed rock appears a uniform light gray except for low spots that collect water and appear in dark tones.
- Ruts and stones give the roadway a mottled appearance.
- Roadway edges and shoulders are not clean, sharp lines; sometimes, they are very difficult to determine.

Fair-weather, loose-surface highways are constructed of natural or stabilized soil, sand clay, shell, cinders, or disintegrated granite or rock. They include logging roads, abandoned roads, and corduroy roads which become quickly impassable in bad weather. Photo interpretation keys are similar to those for the all-weather, loose-surface highway except for less visible maintenance and narrower road widths at stream crossings.

Cart tracks are natural traveled ways including caravan routes and winter roads. They are not wide enough to accommodate four-wheeled military vehicles. Photo interpretation keys include

- Irregular turns and bends.
- Traveled roadway width varies.
- Apparent lack of direction.
- Roadway detours around wet terrain.

Railroads

Railways are a highly desirable adjunct to extended military operations. Their capabilities are of primary concern and are the subject of continuing studies by personnel at the highest levels.

Railroads include all fixed property belonging to a line, such as land, permanent way, and facilities necessary for the movement of traffic and protection of the permanent way. They include bridges, tunnels, snowsheds, galleries, ferries, and other structures.

Commanders need information on physical characteristics to determine railway capacities and maintenance or rehabilitation requirements. Railway intelligence covers all physical characteristics of the existing system and all available information pertaining to development, construction, and maintenance. Physical characteristics describe the railroad and its critical features and component parts such as roadbed, ballast, track, rails, and horizontal and vertical alignment.

Identification Keys

Railroads have definite characteristics distinguishing them from roads and highways (see Figure 2-2). Railroads often follow rivers, to take advantage of the normal gradual gradient of the valley. They follow as straight a line as possible, while roads meander. Curves are usually long and smooth, while roads may have sharp, right-angle turns and T-shaped intersections.

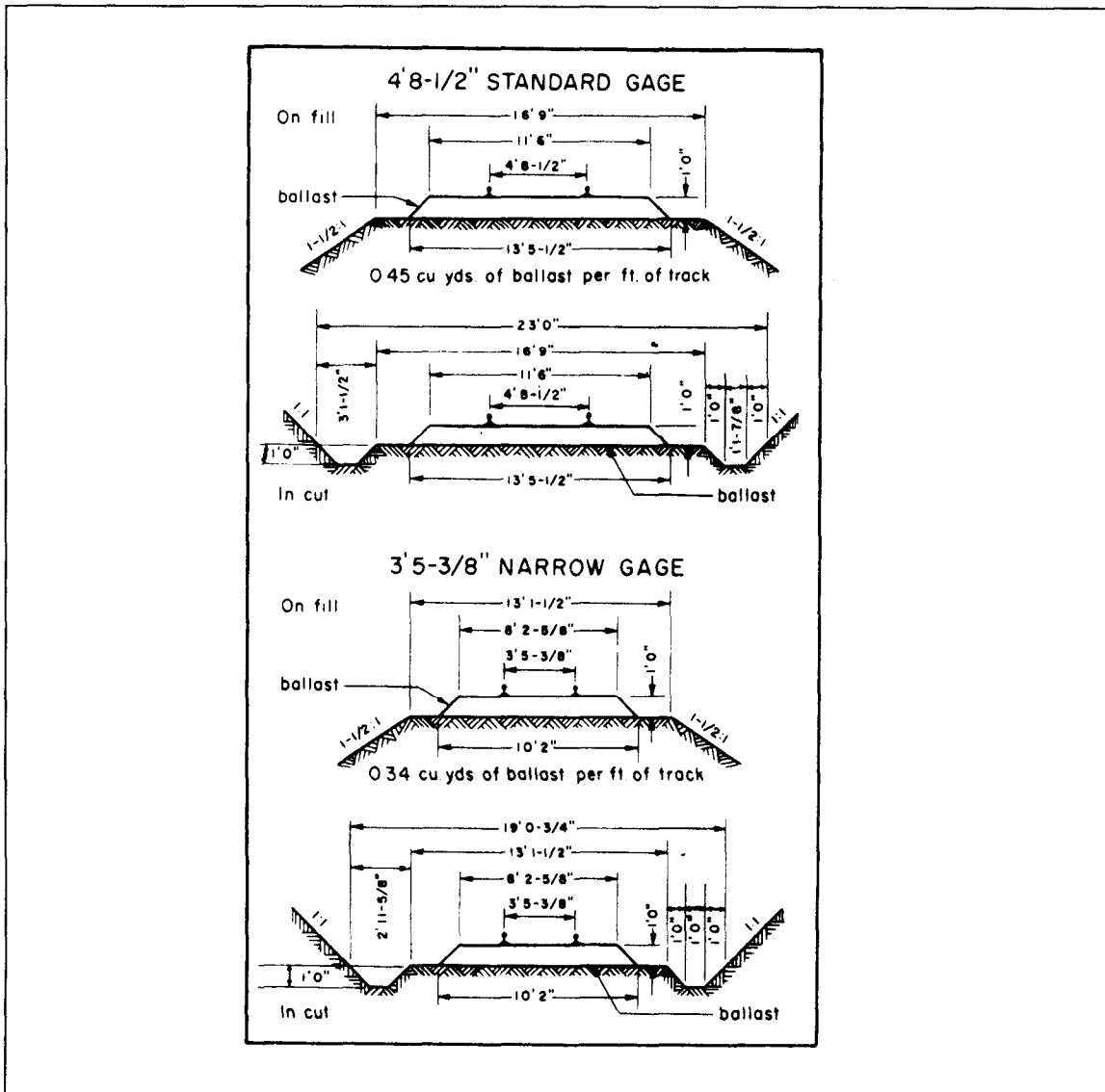


Figure 2-2. Diagram of standard- and narrow-gage roadbed cross section

Gradients are as level as possible and seldom exceed more than three or four percent, while roads often have steep grades. In order to keep gradients at a minimum, many cuts and fills exist along the right-of-way, especially in rolling or broken terrain, while roads run up and down hills with fewer cuts and fills.

Few houses are found along railways. Highways and railroads cross each other in such a manner that no interchange of traffic is possible. Grade crossings have distinct intersection angles, and overpasses and underpasses are obvious.

The gage of a railroad is the distance between the rails. Knowledge of railroad gages is useful to image interpreters for determining photo scales. Also, knowing that a change in gage may occur at an international border, the interpreter should look for transshipment stations. Railroad gages are classified as wide, standard, or

narrow. Wide gages are 5 feet or wider. They are mostly used by Russian, Finnish, and Spanish lines. Standard gages are 4 feet, 8½ inches. They are used for main and branch lines in the United States and the rest of Europe. Narrow gages are less than standard. Their use is somewhat limited to and usually found in mountainous, industrial, logging, and coastal defense areas and in mines and supply dumps. In South and Central America, the one-meter gage is found in many places; however, many of the countries are now adopting the standard gage because they import US-made rolling stock. See Figure 2-2.

Fixed Installations

Classification (marshaling) yards are used to sort freight cars. They are identified by a large group of parallel tracks with a restricted (one-or two-track) entrance and exit called a choke point. Active classification yards include numerous freight cars and small switch engines. Two or more classification yards are frequently found next to each other, with their entrances through a choke point. If this choke point is higher than either classification yard, it is known as a hump. Also, one yard is often placed slightly higher than the neighboring yard to allow cars to coast out of one yard through the choke point into a previously selected track of the other yard.

Service yards are normally found in or near marshaling yards and can be identified by the presence of roundhouses, turntables, service facilities, and car repair shops. Roundhouses are used for light repair and storage of locomotives. The number of roof vents on top of the roundhouse indicates the capacity of the roundhouse. Turntables are used for turning the engines around. Service facilities include coal towers, water towers, and coal piles. Car-repair shops normally appear as long, low buildings straddling one or more tracks, with cars awaiting repairs on sidings adjacent to the buildings.

Freight or loading yards are identified by loading platforms, freight stations, warehouses, and access to other means of transportation. Special loading stations are identified by grain elevators, coal and ore bins, oil storage tanks, and livestock pens with loading ramps.

Passenger stations vary from small rural depots or suburban stations to large stations and terminals. Small stations usually do not have loading docks and may not have parking areas for automobiles or trucks. They are located close to a track, and shelters may cover waiting platforms if more than two tracks pass the station. Large stations are identified by a large number of tracks leading into or past a large building that houses waiting rooms, ticket offices, and other passenger facilities. The track or boarding area is normally covered.

Freight stations may be identified by loading docks along railroad tracks on one side of a building and loading docks along a road or street on the opposite side. Freight stations are small, single structures near passenger stations designed for the temporary storage of goods received. Warehouses may be away from fixed railroad installations, and more than one may be located in an area. Freight cars loading or unloading at a freight station aid in identification of the installation. See Figure 2-3.

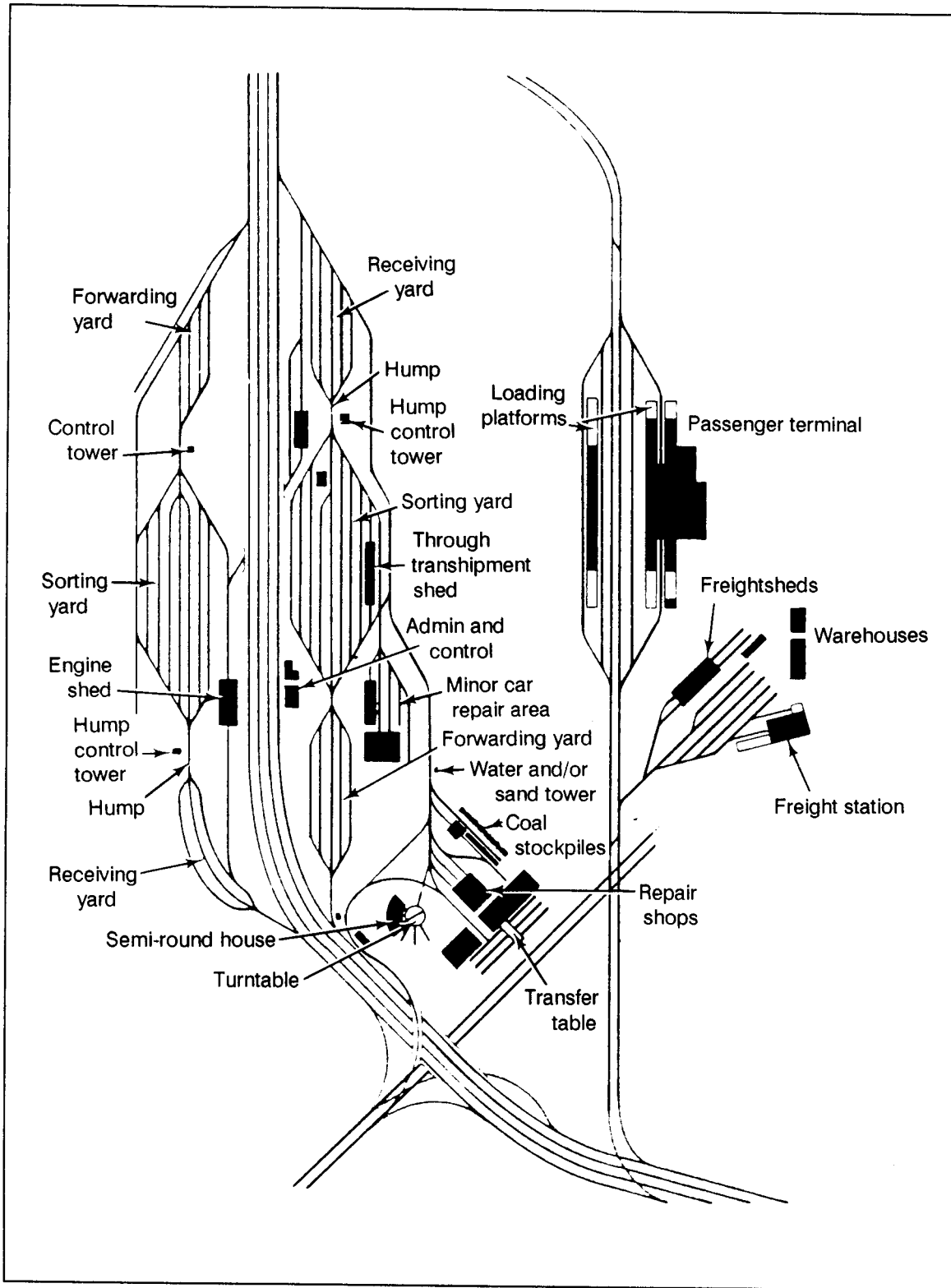


Figure 2-3. Fixed Installations

Rolling Stock

Locomotives. Locomotives vary greatly, from small switch engines 24 to 30 feet long in mainline passenger and freight locomotives 35 to 50 feet long. Locomotives longer than 50 feet are used for special purposes such as mountain climbing. Locomotives may be steam, electric, diesel, or diesel-electric. Steam locomotives are easily identified by smoke and steam around an operating locomotive, a smokestack, and a fuel tender attached just behind the locomotive. Electric locomotives have no fuel tender or smokestack and may be identified by overhead antennae if they receive their power from overhead lines. The lines may be evidenced by the shadows their support poles cast. Diesel locomotives lack a fuel tender and are usually identified by their streamlined appearance.

Freight cars. The boxcar is the most frequently found freight rolling stock, recognized by its rectangular shape and little roof detail. The round-topped freight car differs only in its top. These cars average 40 to 45 feet in length in the US, 25 feet in Europe. Other freight cars are the gondola and hopper cars, which are used for coal, ore, and other bulky material or large freight that cannot be loaded into a boxcar. Shape and shadow aid in identification. Refrigerator, stock, and automobile cars are so close in appearance to boxcars that low-level obliques are usually necessary to distinguish them. Caboose, not always found on foreign railroads, appear as small cars attached to the end of freight trains, usually with a visible cupola.

Passenger cars. For identification purposes, the outstanding characteristic of passenger cars is their length, especially when compared with freight cars. They vary from 50 to 80 feet. Normally, it is not possible to distinguish a coach from a sleeping or dining car.

Special Equipment. Railroads have a variety of special equipment in their rolling stock. The railcar is a self-contained unit with its own power plant as well as space for passengers or mail and baggage or all three. Cranes, snowplows, and drop-center flatcars are sometimes present on rolling stock.

Railheads

Railheads are points of supply transfer from railroads to other transportation and are generally found in small towns or cities where sidings and storage space already exist. Characteristics of a railhead are spurs and sidings from a main line; a road net, including narrow gage railroads, leading away from the area; piles of materials stacked near the track trucks or wagons or both, either without order or organized into convoys or trains; and temporary dwellings, such as tents or Quonset huts, for housing troops guarding and handling supplies.

End Points

System. A railroad system is a network of railroads operated by a single management entity, government or corporate. System end points are the points where a railroad system begins, ends, or changes identification. There may be no system end points within many map sheets, but system end points will always coincide with route and segment end points.

Route. A route is the portion of a system providing through lines between selected points. Routes are usually specified by the system management, but it

may often be convenient or appropriate for the analyst to select others. The route will be identified on the factor overlay by abbreviations of the two endpoints placed in parentheses. There may be no route end points within the area of a 1:50,000 factor overlay. Route end points always coincide with segment end points and may coincide with system end points. Kilometer distances are always measured from route end points.

Segment. A segment is the portion of a route characterized by uniform load-bearing, traffic capacity, and operating characteristics. Analysts will number segments sequentially along a route within a map sheet, starting at the segment nearest the zero kilometer point. End points of segments are defined by nodes along the route, at which anyone of the following conditions occurs:

- A change in the number of tracks (points where passing tracks or sidings start or end do not constitute nodes).
- A change in the gage of the track.
- A route or system terminal.
- The point where the route crosses the neat line of the factor overlay.
- A terminal or junction where traffic may be diverted onto another route.
- A change in the type of construction such that the load-bearing capacity, speed or traffic capacity is altered.
- A point where electrification starts, ends, or changes method of power transfer.
- A point where a change in traffic control methods occurs, such as international boundary crossings.

Number of Tracks

Analysts indicate the number of tracks for single- and double-track lines by the number of ticks used with the gage symbol. Routes with three or more tracks are symbolized by the double-track symbol supplemented by a *T* and a number, which indicates the actual number of tracks. Lines operated by different systems that closely parallel each other or share a common right-of-way are in juxtaposition (side by side) and are indicated by separate symbols. Symbols for such lines will be sufficiently displaced from the centerline to make it clear that two distinct lines exist.

Bridges

Features

Structures and crossings on highways or railways include bridges, culverts, tunnels, galleries, ferries, and fords. For the purpose of terrain intelligence, they also include cableways, tramways, and other features that may reduce or interrupt the traffic flow on a transportation route. Bridges and culverts are the structures most frequently encountered; however, any feature that may present a potential obstacle is significant in a military operation. See Figure 2-4.

Any type of structure or crossing on a transportation route is an important portion of the route regardless of the mode of transportation. Maps, charts, photographs, and other sources contain valuable information that analysts should exploit.

Highway and railway bridges and tunnels are vulnerable points on a line of communications. Information about prevention, destruction, or repair of a bridge may be the key to an effective defense or the successful penetration of an enemy


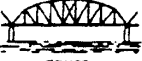




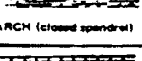
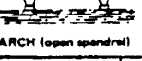

Structure Type	Span Type	Photo Indication	Photo Tone/Color/texture	Probable Material Type
Bridge	 SUSPENSION BRIDGE	Towers Shadow outline of towers and suspension cables. Texture of tower surfaces.	Color: green, red, black Tone: dark gray	Steel reinforced concrete
	 TRUSS	Presence of superstructure cross hatch pattern of span members, detail visible from shadow detail.	Color: white, gray, red, silver Tone: light to dark gray Texture: rivet pattern	Steel
	 SLAB	Absence of superstructure Type of guard rails: (1) Angular (2) Rounded, smooth	Beam, girder, and slab bridge design preclude identification of construction material from vertical aerial photography. When possible the analyst should obtain low oblique photography of these types of bridges.	
	 BEAM	Absence of superstructure Type of guard rails: (1) Angular (2) Rounded, smooth, length		
	 GIRDER	Absence of superstructure Type guard rails: (1) Angular (2) Rounded, smooth, length, shadow detail		
	 ARCH (closed span) arch	Shadow detail: massive structure	Color: white, red Tone: gray, light gray Texture: rough Joint patterns	Masonry structures are massive and usually old. Reinforced concrete spans are smaller.
	 ARCH (open span) arch	Shadow detail: open structure, smooth, rounded span members	Color: white to light gray Tone: gray to light gray Texture: smooth	Smooth rounded span Members: reinforced concrete Angular span members: steel
Snowshed		Location: Mountainous areas Length	Color: light gray to white Tone: light gray Texture: smooth	Difficult to determine from vertical photo. Long structures (100m) are probably reinforced concrete.
Gallery		Location: limited to Mountain sides and valleys. Rock and landslide indications in area.	Roof materials not indicative of material.	Recent construction: reinforced concrete. Old structure: wood

Figure 2-4. Structure construction type identification from vertical aerial photography

area. A bridge seized intact has great value in offensive operations, since even a small bridge eases troop movement over a river or stream.

A bridge includes the substructure and superstructure. The substructure comprises the foundation and supporting elements of a bridge; the superstructure is the assembly that rests on the substructure and spans the gaps between ground supports.

Bridge superstructures take many forms, ranging from short trestle spans built into wooden stringers to large multiple cantilever spans of several thousand feet. Most have two basic components, the main supporting members and a floor or deck system. The primary exception is the concrete slab design, in which the supporting member also serves as the floor. The superstructure used depends on the loads to be carried, required span lengths, time available for erection, availability of

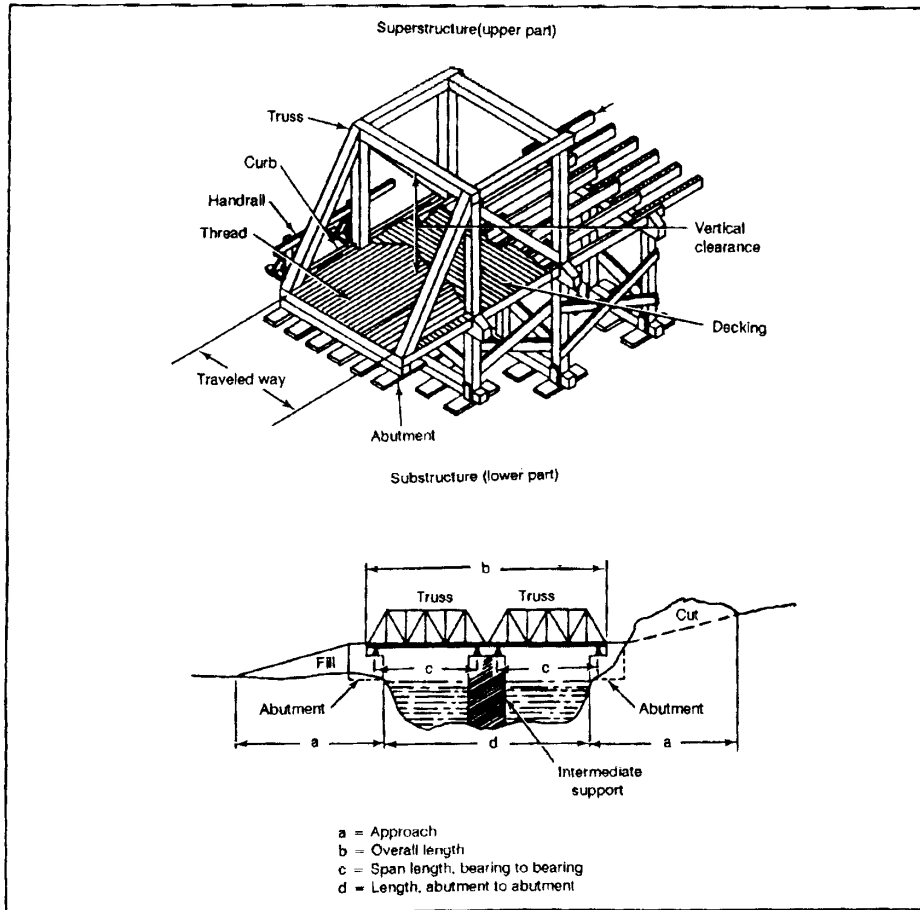


Figure 2-5. Bridge mensuration requirements

construction materials, manpower and equipment, and characteristics of the site. See Figure 2-5.

Based on their superstructures, bridges may be either fixed or movable. The five major categories of fixed bridges are beam, slab, girder, truss, and arch bridges. These types may occur alone or in combination. Movable bridges have at least one span that can be moved from its normal position to allow passage of vessels. The four general types of movable bridges are swing, lift, bascule, and retractile.

The load capacity is the most critical factor of a bridge. The most reliable capacity data comes from the standard design loadings by which most countries design their bridges. Usually a country has a number of standard design loadings for different capacity classes. Standard design loadings may be expressed by a letter, number, or symbol.

Bridge Reporting

The data base includes all on route bridges that can be identified and measured on aerial photography or derived from updated collateral sources. Structures less than 6 meters long are culverts; all others are treated as bridges. This cut-off length is flexible according to the prevalence of bridging in the study area.

All bridges present a potential restriction to traffic, and all items reflected in the collection checklist are important. Some of the basic requirements for information on any type of bridge are--

- Location, or kilometer stations from origin of section. The nearest kilometer should be given unless close spacing requires use of the nearest 0.1 kilometer for separate identifications.
- Obstacle crossed. Analysts must list the name of the stream when they know it. Other possible entries include gorge, railroad, and canal.
- Universal transverse mercator (UTM) coordinates to six places and geographic coordinates to the nearest second.
- Overall length, to the nearest meter. This should generally be the sum of the span lengths, but it should not include approaches.
- Roadway width to the nearest 0.1 meters of that portion of the deck over which vehicles normally run, excluding sidewalks, curves, parapets, truss superstructure, and so forth. Width is measured between the inside faces of the curbs.
- Horizontal clearance, or the limiting width to the nearest 0.1 meter at a point 30 centimeters above the edge of the roadway. This normally includes widths of curbs and sidewalks but excludes parapets and trusses. The horizontal clearance on a truss bridge is measured from a point 4 feet above the roadway.
- Vertical clearance, or the minimum distance between the roadway and any obstruction immediately over the roadway, to the nearest 0.1 meter. The letter *u*, for unlimited clearance, indicates no obstruction.
- Military load classification (MLC). This number indicates the carrying capacity of the bridge, including classifications for single- and double-flow traffic. The symbol to show the MLC is a circle with the bridge information on the inside. The load classification is on the top of the circle. In those instances where dual classifications for wheeled and tracked

- vehicles exist, both classifications are shown. See TM 5-312 for further information. See the NATO bridge symbol on Figure 2-6.
- Spans. Both the number and length of spans need to be determined. Lengths are given to the nearest 0.1 meter and represent the distance between supports, or centers of bearing. The bridge classification is measured from center to center of supports and is based on the weakest span.
 - Span construction. The construction material and type will be identified.
 - Bypasses. Bypasses are local detours along a specified route that enable traffic to avoid an obstruction. They are classified as easy, difficult, or impossible according to the ease of access to the bridge bypass. See Figure 2-6.

Culverts

Culverts are grouped into four main categories of pipe, box, arch, and rail girder spans. Pipe culverts are the most common. They are usually concrete, but corrugated metal and cast iron are also used. The pipes have different shapes and range from 12 inches to several feet in diameter. Box culverts are used to a great extent in modern construction. They are rectangular in cross section and usually concrete. A large box culvert is similar to a slab bridge. Arch culverts were used frequently in the past but are rarely constructed now. They are concrete, masonry, brick, or timber. Rail girder spans are found on lightly built railways or, in an emergency, on any line. The rails are laid side by side and keyed head to base and may be used for spans of 3 meters or less.

Tunnels, Galleries, and Snowsheds

Features on a transportation route where it would be relatively easy to block traffic or that affect the traffic capacity of the road are critical. Such features include

BRIDGE RECONNAISSANCE REPORT								DATE	SIGNATURE					
For use of this form, see FM 5-33; the reporting agency is TRADOC.								23 MAR 90	[Signature]					
TO: (Headquarters ordering reconnaissance)				FROM: (Name, grade, and unit of officer or NCO making reconnaissance)										
CDR EUGEN AHN GZ				GARY C. SEEBUM, 1LT 18 th ENGR										
NAWS (Country, state and sheet number or name)				DATE/TIME GROUP (of signature)										
BELGIUM 150,000 LIEGE				23 MAR 1440Z										
SERIAL NO	LOCATION	CLEARANCE			SPANS			LENGTH AND CONDITION	ADDITIONAL BRIDGE INFORMATION (Add columns as needed)					
		HORIZONTAL	UNDER BRIDGES	NUMBER	TYPE OF CONSTRUCTION	CONCRETE	STEEL		MILITARY LOAD CLASSIFICATION	OVERALL LENGTH	TRENCHES WIDTH	CRESTHEAD CLEARANCE	BY-PASS POTENTIAL	REMARKS
1	JA 308167	52	160	2	a	18.2w	35	146	52	∞				
2	JA 335414	∞	220	6	4	aK 9.2w	30	60	40	∞			IMPASSIBLE	
3	JA 325218	60	41	1	1	a 33w	80	33	6.2	4.8			EASY	

DA FORM 1249 PREVIOUS EDITION OF THIS FORM IS OBSOLETE.

Figure 2-6. Bridge Reconnaissance Report

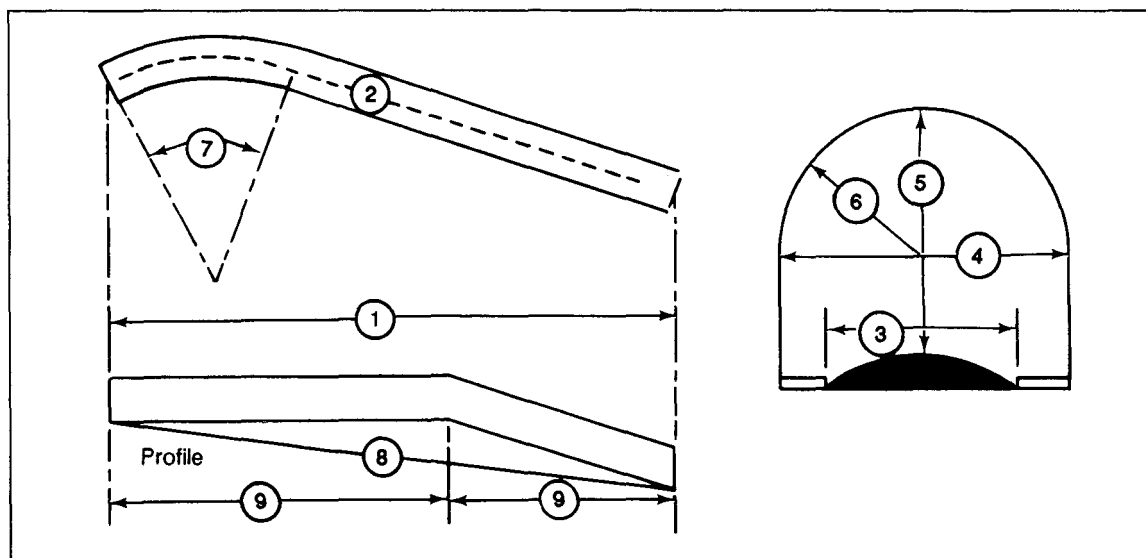


Figure 2-7. Dimensions required for tunnels

tunnels, snowsheds, and galleries. These obstructions can prevent access to vehicles with certain physical dimensions. Reductions in traveled-way widths, such as narrow streets in built-up areas, drainage ditches, and embankments, can also limit vehicular movement. This is an important aspect of transportation intelligence.

Tunnels

A tunnel is an underground section of the route that has been bored or made by cut-and-cover for a route passage. It consists of the bore or bores, portals, and possibly a liner. Tunnel bores are commonly semicircular, elliptical, horseshoe, or square with arched ceiling. Bores may be lined with brick, masonry, or concrete, or they may be unlined. Some very long tunnels on steam-operated railroad lines are artificially ventilated by blowers at the portals or in ventilating shafts above the bore. Alignment of tunnels may be straight or curved. See Figure 2-7.

Galleries and Snowsheds

Built in rugged, mountainous terrain, these protective structures are not as common as bridges or tunnels. Galleries offer protection against snow and rock avalanches. They may be cut into the side of a cliff and have a natural overhang, or the cover may be a concrete slab, either of which guides the avalanche across the track or road. One side of a gallery is usually open. Snowsheds offer protection against snow accumulations and slides on exposed sections of the permanent way.

Ferries

Ferries or ferry boats convey traffic and cargo across a river to another water barrier. These vessels vary widely in physical appearance and capacity depending on the depth, width, and current of the stream and on the characteristics of traffic to be moved. Propulsion of ferries may be by oars, cable and pulleys, poles, or stream current such as trail and flying ferries, or by steam, gasoline, or diesel

LEGEND

1. Portal-to-portal length of tunnel
- 2.. Center line distance of tunnel
3. Effective width of the traveled way, curb to curb
4. Horizontal clearance (minimum width of the tunnel bore measured at least four feet above the traveled way)
5. Overhead clearance (minimum distance between the top of the traveled way and the lower edge of the tunnel ceiling or any obstruction below the ceiling such as trolley wires or electric light wires)
6. Rise of tunnel arch (radius of curved portion)
7. Radius of curvature of the traveled way either measured or estimated
8. Gradient (percentage of rise of the traveled way between portals)
9. Change in gradient within the tunnel (percentage of rise each way from break of grade)

engines. Construction of ferry boats varies widely from expedient rafts to ocean-going vessels.

The capacity of a ferry boat is usually expressed in tons and total number of passengers and is sometimes assigned an MLC number. When more than one ferry is employed for a given site, report the capacity of each.

Climatic conditions have a marked effect on ferry conditions. Fog and ice substantially reduce the total traffic-moving capacity and increase the hazard of the water route. Therefore, data on tide fluctuations, freezing periods, floods, excessive dry spells, and their effects on ferry operations is important.

A ferry site is the place where ferries convey traffic and cargo. Ferry slips or piers are generally provided on the shore to permit easy loading. The slips may vary from simple log piers to elaborate terminal buildings. A common characteristic of ferry slips is a floating or adjustable approach ramp that accommodates variations in ferry deck level. Analysts must consider the limiting characteristics of ferry sites, such as the width of the water barrier from bank to bank, the distance and time traveled by the ferry boat from one side to the other, and the water depth at each ferry slip.

Approach routes to ferry sites have an important bearing on ferry use. Analysts should report the condition of the approaches, including the load-bearing capacity of landing facilities.

Fords

A ford is a location in a water barrier where the current, bottom, and approaches permit the passage of personnel or vehicles and other equipment, where little or no swimming is required, where they cross under their own or assisted propulsion, and where their wheels or tracks remain in contact with the bottom.

Fords are classified according to their crossing potential, or trafficability, for foot or wheeled and tracked vehicles. Fordable depths for vehicular traffic can be increased by suitable waterproofing or, in the case of modern tanks, by adding deep-water fording kits that permit fording depths up to 4.3 meters.

Approaches may be paved with concrete or bituminous surface material but are usually unimproved. Analysts should carefully note the composition and slope of approaches to a ford to permit determination of trafficability during inclement weather and after fording vehicles have saturated surface material.

Bottom conditions are determined by checking the stability and composition of the bed. The composition of the stream bottom determines its trafficability. In some cases, the natural river bottom of a ford may have been improved to increase load-bearing capacity and to reduce the water depth. Improved fords may have gravel or concrete surfacing, layers of sandbags, metal screening or matting, or timber or wooden planking.

Climatic conditions such as seasonal floods, excessive dry seasons, freezing, and other extremes of weather materially affect stream fordability. The velocity of the current and the presence of debris also affect the condition and passability of a ford.

Current estimates are swift (more than 1.5 meters per second), moderate (1 to 1.5 meters per second), and slow (less than 1 meter per second).

Low-water Bridges

Low-water bridges consist of two or more intermediate supports with concrete decking and are located wholly within ravines or gullies. **During** high-water periods, they may easily be confused with paved fords, as both are completely submerged. **Because** of corresponding military load limitations, analysts must properly identify low-water bridges and paved fords.

Cableways and Tramways

Cableways, tramways, and so forth are not usually major factors in a military operation; however, they may be encountered in rugged mountainous regions and beach areas or used as connections between two primary supply routes. In some cases they may extend for several miles and be the best available method for moving supplies.

Pipelines

Pipelines that carry petroleum and natural gas represent an important mode of transportation. While rail, water, and road transport are used extensively for transporting fluids and gases, the overland movement of petroleum and refined products is performed most economically and expeditiously by pipeline. Crude-oil pipelines are used only to transport crude oil, while many refined-product pipelines carry more than one product. These products are sent through the pipelines in tenders, or batches, to keep the amount of mixing to a minimum. Because of their most vital link in an industrialized country's energy supply system, coal and ore are also carried in pipelines as slurry.

Components

Pipes are used in long-distance pipelines and in many local lines. They are composed of welded steel with diameters varying from 15 centimeters to more than 1 meter, depending upon the economies of the line's construction. The pipe may be laid either underground or above ground **and** may extend cross-country or follow the alignment of roads and railroads. When a pipeline must cross a stream, the pipes are usually laid along the stream bottom. Where streams are **swift** or where beds may shift rapidly, either the pipe is attached to existing bridges or **special** pipeline suspension bridges are built. Siphon crossings are used where necessary,

When an increase or decrease of pressure is required, regulating features such as pumps or compressors are used. Pumping stations are used for liquid fuels and compressor stations for gas. They are similar in appearance except for the cooling towers present at compressor stations.

Valves, manifolds, and meters are integral parts of any pipeline system and are located at frequent intervals along the pipeline and at terminals. Valves protruding from the ground are often the only indicators of a pipeline alignment.

Terminal Facilities

Refinery terminals consist of numerous tanks for the separate storage of crude oil and refined products. Facility size and type depends on whether the refinery is located near the source of supply or consuming center. Refined-product dispensing terminals contain a variety of products for final distribution.

Natural gas is generally stored in bulk, below the ground, and under high-pressure. Large underground gas storage pools, usually caves or quarries near consuming centers, are often used to store gas for seasonal or emergency needs. Above ground, natural gas is stored mostly under pressure in spherical tanks, but large telescoping tanks are sometimes used for low-pressure storage. Natural-gas receiving terminals are located at the producing field and contain facilities for conditioning the gas for pipeline transmission. Natural-gas dispensing terminals are located at

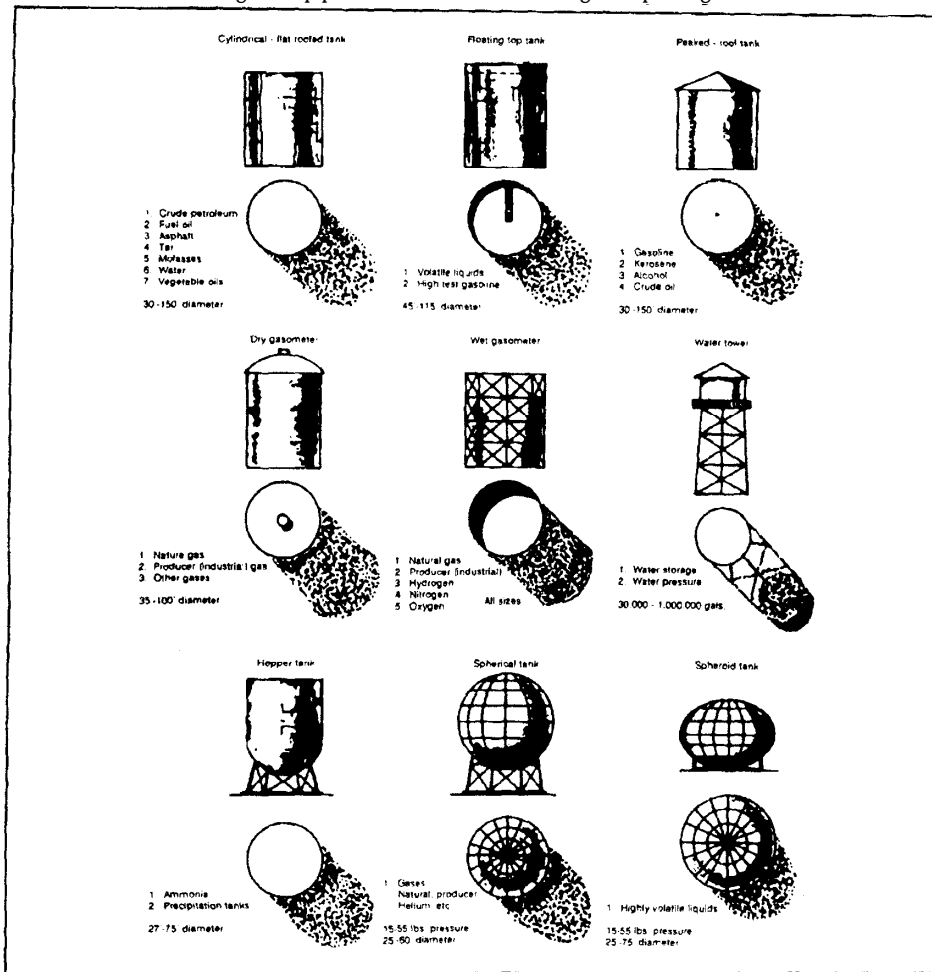


Figure 2-8. Storage tanks - Shapes

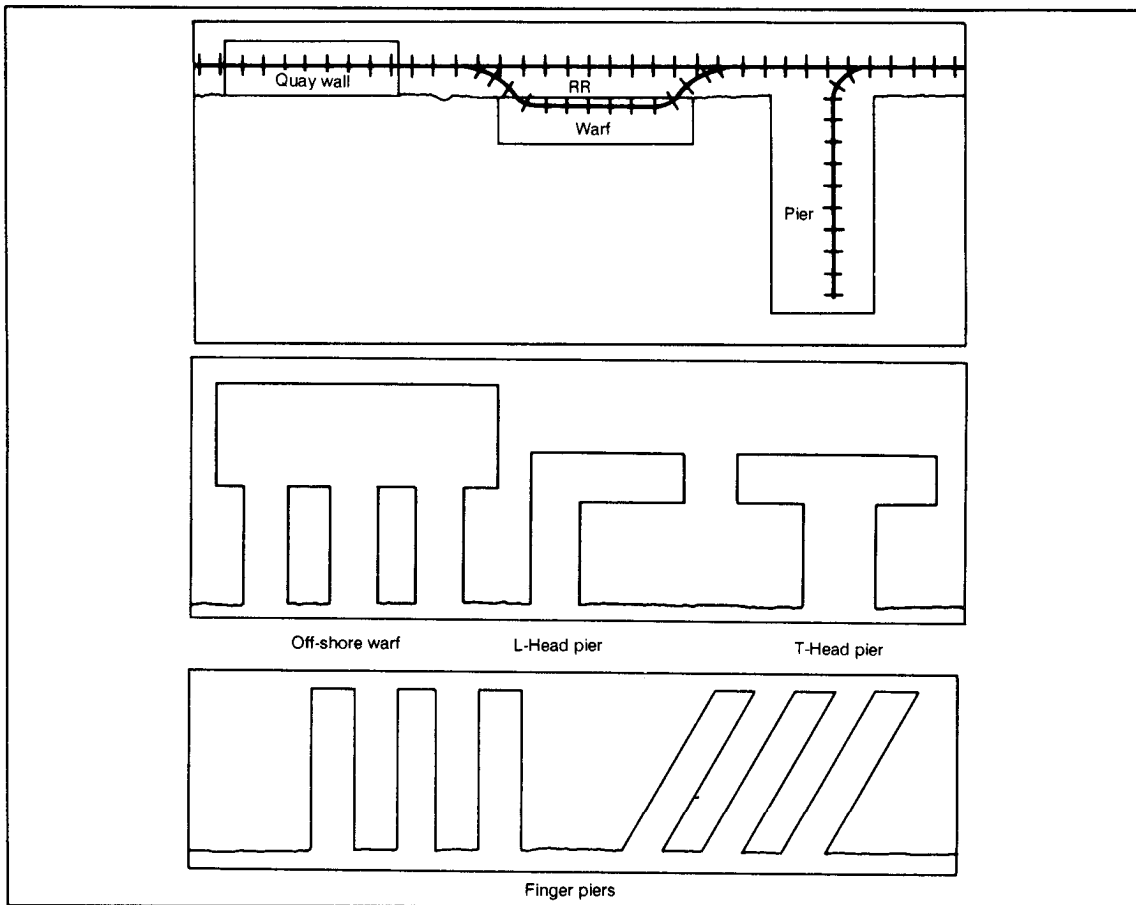


Figure 2-9. Berthing facilities

consuming centers and include dispatching and metering facilities and sufficient storage facilities to meet peak demands.

Storage tanks, found in varying numbers at all petroleum installations, are easily recognized. Volatile products such as gasoline and kerosene are generally stored in floating roof tanks. These tanks have roofs that float on the liquid to reduce space in which vapor might form. Nonvolatile products such as fuel oils and crude oil are stored in fixed-roof tanks. Petroleum gases are generally liquefied and stored under pressure in spherical tanks or in horizontal cylindrical tanks. The number and variety of tanks in a storage installation indicate the quantity and types of product stored. Areas of great extent and capacity are called tank farms. See Figure 2-8.

PORTS AND HARBORS

Information about ports, naval bases, and shipyard facilities is essential for estimating capacities, vulnerability, and other items of military significance.

Ports

Ports are settlements with installations for handling waterborne shipping. Principal port facilities are berthing space, storage space, cargo-handling equipment, cargo transshipment facilities, and vessel-servicing facilities. Ports are classified on an areawide rather than a worldwide basis, and a principal port in a small

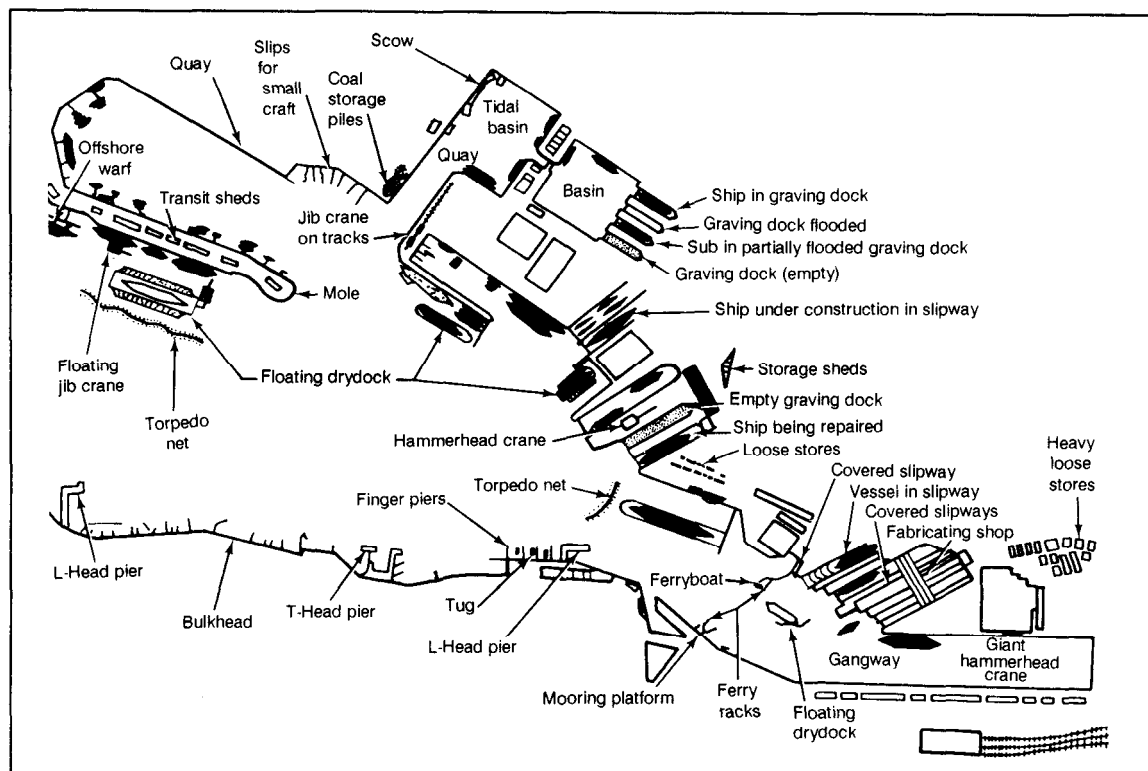


Figure 2-10. Annotated overlay of a European harbor (Kiel, Germany)

maritime nation may be equivalent to a much lesser port in the more extensive port system of another country. In wartime, principal and secondary ports and bases are prime targets for destruction, and the relative importance of minor ports increases. See Figure 2-9.

Ports may have various structures affording berthing space or may be anyplace a vessel may be made fast. These structures include piers, moles, and wharves or quays. Perhaps the most important difference between these structures is that piers are supported by pilings driven into the harbor bottom, while moles are of solid construction. In addition, wharves and quays are parallel with the shoreline, while piers and moles are perpendicular to it.

Harbors

Harbors are areas where the anchorage and shore are protected from the sea and storms by natural or man-made barriers. Areas that do not have this protection but are still suitable for vessel anchorage are open anchorages or roadsteads. A good harbor must have deep water, adequate protection from storms, enough space to accommodate large numbers of vessels, and a shoreline that can be developed as a port and as a site for industry. Harbors may be situated on the sea, estuaries, or inland lakes and rivers and may easily be recognized by abundant waterborne traffic and port facilities. See Figure 2-10.

Relatively few strategically located natural harbors are large enough or safe enough to be valuable to shipping. Many of the important harbors of the world are man-made. Most harbors have some or all of the more common artificial protective

structures. A breakwater is a massive stone or masonry structure extending across or at an angle to the entrance to the harbor. A jetty is the name applied to a breakwater that connects with the shore. A mole is a jetty that is wide enough to allow construction of a roadway along the top. A sea wall is a structure built along the coastline to prevent the sea from eroding the land.

Within the harbor itself are various types of buoys used as navigational aids. In addition, lighthouses, mooring buoys, and dolphins are often present. Mooring buoys are huge buoys located in the harbor so that vessels may tie up without dropping anchor. Only when a harbor has been developed for transacting business between ship and shore does it become part of a port. Dolphins are groups of pilings driven into the harbor bottom for the same purpose.

Dolphins usually consist of a cluster of piles lashed together at the top. They are located off shore and are used singly for mooring into or hauling out of a berth and in a series for mooring a ship alongside. Dolphin moorings conserve space in the stream and are used either for idle berthing or for loading cargo from lighters. Dolphins are often associated with a wharf either as a protective device at wharf corners or as a means of increasing the length of berthing space provided by a wharf face.

A dock, also called a slip or berth, is the water adjacent to a mole, pier, or wharf when that water area is narrow and affords berthing space. Basins are broad and expansive, artificially enclosed bodies of water that form a harbor or part of a harbor. They may be tidal basins in which water is subject to tidal influences, or controlled-level basins in which the water level is maintained irrespective of tidal change. Controlled-level basins are either wet docks or half-tide basins. A wet dock is enclosed by a gate, caisson, or lock. It may be filled by naturally impounding water at each high tide or at spring tides only. Pumping plants may be provided for initial filling or for elevations of the water above that achieved by natural impounding. The half-tide basin has gates at each end and is used in much the same manner as a large leek to increase the enormous amount of water required to raise the water level. It cannot be used at all states of the tide.

Harbor works, including protective works, are structures designed to provide shelter, control water flow, and regulate erosion for improvement of the navigability of a harbor. The principal structures are breakwaters, jetties, groins, sea walls, bulkheads, dikes, locks, and moles. Harbor works do not include port facilities that are designed specifically for transfer of cargo and the servicing ships.

Depths are important in such port topics as harbor, entrance, anchorage, wharves, and dry docks. They are computed in terms of established reference planes that are based on but do not necessarily coincide with tidal levels. The particular reference plane on which depths on a hydrographic chart are based is called chart data and is defined on the chart. Precise data is established for most ports and is a basis for soundings. Analysts should clearly indicate the reference plane when reporting depths.

The navigable waterways through the approach, the entrance to the harbor, and the harbor itself frequently determine the size of the ships (draft, length, beam, height above water) that can be accommodated in the port. Analysts should describe in detail any thruway with controlling dimensions that limit the size of

ships which can traverse it. Reports on the experiences of ships with critical dimensions that have entered are most helpful.

Cranes (Cargo-handling Equipment)

Cargo berthing space may be recognized by the presence of heavy handling equipment located on piers or wharves. However, very small ports may not have any such equipment, requiring vessels to supply and use their own. Port cargo-handling equipment includes various hoists for handling general cargo and special equipment for other cargo.

A gantry crane is a traveling crane on rails that consists of a hoist on a heavy cross girder supported at two points. Hoisting is performed by a trolley or crab that moves transversely along the bridge. Gantry cranes occasionally serve as a base for a jib crane, the latter being mounted on and capable of transverse movement along the bridge member. They are used extensively in shipyards for hull erection and in various industrial yards and shops for heavy lifting. They are almost always electrically operated. Depending on use, they may range up to 250 tons capacity. Hoisting capacity is constant regardless of the position of the crab or trolley on the bridge.

A cantilever crane consists of a base or tower structure on which is mounted a counterbalanced horizontal arm or jib. A trolley that can be racked along rails on the cantilevered jib carries the hoisting sheaves. The trolley does not carry the hoisting mechanism but merely serves to support the fall, and its transverse movement is controlled by a system of sheaves and ropes. Cantilever cranes are most commonly found in shipyards, although they may be used for cargo handling in special instances where a large working radius is required. They are normally electrically powered and range up to 250 tons or more in capacity. Capacities should be reported at maximum and minimum radius. One type of cantilever crane is the hammerhead. These cranes are supported at one point, about which the mechanism can turn. The hoisting end is balanced by a cab or counterweight. The entire machine may be mounted on rails for movement along the pier or wharf.

A jib crane consists of the primary arm on which is mounted a shorter arm, or jib, extending at an angle. At the end of the jib are sheaves through which run the fall from which the load is suspended. The fall is raised and lowered by a hoisting mechanism built into the crane. Jib cranes are frequently mounted on gantry, bridge, or trestle bases, where they are capable of transverse movement. Because of their versatility, they are the most common cranes and have a wide range of uses. They include wharf cranes for handling general cargo and many cranes used in shipyards. They are usually electrically powered and range in capacity from 3 to 5 tons. Other jib cranes may range up to 100 tons or more. Analysts customarily report the capacity at minimum working radius and at maximum radius. They must also indicate the maximum height of lift above the wharf deck for wharf cranes.

A floating crane is almost any crane mounted on pontoons or barges. The float may range from a simple wooden barge to an elaborately constructed steel hull with built-in balancing tanks and pumps. Large floating cranes, usually steam powered, are commonly used in harbor construction, salvage operations, or transfer of heavy cargo to and from ships. Capacity may exceed 400 tons. Small floating cranes, driven by internal combustion engines or operated manually, are used for many lifting tasks. The operating dimensions are reported similarly to those for shore

cranes, except that reach beyond the pontoon is substituted for radius. Dimensions of the pontoon include length, beam, draft forward, and draft aft.

A derrick consists of a vertical mast supporting a pivoting jib or boom. The mast may be stayed by cable or beams anchored to the ground, with the fall running through sheaves at the end of the jib. Large derricks are used for miscellaneous heavy-lifting tasks and run on steam, gasoline, diesel, or electricity. Small derricks are used for simple cargo handling and are operated manually or are driven by gasoline or diesel engines. Derricks and shearlegs are normally the simplest and least expensive cranes. Depending on size and type, capacity may range from 1 to 40 tons. The jib of a derrick functions similarly to that of a jib crane, and operating dimension should be reported the same way.

A shear-leg crane is a fixed hoisting device with a leaning tripod supporting the system of pulleys and cables. Heavy shear legs may range up to 150 tons capacity. In hoisting and lifting motions, the operating dimensions are comparable to those of the jib crane.

A locomotive crane may be recognized easily, because it is mounted on a special railroad flat car. A revolving elevated crane is mounted on a high, derrick-like structure that moves along rails. An overhead crane differs from a gantry crane in that the supporting mechanisms do not move as they do on the gantry. A bridge crane is constructed so that the crane may travel beyond each supporting leg.

Anchorage

Much of the anchorage data can best be shown on large-scale charts and plans. All available operational information should be reported, including anchorage designations and berth assignments by local authorities, normal anchoring practices, and ship experiences.

Fixed moorings may consist of anchored buoys or mooring posts. They are provided in harbors where space restrictions prohibit free-swinging anchorage, where the number of accommodations is limited, and when they provide a more secure berth than a ship's own anchors can provide.

Mooring buoys can provide several berth types, including free-swinging (one buoy), ship's head secured to buoy; bow and stem (one buoy), ship secured ahead by own anchors and astern to bollards ashore; bow and stem (two buoy), ship secured to buoys ahead and astern. Buoys may be held by a single anchor, but two or more anchors laid at varying angles are generally used for greater holding capacity and more precise positioning of the buoy. When more than one anchor is used, each may connect independently with the buoy secured by a pendant chain. Mooring buoys, particularly those used by naval craft, may be fitted with submarine cable connections for telephone, electricity, and water. The holding capacity of the buoy is important information.

Ships may lie in fixed moorings without buoys in a variety of ways. The simplest method, that of mooring with one or both anchors ahead and stem lines to bollards ashore, is used where wharf facilities are limited, and is commonly used in Mediterranean ports.

Harbors are usually subject to sea and swell, and navigation and port operations are consequently affected. Duration and seasonal variation in sea and swell conditions are important factors to analysts, as are specific effects on lighterage and boat work on anchoring and mooring and on movement into and about the harbor.

Wharves

The majority of landing structures are either piers or wharves. Piers project into the water at an angle with the shoreline. Berthage is usually available on both sides of the pier and at the head as well, if the structure is wide enough. Variations of the simple straight pier are the T-head pier and the L-head pier. These piers are commonly used to transfer bulk petroleum, and berthage is generally confined to the pier head.

Wharves form the pivot point for port operations, and detailed information concerning them is necessary to evaluate a port's capabilities. Generally, wharves include all landing structures, even piers. Specifically, a wharf is a structure that parallels the shoreline and provides berthage at its face only. A wharf's design is determined largely by its intended use and by local conditions and engineering practice. Variations in names of landing structures cause considerable confusion, and analysts should be careful to use the proper term. The term *dock* is properly used in northwestern European countries to designate a water area; in the US, however, it is applied generally but erroneously to any and all types of landing structures. The pier structure is commonly called a jetty in British and other foreign ports, and all marginal structures are *quays*. Improper classification will often be embodied in the proper name of a wharf, but the reporting officer should not arbitrarily change the name. In describing the structure, however, the analyst should correctly indicate the wharf type.

The wharf type may be marginal, quay, or offshore. The marginal wharf and quay are both built parallel to and against the shore and differ only in construction type. The marginal wharf is constructed of open piling, while the quay is a solid wall of masonry or other material. The offshore wharf is a structure of open piling built parallel to but in an insular position off the shoreline. It may be connected with the shore by one or more approaches or gangways or pipelines. A variation of the offshore wharf commonly used in the Far East is the pontoon wharf, which consists of pontoons of various construction moored in a fixed position offshore and connected with the shore by one or more adjustable gangways. This type is used where the water level fluctuates considerably.

Two special wharf types are the mooring platform and the breasting platform. The mooring platform is a small offshore wharf with a square platform or deck. It provides berthage for a ship but is too small for cargo transfer. Mooring platforms commonly are provided in groups of two or more, and ships are berthed across the faces. One or more of a group of mooring platforms are generally connected with the shore by a narrow approach or trestle, and platforms may be connected by catwalks. The breasting platform is a small platform structure projecting from the face of the wharf bulkhead. Breasting platforms are usually provided in groups of two or more, and ships are berthed across the heads. See Figure 2-11.

An offshore pipeline berth is connected to the shore solely by a submarine or floating pipeline, which permits cargo transfer directly to storage installations on shore.

In a terminal buoy system, the terminal buoy looks similar to the standard mooring buoy but is substantially larger. It is positioned offshore in deep water with three or more chains attached to heavy anchors. The terminal buoy has a revolving platform or swivel to which the tanker is secured as are the floating hose lines for cargo, bunker oil, and fresh water. When the buoy's flexible hoses are coupled to the ship's system, this permits ship and hose lines to swing together a full 360 degrees with the wind or sea. Product transfer proceeds through submarine pipelines connecting the buoy and ashore installation.

Wharf construction and materials vary greatly; however, most structures are either open or solid construction. Open construction is used for marginal wharves, offshore wharves, and most piers. In its simplest and least permanent form, it consists of open-spaced wooden piling supporting a wooden deck. Variations designed to contribute to the strength and permanence of the open structures are

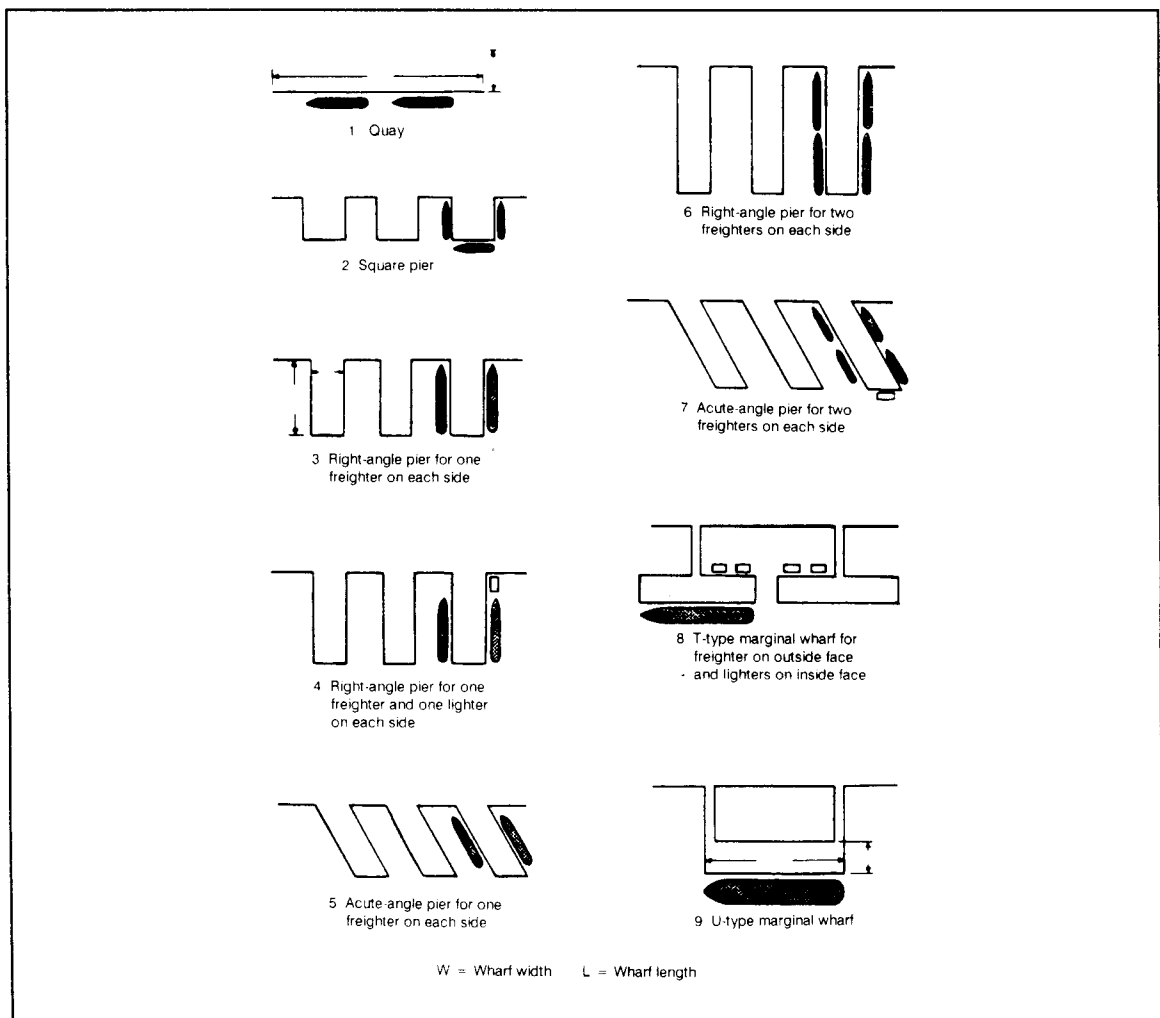


Figure 2-11. Types of wharf layout

numerous. Substructures may consist of steel or precast concrete piling. The superstructure or decking may vary from wooden joists and flooring to concrete and steel construction with an asphalt or other paved surface.

Solid construction is used in quays (and occasionally in piers) and consists of a solid backfill against a retaining wall and covered with a surfaced decking. Quay walls may be a simple facing of interlocking sheet steel piling, a monolithic concrete wall, or a masonry structure built of stone or precast concrete blocks. Many quays abroad consist of large concrete caissons sunk in line to form a wall, then filled with concrete or rubble and capped with a reinforced concrete deck.

Wharves require several basic dimensions; careful measurement and precise identification of reference points is essential. Measurement may be in either feet or meters, since conversion tables are available.

The length of one side of a pier may differ from that of the other, and both should be reported. The side of a pier or the face of a wharf may be irregular or stepped, and a dimension should be reported for each segment. Usable berthing space may or may not coincide with the overall length; shoals or other obstructions may decrease the usable length of a wharf.

The width of a marginal wharf may be difficult to determine, since the inner limit may not be defined. In such cases, the measurement points should be clearly identified. Width of apron is not to be confused with width of wharf. The apron is the working part of the wharf deck at shipside; it terminates at the transit shed or other obstruction.

The type and condition of the deck surface has an important bearing on the usability of a wharf. Analysts should indicate the layout of wharf railroad tracks with respect to the wharf deck. They should be particularly careful when reporting berthing capabilities of a wharf. Special or unusual berthing conditions include the breasting of ships off the wharf by means of pontoon, the presence of surge or swell that might require special mooring precautions, and draft limitations.

Harbor Craft

The operation of most ports requires a fleet of various harbor crafts. Although in large ports the composition of the fleet may undergo frequent changes, information about types, general numbers, and operating characteristics of harbor craft is essential.

Tugs are generally seagoing or harbor. Analysts should list the horsepower, power type, operating range of seagoing salvage tugs, and special equipment such as salvage or fire-fighting equipment. When no tugs are present, launches are important. They may be grouped by horsepower and power type.

Lighters may be broken down by size and type (self-propelled and dumb); in large ports their numbers may be given in round figures. Information requirements include such details as capacity, construction, power type, and specialized lighters for handling ammunition.

Harbor-dredging operations use dredges, hopper barges, and rock breakers. Dredges vary in type and mechanism, depending on the nature of the bottom

sediments to be worked. Hopper barges are self-propelled or dumb barges fitted with self-emptying hoppers. They haul material recovered by dredges. Rock breakers, as the name implies, are used in special cases when loosening of rock from the harbor floor is required.

Shipyards

Complete up-to-date information is required on shipyard facilities and on all firms capable of making marine repairs but lacking dry-dock facilities. Valuable information is contained in maps, yard plans, individual facility plans, shop layouts, photographs of yard facilities, and docking manuals. Each shipyard should be positively identified by position within a city or port, with references to outstanding landmarks on waterfront, rivers, and tributaries.

The principal types of dry-dock facilities are the graving dock, floating dry dock, and marine railway. The three gate types provided for graving docks are leaf gates, flap gates, and sliding caissons. Leaf gates are hinged swinging gates that fold back into recesses in the walls of the entrance when the dock is open. Flap gates are hinged at the bottom and lowered outward to a horizontal position in the approach to the dock. The sliding caisson rolls or slides on a track on the dock sill.

Ship construction and conversion are not treated in detail in port studies dealing with terrain intelligence; however, information about the physical facilities used in construction and repair are valuable to the intelligence analyst. This information includes the types of structural, engineering, electrical, and miscellaneous shops in which various shipbuilding and ship repair processes are performed; the types of ships constructed and the largest of each type constructed to date; whether repairs can be made without dry docking by means of caisson; the yard's reputation for speed in accomplishing repair work; and the general capabilities of the yard as to hull, engineering, and electrical repairs.

Naval Bases

Natural features required of a good naval-base site include a harbor with deep-water approaches; protected and spacious deep-water anchorages; positions capable of being easily defended; sufficient land for expansion; elevation of approximately 1.5 to 3 meters above mean high water at the waterfront; suitable ground for the foundation of dry docks, buildings, and heavy equipment; and an ample supply of safe, freshwater. Local labor, materials, and transportation must be adequate to support the operation. Secondary stations of the shore establishment are necessary to fleet operation.

Although they will vary in both size and relative importance, certain functional components are common to given types of naval bases. Submarine bases will almost always contain a torpedo shop, battery repair shop, electrical battery-charging equipment, and high-pressure air-charging equipment. Medical components of a large activity may contain, in addition to the normal medical and dental equipment, specialized equipment and resuscitating gear for divers. Analysts should indicate whether or not a particular component is included among the base installations.

Landings

Landings may be structures that are usable for landing, although primarily designed to serve some other function, or they may be beaches in the harbor on

which landings are possible. Landings assume particular importance when a port becomes unusable by damaged or sunken vessels and when they must serve as the supplemental or principal medium of transfer between ship and shore. These structures include breakwaters, sea walls, bulkheads, seaplane ramps, and beaching hardstands. In wall-type structures, the length, depth alongside as referred to chart data, height of the top above chart data, and batter of face wall are significant. For all structures, analysts should identify the construction type, condition of the sea and current alongside, and clearance facilities.

Airfields

Air facilities are the military and civilian installations upon which a nation's air operations depend. The fundamental air facilities are airfields, seaplane stations, and heliports. Each has its own facilities such as runways, hangars, fuel systems, maintenance ships, and crash, fire, and service equipment. At some small foreign airfields, many functions may be combined in one or two centrally located buildings.

A. Airfields:			
No.	Feature	Symbol	Specifications
1.	Runways		Outline runways to scale.
2.	Taxiways		Outline taxiways connecting runways, aprons, and hardstands to scale.
3.	Aprons		Outline aprons to scale.
4.	Hardstands		Outline hardstands to scale.
5.	Airfield perimeter		Draw a boundary line representing the airfield perimeter.
6.	Structures		Outline all structures. Number each and list in the Data Table.
7.	Airfield name-elevation	Columbus - 200m	Place name and elevation just outside the perimeter symbol.
8.	Runway azimuth		Place the runway azimuth at the end of the runway outline (within or just outside).
9.	Runway length and width		Place length and width designations inside, or just outside runway outline.
10.	Approach lighting		Show locations along line drawn to scale (length).
11.	Runways lights		Show locations by dot symbols along the lateral boundary of the runway.

Figure 2-12. Symbol specifications for airfields and heliports


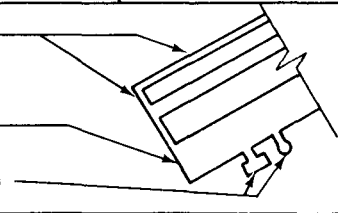

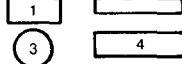

B. Heliports:			
No.	Feature	Symbol	Specifications
1.	Landing area - runways		Draw outline of the landing area or runway to scale.
2.	Taxiways		Outline taxiways connecting runways/landing areas, aprons, and hardstands to scale.
3.	Aprons		Outline aprons to scale.
4.	Hardstands		Outline hardstands to scale.
5.	Heliport perimeter		Draw a boundary line representing the heliport perimeter.
6.	Structures		Outline all structures. Number each, and list in Data Table.
7.	Heliport name/(No.) elevation	Columbus - 200m H-1	Place name (No.) and elevation just outside the perimeter symbol.
8.	Helipad (without facilities)		Circle .4" dia Letter .3" high

Figure 2-12 continued. Symbol specifications for airfields and heliports

The most advantageous location for an airfield is an area free from natural and cultural impediments to operations. An elevated rather than low area is preferred because of the absence of terrain obstructions and generally more favorable local weather conditions. Low areas are frequently exposed to adverse wind conditions, fog, and occasional flooding. Another important factor in airfield location is its intended use. Major civil airfields will almost always be located near the cities they serve. Major military installations, which normally require more land because of their vast complex of fixed facilities, are more often constructed some distance away from large cities. See Figure 2-12.

Auxiliary airfields are normally located near major operational or training bases. Often these facilities are on caretaker status during part of the year when their additional capacity is not needed.

A helipad is an area specifically designated and marked for helicopter landings and takeoffs. The surface of the pad may be natural, temporary, or permanent. A helistop refers to a helipad with little or no facilities and is used for on- and off-loading of cargo or passengers.

An airfield runway is a flat landing surface with a true or magnetic heading, normally taking advantage of prevailing winds. The number of runways or runs may vary from one to several, which are usually oriented in different directions. Some airfields have parallel runways (two runways with the same headings - not to be confused with a parallel taxiway). Runways are the most significant features of an airfield, and detailed information concerning them, taxiways, and parking areas is essential to properly evaluate the airfield's capabilities. The length, width,

load-bearing capabilities, and pavement condition directly influence the type and amount of traffic an airfield can accommodate.

Taxiways are access paths to parking aprons, hangar aprons, and handstands or revetments. A parallel taxiway parallels the runway but is usually narrower. Under emergency conditions it may be used as a runway, but it should not be reported as a runway. Link taxiways connect the runways with other taxiways, parking and hangar aprons, or revetments. A perimeter taxiway usually starts at one end of the runway and ends at the other, and is normally oval. Loop taxiways are normally located at or on both ends of the runway, forming a loop. The alert taxiway is located at the end of the runway with clear access to the runway for a scramble by fighter interceptors.

Runways, taxiways, aprons, and revetment surfaces may be permanent, temporary, or natural. Permanent surfaces such as concrete or asphalt have distinct edges and ends, while temporary surfaces such as mixed-in-place madam or oiled earth have ragged and uneven edges and ends. Permanently surfaced runways are easily discernible and may have jet barriers or arrester gear. Jet barriers are located on the overrun, whereas the arrester gear is normally flush with the runway and located approximately 500 meters from the end of the runway. This 500 meters is usable runway and should not be confused with an overrun.

Measuring permanent or temporary surfaced runways should not be difficult. The major difficulties are locating and arriving at the measurements of natural surface marked with painted barrels, reeks, or broken white lines. Runway lengths and surfaces vary according to the use or intended use of the airfield.

The weight- or load-bearing capacity of a runway, taxiway, or apron is a determining factor in its capability to accept aircraft without damage to the aircraft or the facility. The engineering factors involved in determining weight-bearing capacity are complicated; however, other sources for this information are route manuals, air information publications, airfield managers, and engineering documents. If these sources are not available, information about the type and weight of aircraft (partially or fully loaded) operating out of a given airfield will enable the analyst to estimate the weight-bearing capacity of the runway.



Natural Terrain

Chapter 3

SURFACE-CONFIGURATION OVERLAY

The surface-configuration overlay is used to depict the inclined surface of the terrain and is expressed using percent of slope or change of elevation (rise) divided by the horizontal distance (run).

This overlay is one of the primary overlays used in determining the cross-country movement capability of troops and vehicles.

A 1:50,000 topographic map is required to construct a surface-configuration overlay using TTADB product specifications.

Step 1. Examine topographic maps. Construct a surface-configuration overlay for the TTADB using a standard 1:50,000 topographic map with a variety of possible contour intervals. A contour interval of 20 feet or less is preferred for constructing this overlay.

Register the overlay to the database or map you are using. Cover the selected topographic map with a clean sheet of mylar and tape them together. If the area of interest does not cover the entire map, outline the area of interest on the mylar in black pencil or ink and note the longitude and latitude or UTM coordinates at the corners.

Annotate the map sheet name and number, map series, map edition, scale, contour interval, factor overlay type (surface configuration) and classification, if required, on the overlay.

Step 2. Depict surface-drainage features. Trace the boundaries, in black pencil or ink, of all islands longer and wider than 250 meters (5 millimeters at the scale of 1:50,000). Show long, narrow islands (those less than 250 meters wide) only if they are greater than or equal to 1000 meters in length (20 millimeters on the map).

Trace the boundaries of all open-water bodies such as ponds, lakes, reservoirs, and double-lined streams in black pencil or ink. Label all open water with a **W**.

Step 3. Depict dissected terrain. Trace the boundaries of all naturally and/or culturally dissected land areas in black pencil or ink and label with a **G**. Dissected terrain includes, but is not limited to, pits, quarries, dumps, landfills, piles, ravines, and gorges. Many of these features are easily recognized on topographic maps.

Step 4. Outline and label slope categories. Select a slope calculator (See Figure 3-1.) that was constructed for the scale and contour interval of the map used A slope calculator, also called a template or wedge, is an instrument for measuring the percent of slope on a topographic map. This instrument is constructed of a transparent, stable-base material and is marked with predetermined distances that correspond to the desired slope category. Ensure the slope calculator has the required slope categories established within the TTADB product specifications. If a suitable slope calculator is not available, you must construct one for the map you are using.

Example: Construct a slope calculator for slope categories of 0-3 percent and 3-10 percent, given a 1:50,000 topographic map with a contour interval of 20 meters.

a. Determine the horizontal distance required, with an elevation difference (contour interval) of 20 meters to equal the largest slope percent of a given category.

$$HD = \frac{CI \times (100)}{\% \text{ slope}}$$

HD = horizontal distance

CI = contour interval

% slope = largest slope percent of a given category

(100) = constant

Formula: Slope category A (0 to 3%)

$$HD = \frac{20 \times (100)}{3}$$

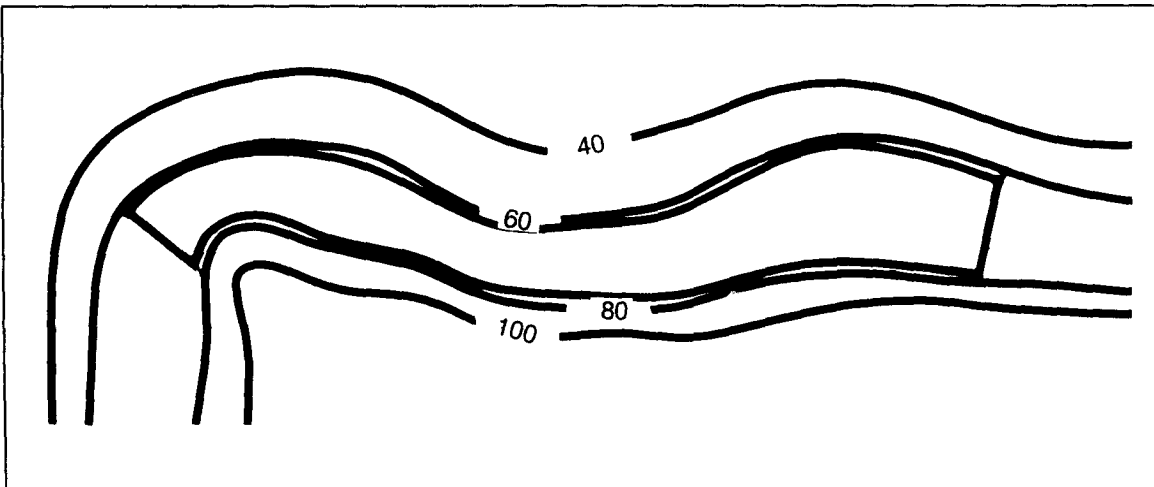


Figure 3-1.

Hd = 666.6 meters (CI was in meters)

Formula: Slope category B (3 to 10%)

$$HD = \frac{20}{10} \times (100)$$

HD = 200 meters

b. Determine the map distance, or the spacing of the contour intervals, required to construct the slope calculator for categories **A** and **B**:

$$MD = \frac{HD}{D}$$

MD = map distance

HD = horizontal distance (from previous formula)

D = denominator of map scale

Slope Category A (0-3%)

$$MD = \frac{666.6}{50,000}$$

MD = .01333 meters or (13.33 mm)

Slope Category B (3-10%)

$$MD = \frac{200}{50,000}$$

MD = .004 meters or (4 mm)

Note: You must calculate map distances for each slope category outlined in TTADB product specification (PS/3JB/020) and for any slope category required for a special-purpose product.

c. Construct the slope calculator. Construct the slope calculator using the map distance calculated from the above formulas on a clear, stable-based material. Draw several ticks representing the same slope category.

d. Outline the slope categories. Analyze the contour lines on a topographic map using the slope calculator to outline and label slope categories. Slope categories are areas on a map where the slope is the same or is in the same category.

Start the slope analysis in the upper left-hand corner of the map and determine map areas whose slope (contour interval) matches the 0 to 3 percent (or lowest category required) slope category on the calculator (See Figure 3-2). When you have outlined all areas within this category using a black pencil or ink, label all outlined areas with an A or representative symbol from your legend.

Continue this analysis for all slope categories that you have outlined and labeled. Prepare the surface-configuration legend according to TTADB product specifications.

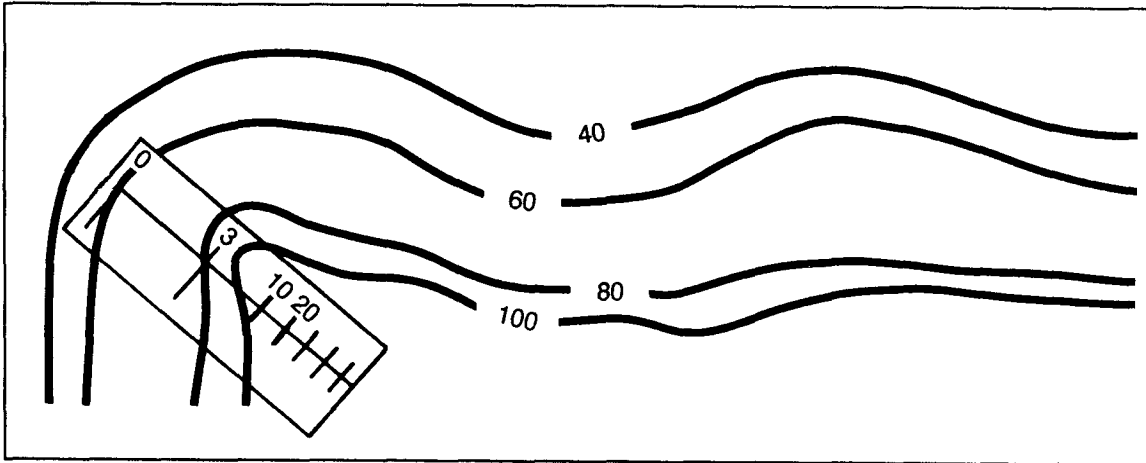


Figure 3-2. Slope example

Step 5. Determine slope from aerial photography. Determining slope from aerial photography requires complete stereo coverage. It is time-consuming and requires more skill than using a topographic map. You should use this method only if topographic maps are not available or if you need precise slope measurements from a point to a point. You cannot use this process to compile a surface-configuration factor overlay, since this overlay is keyed to a topographic base map.

Step 6. Construct the final overlay. The final step in producing a factor overlay is to put the draft manuscript overlay into a final database product. You must have support from the cartographic and reproduction elements or sections. See Chapter 8 for the final overlay procedure.

VEGETATION OVERLAY

The vegetation overlay shows natural and cultivated vegetated areas, with information about type, size, and density. This factor overlay is one of the primary overlays used in determining the cross-country movement capability of troops and equipment, cover and concealment line of sight, and location of construction resources.

A 1:50,000 topographic map and complete stereo imagery is required to construct a vegetation factor overlay using TTADB product specifications.

Step 1. Collect required collateral data. The vegetation factor overlay is one of the most complex and difficult factor overlays terrain analysts construct. No single source data can provide all of the data required to complete the vegetation factor overlay and data tables. In most cases, analysts must use different sources for different geographic areas. Unlike other factor overlays, where terrain factors are similar worldwide, geographical location, climate, soils, and the agricultural practices of the location being analyzed greatly influence the vegetation factors. Some of the major sources are maps, literature, and aerial imagery.

Military topographic maps. Standard military topographic maps differ in completeness according to scale and country of origin. The boundaries of forested areas

are generally accurate on topographic maps but size, type, and density information cannot be obtained from the map alone. See Figure 3-3.

Small-scale vegetation maps. This product can be found in any general geography text and usually depicts very broad categories of vegetation. It does not give enough of the detailed information required but will give analysts background on agricultural practices and the predominant vegetation types of the area.

Data Element	United States		Federal Republic Germany		USSR	
	1:250,000	1:50,000	1:250,000	1:50,000	1:200,000	1:50,000
1. Map unit identification/ Veg boundaries	Limited to major veg boundaries	Limited to major veg boundaries	Limited to major veg boundaries	Limited to major veg boundaries	Limited to major veg boundaries	Limited to major veg boundaries
2. Mean height to top of canopy	Woodland > 3 m, Scrub < 3 m	Woodland > 3 m, Scrub < 3 m	No	No	Yes	Yes
3. Percent canopy closure by season	Limited est for major veg type	Limited est for major veg type	Limited	Limited	Limited	Limited
4. Number of stems per hectare	No	No	No	No	No	No
5. Crown diameter	No	No	No	No	No	No
6. Mean stem diameter	No	No	No	No	Yes	Yes
7. Number of trees in each stem diameter class per hectare	No	No	No	No	No	No
8. Stem spacing	No	No	No	No	Yes	Yes
9. Species identification, seasonality, and distribution	No No No	No No No	Coniferous Deciduous Mixed only	Coniferous Deciduous Mixed only	Coniferous Deciduous Mixed only	Coniferous Deciduous Mixed only
10. Ground cover type, percent of cover, and height	No	No	No	No	No	No
11. Litter type and depth	No	No	Limited	Limited	Limited	Limited
12. Mean height to lowest branches	No	No	No	No	Limited	Limited
13. A representative transect	No	No	No	No	No	No

Figure 3-3. Map capabilities for vegetation data elements

Species distribution maps. These maps are produced under a variety of names depending on their geographical location and the type of data they present. They are produced primarily for use as forestry tools by government agencies, commercial lumber companies, and colleges and universities. They provide extremely detailed information but are produced for limited areas and specific functions. If they are not available, the analyst should query local government agencies and universities located in the area of interest. This is only feasible if the area of interest is accessible to the terrain analyst and if local agencies are friendly and willing to assist.

Literature. Literature is nearly unlimited in quantity, scope of subject matter, and coverage of geographic regions. Data from this source is usually too general to be of much use but can be used to verify other data.

Aerial imagery. Analysis of aerial imagery is the best and most accurate method of obtaining detailed vegetation information. The quality of information obtained depends largely on the skill and knowledge of the individual analyst and the type and quality of the imagery available.

Step 2. Determine data elements. After identifying and collecting sources of information, analysts must determine the data elements or essential elements of

terrain information (EETI) required to produce the vegetation factor overlay. The data elements required are--

- Vegetation-area boundaries.
- Vegetation type.
- Height to top of canopy.
- Canopy closure.
- Stems per hectare.
- Stem diameter.
- Stem spacing.
- Ground cover.
- Height to lowest branches.
- Seasonal information.

Step 3. Prepare collateral data. Gather all available data that covers the area of interest. Examine the information to ensure completeness and accuracy, to see if some of the information is old or dated, and to see if newer sources are available. Vegetation can be influenced by man's activities and can change in a relatively short period of time.

Identify information gaps. After all available information has been gathered, superimpose it on the base map to determine areas where information does not exist or is too old to be reliable.

Submit collection requirement. If information gaps exist, determine alternate available sources and submit the appropriate collection requirement. The collection request can be for new imagery or for on-site verification of dated information.

Step 4. Prepare topographic map base. Construct the vegetation overlay for the TTADB using a standard 1:50,000 topographic map. Register the overlay to the data base or map you are using. Cover the selected topographic map with a clean sheet of mylar and tape them together. If the area of interest does not cover the entire map, outline the area of interest on the mylar in black pencil or ink and note the longitude and latitude or UTM coordinates at the corners. Annotate the map sheet name and number, map series, map edition, state, factor overlay type (vegetation) and classification, if required, on the overlay.

Prepare the data table worksheets. Trace the boundaries, in black pencil or ink, of all open-water bodies such as ponds, lakes and double-lined streams and label them with a **W**.

Trace the boundaries of all built-up areas that are longer and wider than 250 meters (5 millimeters at 1:50,000 scale). Label the outlined areas with an **X**.

Step 5. Determine vegetation types and boundaries. Trace the boundaries of all forested areas. For the working overlay, label all forested areas with a **T**. Further analysis will determine type, size, density, and internal boundaries or changes.

Trace the boundaries of all agricultural areas and label the areas with an **A**. Determine the type of crops, such as dry, wet, terraced or rotating/shifting crops and add the second agricultural code (see Figure 3-4.). The analysis of collateral data will be required to determine the second code.

Trace the boundaries of all brushlands and label them with a **B1** or **B2**, depending on the vegetation category. The analysis of collateral data will be required to determine the second code.

<u>MAP UNIT CODE</u>	<u>TYPE</u>
A1	Agriculture (dry crops)
A2	Agriculture (wet crops, rice)
A3	Agriculture (terraced crops, both wet & dry)
A4	Agriculture (shifting cultivation)
B1	Brushland (< 5m high, open to medium spacing)
B2	Brushland (< 5m high, medium to dense spacing)
C*	Coniferous/Evergreen Forest
D*	Deciduous Forest
E*	Mixed Forest (Coniferous/Deciduous)
F*	Orchard/Plantation (rubber, palm, fruit, etc.)
G1	Grassland, Pasture, Meadow
G2	Grassland with Scattered Trees, some Scrub Growth
H	Forest Clearing (cutover areas, burns, etc.)
J**	Swamp (mangrove, cypress, etc.)
J	Marsh/Bog (treeless bogs, muskegs, etc.)
K	Wetlands (L.S.I., low-lying wet areas)
L	Vineyards/Hops
M	Bamboo
N	Bare Ground
W	Open Water
X	Built-up Area

*These vegetation types are given a three digit map unit code. In addition to the letter for the type code, a second digit (number) is added as the canopy closure code, and a third digit (number) is added as the height code. See Canopy Closure (%), Height (meters), and example below.

** A second digit, representing canopy closure, is added to the swamp code.

Figure 3-4. Vegetation map codes

Trace the boundaries of all grasslands and label them with a **G1** or **G2**, depending on the vegetation category. The analysis of collateral data will be required to determine the second code.

Trace the boundaries of all swamps (**I**), marshes and bogs (**J**), and wetlands (**K**) and label them accordingly.

Step 6. Determine forest type and boundaries. Since different types of trees have different characteristics and have a major impact on cross-country mobility, on cover and concealment, and on use as engineering resources, you must determine the forest type and the transition boundary of the areas already labeled **T**.

Trace the boundary of all coniferous/evergreen forests and label them with a **C**. This forest category must contain 60 percent or more species of coniferous trees. These trees are relatively easy to place within a broad classification because they tend to have definite sizes and shapes. Shadows, crown shape (see Figures 3-5 and 3-6) and photographic tone are the most common photo interpretation keys.

Trace the boundaries of all deciduous forests and label them with a **D**. This forest category must contain 60 percent or more species of deciduous trees.

Trace the boundaries of all mixed forests and label them with an **E**. Mixed forests are those forests that do not contain 60 percent or more of either coniferous or deciduous trees.

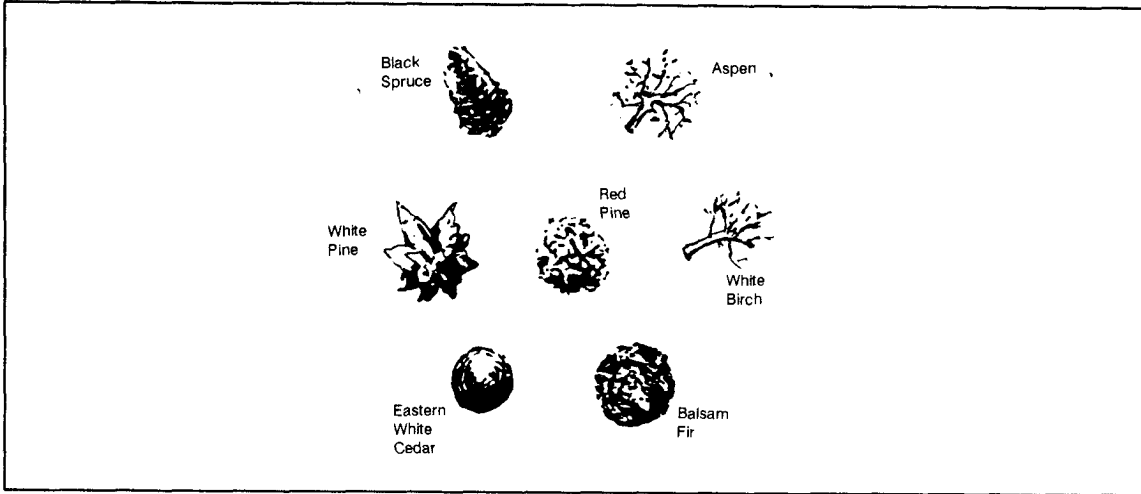


Figure 3-5. Vertical views of tree crowns

Trace the boundaries of all orchards and/or plantations and label them with a **F**. This category can be identified by the uniform rows and photographic tone and texture. Analysis of the collateral data will key analysts to look for this vegetation type and location.

Step 7. Determine canopy closure. Canopy closure is the percent of ground area covered by the tree crown and is normally computed only for forested areas. Crown area is the area covered by the vertical projection of a tree crown to the horizontal plane.

Vegetation types indicated by **C**, **D**, **E** and **F** are given two digits in addition to the letter. The letter denotes the tree type, the first number represents the canopy closure, and the second number is the height. For swamps (**I**), the third digit or height code is omitted.

Canopy closure is coded in four categories:

CODE	CANOPY CLOSURE %
1	0 - 25
2	25 - 50
3	50 - 75
4	75 - 100

Use the crown density scale to determine the canopy closure. It is made of columns of squares containing solid black circles. These circles cover and represent a percent of the area (see Figure 3-7 within the square). Match the appropriate scale to the forested area on the imagery and record the crown density for a given area.



White pine



Red pine



White spruce



Jack pine



Black spruce



Eastern hemlock



Tamarack



Balsam fir



Eastern white Cedar



White birch (old)



White birch (young)



Aspen



Basswood



Sugar maple



Red maple



Silver maple



Yellow birch



Beech



Oak



Balsam poplar



Ash



Elm

Figure 3-6. Silhouettes of forest trees.

Compare only the tree crown and not the shadows visible on the photo. Factors affecting accuracy of canopy closure measurements include--

Note: When tree shadows fall on level ground, they often permit identification of individual species.

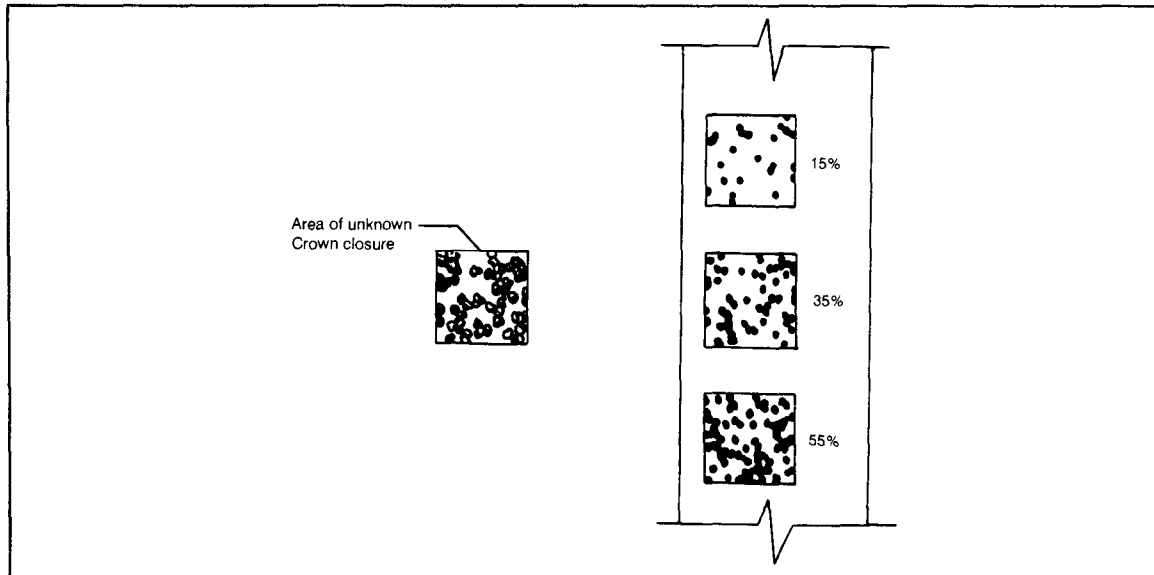


Figure 3-7. Sample crown density scale

- Image quality. Crown closure estimates of forest stands on poor quality photographs tend to be too high because of the lack of detail in photo tones and the inability of the analyst to identify small crown openings.
- Shadows. Shadows tend to mask stand openings causing the stand to appear more dense.
- Photographic scale. The minimum canopy opening that can be identified on photography is directly related to the photographic scale. Small openings which can be identified on 1:6000 scale photography cannot be seen on 1:20,000 scale photography. The net effect is to overestimate canopy closure when using small-scale photography.
- Analyst skill. An average analyst using good quality photography should produce crown closure estimates accurately to within 10 percent.

Step 8. Determine the mean height to top of canopy. The second number, or third digit, depicts the tree height (see Figure 3-8). Mean height to top of canopy is the mean or average height of a specific tree type or category. If existing data to determine and outline mean tree height does not exist, use aerial photography to measure tree height (see Chapter 9). Three methods to measure tree height from aerial photography are the parallax, shadow, and relief displacement methods. Factors affecting the accuracy of height measurements include--

- Photographic scale. Tree height measurement error generally increases when small-scale photography is used due to the inability of the analyst to identify the tree's apex.
- Character of forest. Measurement of tree height is dependent on the analyst's ability to see the ground nearby. This is closely related to the stand density and ground clearance. If a forest stand is very dense, such as a tropical rain forest, it is very difficult to find an opening large enough to permit accurate measurements.

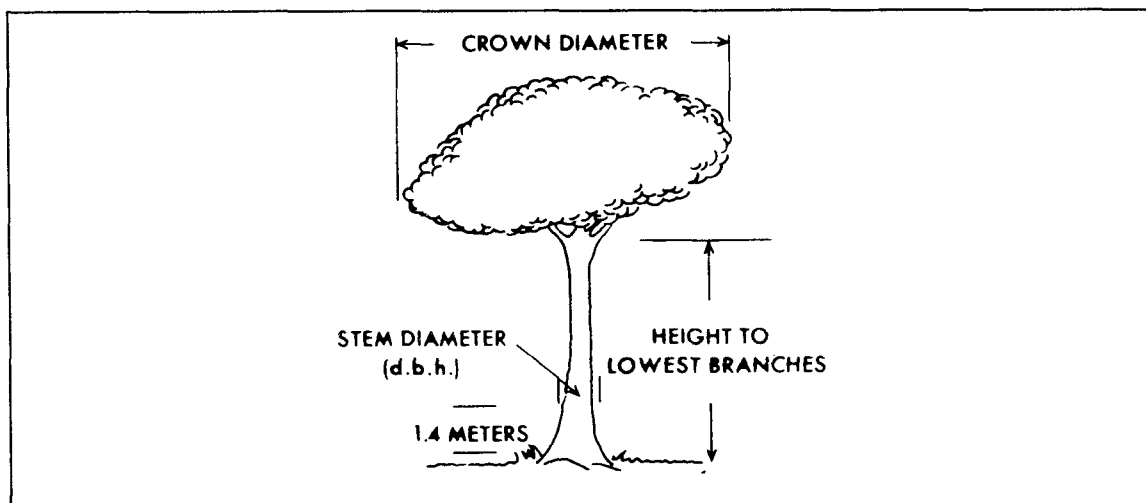


Figure 3-8. Tree mensuration

- Terrain relief. Trees growing in areas that are not level are difficult to measure accurately because of a tendency to refer measurements to canopy openings at elevations different than those at the base of the tree.
- Analyst skill. An analyst should be able to determine the height of trees accurately within each map unit. Knowledge of forest conditions and classification of specific tree type (species) can be an invaluable aid in height classification.

Step 9. Determine tree crown diameter. Tree crown diameter is the distance across the spread of a tree crown and is measured in meters. Diameter measurements of the largest, average, and smallest crowns in each category will determine the average crown diameter for a given map unit. This measurement is made using the dot-type scale or the crown micrometer wedge on the photograph (see Figure 3-9).

Select a tree for measurement. Slide the dot-type scale alongside the tree until you find a dot that is equal in size to the tree's crown. It is best not to fit the circle over the crown, because too much detail is screened by the black dot or circle.

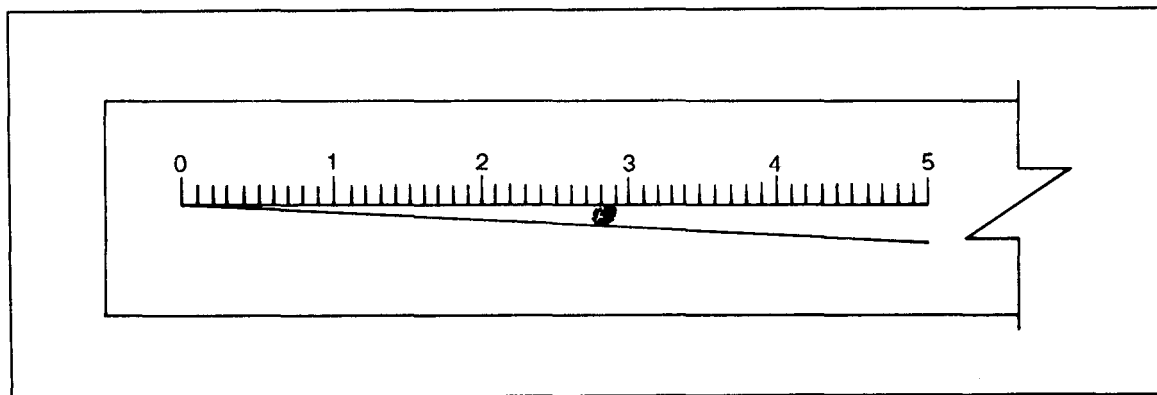


Figure 3-9. Crown micrometer wedge

Select a tree for measurement. Place the micrometer wedge so the insides of the two diverging lines are just tangent (making contact at a single point) to the tree. Take a reading at the point on the scale where the tree crown is tangent to the diverging lines.

Take an average of three measurements using either method. The answer will be in millimeters of photo distance. Convert the answer to ground distance by multiplying by the denominator of the photo scale. Convert millimeters of ground distance to meters by dividing by 1000. Factors affecting accuracy of crown diameter measurement include--

- Photographic scale. The analyst's ability to accurately identify the largest, average and smallest crowns is closely associated with the photographic scale. Small-diameter crowns cannot be detected on small-scale photographs, and clumps of closely spaced trees tend to be measured as a single crown rather than as several small ones.
- Location on the photograph. Limit tree crown measurements to the center portion of the photograph whenever possible, because the center is less affected by distortion.
- Forest density. Crown diameter measurements are most accurate in open-grown stands. Measurements in dense stands are usually limited to crown widths for dominant trees.

Step 10. Determine mean stem diameter. Tree stem diameter is the diameter of a tree at 1.4 meters (4.5 feet) above the ground. This measurement is also referred to as diameter at breast height (DBH). Calculate mean stem diameter for all vegetation units with trees 2 meters or greater in height. Record this information on the vegetation data table in centimeters.

Tree stem diameter is calculated using the mean crown diameter information obtained in step 9. If this step has not been completed, calculate the mean crown diameter for the vegetation within each map category.

When computing the stem diameter for coniferous trees, use the following formula:

$$\text{DBH (inches)} = \frac{\text{D (feet)}}{2} + 5$$

Where--

DBH (inches) = Diameter at breast height

D (feet) = Crown diameter

Example: In step 9, you have determined that a stand of coniferous trees has a mean crown diameter of 6.4 meters.

a. Convert mean crown diameter measurement to feet.

$$6.4 \text{ meters} \times 3.231 \text{ feet per meter} = 20.998 \text{ feet}$$

(Round to 21 feet)

- b. Use the above formula to determine DBH (inches).

$$\text{DBH} = \frac{21 \text{ feet}}{2} + 5 \quad \text{DBH} = 15.5 \text{ inches}$$

- c. Convert DBH (inches) to centimeters.

$$15.5 \text{ inches} \times 2.54 \text{ inches per cm} = 39.37 \text{ cm}$$

- d. Record the mean stem diameter in the vegetation table.

When computing the stem diameter for deciduous trees, use the following formula:

$$\text{DBH (inches)} = .75 \times D \text{ (feet)}$$

Example: In step 9, you have determined that a stand of deciduous trees has a mean crown diameter of 8.5 meters.

- a. Convert mean crown diameter measurement to feet.

$$8.5 \text{ meters} \times 3.281 \text{ feet per meter} = 27.885 \text{ feet}$$

(Round to 27.9 feet)

- b. Use the above formula to determine DBH (inches).

$$\text{DBH} = .75 \times 27.9$$

$$\text{DBH} = 20.925 \text{ inches}$$

- c. Convert DBH (inches) to centimeters.

$$20.925 \text{ inches} \times 2.54 \text{ inches per cm} = 53.1495 \text{ cm}$$

Round the answer to 53.15 cm.

- d. Record the mean stem diameter in the vegetation table (see Figure 3-10)

Step 11. Determine stem spacing. Stem spacing is the distance from the center of one tree to the center of the nearest adjacent tree. The easiest and fastest method to determine stem spacing is to measure directly from the photograph and convert it to ground distance (in meters).

Use the microcomparator to measure from the center of a tree stem to the center of the closest tree stem. This measurement unit depends on the scale used in the microcomparator, usually made in feet, and should be converted to meters.

If the scale is not acceptable and the distance is not measurable, use the following formula:

$$\text{SS (meters)} = \frac{12.372}{N}$$

CODE	FOREST TYPE AND CANOPY CLOSURE															
	C1	C2	C3	C4	D1	D2	D3	D4	E1	E2	E3	E4	F1	F2	F3	F4
1																
2																
3						5.0										
H E I G H T	4					1.8										
	5					.80										
	6															
	7															
	8															
	9															

Example D23 indicates the following: 5.0 cm — Average Stem Diameter
 1.8 m — Average Tree Spacing
 .80 — Vegetation Roughness

Figure 3-10. Vegetation table

Where--

- SS (meters) = Stem Spacing in meters
- 12,372 = Constant
- N = Number of trees per hectare

Before you can use this formula, you must determine N. To determine N, use the following formula:

$$N = \frac{TC \text{ (tree count in hectare scale)}}{0.08}$$

N = Number of trees per hectare
 TC = Tree count in hectare scale

Determine TC (tree count in hectare scale) of a specific vegetation map code. Orient the stereopair for viewing. Place the transparent 0.08 hectare scale (see Figure 3-11) over the area using the appropriate photographic scale and count the number of trees enclosed within the circle of the hectare scale.

Convert the number of trees in a 0.08 hectare to the number of trees per hectare.

Example: 32 trees were counted within the 0.08 hectare circle using the 0.08 hectare circle template.

- a. Use the above formula to determine N.






















PHOTO SCALE	.08 HECTARE CIRCLE	CIRCLE DIAMETER	
		INCHES	MILLIMETERS
1:5,000		.253	6.38
1:6,000		.211	5.32
1:7,000		.1805	4.56
1:8,000		.158	3.99
1:9,000		.140	3.55
1:10,000		.126	3.192
1:11,000		.115	2.90
1:12,000		.105	2.66
1:13,000		.092	2.46
1:14,000		.090	2.28
1:15,000		.084	2.13
1:16,000		.079	1.99
1:17,000		.074	1.88
1:18,000		.070	1.77
1:19,000		.067	1.68
1:20,000		.063	1.60
1:21,000		.060	1.52
1:22,000		.057	1.45
1:23,000		.055	1.39
1:24,000		.053	1.33
1:25,000		.051	1.28

Figure 3-11. Sample hectare scale

$$N = \frac{32}{0.08}$$

$$N = 400$$

b. Use the above formula to determine SS, N = 400

$$SS = \frac{12.372}{400}$$

$$SS = 5.56 \text{ meters}$$

<u>MAP UNIT CODE</u>	<u>ROUGHNESS FACTOR</u>
A1	.80
B2	.95
G1	.90
G2	.60
H	.50
I	.10
J	.10
W	0
X	(not evaluated)

Figure 3-12. Vegetation roughness factors

c. Round off to the nearest 0.1 meter and record this figure in the appropriate column of the vegetation data table. Factors affecting accuracy of stem spacing measurement include--

- Tree spacing. Count only those trees that are visible from above and are sufficiently large in their exposed portion to be resolved. This problem is especially acute in tropical areas having more than one canopy.
- Photographic scale. Trees with a crown diameter of less than 0.6 meters will not be resolved at 1:12,000 scale photography. This minimum-resolved diameter increases to 1.2 meters on photo of 1:16,000 scale or smaller.
- Tree crown diameter. Tree count accuracy increases with an increase in tree crown diameter.
- Crown canopy structure. Irregularities in crown canopy tend to increase accuracy due to relief among trees.
- Terrain. If the terrain viewed in the photograph is not level, alter the area represented by a given circle or adjust the crown count to obtain the true number of trees per hectare. Compute compensation for terrain relief for every 200-foot difference in elevation.
- Analyst's skill. Inexperienced analysts may undercount the actual number of tree crowns by as much as 50 percent. For this reason, you must be careful to recognize double trees, sprout clumps, or multiple groups of trees. You can usually accomplish this by recognizing abnormally large crowns or irregularly shaped groups of crowns.

Step 12. Estimate vegetation roughness factor (VRF). The vegetation roughness factor is an estimated numerical factor that reflects the degree of vehicular speed degradation due to travel through a particular vegetation type on horizontal ground. The factor decreases from 1.0 (no speed degradation) to 0.00 (vegetation roughness does not permit off-road mobility) (see Figure 3-12). For example, grassland with little slowdown effect would have a VRF of 1.0 to 0.9, but a virtually impassable swamp with dense ground vegetation, fallen branches and trees, and exposed stumps would have a VRF of .1. The factor designated to a vegetation category is subjective and designated by the analyst. The plant's density, stem diameter, branching characteristics, root emergence, and so forth are all considered.

Step 13. Prepare the vegetation legend. Prepare the vegetation factor overlay legend according to DMA product specifications.

Step 14. Construct the final overlay. The final step in producing a factor overlay is to put the draft manuscript overlay into a final data base product. Support from the cartographic and reproduction elements/sections is required. See Chapter 8 for the final overlay procedure.

SURFACE MATERIALS ANALYSIS (SOILS)

Military planners rely heavily on soil analysis because soils vary in their ability to bear weight and withstand vehicle passes, as well as in their ease of digging. The moisture content and type of soil will affect road construction, material location, and trafficability determination. The soil factor overlay breaks down the soil types, characteristics, and distribution. Soils of the same type and quality will have similar strength and characteristics regardless of geographic location. The primary factors influencing like soil strengths are environmental changes.

Describing and classifying soil normally requires extensive field sampling and the expertise of soil scientists. The terrain analyst must be able to produce acceptable soil factor overlays by extracting information from maps, other factor overlays, aerial photographs, lab reports, boring logs, and other literature. The reliability of the soil factor overlay produced will vary with the type and reliability of the information sources. Seldom will a single source provide all of the information required.

Step 1. Collect required collateral data. Collect and analyze as many of the following sources as possible for the area of interest: maps; factor overlays; special reports, such as laboratory soil analysis reports, soil field test reports, and boring logs and well logs; literature; and aerial photographs.

The desirable scale for all source maps is 1:50,000. If 1:50,000 scale maps are not available, other existing maps should be converted to this scale.

Soil maps are produced by various organizations for specific purposes. Engineering firms may produce soil maps to support any type of construction project. Government agencies may produce soil maps for agricultural purposes, land-use planning, or special studies. The classification systems used on soil maps will vary with the producing agency and the purpose of the map. The systems must be translated into the USCS, which is the system used by the military for producing soil factor overlays. See Figure 3-13.

This table may be used as a guide in classifying soils for which no engineering test data are available. The symbol > means "greater than", the symbol < means "less than", and the symbol ≤ means "less than or equal to".			
USDA Texture Class and Symbol	Unified Symbol	AASHO Symbol	Soil Properties Related to Classifications
Clay, silty clay C, sic	CH MH CL	A-7 A-7 A-7	High shrink-swell clays Mica, iron oxide, kaolinitic clays Low LL, Generally < 45 pct clay
Silty clay loam sicl	CL ML-CL CH MH	A-7 A-7 A-7 A-7	Low LL, Plastic (A-6 if clay < 30 pct) Low LL, Moderately plastic (A-6 if clay < 30 pct) High LL, High shrink-swell clays High LL, Mica, iron oxide, kaolinitic clays
Clay loam cl	CL ML-CL CH MH	A-6 or A-7 A-6 A-7 A-7	Low LL, Plastic Low LL, Moderately plastic High LL, High shrink-swell clays High LL, Mica, iron oxide, kaolinitic clays
Loam l	ML-CL CL ML	A-4 A-6 A-4	Moderately plastic (A-6 if clay > 21 pct) Plastic (A-4 if clay < 22 pct) Low plasticity (A-7 if clay > 21 pct)
Silt loam sil	ML-CL ML CL	A-4 A-4 A-6	Moderately plastic (A-6 if clay > 21 pct) Low plasticity (A-7 if clay > 21 pct) Plastic
Silt, si	ML	A-4	Low plasticity
Sandy clay sc	CL SC	A-7 A-7	Fines > 50 pct Fines ≤ 50 pct
Sandy clay loam scl	SC SC CL	A-6 A-2-6 A-6	Plastic Fines 36-50 pct Plastic Fines ≤ 35 pct Plastic Fines > 50 pct
Sandy loam sl	SM SC SM-SC	A-2-4 or A-4 A-2-4 A-2-4	Low plasticity Plastic Moderately plastic
Fine sandy loam fsl	SM ML ML-CL SM-SC	A-4 A-4 A-4 A-4	Nonplastic Fines ≤ 50 pct Nonplastic Fines > 50 pct Moderately plastic Fines > 50 pct Moderately plastic Fines ≤ 50 pct
Very fine sandy loam vfsl	ML-CL ML	A-4 A-4	Moderately plastic Low plasticity
Loamy sands ls, lfs lvfs	SM SM-SC SM ML	A-2-4 A-2-4 A-4 A-4	Nonplastic Fines ≤ 35 pct Moderately plastic Fines ≤ 35 pct Low plasticity Fines > 35 pct Little or no plasticity
Sand, fine sand s, fs	SP-SM SM SP	A-3 A-2-4 A-3	Fines approximately 5-10 pct Fines approximately > 10 pct Fines < 5 pct
Very fine sand vfs	SM ML	A-4 A-4	Low plasticity Little or no plasticity
Coarse sand cs	SP-GW SP-SM SM SM	A-1 A-1 A-1 A-2-4	Fines < 5 pct Fines 5-12 pct Fines 13-25 pct Fines > 25 pct
Gravel, G 50 pct passes No 200 50 pct of coarse passes No 4 sieve	GP-GW GM or GC GM or GC GM GC	A-1 A-1 A-2 A-4 A-6	Fines < 5 pct Fines 5-25 pct Fines 26-35 pct Fines > 35 pct Fines > 35 pct

Figure 3-13. General relationship of systems used for classifying soil samples

Some vegetation features symbolized on topographic maps can provide clues to soil characteristics. Contours and land-use patterns can help define landforms and identify soil types. See Figure 3-14.

Geological maps may or may not be useful form soil analysis. Those maps which show the surface profile to bedrock usually define the type and depth of soil, as well as the parent material or bedrock.

In some cases, vegetation (or change of vegetation) can be an indicator of a specific soil type, change of soil type, or change of soil depth.

Climatic maps provide annual variations in temperature and moisture conditions. Of particular interest is information concerning the state of ground; for example, wet, dry, moist or frozen. This information is important in determining the stability of a soil or changes of stability with seasonal changes.

Literature reports are published by academic institutions, government agencies, or private firms on soil-related subjects such as soil, topography, geology, and vegetation.

Analysis of air photographs is the best overall method for obtaining soil information for large and inaccessible areas.

Step 2. Determine data elements. Once you have identified and collected the sources of information, determine the data elements, or EETI, required to produce the soils factor overlay. The data elements required are--

- The soil profile, which is a description of the soil with depth, including identification of soil layers; depth ranges for each horizon layer in

Landform/Bedrock	Climate	Commonly Associated Soils	
		Horizon	USCS Symbol
Sandstone	unspecified	surface (A) parent material (C)	SM, SM-SC, ML, SP, SW SM, SM-SC, GM, SC, GC, ML
	humid	A	SM
		B	SM, GM
C		SM-GM	
Shale	unspecified	surface (A) parent material (C)	CH, CL, CL-CH ML, CL, MH, CH, CL-CH, SC CL-SC, GC
	semi arid or humid	A	CL, CH
		B	CL, SC, CL-SC
C		CL, SC	
Limestone	unspecified	surface (A) parent material (C)	ML-CL, ML, CL, GM CL, CH, MH, ML, CH-MH ML-CL

Derived from D.S. Way, Terrain Analysis: A Guide to Site Selection Using Aerial Photographic Interpretation, 2nd Ed., McGraw-Hill Book Co., N.Y. 1978 and modifications to Way made by A. Reimer, ETL-TAC, 1979 & O. Mintzer, Ohio State, 1979.

Figure 3-14. Landforms and commonly associated soils

Landform/Bedrock		Climate	Commonly Associated Soils	
			Horizon	USCS Symbol
Limestone (continued)		tropical	lower horizons (B & C)	CH, MH, GC, GM
		humid		A ML-CL
				B CH
Interbedded, sandstone shale, limestone				C CH
	Flat-lying	unspecified	unspecified	CL, ML, CH, MH, ML-CL SC, GM, SM,
	Tilted	unspecified	unspecified	ML, MH, ML-CL
Intrusive	Granitic rock*	unspecified	surface (A) subsurface (B)	SM, ML, SC, ML-CL SC, CH, CL, CL-CH
	Granite	humid		A SM, ML, CL B SC C SC, CL
Extrusive, Basaltic & Volcanic		humid		A ML, CL
		tropical or subtropical		B CH, MH C ML-MH, MH, CH
		arid		A ML-CL, ML, GM B CH, CL, MH, ML-CL, GC
Slate		unspecified	unspecified	GM, GC, GM-GC
		humid		A SM B SM, ML-CL C SM, GM
Schist		humid		A SM, SC B MH-CH C SM, ML-CL, ML
Gneiss		humid		A SM, SM-SC, ML-CL, ML B MH, CH, SC C SM, ML CL, MH-CH, ML-CL MH,CH
Glacial Tilt/Ground Moraine		humid/derived from soft sedimentary rock		A ML, CL, ML-CL, OL B CL, CH, CL-CH C CL, CH, ML Note: A much wider range of texture is possible as in North Central U.S.A.
		humid/derived from igneous-metamorphic rock (crystalline)		A SM, ML, SC B SM, ML C SM, ML, GM Note: A much wider range of texture is possible as in North Central U.S.A.
Glacial/Moraines		humid/derived from soft sedimentary rock		A CL, ML, CL-CH, CH, GM, GC B CL, CH, GC C CL, CH, GC
		humid/derived from igneous-metamorphic rock (crystalline)		A SM-SP B GW, GC-GP, SC-SP C SM-SC, SW, SP, GM, GC, SM, SC

Figure 3-14 continued. Landforms and commonly associated soils

Landform/Bedrock	Climate	Commonly Associated Soils		
		Horizon	USCS Symbol	
Drumlins	unspecified/ derived from soft sedimentary rock	surface or subsurface (A or B)	ML, ML-CL, GM, GC	
		C	CL, GM, GC	
	humid/derived from igneous- metamorphic rock (crystalline)	A B C	GM-GC, SM GM-GC, SM GM, SM-SC, ML	
Eskers	unspecified	unspecified	GM, GM-GC, GP, SP, GW, SW SW-SM	
Kames	unspecified	unspecified	GP, SP, GP-GM, GM, GM-GC SM-SC, SP-SM, SM	
Glacial Outwash	unspecified	unspecified	GW, SW, GP, SP, GM, SM CL, GM-GC	
Silt/Clay Lakebeds	unspecified	A	ML-CL, CH	
		B	CL-CH	
		C	CL-CH, ML-CL, MH-CH	
Sandy Lakebeds	unspecified	unspecified	SM, ML, ML-MH, ML-CL	
Sand Dunes	unstabllized	no horizons	SP	
	stabilized	surface (A) parent mat (C)	SM, SP SP	
Loess deposits	unspecified	unspecified	ML, ML-CL, CL	
			semi arid	A B C
			ML-CL ML-CL ML-CL	
Flood Plains	braided channels	unspecified	unspecified	GW, SP
	point bars	unspecified	unspecified	SW, SP, GW
	natural levees	unspecified	unspecified	SM, ML
	slack water	unspecified	unspecified	ML, CL, MH, CH, MH-CH
	swamps depressions	unspecified	unspecified	OL, OH, PT, ML, CL, CH
	terrace	unspecified	surface subsurface	ML SC, GW, GP
Deltas	Arc delta	unspecified	surface (A) subsurface (B)	ML, CL, MH, CH GP, SP, GM, GC, SM, SC, GM-GC
		humid	A B C	ML absent GM-GC
	Bird's-foot delta	unspecified	A B C	OH CH-OH CH
Alluvial fans	unspecified	unspecified	GP, SP, SW, GW, GM, GC SM, SC, ML, CL	
			semi arid	A B C

Figure 3-14 continued. Land forms and commonly associated soils

Landform/Bedrock	Climate	Commonly Associated Soils	
		Horizon	USCS Symbol
Valley fills	unspecified	unspecified	GP, SP, GW, SW, GM, GC SM, SC, CL, ML, CL-CH, CH
	semi arid	A B C	SM SM ML-SM, SM, GM, SM, ML
Continental alluvium	unspecified	unspecified	CL, SC, CL-CH, CH
	semi arid	A B C	CL CL CL
Playas	unspecified	unspecified	ML, CL, SM, SC, MH, CH
Swamps, Bogs & Marshes	unspecified	unspecified	PT, OH, CH, MH, OL
Coastal Plain Uplands	unspecified	subsurface (A) subsurface (B)	SM, SP-SM SM, SC, SP-SM
	humid	A B C	SM SC, SM SC, SM
Coastal Plain Depressions	unspecified	unspecified	OL, ML, CL, ML-CL, MH CH, OH, PT
Beach Ridges	unspecified	surface (A) subsurface (B)	SM, GM SP, GP, GP-GM, SP-SM, SW
	humid	A B C	SM Absent SP, SM
Tidal Marsh	unspecified	surface (A) subsurface (B)	PT OL, OH, MH
Mud Flat	unspecified	unspecified	CH, CH-MH, CH-OH
Sand Flat	unspecified	unspecified	SP

Figure 3-14 continued. Landforms and commonly associated soils

Note: *Granitic rock includes rhyolite porphyry, trachyte porphyry, dacite porphyry, basalt porphyry, augitite porphyry, granite, syenite porphyry, syenite, diorite porphyry, diorite, gabbro porphyry, gabbro, pyroxenite porphyry, pyroxentite periodotite

meters; and identification of soil type for each horizon with one of the 15 USCS symbols.

- Depth to bedrock, or the total thickness of soil in meters.
- State-of-ground, or the average monthly moisture condition of the soil.
- Stoniness, or the estimated number of stones of a given diameter per volume of soil, which may be expressed as a percentage of the volume.
- The rating cone index (RCI), an on-site or estimated value of soil strength derived from the cone index multiplied by the remolding index.
- The cone index (CI), the field measurement indicating the shearing resistance of soil, obtained with a cone penetrometer.

- The remolding index (RI), a ratio that expresses the proportion of original strength that will be retained by a fine-grained soil or a sand with fines, poorly drained, after being subjected to vehicular traffic.

Step 3. Prepare collateral data. Gather all available soil maps that cover the area of interest. Examine their scales and legends. Extract those at 1:50,000 scale or larger that use the USCS. If any of these maps are based on field surveys (field classification), they may be used as the soil factor overlay base. Further data analysis or extraction may be unnecessary if the soil maps can produce all the information required by the data elements.

Step 4. Prepare topographic map base. Extract the topographic maps that cover the area of interest. A scale of 1:50,000 with a contour interval of 20 feet or more is preferred.

Cover the selected topographic map with a clean sheet of mylar and tape them together. If the area of interest does not cover the entire map area, outline the area of interest on the mylar in black pencil or ink and note the longitude and latitude or UTM coordinates at the corners. Register the overlay to the data base or map you are using.

Annotate the map sheet name and number, map series, map edition, scale, factor overlay type (surface materials) and classification, if required, on the overlay.

Trace the boundaries of all open-water bodies such as lakes, ponds, and double-line streams in black pencil or ink, and label them with a W.

Trace the boundaries of all built-up areas that are longer than 250 meters (5 millimeters at 1:50,000 scale). Label the outlined areas with an X.

Trace the boundaries of all permanent snowfields in black pencil or ink, and label with a them PS.

Trace the boundaries of all areas of salt evaporators and salt encrustation in black pencil or ink, and label them with an EV.

Step 5. Determine soil types and boundaries. Evaluate collateral source material for soil boundaries and types. If data does not already exist, analyze landforms, vegetation, and geology information to determine USCS type and boundary.

Trace the boundaries of all areas of exposed bedrock or void of surface soils in black pencil or ink, and label them with an RK.

Evaluate the soil factors and place appropriate boundaries on the overlay in black pencil or ink, using the topographic map as a base.

Label all evaluated areas with the appropriate USCS symbol. If information conflicts exist between different source materials, use the most reliable and current information available. Assign to each different area (soil type) a map unit number, numbering from top to bottom and left to right. Areas with the same surface soil type and identical horizon information will have the same map unit number. Do not assign map unit numbers to RK, PS, EV, X and W areas. The third digit after the USCS symbol shows the surface roughness factor.

EXAMPLE

TRAFFICABILITY TEST DATA								
PROJECT LOCATION PDG 488519				TYPE OF VEHICLE M26A1, TRK, TRACTOR, 6x6				
CONE INDEX VALUES								
		DIAL READINGS AT DEPTH						
TEST NUMBERS	0"	6"	12"	18"	24"			
1	48	56	64	70				
2	42	50	58	64				
3	41	49	57	63				
4	46	54	62	68				
5	47	53	60	66				
AVERAGE	44.8	52.4	60.2	66.2				
CI ₁ = Normal Abnormal		49	56	63				
CI ₅₀ = 56								
CRITICAL LAYER FOR 1 VEHICLE 0-6"				CRITICAL LAYER FOR 50 VEHICLES 6-12"				
REMODELING INDEX VALUES								
DEPTH	LAYER 0-6"		LAYER 6-12"		LAYER		LAYER	
	BEFORE	AFTER	BEFORE	AFTER	BEFORE	AFTER	BEFORE	AFTER
0"	57	50	54	47				
1"	59	53	56	50				
2"	62	55	59	51				
3"	66	57	64	53				
4"	71	59	67	54				
AVERAGE	63.0	54.8	60.0	51.0				
RI = $\frac{A}{B}$	$\frac{54.8}{63.0} = .869$		$\frac{51.0}{60.0} = .850$					
REMODELING INDEX FOR 1 VEHICLE .87				REMODELING INDEX FOR 50 VEHICLES .85				
RATING CONE INDEX				NOTES: 1. Soil Condition: MOIST 2. Weather Conditions: FAIR				
RCI ₁ = CI ₁ X RI ₁ = 49 x .87 = 43								
RCI ₅₀ = CI ₅₀ X RI ₅₀ = 56 x .85 = 48								
VEHICLE CONE INDEX								
VCI ₁ = 35		VCI ₅₀ = 79		Will 1 vehicle pass ?		YES _____ NO _____		
Type of soil: FG <u>XXX</u> CG _____ Soil strenght profile: Normal <u>XXX</u> Abnormal _____								
Technician: Pvt. Snodgrass			Computed By: C.E.P.			Checked By: P.H.L.		

FB FM 348 1 Apr 84

Figure 3-15. Sample data table

Step 6. Determine surface roughness. Surface roughness factors are estimated factors used to compute the degree of degradation of the rate of vehicle movement caused by surface characteristics. These factors are tailored for each job by listing only those features encountered. Surface roughness is that aspect of the surface materials (such as boulder fields, gullies, and rugged bedrock.) which reduces vehicle speed.

Factors can be any number from 0.00 to 1.00 in 0.05 increments. The surface roughness factor of 1.00 for a vehicle class would indicate no degradation while a 0.80 factor would degrade vehicle speed by 20 percent. In estimating the magnitude of the factor, consider all physical characteristics of the feature as well as vehicle characteristics such as ground clearance and wheel size.

Surface roughness is classified for five types of movement categories: medium and large tanks, large wheeled vehicles, small wheeled vehicles, small tracked vehicles, and foot troops. Surface roughness factors often vary from one vehicle class to another.

Step 7. Prepare surface materials legend. Prepare a soil data table with RCI values for wet and dry seasons (see Figure 3-15). Using all available information, annotate the data elements required to complete the soil data table. This information can be used to increase the database for an area of operations.

Prepare the surface materials legend. The legend will contain only USCS soil categories with the appropriate surface roughness information. Depict additional information, such as soil depths and soil moisture from the soil data table, in the legend and within the factor overlay.

Step 8. Construct the final overlay. The final step in producing a factor overlay is to put the draft manuscript overlay into a final data-base product. Support from the cartographic and reproduction elements or sections is required. See Chapter 8 for the final overlay procedures.

OBSTACLE OVERLAY

The obstacle overlay is used to show the location and type of linear obstacles to movement. These obstacles can be either man-made or natural. This factor overlay is used with other primary factor overlays to produce cross-country mobility products and to assist military planners in developing barrier plans to tie planned obstacles into existing obstacles.

A 1:50,000 topographic map and complete stereo imagery are required to construct an obstacle factor overlay using TTADB product specifications.

Step 1. Collect required collateral data. Some of the major sources for data are maps and aerial imagery.

Standard military maps differ incompleteness and accuracy according to scale, currency and country of origin. Most existing obstacles are shown on topographic maps and can be plotted by the analyst.

Large-scale city maps can be used to plot the obstacles in and around built-up areas. The United States Geological survey (USGS) produced 1:24,000 maps show more detail than smaller scale maps. Use them as source material if they exist in your area.

Analysis of aerial imagery is the best and most accurate method of beating and plotting obstacles. Most natural obstacles, such as escarpments and embankments, are not high enough to be shown by the contour interval of a map, but they can be identified using aerial photos. Use imagery to locate and identify fences, walls, and hedgerows, which are not usually shown on standard maps.

Step 2. Prepare topographic map base. Register the overlay to the database or map you are using. Cover the selected topographic map with a clean sheet of mylar and tape them together. If the area of interest does not cover the entire map, outline the area of interest on the mylar in black pencil or ink. Mark and label the longitude and latitude or UTM coordinates of the corners.

Step 3. Identify and plot existing obstacles. Identify and plot all road and railroad cuts and fills greater than 250 meters in length and 1.5 meters in height. Start by following all of the ground lines of communication and look for areas where the terrain was altered to build a stable road or railroad. Railroads will normally have more cuts and fills to maintain a relatively flat gradient. Photo-check the cuts and falls plotted from the map and look for roads or railroads not shown on the maps. Plot the cuts and fills according to TTADB product specifications.

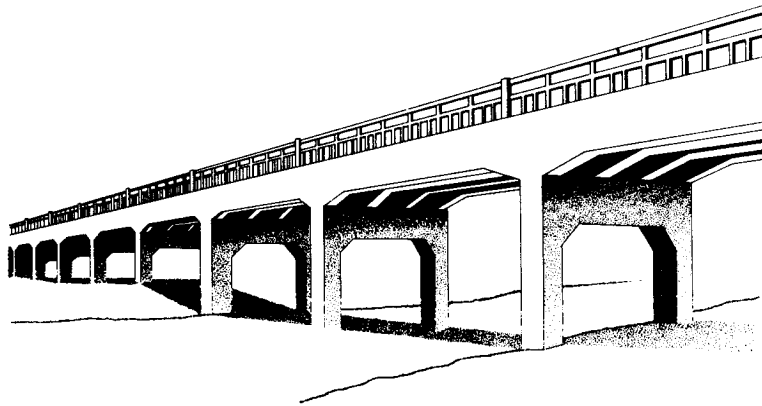
Identify and plot escarpments and embankments greater than 250 meters long and 1.5 meters high. Start by following all streams and rivers and look for areas where the contour lines converge. Look for areas where flat terrain transitions into more rugged, steep terrain. Photo-check these areas and mark the areas where escarpments, embankments, cliffs, ravines, and old stream banks exceed 45 percent. Plot the obstacles using the appropriate symbols.

Identify and plot depressions. Check geologic formations to determine if natural depressions are present. Sinkholes are commonly found in areas containing flat-lying limestones (karst topography) with historically wet climates. Topographic maps show most large depressions. Photo-check these areas and look for new pits, quarries, and open-pit mines. Plot all depressions which are greater than 250 meters long and 1.5 meters high and have slopes greater than 45 percent with the appropriate symbol.

Identify and plot other man-made features and any unique feature which can be classified as obstacles.

Step 4. Prepare the obstacle legend. Prepare the obstacle factor overlay legend according to DMA product specifications.

Step 5. Construct the final overlay. The final step in producing a factor overlay is to put the draft manuscript overlay into a final data-base product. You must have support from the cartographic and reproduction elements or sections. See Chapter 8 for the final overlay procedures.



Man-made Features

Chapter 4

Transportation Identification

Using a 1:50,000 scale map of the area, register the mylar to the base map and annotate the marginal information.

Roads

Step 1. Use the legend of the base map to locate the road classification and type of route. The route identification numbers will be located astride each road inside the route symbol. In some areas where the local government does not assign the roads identification (ID) numbers, you will need to assign arbitrary numbers.

Step 2. Trace all road segments onto the overlay using the proper symbol for each road classification. While tracing each road, look for points where either the classification or ID numbers change. Place a mute symbol at each point of change and annotate the classification and ID numbers as needed. As you trace each road, consider that interstate and federal routes do not change when crossing state or county boundaries. State roads change both classification and ID numbers when crossing state boundaries, and county roads either change classification or are terminated when crossing county or state boundaries. See Figure 4-1.

Step 3. Carefully study the base map legend and compare it the 1:50,000 (TTADB) and 1:250,000 (PTADB) product specifications to determine which factor overlay symbol to use for each map symbol.

Step 4. The surface material of each road is located in the legend across from the appropriate classification symbol. Determine which base map symbol is used in making the factor overlay and record the feature for each symbol in the legend of the factor overlay.

Step 5. Determine the width of the traveled way. Your accuracy in this will vary with the topographic map available. The FRG, USSR, and other European maps indicate the width in meters, but US maps indicate it by the number of lanes or a range of widths. Each road segment between intersections is assigned a width

<u>SYMBOL</u>	<u>HIGHWAYS</u>
	All weather, dual highway
	All weather, hard surface
	All weather, loose surface
	Fair weather, loose surface
	Cart tracks
	Width in meters (Δ denotes travelled way width change)
	Constriction (width in meters)
	Grade >7%
	Sharp curve (radius <30 meters)
	Ferry
	On route ford
	Feature under construction
	Bridge or tunnel (≥ 100m length)

Note: Only a representative pattern of major through routes and secondary roads are annotated.

Figure 4-1. Transportation legend (highways)

value, with that number placed parallel to the road segment. Table 4-1 below indicates lane widths currently shown on US military maps.

	Meters	Feet
Trail	Less than 1.5	Less than 5
Track	At least 1.5 but less than 2.5	At least 5 but less than 8
One lane	At least 2.5 but less than 5.5	At least 8 but less than 18
Two lanes	At least 5.5 but less than 8.2	At least 18 but less than 28
More than two lanes	At least 8.2	At least 28

Table 4-1. Lane widths currently shown on US military maps

Follow each route and determine the number of lanes and widths. Convert the lane width to meters to indicate the minimum width of the traveled way. Lightly record this value along the road outlined on the overlay.

Always use a decimal point when recording the road width, for example, 5 meters = 5.0 meters. Assign each road segment between intersections a width value, then place that number on the road segment. Note every point at which a change in width occurs and place a segment symbol at each of those points.

When dual routes occur, indicate the width of each route. If the source map gives only the overall width, assume each side has half the width.

Step 6. Depict gradient or percent of slope on the overlay when it exceeds 7 percent. The flat end of the first arrowhead is at the bottom of the grade, and the point of the last arrowhead is at the top. Measure the gradient from the topographic base map.

To determine percent of slope, measure the change in elevation (vertical distance or rise) and divide it by the horizontal distance (run), then multiply by 100.

$$\frac{\text{Rise} \times 100}{\text{Run}} = \text{percent slope}$$

Step 7. Show a constriction when the road narrows to less than 4 meters. Indicate the width measurement adjacent to the arrowhead symbol.

Step 8. Record all sharp curves with a radius of 30 meters or less.

Step 9. Depict all features that are currently under construction with the circled symbol *UC*.

Step 10. UTM coordinates are given for key reference points and features. See FM 21-26, which discusses map-reading instructions.

Bridges, Tunnels, Galleries, and Snowsheds

Step 1. All bridges are not usually drawn to their true scale on US military maps. Bridges less than 100 meters long are shown as point features, and bridges greater than or equal to 100 meters are symbolized by wing ticks. The only bridges not shown are located on roads that are not depicted. Plot the length between wing ticks to scale; minimum length between wing ticks is 2.0 millimeters. Point features are less than or equal to 2.0 millimeters. Draw all other features to scale.

To determine the true length of a structure, use a microcomparator and measure the feature. Multiply the length of the feature as measured by the microcomparator using the map scale to get the feature length. Record all structure lengths in the data table.

Step 2. Determine structure width. Using the road symbol, establish the width of all structures of one or more lanes directly from the map. For tunnels and fords, use only half the width indicated by the symbol, unless other information sources indicate differently. This width reduction is necessary because some structures are built with only one lane to reduce the cost of construction. See Figure 4-2.

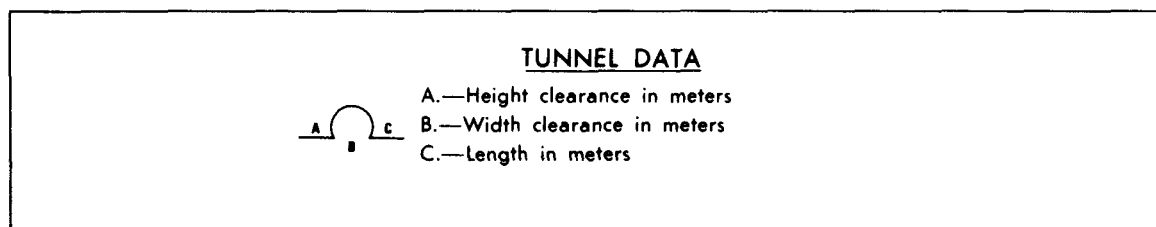


Figure 4-2. Transportation legend (tunnels)

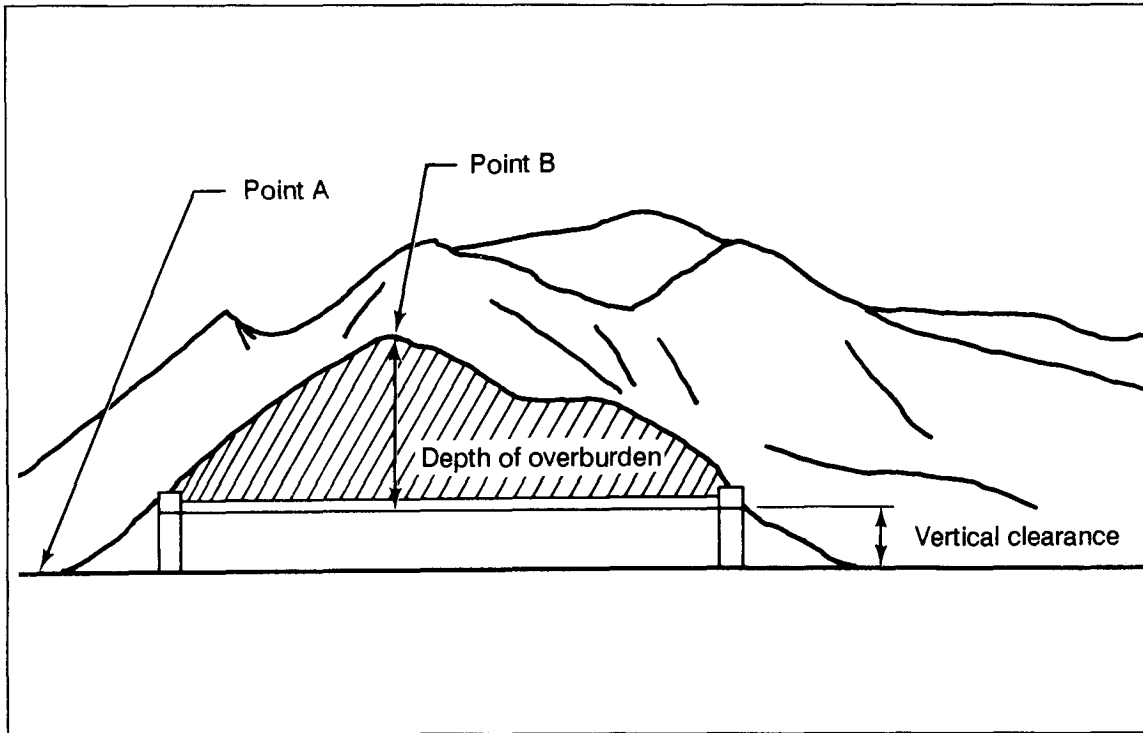


Figure 4-3. Depth of overburden for tunnels

Step 3. Determine the depth of overburden. The depth of the tunnel overburden has factual significance due to the ability to render road or railroad routes impassable to tactical units, especially if bypass capabilities are restrictive. Tunnel overburden is the material, such as soil and rock, that is directly over the tunnel structure. See Figure 4-3. You can obtain true depth determination of the tunnel overburden only by ground measurements or from DA Form 1250, Tunnel Reconnaissance Report. See Figure 4-4. You can estimate depth using aerial photography or mensuration techniques. The least effective method is to use contour lines on a topographic map. If using a topographic map, the maximum depth of the material (for example, soil or rock) laying directly over a tunnel can be estimated.

a. Determine the elevation of the road surface where it intersects with each tunnel portal. Select the portal with the lowest elevation.

b. Locate the highest contour line that passes directly over the tunnel symbol and determine its elevation.

c. Subtract the elevation determined in Step 3a from the elevation determined in Step 3b. This number is an estimated depth of the tunnel overburden. Record it on DA Form 1250 as an estimate.

Step 4. Determine bypass conditions of bridges. You can determine bypass conditions from a detailed study of the total area extending a distance of 2 kilometers on either side of the bridge. Look for the following factors when evaluating bypass conditions: steepness of bank slopes, depth of water, denseness of vegetation, roughness of surface, presence of boulders or approaches, and wet or soft ground.

TUNNEL RECONNAISSANCE REPORT				DATE
For use of this form, see FM 5-36; the proponent agency is TRADOC.				18 November 1982
TO: (Headquarters ordering reconnaissance)		ATTN:	FROM: (Name, grade and unit of reconnaissance officer)	
CDR 84th Engr BN		S2	John H. Doe, 1Lt, Co. B 84th Engr	
1. ROUTE OR LINE	2. FROM (Initial Point)	3. TO (Terminal Point)	4. DATE/TIME (Of signature)	
HIGHWAY MO 83	DL 677332	DL 678339	18 1630 Nov	
5. MAP SERIES NR	6. SHEET NUMBER	7. GRID REFERENCE		8. TUNNEL NUMBER
V734	5133II	TYPE 1:50,000	COORDINATES DL 677337	T-1
9. LOCATION FROM NEAREST TOWN				10. TYPE (Subaqueous, Rock, Soil)
DISTANCE 64 km	DIRECTION NNE	NAME OF NEAREST TOWN FANTOM		Rock
11. NAME (Mountain or Water feature)		12. LENGTH	13. NUMBER OF TRACKS	14. ROADWAY WIDTH
Blue Springs		135m	N/A	8.5m
15. CLEARANCE		16. GRADE (Percent)	17. ALINEMENT (Straight or radius of curve)	
VERTICAL 7.3m	HORIZONTAL 9.1m	4.2%	Straight	
18. LINING (Material)	19. PORTALS (Material)	20. VENTILATION (Type)		
Stone	Concrete	Natural		
21. DRAINAGE				
Adequate				
22. CHAMBERED FOR DEMOLITION		23. COMPLETED (Year)	24. CONDITION (Check appropriate box)	
<input checked="" type="checkbox"/> YES <input type="checkbox"/> NO		1921	<input type="checkbox"/> EXCELLENT <input type="checkbox"/> GOOD <input checked="" type="checkbox"/> FAIR <input type="checkbox"/> POOR	
25. BYPASSABILITY				
Difficult				
26. ALTERNATE CROSSING				
MO 671 to MO 83				
27. APPROACHES				
Good 2%				
28. IN-TUNNEL RESTRICTIONS				
None				
29. GEOLOGIC DATA				
Limestone				

DA FORM 1250
1 JAN 55

Figure 4-4. Sample tunnel reconnaissance report

<u>SYMBOL</u>	<u>BRIDGE DATA</u>
	<p>A.—Overhead clearance in meters</p> <p>B.—Military load classification for one-way wheeled traffic</p> <p>C.—Width of roadway in meters</p> <p>D.—Overall length in meters</p> <p>E.—Bridge bypass potential within a 2 kilometer distance: E = Easy D = Difficult I = Impossible</p> <p>F.—Bridge Number (See Bridge Information Table)</p>

Figure 4-5. Transportation legend (bridges)

Identify each bypass as easy (E), difficult (D), or impossible(I) on the line extending from the NATO bridge symbol to the map location. Easy obstacles can be crossed within the immediate vicinity of the bridge by a US 2 1/2-ton 6 x 6 truck (or NATO equivalent) without improving the bypass. Difficult obstacles can be crossed within the immediate vicinity of the bridge, but some work will be necessary to prepare the bypass. Impossible obstacles can only be crossed by repairing the existing bridge or constructing a new bridge. See Figure 4-5.

Fords

A ford is a location in a water barrier where the physical characteristics of the current, bottom, and approaches permit the passage of personnel and/or vehicles.

Estimate the crossing length of a ford from the map symbol by measuring the distance between the stream margins. Streams that show only one line are 25 meters or less in width and cannot be used as fords. See Figure 4-6.

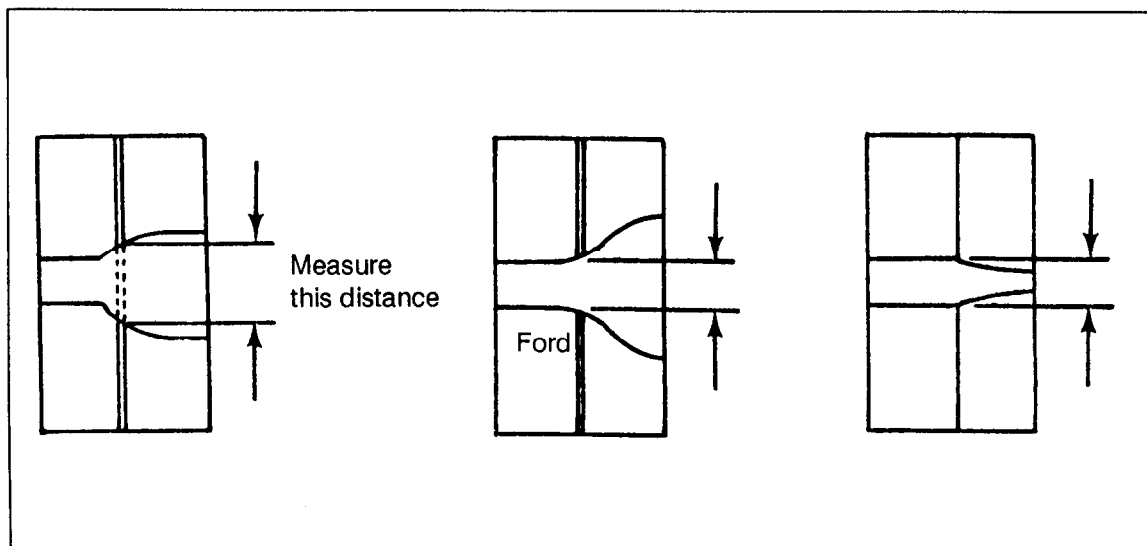


Figure 4-6. Estimating stream margins

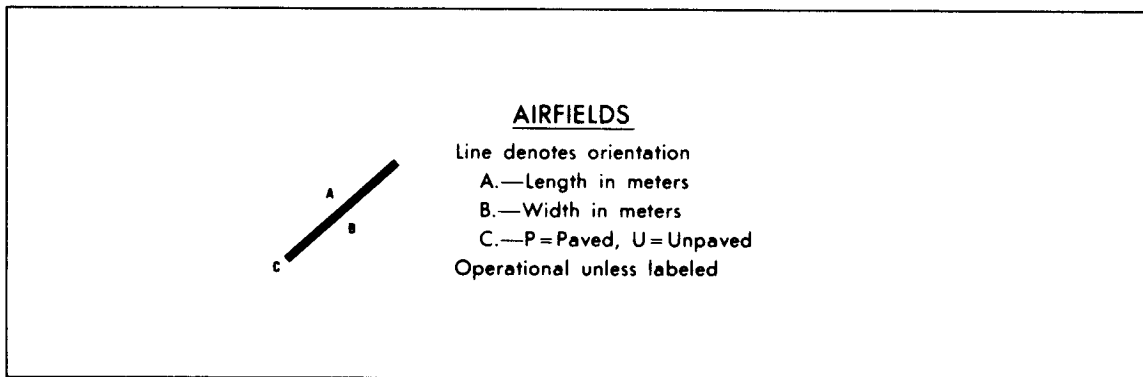


Figure 4-7. Transportation legend (Airfields)

$$\text{Estimated Ford Length} = \frac{\text{Map Scale} \times \text{Ford Length}}{1,000}$$

Divide estimated length by 1,000 to change the length to meters.

Ferries

Step 1. Determine travel distance. You cannot determine the actual distance of ferry travel by analyzing the map, because the route indicated on the map is usually an approximation. When ferry terminals are directly opposite each other, you can use the width of the river as an approximate travel distance. If the terminals are located on different maps, determine the straight line open water distance and record it on DA Form 1252, Ferry Reconnaissance Report. When you approximate distances, note this fact adjacent to the length in the reconnaissance report.

Step 2. Sketch the dimensional plan of terminals. US military maps often indicate the plan view of large ferry terminals. Sketch the dimensions of wharves, buildings, and parking lots in plan view on the ferry reconnaissance report indicating all true distances.

Airfields

The four types of data shown for airfields are length, width, pavement status, and orientation.

Step 1. Trace over the runway to show which direction the runway is oriented. At the end of each runway, indicate its azimuth to the nearest 10 degrees by dropping the zero from the numerical value and deriving a one- or two-digit number. For example, if the azimuth is 260 degrees, the number recorded on the runway is 26. Record the azimuth on the overlay.

Step 2. Measure the length and width of the runway using the map scale. If the runways are not wide enough to permit this procedure, you may place the numerals immediately adjacent to the runway. The runway length measurement should exclude the overrun area. Add the information as to whether the runway is paved (P) or unpaved (U), if you know it. See Figure 4-7.

Heliports

Heliports with runways offer evidence that they are designed for heavier wheeled cargo or passenger helicopters, while helipads accommodate rotary wing aircraft

<u>SYMBOL</u>	<u>RAILROADS</u>
	Single track, normal gauge
	Multiple track, normal gauge
	Narrow gauge
	Broad gauge
	Electrified line
	Dismantled line
	Passing track (≥280 meters)
	Siding (≥280 meters)
	Yard (total track length in meters)
	Bridge length and overhead clearance
	(U = Unlimited overhead clearance)

Figure 4-8. Transportation legend (Railroads)

that do not require a takeoff ground run to become airborne. Label the azimuths of heliports that have distinct runway orientation. Record the dimensions for width and length using the map scale and the procedure shown above in Step 2 of Airfields.

Railroads

Step 1. Determine the correct category from the map legend for railroads and select the proper symbol for each type. Then draw the railroad symbol on the overlay for each railroad in the same category. Follow the railroad throughout its length on the map, looking for points at which either the category or the ID number changes. Position the symbols to conform with mapping standards. See Figure 4-8.

Step 2. Examine the map and legend and determine the track route, gages, and locations of bridges, facilities, and crossings. Note tunnels and spurs as well as suspected crossings.

Step 3. Start tracing the alignment of the railroad across the entire sheet. Continue this process until you have traced all railroad tracks onto the overlay. Where the tracks intersect with a built-up area, continue tracing the railroad through the area. Mark lightly all pertinent features such as bridges, tunnels, and crossings. If the sheets show a track siding, trace it to its end. Measure the length of the siding in meters and record it on the overlay. If the siding has a building or facility indicated or suspected, trace and annotate its location. Certain facilities may sometimes provide electrical tracks for their privately-owned siding or spur. The

track may also become multiple along the siding or spur, if so, you must note this on the overlay.

Step 4. Whenever the route crosses a stream or creek, note the possibility of a culvert on the overlay. You must also identify all road or highway crossings on the overlay, using the proper symbol.

Step 5. Rarely will a railroad grade exceed 3 percent. If the contour interval suggests a greater gradient, note this on the overlay. A slope overlay may be available with the surface configuration overlays, if previously compiled.

Step 6. Locate and trace all railroad cut and fill areas. Much of this data will be deleted from the final overlay. Cuts are potential railroad traffic interdiction sites because of the possibility of slides induced by demolition of steep side slopes.

Step 7. Railroad bridges are normally symbolized on topographic maps. Unfortunately, the type of bridge or construction material is seldom stated. Locate all highway bridges that intersect the railroad route, as well as all railroad-carrying bridges. Draw the bridge symbol on the overlay adjacent to the site. Measure the bridge length in meters and note. This will be relevant bridge data for DA Form 1249, Bridge Reconnaissance Report.

Step 8. Identify the railroad structures. The map legend or map area may have printed data labeling various railroad facilities such as water towers and switching pits.

PHOTO ANALYSIS OF TRANSPORTATION

Oblique Aerial Photography

The scale of oblique photography is difficult to determine, because it constantly varies from the foreground to the background of the photo. If vertical aerial photography is not available and you must use oblique photography to obtain the necessary data, consult the appropriate references.

Aerial Photographic Measurements

Step 1. Determine horizontal measurements. With a magnifier, carefully determine the location of the traveled way of the bridge. Determine the distance between the curbs of the traveled way with the microcomparator, and take the measurement using the metric scale. Multiply the image measurement by the photo scale to determine the true measurement. Record this value on the bridge cross-sectional sketch on DA Form 1249. Determine the length of bridge number 1 by first locating, under stereo viewing conditions, the abutments at each end of the bridge. With the microcomparator, measure the distance between the abutments. Multiply this image distance by the photo scale and record it at the proper place on your sketch. If the bridge is composed of a number of spans, record them on the sketch and in the Bridge Reconnaissance Report.

Step 2. Determine vertical measurements. Obtain vertical measurements, such as the vertical clearance of the bridge and the under-bridge clearance, from stereo aerial photography by using a parallax wedge or bar. Measurements made with these instruments are more accurate than those obtained from a map, but they are

not as accurate as those obtained from on-site measurements or from as-built drawings. Record the distance on the cross-section sketch on the Bridge Reconnaissance Report.

Step 3. Determine under-bridge clearance. Determine the under-bridge clearance (using the same method) by measuring the difference in elevation between the bridge deck and the surface of the feature passing beneath the bridge. Since the bridge substructure will not be visible to you, you will need to estimate the height of the substructure and subtract it from the computed under-bridge clearance distance. Record the under-bridge clearance distance on the sketch on the Bridge Reconnaissance Report.

Step 4. Determine height. Use the parallax bar to determine height. Orient photos and secure them with tape.

Surface Materials and Conditions

Step 1. Estimate surface materials. Figure 4-9 lists the general air photo characteristics of road surface materials. Compare the photo appearance with the table, and estimate the surface material during the map analysis. Consider the route category when the type of material is not readily apparent. For example, national routes are usually concrete or bitumen, while country roads are often gravel.

Step 2. Estimate surface conditions. Surface condition is difficult to estimate except from very large-scale photography. Look for evidence of frequent patching, checks, broken edges, potholes, ruts, and frost or heat heaving.

Step 3. Determine surface materials of medians and shoulders. These materials may be bare ground, grass, trees, shrubs, gravel, bitumen, or concrete. In some instances, the median may be only a wall or barrier and will be difficult to detect. Therefore, use the largest photos and the highest practical magnification available.

Bridges

Step 1. Identify structure features, using oblique photography. Because they provide a side view of the structure, oblique photos are the best some to determine construction type, material, length, overhead and under-bridge clearances, number and type of span, and length of individual spans. Measurement is dependent on careful, accurate determination of the scale. When practical, make duplicate measurements on vertical photography and average the results.

Step 2. Measure bridge features using vertical photography. Measurements on vertical photos are usually more accurate than similar measurements made on oblique photographs, but vertical photos do not provide the side view so useful in determining the type of construction. A definite shadow of the bridge often provides much of the same information available from oblique coverage. When no shadow of the bridge exists, examine the surrounding vertical photographs and look for an image of the bridge that falls near the edge of the photograph. Images near the edge of vertical photos are often displaced or tilted so that the side of the object is visible.

Step 3. Determine the military load class. You cannot determine the military load class directly from aerial photography, but you can roughly estimate it from vehicles that were using the bridge at the time the photo was taken. Examine the

AIR PHOTO CHARACTERISTICS OF ROAD SURFACE MATERIALS					
FILM TYPE	CONCRETE	PAVING STONE	BITUMEN	GRAVEL	SOIL
Panchromatic	<ul style="list-style-type: none"> Center line present Definite margins Light tone 	<ul style="list-style-type: none"> Center line present Light to dark tone depending on materials Pattern of blocks may be detectable 	<ul style="list-style-type: none"> Center line present Indefinite margins Dark tone 	<ul style="list-style-type: none"> No center line Indefinite margins Light to dark gray tone 	<ul style="list-style-type: none"> No center line Indefinite margins Tone dependent on soil color
Black and white infrared	<ul style="list-style-type: none"> Center line present Definite margins Light tone 	<ul style="list-style-type: none"> Center line present Light to dark tone depending on material Pattern of blocks may be detectable 	<ul style="list-style-type: none"> Center line present Indefinite margins Dark tone 	<ul style="list-style-type: none"> No center line Indefinite margins Light to dark gray tone 	<ul style="list-style-type: none"> No center line Indefinite margins Tone dependent on soil color
Color	<ul style="list-style-type: none"> Center line present Definite margins Light tone 	<ul style="list-style-type: none"> Center line present Light to dark tone depending on material Pattern of blocks may be detectable 	<ul style="list-style-type: none"> Center line present Indefinite margins Dark tone 	<ul style="list-style-type: none"> No center line Indefinite margins Light to dark gray tone 	<ul style="list-style-type: none"> No center line Indefinite margins
Color infrared	<ul style="list-style-type: none"> Center line present Definite margins Light tone 	<ul style="list-style-type: none"> Center line present Light to dark tone depending on material Pattern of blocks may be detectable 	<ul style="list-style-type: none"> Center line present Indefinite margins Dark tone 	<ul style="list-style-type: none"> No center line Indefinite margins Light to dark gray tone 	<ul style="list-style-type: none"> No center line Indefinite margins

Figure 4-9. Air photo characteristics of road surface material

photos and identify any vehicles on the bridge. If you can estimate the load class of the vehicle, you can assume that the class of the bridge is at least the same. If no vehicles are actually on or approaching the bridge, the load class cannot be estimated.

Step 4. Identify construction type and materials. On large-scale aerial photography (1:2000 to 1:15,000) such as panchromatic and color, you can easily identify construction type and materials such as masonry, wood, steel-reinforced concrete, and steel by indicators on the photos. These indicators include shadow and photographic tone, color, and texture. With detailed study of the photographs, especially under stereo conditions, you should be able to determine not only the type of construction but also the major structure composition.

Step 5. Determine bypass conditions. The standard topographic map will supply all the necessary information to determine bypass conditions for each bridge and LOC structure. However, you must use aerial photography to continuously update the map, particularly under combat conditions. To determine bypass conditions from aerial photography, study the area adjacent to the structure under stereo conditions and note any indications of shallow water, such as sandbars or rocks, that are visible through the water surface. In addition, look for vehicle tracks along the river bank that indicate the location of an existing ford. When the structure is a dam used as a bridge, examine the downstream side of the dam, where the water is often shallow enough to be used as a bypass. Because dams are almost always situated where bedrock is close to the surface, stream bottom conditions are usually firm enough to support most vehicle types.

Ford Width

Look for indications that the roadway continues across the channel, such as two faint lines that mark the sides of the traveled way. On some fords, the sides of the roadway are marked by boulders that appear on the imagery. Where the ford has been raised by adding material to the bottom of the stream, the sides may appear as lines of ripples or as eddies of a lighter tone than the surrounding water. Measure the width.

Ford Bottom Characteristics

Determining ford bottom characteristics such as paved, rocky, and sandy from aerial photography depends on a number of factors. They include water depth and clarity, film type, and photo scale. To determine this data, orient aerial photos of the ford for stereo viewing using proper procedures. Study the area around the ford, as well as the river or stream channel both upstream and downstream of the ford.

Rapids, white water, and exposed rocks or boulders indicate a rocky bottom. Bars, braiding, and steep banks often indicate coarse-grained material such as sand or gravel. Meanders and oxbows in the immediate vicinity indicate relatively slow-moving streams with fine-grained material. Angular drainage patterns with frequent sharp changes in direction indicate rock control and a rocky bottom. In swift-flowing streams in mountainous areas, fine materials do not settle; therefore, the bottoms are usually rocky or firm.

Length of Ferry Crossing

You can easily determine ferry crossing length from aerial photography if both terminals appear on a single photograph. If two or more photos are required, construct a mosaic of several photos.

Single Photo Method

Determine the scale of the photo, using proper procedures. Locate terminals and measure the open-water distance between terminals with the microcomparator or PI scale. Multiply the measured distance by the denominator of the representative fraction to determine true distance.

Mosaic Method

Determine the number of photos required to cover the entire open-water distance between ferry terminals. Secure the photo containing the most western terminal to a suitable flat surface. Carefully place the adjacent photo over the edge of the first photo, aligning common terrain features of Photo 2 with Photo 1. Continue this process until the second ferry terminal appears on a photo. Check your work, making certain that all photos are properly aligned.

Scale the open-water distance between ferry terminals. Multiply the photo distance by the denominator of the photo representative fraction.

Ferry Terminal Layout

Step 1. Orient the photos for each terminal, using proper procedures, and examine the terminal facilities and approaches.

Step 2. Examine the land facilities. Look for large buildings, parking lots, winches, guy-line towers, and any other features that may affect the use or capacity of the site. When feasible, determine the dimensions of the site and major structures.

Step 3. Examine the water approaches. Look for obstacles, fenders, piers, pilings, and evidence of the channel.

Step 4. Analyze vessel information such as ferry length, beam, and capacity. To do so, you will need to orient photos, locate one or more of the vessels, and determine the photo scale. With the microcomparator, measure the length and width of each vessel. Multiply the photo distances by the denominator of the photo scale to determine true distances.

Step 5. Estimate the number of vessel decks capable of carrying vehicles. Assume an automobile size of 2 by 6 meters and a weight of 2 tons.

Step 6. Estimate vehicle capacity for one deck of the vessel. Multiply this number by the number of decks. If all vessels do not have the same length and beam, measure and record each vessel separately.

Step 7. Examine approach conditions for fords and ferries. Approaches are classified as easy when the slope is 7 percent or less; the surface is relatively smooth with no ruts, potholes, or other obstacles; the width is at least 3 meters; there are no sharp curves within 50 meters of the water's edge and the surface is well drained

or free of standing water. Failure to meet all of these conditions will result in the approach being classified as difficult.

Airfields

Step 1. Using the PI and photographic scales, measure the length and width of the runway. Record the measurements in meters on the factor overlay within the runway boundary lines or beside the runway.

Step 2. Determine the surface material of the runway using the information in Table 4-2. Label runways with hard or paved surfaces with a *P*, and loose or unpaved surfaces with a *U*.

AIRFIELD SURFACE MATERIALS INFORMATION			
Type of surface	Surface outlook	Color	Other
Sod	Irregular	Brown to green mottled (color photos)	Tire tracks
Graded earth, gravel, sand, coral, clay (sources of surfacing material)	May have grader marks	Light to dark color, mottled	Open pits in the vicinity
Pierced metal	Grid pattern	Brown to green, mottled	Piles of plank in area
Concrete	Smooth, surface may be patched or painted	Light gray to white, uniform	Block pattern
Asphalt	Smooth, surface may be patched or painted	Very dark to light gray, usually uniform	None

Table 4-2. Airfield surface materials information

Step 3. At most major airfields, the magnetic alignment of runways is painted in large numerals at the ends of the paved surfaces. These azimuths, contrasting with the runway coloration, may be legible on aerial photography. Transfer these values to the ends of runways shown on the factor overlay. If the numerical designations of runway azimuths do not appear or are illegible on the photography, measure the magnetic orientation of each runway and enter the values at the ends of the runways.

Railroads

Step 1. From the stereo pairs, locate the area of the railroad to analyze. Compare the date of the photographs with the date of the last map revision or update. If the photographs are more recent than the map, use them. If the map is more recent, give greater weight to the map information however, even if it is more recent, it should not always take precedence over the photographs, because map information is often general. As a result, some feature such as sidings are not shown.

Step 2. Look for any railroad sidings not shown on the map. Compare the outline of all built-up areas on the photos with the map symbols of the same areas. Lightly sketch any new alignments or built-up areas onto the overlay in pencil.

Step 3. Verify the location of each segment end point. If the end points determined from the photo differ from those obtained from the map, use the points obtained from the photos. Relocate the endpoint symbols on the overlay, renumber the segments if necessary, and determine the coordinates of the relocated points. Change entries in the railroad data tables if necessary.

Step 4. Verify the gradient of each segment that has a grade of 3 percent or greater.

Step 5. Examine aerial photography to verify the location of culverts or streams. The map indicates the location of culverts or streams passing beneath the railroad. Also check all areas on the photos where a stream or drainageway intersects a railway. If these areas indicate culverts, annotate the overlay at each location. Make notes in the data tables as necessary.

Step 6. Locate built-up areas on aerial photos that show railway through-routes. Locate any zones where buildings, walls, and so forth constrict the width of the route to less than 4 meters. Measure the constrictions, using the microcomparator or the PI scale, and record the data in the proper place on the overlay.

Step 7. Examine and verify areas previously identified as level crossings. Make additions, deletions, or changes on the overlay as required.

Step 8. Determine catenary clearance. The clearance beneath the catenary is required only if the railroad under study is electrified and uses overhead wires. The catenary clearance is seldom shown on maps. Photos may provide some indication of catenary clearance. If not, place a question mark above the crossings on the overlay to indicate there are overhead wires but the clearance is unknown.

Step 9. Assemble the vertical photos that provide stereo coverage for each bridge recorded on the factor overlay. If oblique photos are available, place them with the vertical ones. Study the material carefully to become familiar with the general characteristics of the bridge. Determine the number of spans, overhead clearance, and so forth. Measure the roadbed widths. Record all data in Railroad Data Table 2 or annotate it on the overlay.

Inland Waterways

Classify inland waterways according to their depths. Very shallow waterways have depths less than 1.4 meters. Medium waterways have depths between 1.4 and 2 meters. Deep waterways have depths greater than 2 meters. See Chapter 2 for more information.

Facilities and Installations

Step 1. Identify all wharves. Figure 4-10 shows a reference diagram of a wharf.

Step 2. Identify all locks. Common types of locks are single and multiple-chamber. See Figure 4-11. Gates are the most vulnerable features of a lock. Common types of gates are--

- Double-leaf miter gates (see Figure 4-12). A pair of hinged gates that form a V or angle across the end of the lock when closed. The apex is always upstream to use the head of water to keep the gates closed.
- Single-leaf miter gates. Hinged gates that pivot into a recess in the lock wall. See Figure 4-13.
- Vertical-lift gates. Lock gates that move in a vertical plane. Those gates are usually suspended from an overhead frame and counterbalanced.

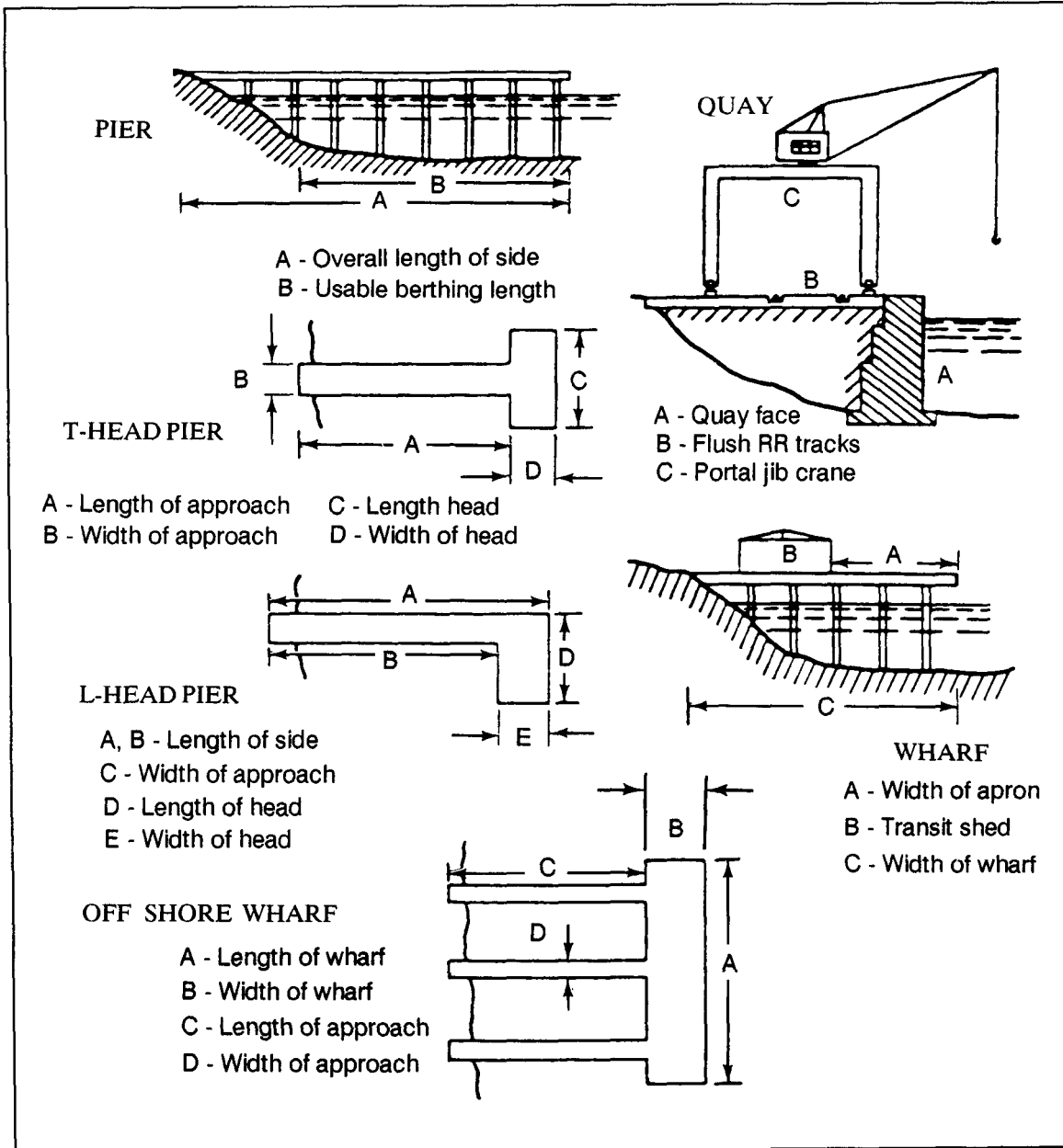


Figure 4-10. Wharf reference diagram

- Caisson or sliding (retractile) gates. Those gates move horizontally into wells or caissons when open.
- Segmental gates. A pair of gates shaped like sectors of a cylinder. They are hinged at the sides and rotate into wells.

Step 3. Prepare final overlay. See Chapter 8 for procedures.

URBAN AREAS

Step 1. Obtain a 1:50,000-scale map covering the area of interest. Register the mylar to the map or data base and annotate the marginal information. Then locate and outline all areas that cover the area to be studied.

Step 2. Establish a numerical priority listing (ranking) of urban areas to be analyzed at a scale of 1:12,500. Determine this sequence based on whether the areas are administrative centers (state and national capitals, strategic centers of

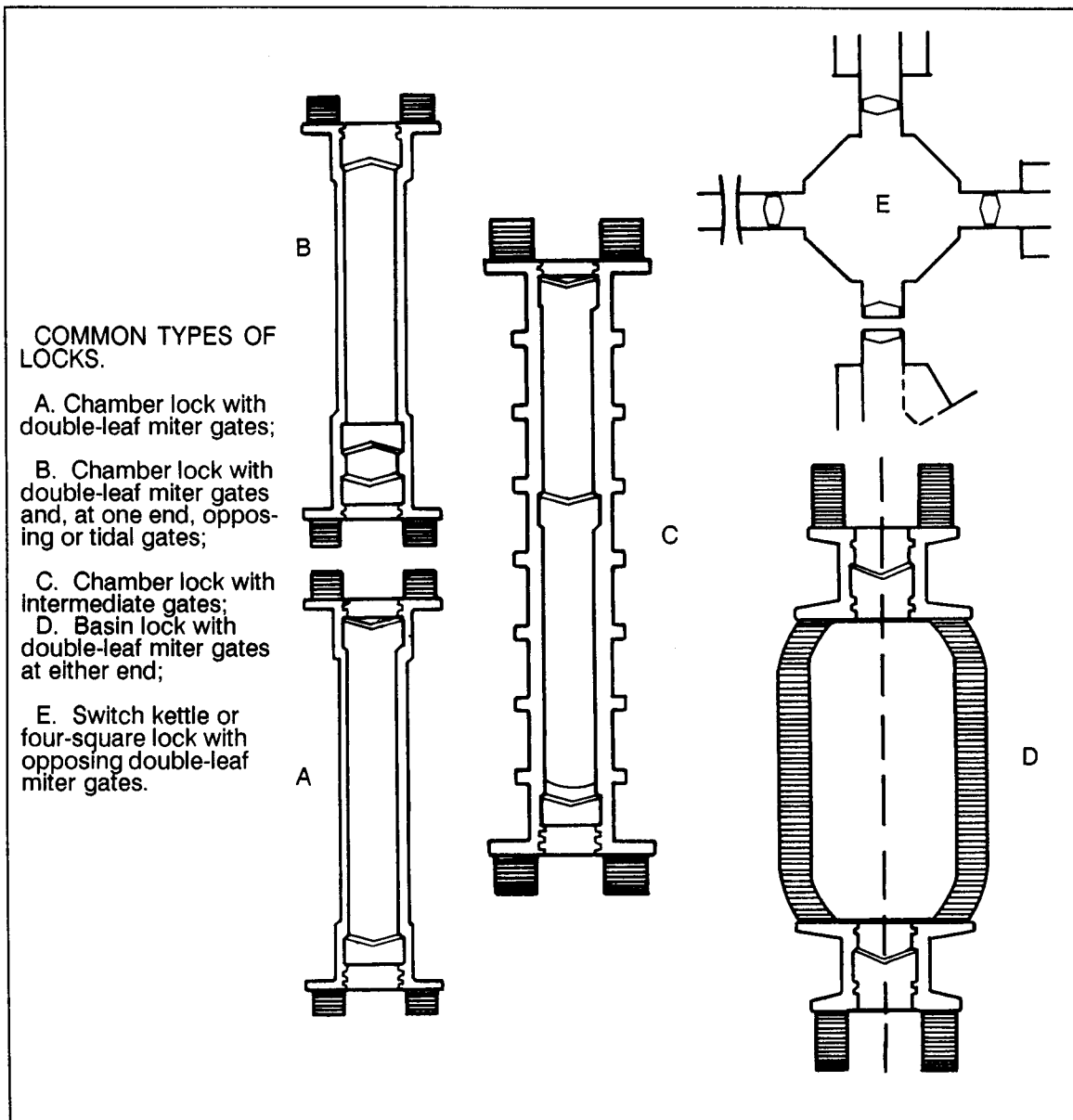


Figure 4-11. Types of locks

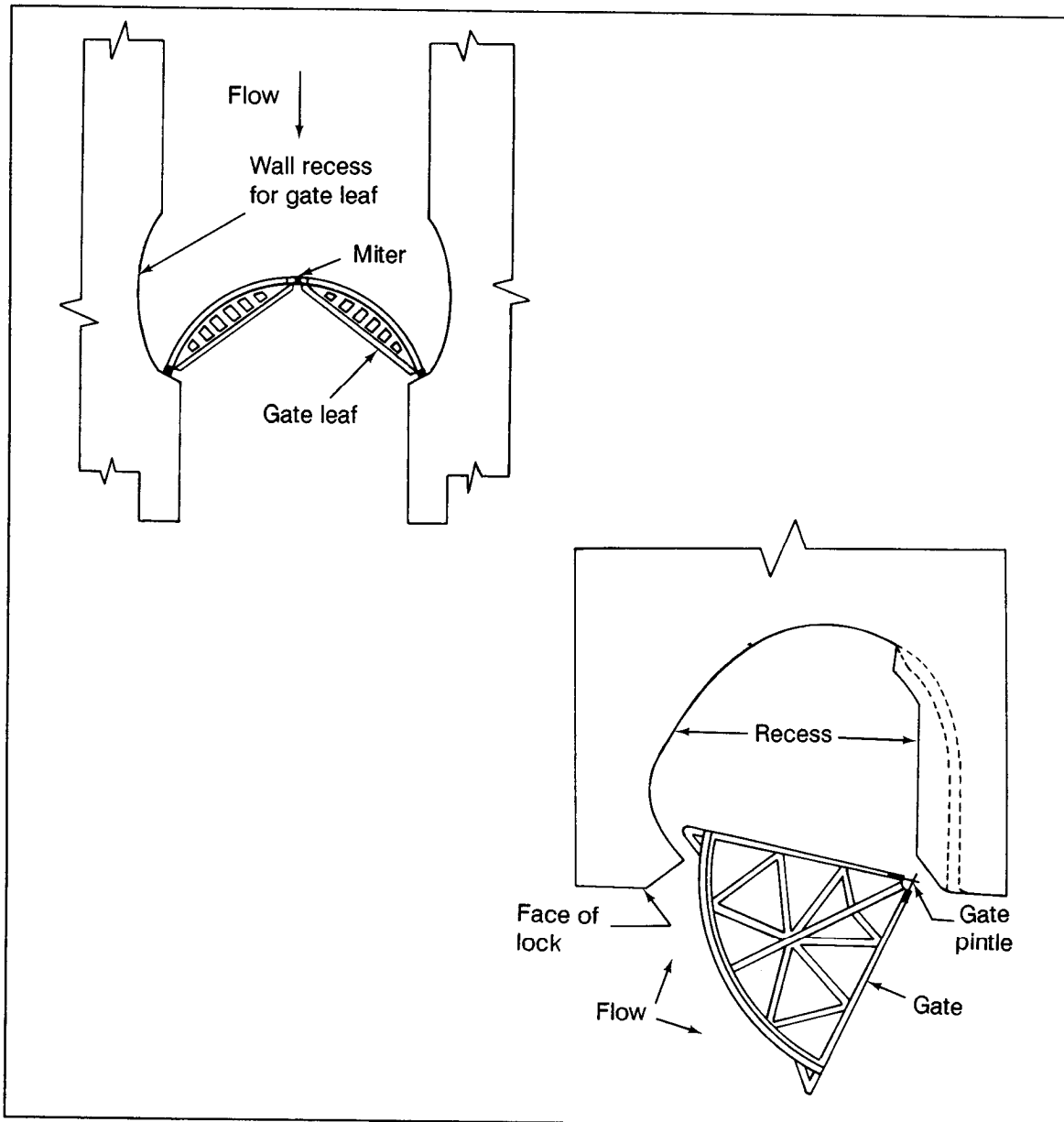


Figure 4-12. Miter gate locks

production, steel, manufacturing, and nuclear power plants), or are located on dominant ground or on major avenues of approach.

Step 3. Assign a priority number to each urban area and carry out the analysis accordingly. Where all urban areas on a 1:50,000-scale map are to be analyzed without concern for priority consideration, number each area, beginning at the top left corner of the identification overlay, and proceed across and down the map.

Step 4. Retrieve a 1:12,500-scale topographic map of the urban area. If you cannot find any, outline the desired area on the 1:50,000-scale map and enlarge this map segment by 400 percent. If a 1:25,000-scale map is available, you may enlarge

it by 200 percent. The enlarged map will become the base map to which all factor overlays will be registered.

You will require multiple overlays to extract information for the data fields documented in order to map adequately the diverse terrain features that makeup the urban area. In this regard, the number of overlays to be used is considerably greater than the number used in other areas. Some topics include vegetation, roads and related structures, drainage and water resources, and railroads and related structures. Because of the larger scale of the urban-area products and the complexities inherent in this unique terrain, some elements are portrayed differently from those depicted on overlays keyed to 1:50,000-scale maps.

Step 5. Determine the area to be analyzed and gather all necessary aerial photographs in stereo pairs to cover the area. Orient them for stereo viewing.

Step 6. View the photographs in stereo and use the PI keys and text to determine the urban type in the aerial coverage. Then analyze, outline, and identify all types and label them with the appropriate urban code.

Step 7. Determine the roof coverage. Density refers to the ratio of roof area of buildings to total ground area, including streets and small open spaces. To determine roof cover percentage from aerial photography, collect the necessary stereo pairs for the area to be analyzed and note the photo scale. Measure the footage of the area, both the length and width, with a thousands-foot scale and multiply it by the photo scale.

$$\begin{aligned}GD &= PD \times PSR \\ \text{Area} &= L \times W\end{aligned}$$

Where--

GD = ground distance
PD = photo distance
PSR = photo scale reciprocal
L = length
W = width

Step 8. Determine the roof size by measuring the average roof in the area the roofs should all be about the same size. Using the microcomparator, measure the length and width of an average roof and multiply it by the photo scale. Then count the number of buildings and multiply that number by the area of the roofs. To determine the percentage of the roof coverage, take the roof size times the number of buildings in the area, divide it by the total area, and multiply it by 100.

$$\frac{\text{Total area of buildings} \times \text{Number of buildings in area} \times 100}{\text{Total area size}} = \% \text{ Roof coverage}$$

Figure 4-13 will help determine the percentage of roof coverage and the percentage of concealment from aerial detection. Use the appropriate symbol to mark the overlay.


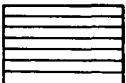

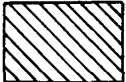
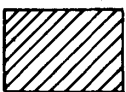
Symbol	% Roof coverage	Category	Concealment
5 	75-100	Congested	Excellent
4 	50-75	Dense	Good
3 	25-50	Moderate	Fair
2 	5-25	Sparse	Poor
1 	0-5	Open	None

Figure 4-13. Concealment from aerial detection and percentage of roof coverage

Step 9. Determine construction and building type. Make appropriate annotations for type of construction or building, using the definitions below. Note: Building types 5 through 8 are comprised of multistory office and apartment buildings. For the purpose of classification and subsequent evaluation, each category is divided into low-rise buildings of six stories or less and high-rise structures in excess of six stories.

- **Type 1.** Wood and timber frame construction. Most farm buildings and those buildings constructed prior to the late 19th century are classified as Type 1. Their ceilings with wooden rafters and weak exterior walls offer little protection from indirect or direct weapons fire. Internal communication routes are excellent since their lightly constructed walls are easy to breach; however, significant reinforcement is required to provide protective cover if such buildings are to be used as defensive positions. Within larger built-up areas, Type 1 buildings present the greatest fire hazard. See Figure 4-14.
- **Type 2.** Masonry construction. Buildings with strong walls of brick or natural stone constructed in the 19th and early 20th centuries are classified as Type 2. These buildings, typified by the old town hall, are commonly found in the central areas of towns and cities. They generally contain from two to four stories with ceilings with wooden rafters and lightly constructed tile roofs. Presenting less of a fire hazard than wood and timber frame structures, Type 2 buildings are frequently suitable as defensive positions. While internal communication routes are excellent, external walls are difficult to breach without heavy weapons or demolitions. See Figure 4-14.

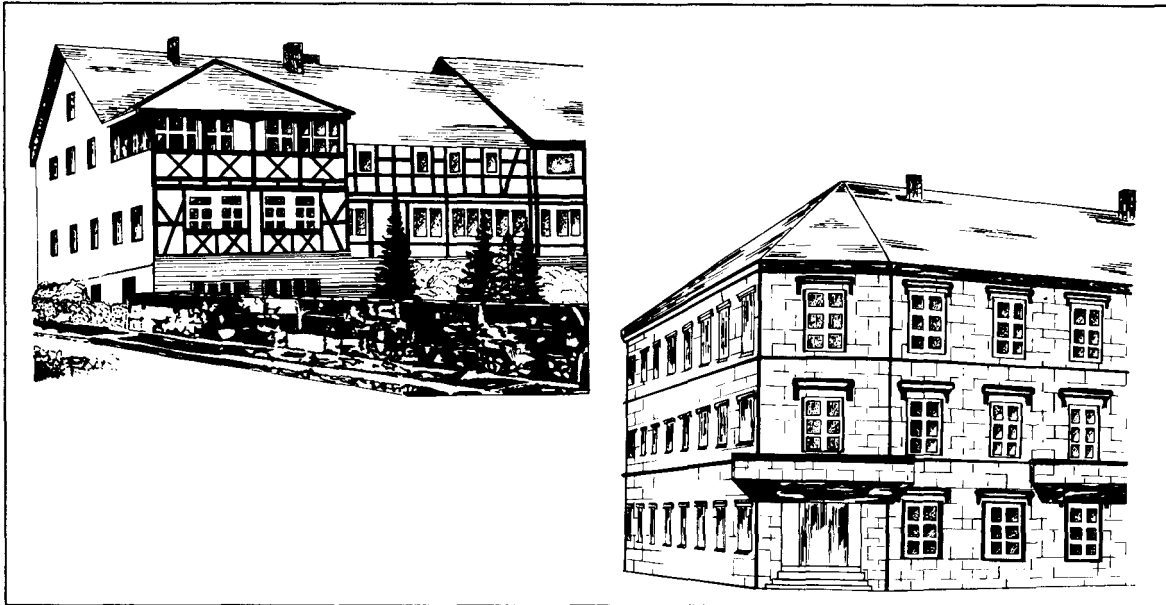


Figure 4-14. Examples of construction/building type (wood and frame and masonry)

• *Type 3.* One- or two-family dwellings. Family dwellings constructed of solid or insulating bricks or of cinder blocks with ceilings of reinforced concrete are classified as Type 3. Such buildings frequently contain strongly constructed basements. Type 3 buildings offer significant protection and require little reinforcement if used as defensive positions. Because of Type 3 construction, fire hazards are minimal. If demolished, significant rubble is generated, offering protection to the defender or creating an obstacle to the attacker. See Figure 4-15.

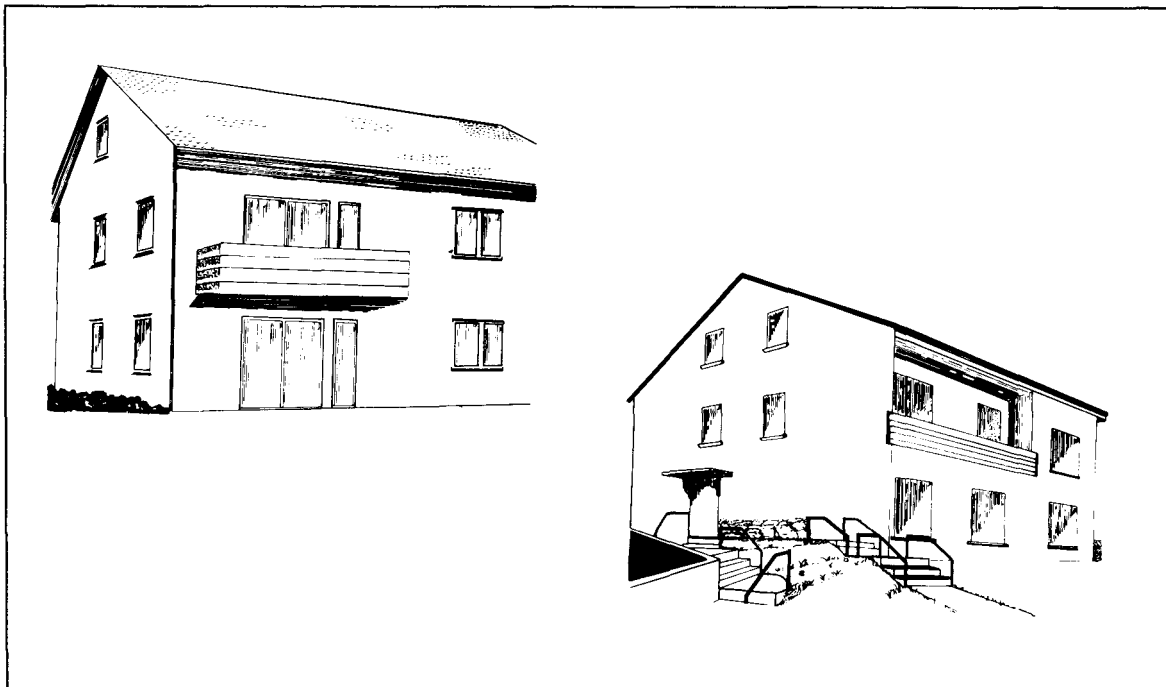


Figure 4-15. Example of construction/building type (family dwellings)

- *Type 4.* Prefabricated one-family dwellings. Prefabricated family dwellings assembled with precast and light building materials are classified as Type 4. In most cases, the cellars or basements are strongly constructed. Unlike Type 3 dwellings, these buildings require significant reinforcement if they are to be used as defensive positions. They also constitute a fire hazard in a freed defense. Rubble produced by their destruction creates an effective obstacle and additional cover for ground-level defensive positions. See Figure 4-15.
- *Type 5.* Low-rise office buildings. Multistory office buildings, with their steel frame and reinforced concrete construction, are normally characterized by large expanses of plate glass which offer little protection. See Figure 4-16.
- *Type 6.* High-rise office buildings. These buildings are also characterized by large expanses of plate glass which offer little protection, but they have six stories or more.
- *Type 7.* Low-rise apartment buildings. While similar in size to low-rise office buildings, they generally have smaller glass areas and load-bearing reinforced concrete exterior walls which provide greater protection.
- *Type 8.* High-rise apartment buildings. See Type 4, paragraph 2. See Figure 4-16.
- *Type 9.* Buildings common to newer industrial and warehouse complexes are classified as Type 9. While the type construction may vary considerably, steel framing and the use of lightweight materials for exterior walls and roofs are normal practices. Reinforced concrete floors and ceilings are frequently used in multistory buildings.

Figures 4-17 through 4-31 show examples of industrial areas that will be useful in identifying specific subdivisions of the industrial classification.

This completes the urban analysis procedure. See Chapter 8 for final overlay preparation procedures.

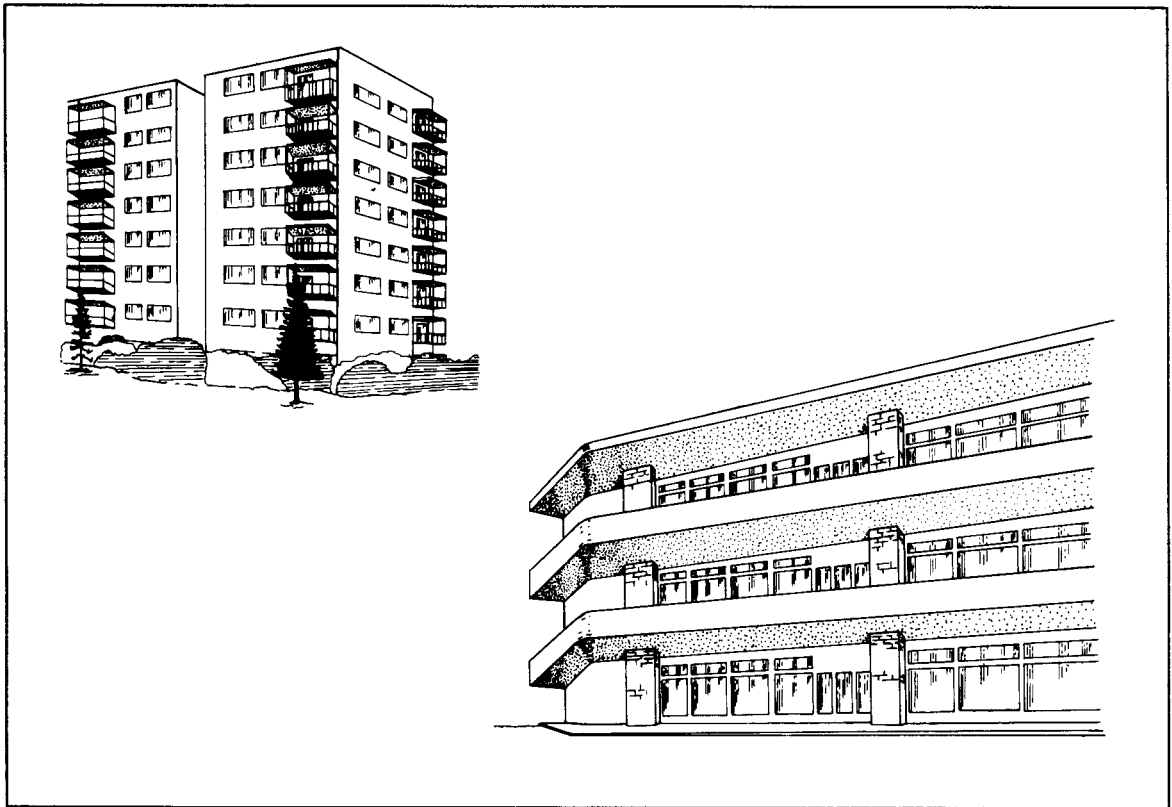


Figure 4-16. Example of construction/building types (multistory buildings)

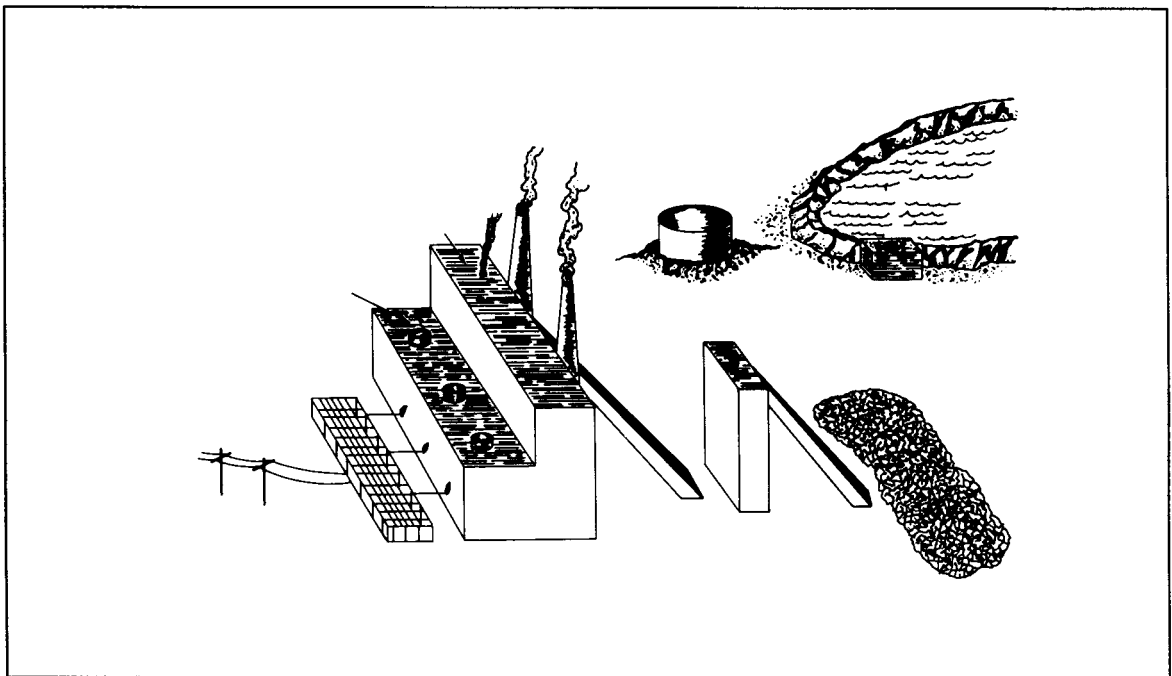


Figure 4-17. Example of a construction/building type (thermal electric power plant)

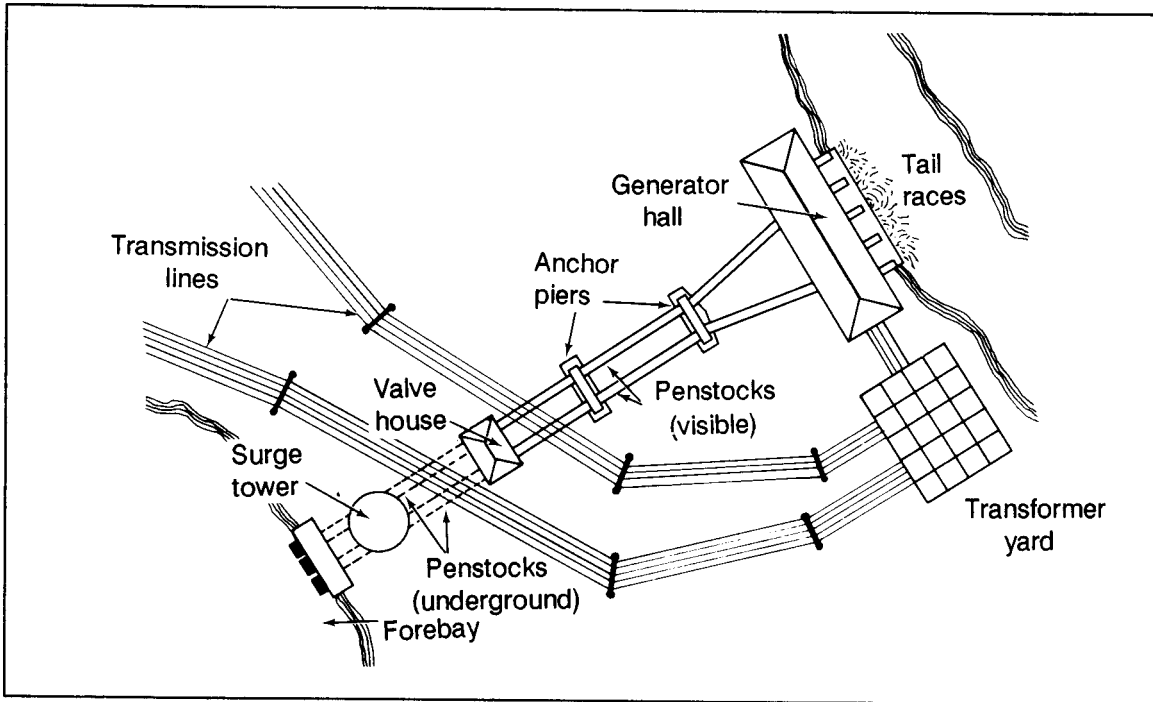


Figure 4-18. Example of construction/building type (penstock type hydroelectric power system)

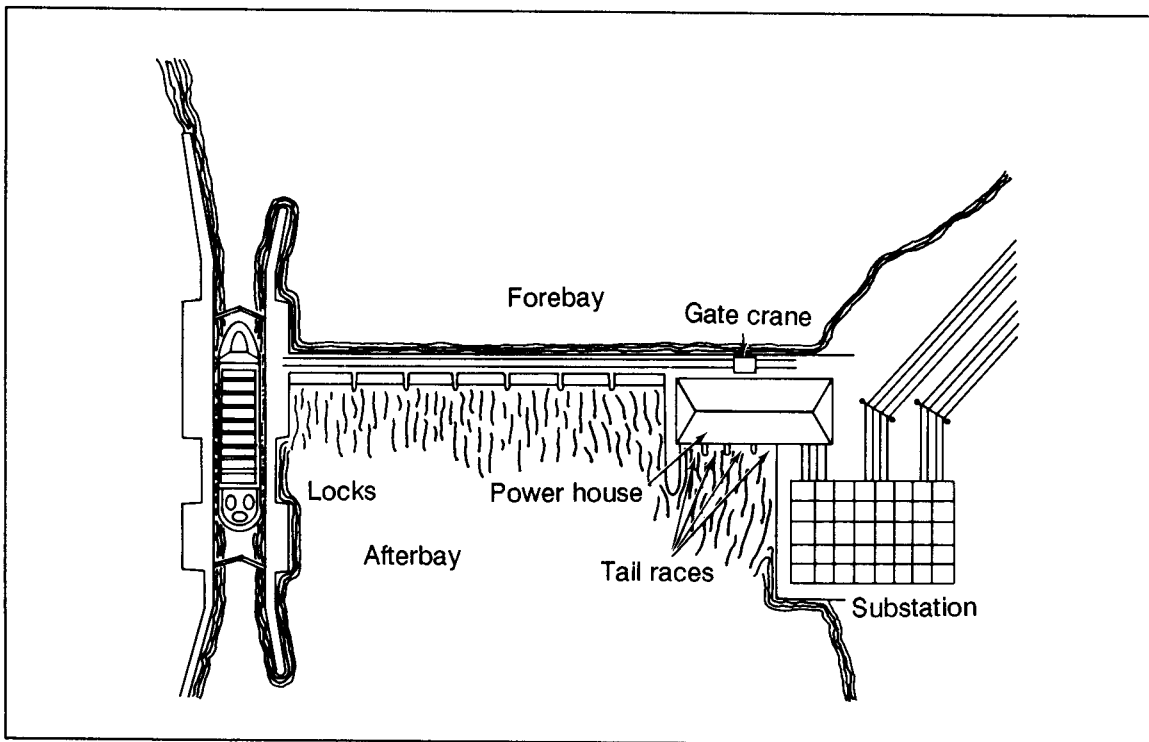


Figure 4-19. Example for construction/building type (low dam type hydroelectric power system)

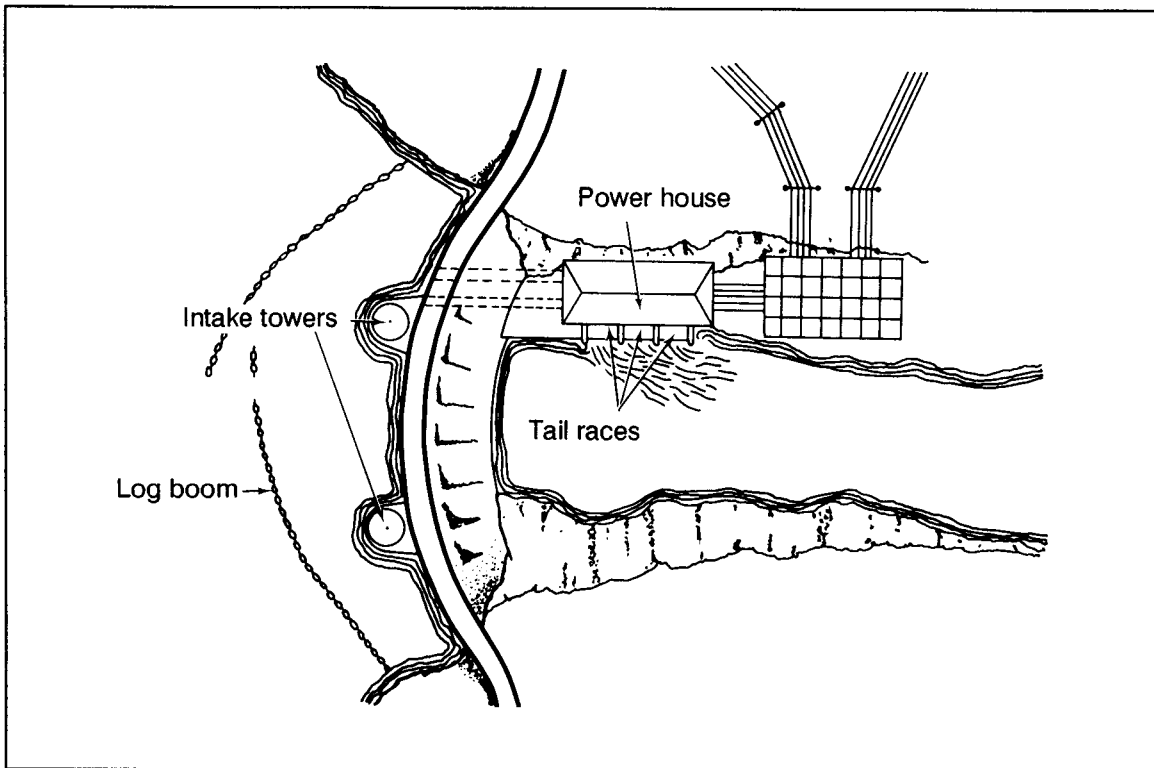


Figure 4-20. Example of construction/building type (high dam type hydroelectric power plant system)

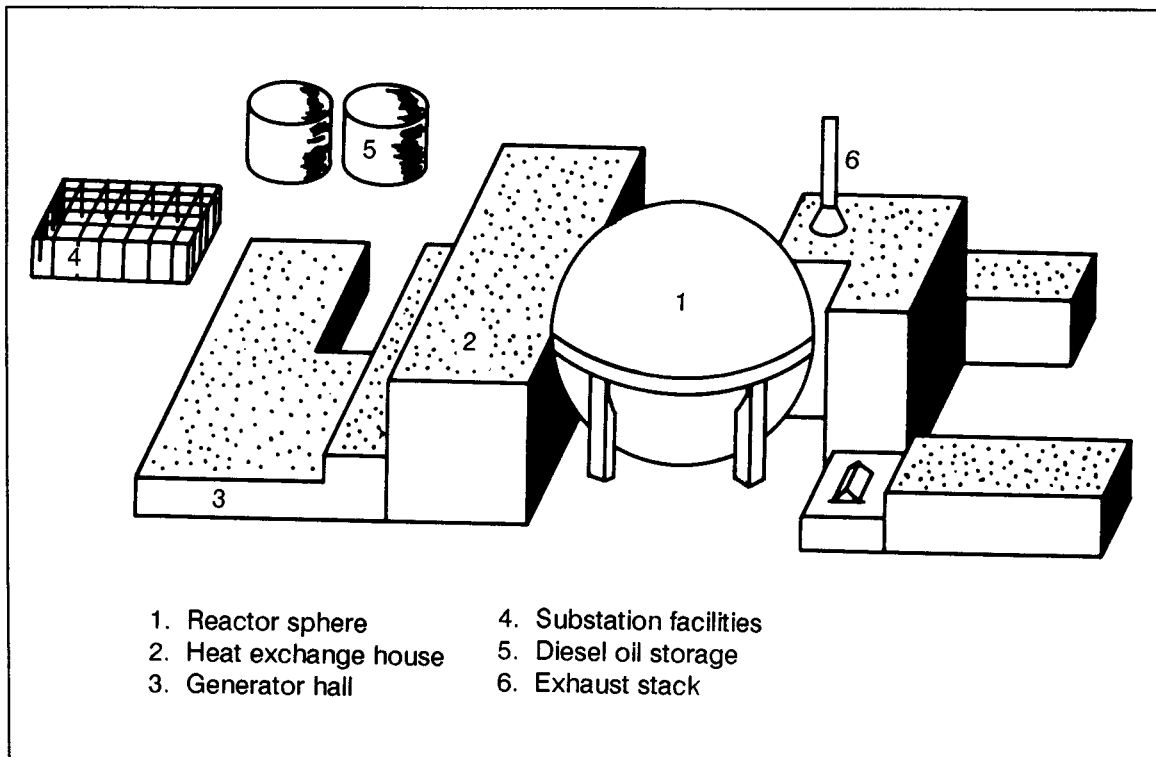


Figure 4-21. Example of construction/building type (thermal nuclear power plant)

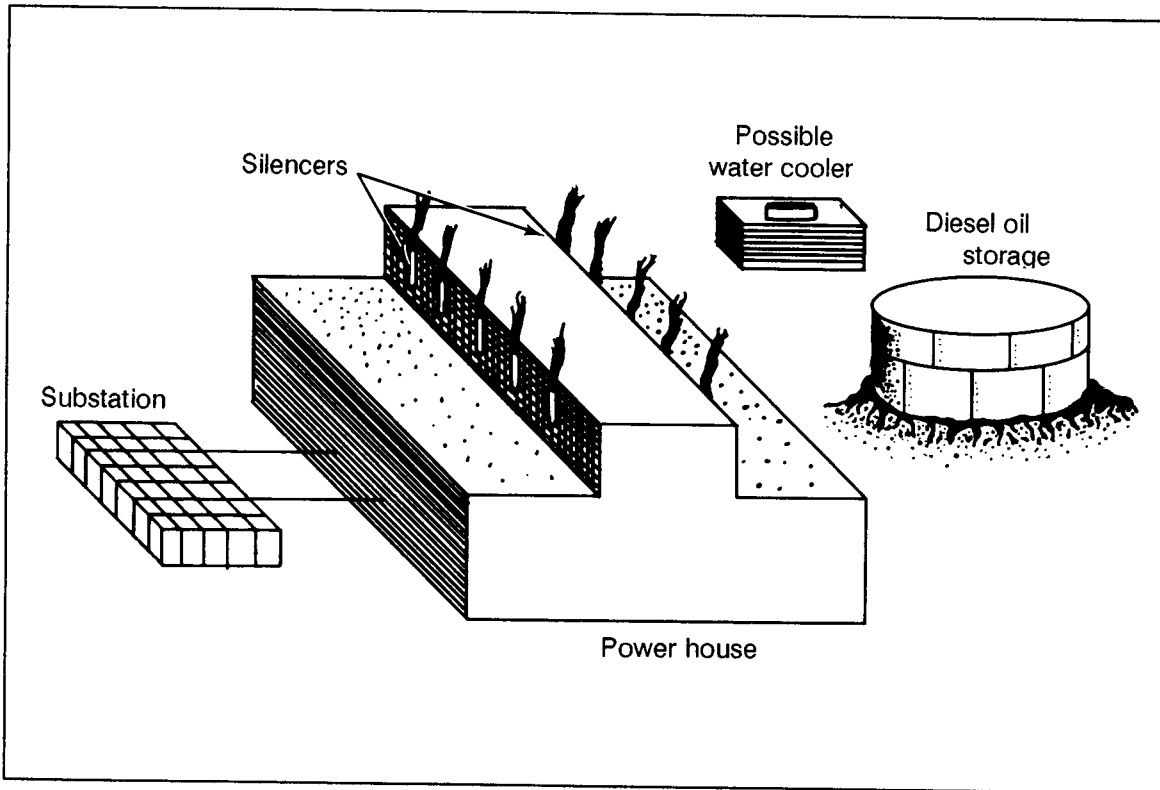


Figure 4-22. Example of construction/building type (internal combustion power plant)

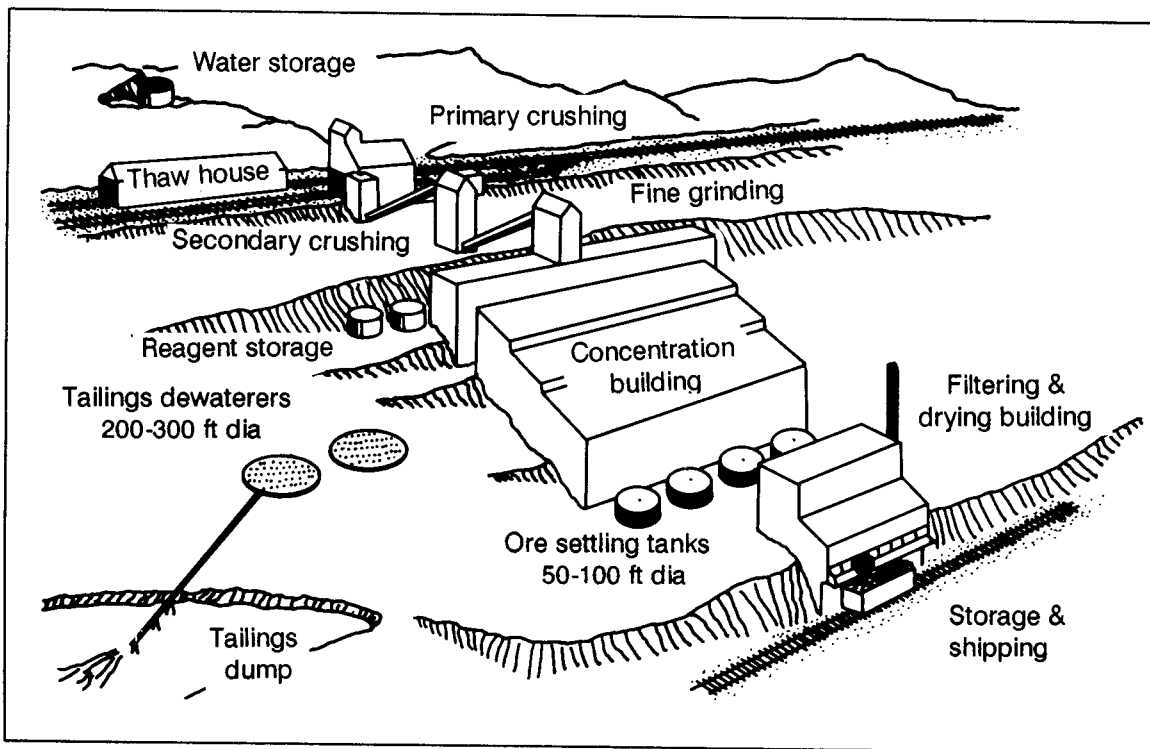


Figure 4-23. Example of construction/building type (ore processing - beneficiation)

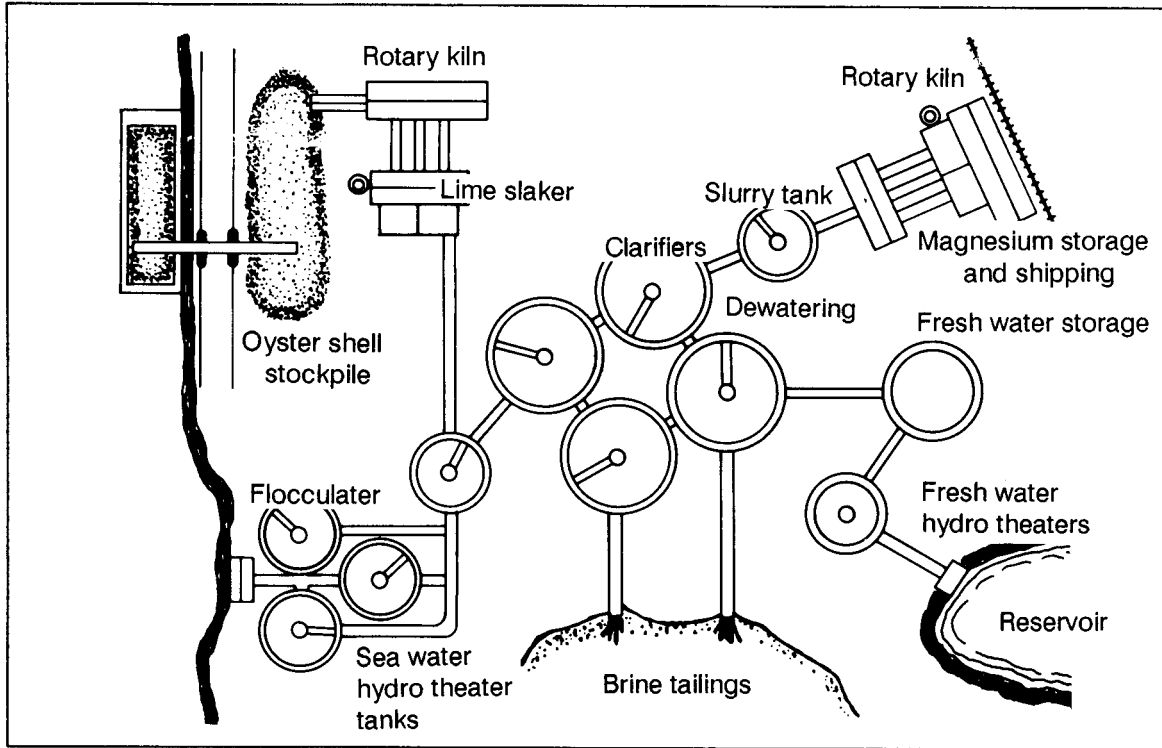


Figure 4-24. Example of construction/building (ore processing - magnesia from brines)

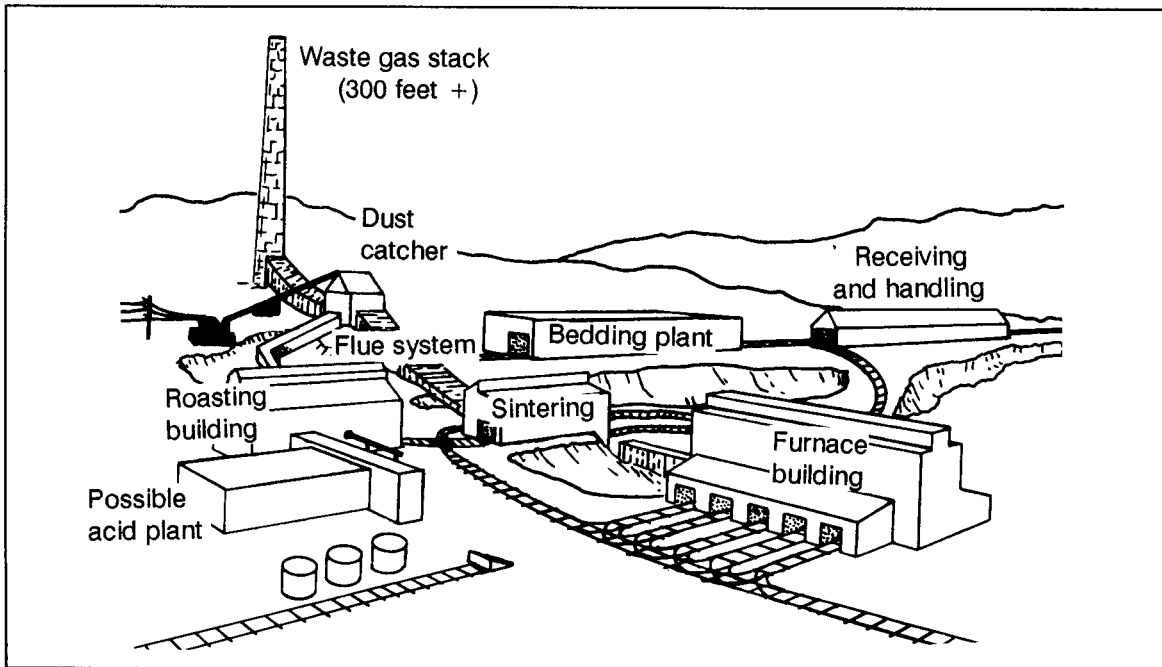


Figure 4-25. Example of construction/building (ore processing - reduction - classical smelter)

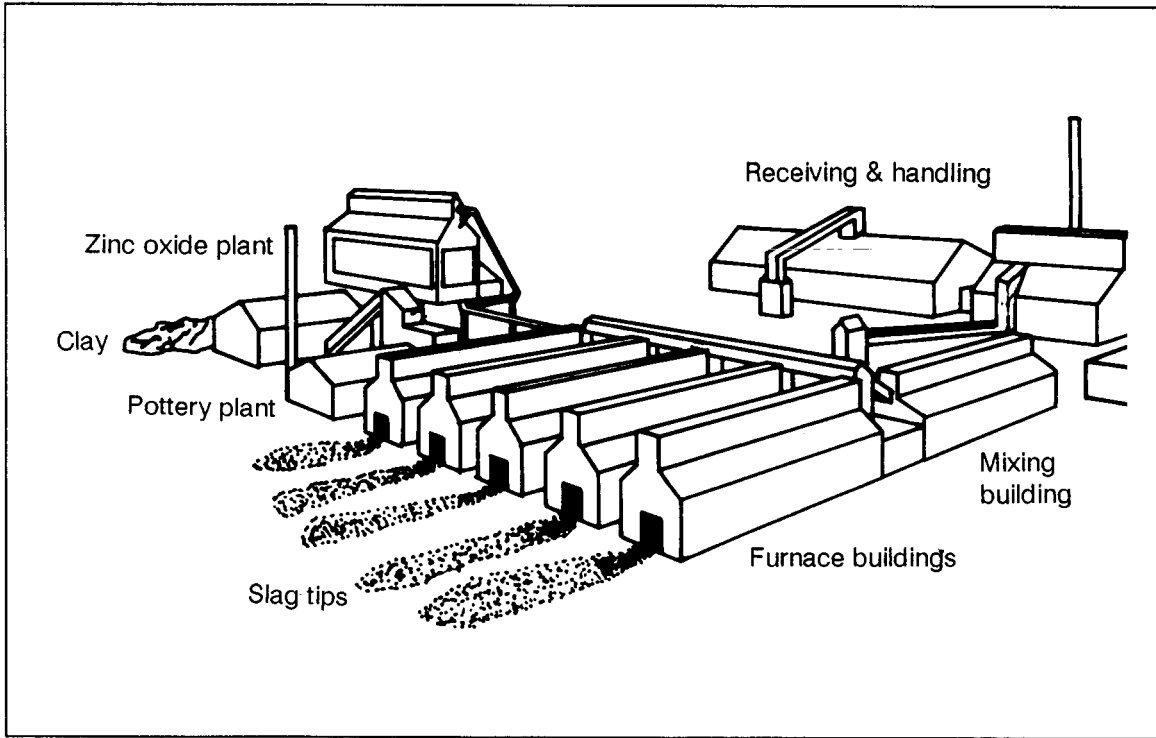


Figure 4-26. Example of construction/building (ore processing - reduction - horizontal retort smelter)

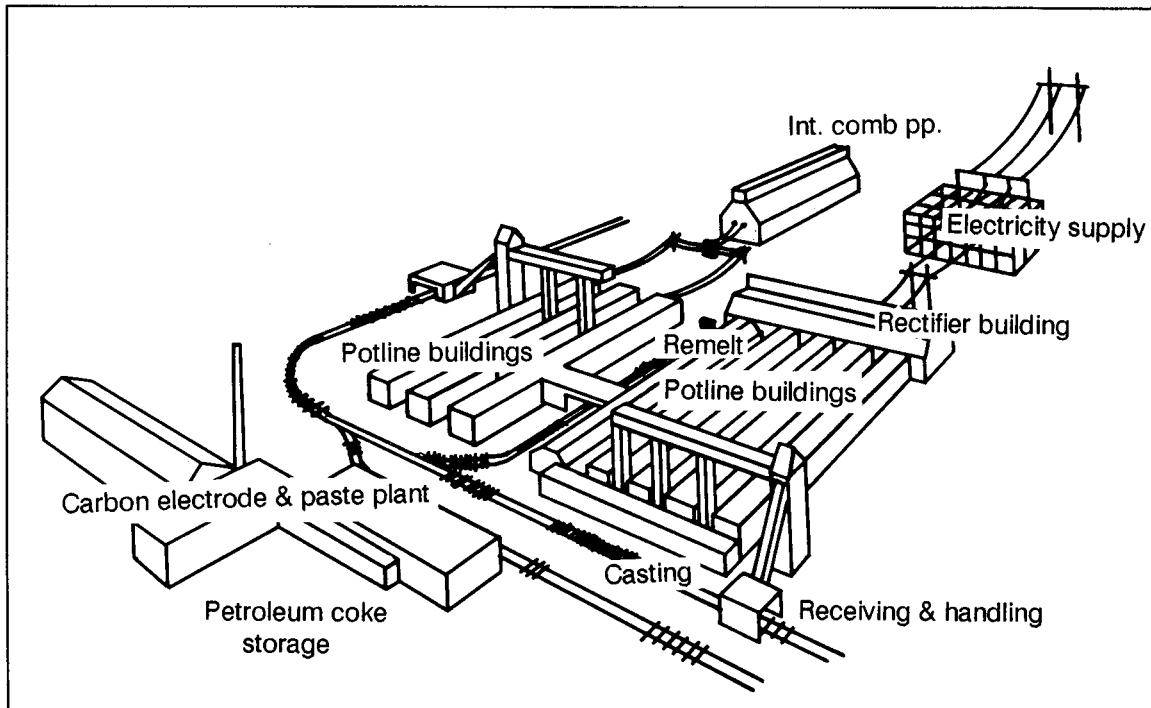


Figure 4-27. Example of construction/building (ore processing - reduction - horizontal retort smelter)

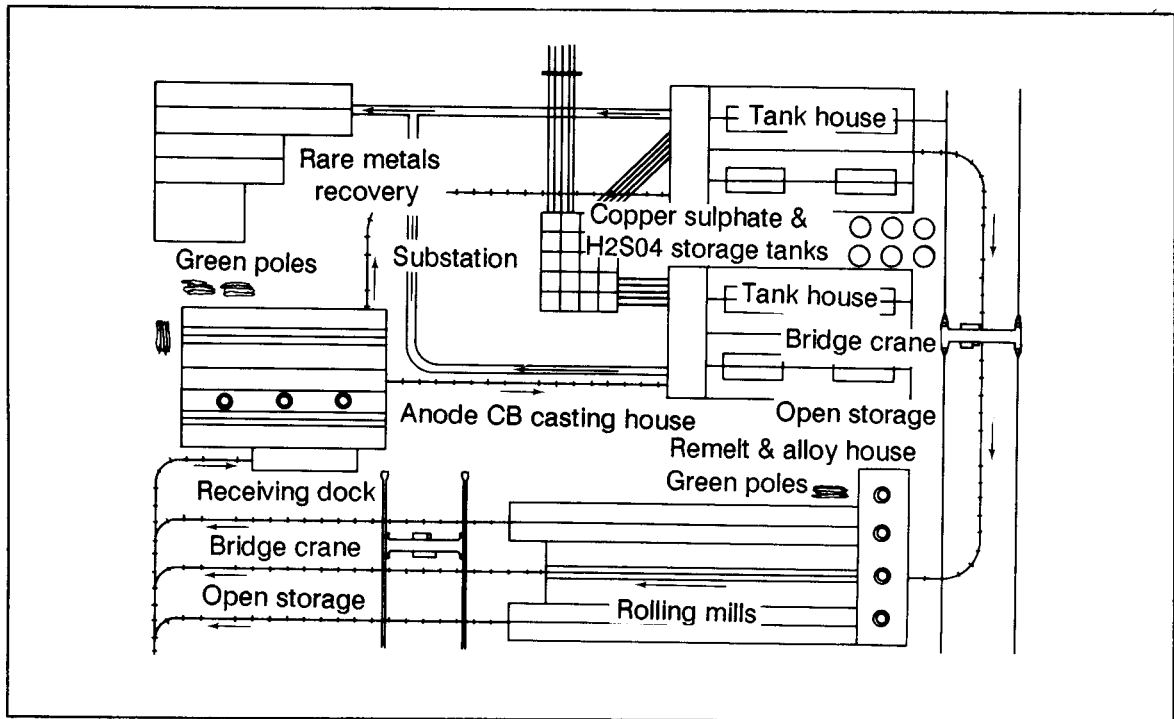


Figure 4-28. Example of construction/building type (electrolyte recovery)

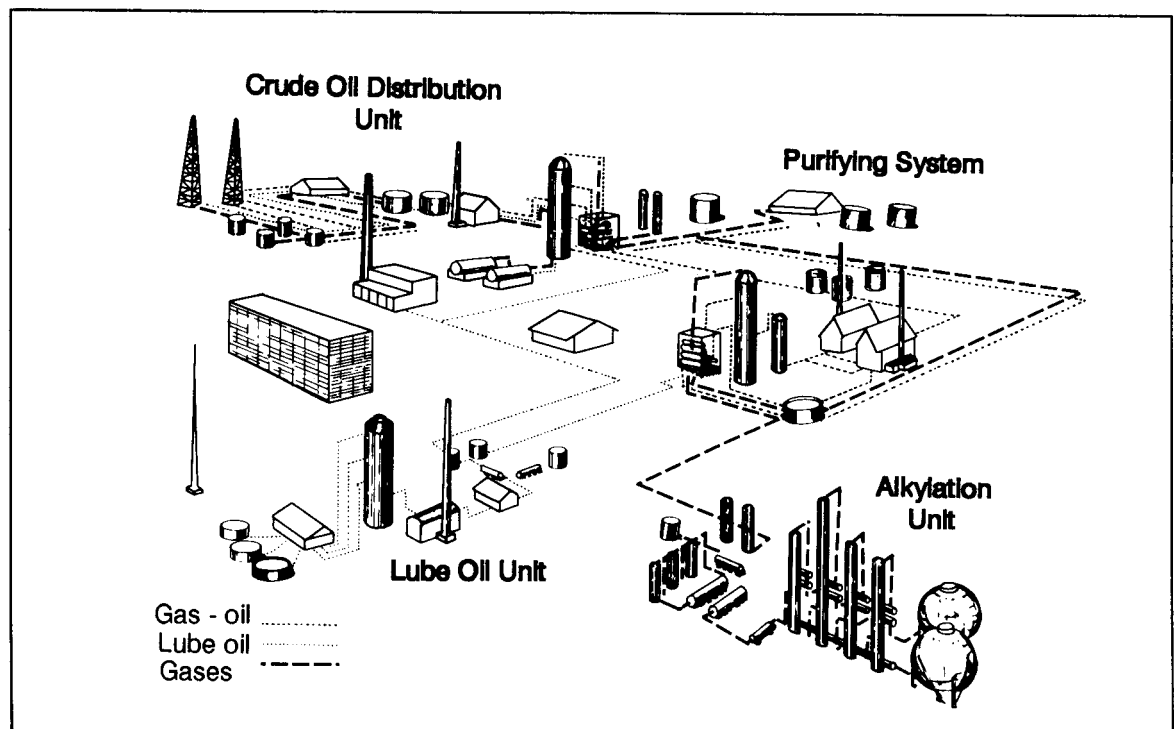


Figure 4-29. Example of construction/building type (master flowchart of the petroleum industry)

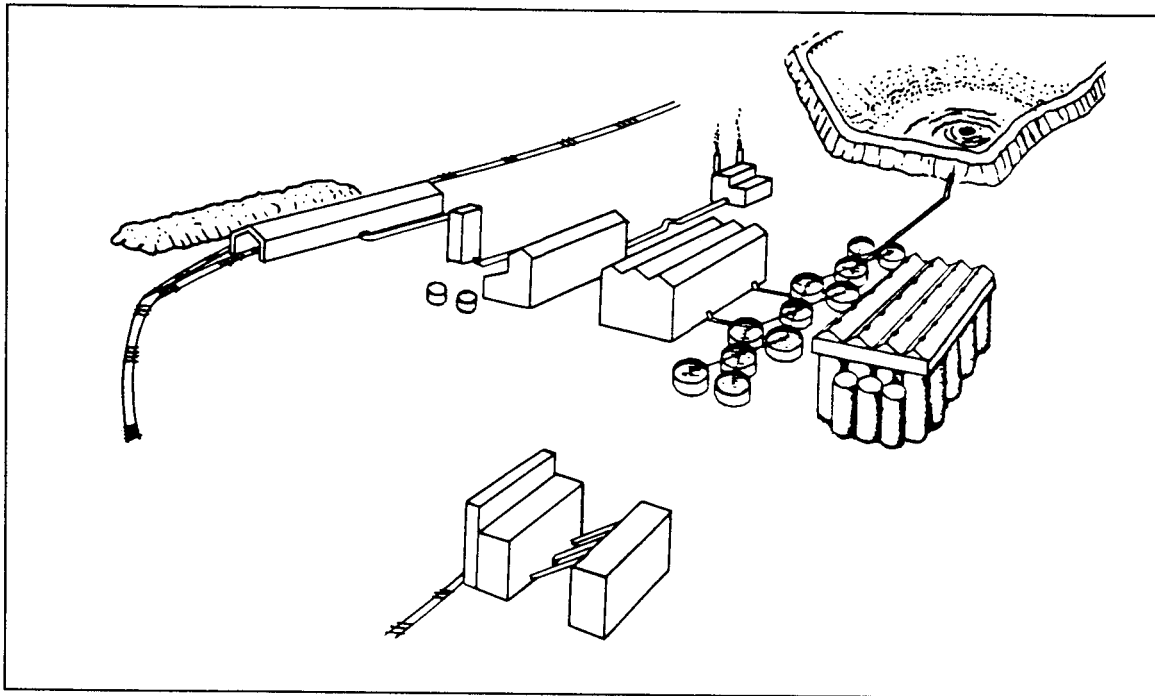


Figure 4-30. Example of construction/building type (ore processing - bayer alumina)

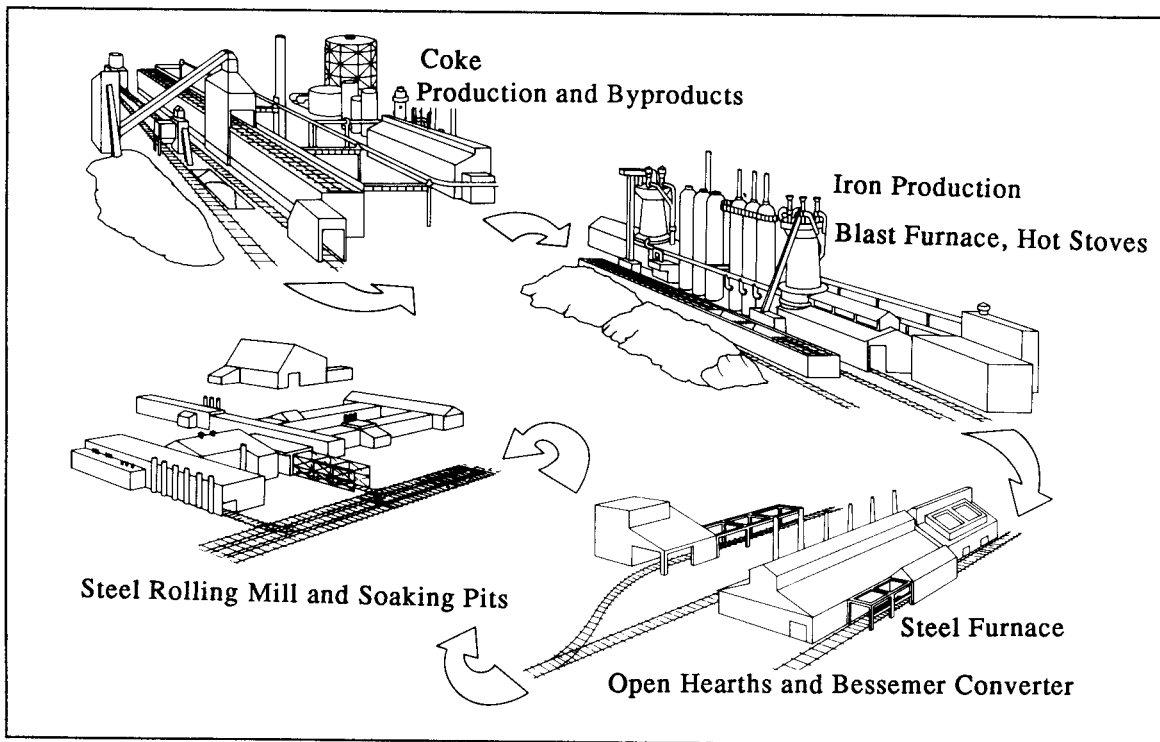
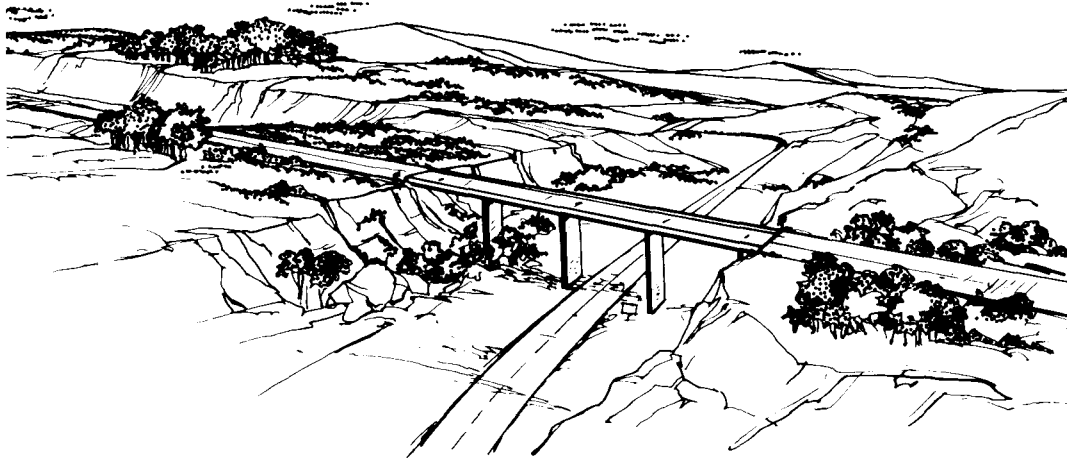


Figure 4-31. Example of construction/building type (integrated iron and steel plant)



LINES OF COMMUNICATION, COVER AND CONCEALMENT

Chapter 5

LINES OF COMMUNICATION

Lines of communication (LOC) are all the routes (land, water, and air) that connect an operating military force with a base of operations and along which supplies and reinforcements move. An LOC map is especially important to transportation corps and logistics personnel. It is also important for planning the interruption of enemy supplies. This map differs from the CCM map in that it shows routes over which supplies rather than deployed forces will move, so it depends more heavily on existing roads, railroads, and airfields.

Roads

Step 1. Study the requirements from corps and division before preparing specifications for synthesizing LOC roads.

Step 2. Examine the base map and become familiar with the LOC study area road net.

Step 3. Examine the transportation factor overlay, to select the major and secondary roads, the on-route fords, ferries, tunnels, galleries, and snowsheds for the LOC study. Identify major road categories to be used in the LOC study, such as all-weather hard surface and fair-weather loose surface.

Step 4. Examine the data tables to select the essential data elements listed on Table 1. See Figure 5-1.

Step 5. Obtain aerial photos for the area of interest to verify and update information.

ROADS	BRIDGES AND OVER-PASSES	**FORDS	**FERRIES	*TUNNELS, GALLERIES AND SNOW-SHEDS	AIRFIELDS	RAILROADS
Identification Number	*Length	Length	Crossing length	*Length and width	Identification	*Electrified
Category (highway, routes, autobahns, etc.)	*Width	Width	Vessel characteristics	Construction Details	*Runway orientation	*Abandoned
Segments	Load class construction type	Depth	Approaches	Overburden	Type	Routes
*Type	*Clearances	Bottom conditions	Load class	Clearances	*Surface material	*Yards/ terminals
*Width	*Bypass potential	Approaches			Parking facilities	Rolling stock
Surface materials and conditions					Hangars	Junctions/ crossings
Shoulders					POL	*Track(s)
Medians					Ammo/bomb storage	*Gage(s)
Obstacles					Quarters	Bridges
Culverts					*Elevation	
Cuts and fills					*Length/ width	
Turn-outs, emergency drive-offs and parking areas						
Level crossings						
Constrictions						
Grades						
Sharp curves						
Road or bridge under construction						
* Data elements deemed essential for LOC synthesis						
** Names and locations only						

Figure 5-1. Major data elements for LOC products

Step 6. Prepare an informal layup from alternate photos. Examine the road network, correlating the roads selected for the LOC study with the photos. Also examine the tunnels, galleries, snowsheds, ferries, and on-route fords.

Step 7. Stereoscopically examine the selected roads, tunnels, galleries, snowsheds, ferries and on-route fords to ensure that there are no changes or errors in the data-base parameter information. Revise and record any changes.

Step 8. Recheck all gathered information on roads, tunnels, galleries, snowsheds, ferries, and on-route fords to ensure that the selected roads meet with the user's request.

Step 9. Compile all pertinent data and draft it onto a clean overlay. Make sure the data pertains to the LOC, since not all data on factor overlays is necessary for an LOC overlay. See Figure 5-2.

See Figure 5-2 for typical roads and related structures found on a factor overlay. The data is derived from an analysis of maps, literature, and photos, and the details for the data elements are recorded on a roads factor overlay data table, which shows more than you need for a study. After examining the map area and identifying the LOC relevant data elements, check the available aerial photography of the area.

Bridges and Overpasses

Step 1. Study the requirements from corps and division before preparing specifications for synthesizing the LOC.

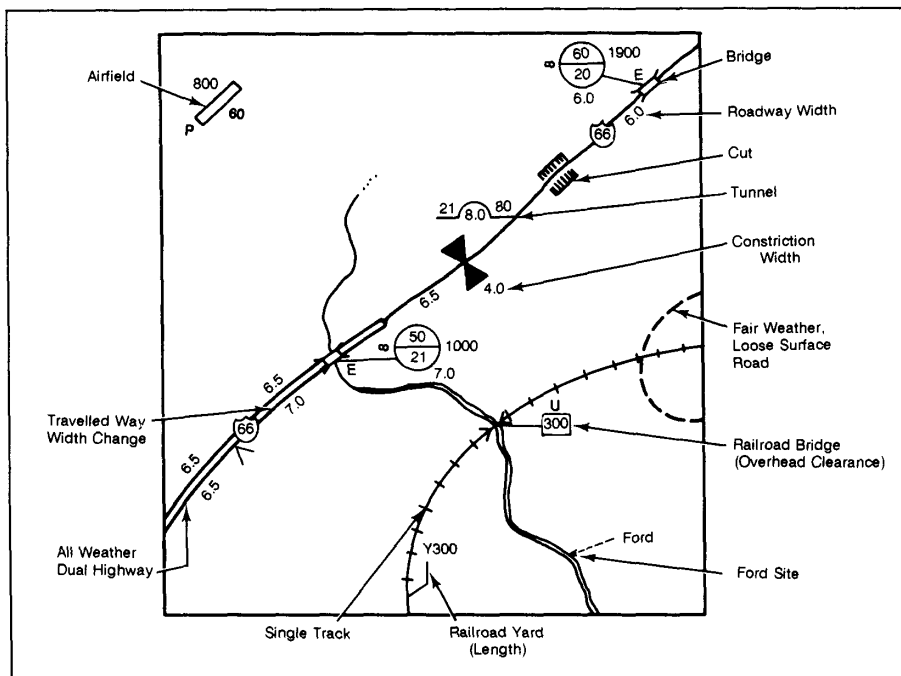


Figure 5-2. Sample annotated LOC overlay

Step 2. Examine the base topographic map to become familiar with the LOC study area.

Step 3. Examine the bridge section of the transportation factor overlay to select pertinent information.

Step 4. Examine the bridge data table to select the data elements listed on Table 1 for each relevant LOC.

Step 5. Obtain aerial photos for the area of interest to verify and update information.

Step 6. Prepare an informal layout from alternate photos. Examine the road network and locate the bridges selected for the LOC study area.

Step 7. Stereoscopically examine the selected bridges for any changes or errors in data-base parameter information. Revise and record any changes.

Step 8. Recheck all gathered bridge information to ensure the selected bridges meet with the user's request. You must show all bridges greater than or equal to 18 meters.

Step 9. Record only the pertinent information on the draft LOC. See Figure 5-2.

Railroads

Step 1. Study requirements from corps and division before preparing specifications for synthesizing the LOC railroads.

Step 2. Examine the base topographic map to become familiar with LOC study area railroads.

Step 3. Examine the transportation factor overlay to select LOC areas of interest.

Step 4. Examine the railroad data table to select the essential data element information as listed in Figure 5-3.

Step 5. Obtain aerial photos for the area of interest to verify and update information.

Step 6. Prepare an informal layout from alternate photos. Examine the area railroads and locate the segments selected for the LOC study area.

Step 7. Stereoscopically examine the selected railroads for any changes or errors in data-base parameter information and make necessary revisions.

Step 8. Recheck all gathered information to ensure that selected railroads meet with the user's request.

Step 9. Outline all information on the draft overlay.

PARAMETER	FACTOR	CRITERIA
Good	Slope	>30%
	Canopy closure	> 50%*
	C3 C4 D3	D4 E3 E4
	Roof Covered**	>40%
Fair	Slope	10-30%
	Canopy closure	<50%
Poor	C1 C2 D1	D2 E1 E2
	Roof Coverage**	20-40
	Slope	<10%
	Non-forested	A1 B G
	Roof coverage**	<20%
* Or stem spacing 5m		
** If evaluated		

Figure 5-3. Cover from flat trajectory weapons

Note : Criteria may not be applicable to your unit.

Airfields

Step 1. Study requirements from corps and division before preparing specifications for synthesizing the LOC airfields.

Step 2. Examine the base topographic map to become familiar with the LOC study area.

Step 3. Examine the transportation factor overlay to select pertinent areas of interest.

Step 4. Examine the airfield data table to select the essential data elements information as listed in Figure 5-3.

Step 5. Obtain aerial photos for the area of interest to verify and update information.

Step 6. Prepare an informal layout from alternate photos. Examine the airfields and locate the segments selected for the LOC study area.

Step 7. Stereoscopically examine the selected airfields for any changes or errors in data-base parameters' information, and make necessary revisions.

Step 8. Recheck all gathered information on airfields to ensure that selected airfields meet the user's request.

Step 9. Outline all information on the draft LOC overlay.

Remaining Factor Overlays

Step 1. Check the soils factor overlay to see what effect soil conditions will have on unsurfaced routes. Consider the probable weather to see if it might cause

surfaces to be muddy, frozen, dry, or dusty and to see if the expected condition will be favorable or unfavorable to movement along the roads.

Step 2. Check the vegetation factor overlay and mark any areas where vegetation will conceal the route. Show the percent of canopy closure at the given time of year.

Step 3. Check the drainage factor overlay to locate and mark areas where flooding might impede movement, to see if any rivers must be bridged or forded, and to see what trussing facilities exist. Figure 5-4 shows steps to be followed in the synthesis process from existing factor overlays and data tables.

COVER FROM FLAT TRAJECTORY WEAPON

Cover, or protection from enemy fire, is a vital part of military operations. Examples are rocks, river banks, vegetation, quarries, walls, and buildings.

Step 1. Study requirements from the requester.

Step 2. Obtain source materials, including the base topographic map, photography, and vegetation and slope-factor overlays.

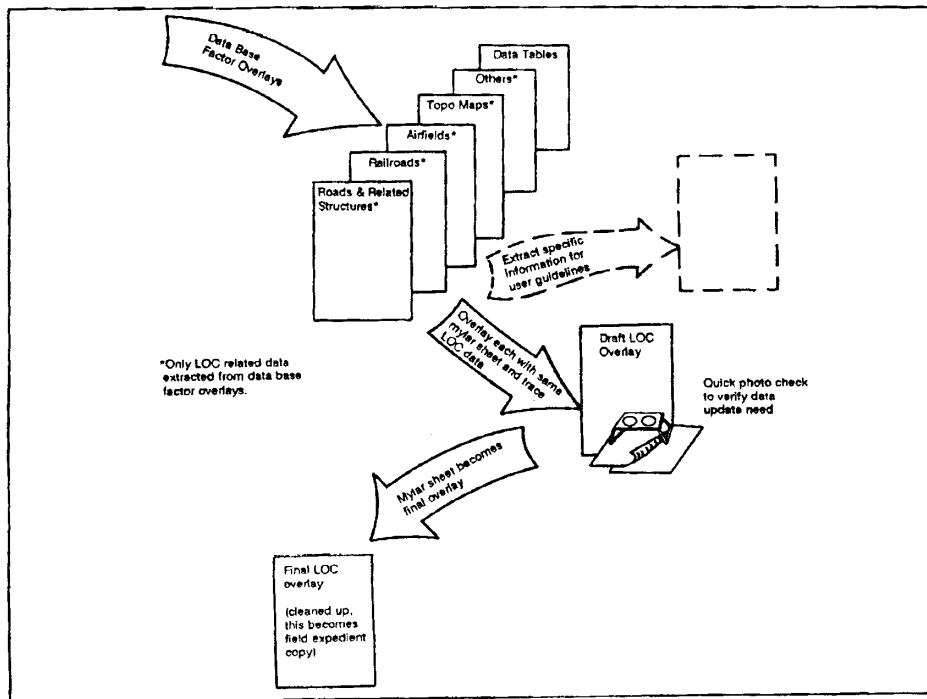


Figure 5-4. LOC synthesis process

PARAMETER	ROOF COVERAGE	VEGETATION CATEGORY		PERCENT CHANCE OF DETECTION
	Percent	Summer	Winter	
Best	>40%	C4, D4, E4, F4, I4	C4	0-25
Good	20-40	C3, D3, E3, F3, I3	C3	25-50
Fair	<20	B2, C2, E2, F2, I2, M	B2, C2, E3, E4	50-75
Poor		A1, B1, C1, D1, E1, F1, G1, G2, H, I1, J, K, L, N	A1, B1, C1, E1, E2, *D, *F, *G, H, J, K, L, N1, N2	75-100

* Or stem spacing 5m

Figure 5-5. Concealment from aerial detection summer or wet season

Step 3. Review source materials.

Step 4. Determine what parameters each category falls into (good, fair, or poor). To construct a cover overlay, you must consider slope, vegetation, and, roof coverage (if it is evaluated).

Step 5. Draft the cover overlay.

Note: This particular criteria being used may not be applicable to your unit. It should be revised to meet your units specific needs.

CONCEALMENT FROM AERIAL DETECTION

Concealment is protection from observation. This overlay is important for judging where the enemy might be located. It is especially important in areas where guerrilla forces might be operating, because it helps the commander predict attacks. Concealment may be provided by woods, underbrush, snowdrifts, tall grass, cultivated vegetation, roof coverage, or any other feature that denies observation.

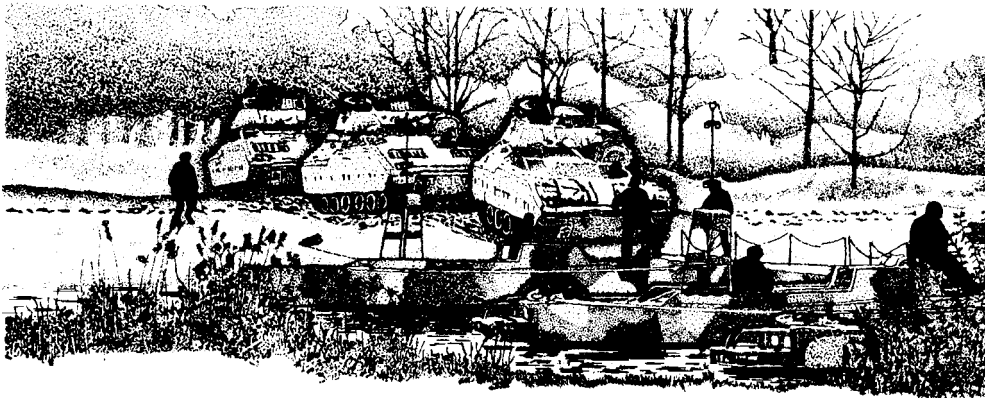
Step 1. Study the requirements and determine if concealment is for the summer (wet) season or for the winter (dry) season.

Step 2. Obtain the base map, aerial photography, and the proper seasonal vegetation factor overlay.

Step 3. Review the vegetation factor overlay with the base map and aerial photography to ensure that all vegetation categories are shown correctly. A deciduous forest with 25 to 50 percent canopy closure is a D2 vegetation code on the data-base factor overlay and is a fair area for concealment. A mixed forest with 0 to 25 percent canopy closure is an E1 vegetation code on the data-base factor overlay and is a poor area for concealment. The type of vegetation and the canopy closure are the two main factors you should check on the vegetation factor overlay.

Step 4. If evaluated, roof coverage is also used as protection from observation. You will probably look at this more in winter than summer because of the lack of vegetation during winter. Use Figure 5-5 to determine which parameter each vegetation category and roof coverage will fall into.

Step 5. Draft a concealment overlay.



CROSS-COUNTRY MOVEMENT

Chapter 6

PREPARE CCM OVERLAY

The cross-country movement (CCM) overlay is sometimes referred to as an avenue-of-approach map because it tells the best routes by which various vehicles can get to an objective when they cannot use prepared roads. It also shows parts of terrain that these vehicles cannot cross.

Step 1. Assemble source materials. These will include the base topographic map, aerial photography, slope (surface configuration), vegetation and soils (surface materials) factor overlays, and the following tables:

- Table 6-1, Vehicle characteristics.
- Table 6-2, Slope/speed characteristics.
- Table 6-3, Soils factor (dry and wet).

VEHICLE	M1	M60A1	M109	M113	M35A2	M151	T62	T72	M2	M3	M48 AVLB	M60 AVLB	MLRS
Maximum Road Speed (kph)	71	48	56	48	56	50	50	(60)	66	66	48	51	64
Maximum On-Road Gradability (°)	68.7	60	60	60	64	60	62	(62)	60	60	30	30	60
Maximum Off-Road Gradability (°)	53	45	45	45	30	28	(45)	(45)					
Vehicle Width (m)	3.65	3.63	3.10	2.69	2.43	1.69	3.37	3.38	6.2	6.2	4.3	4.3	2.97
Override Diameter at Breast Height (m)	.25	.15	(.12)	.10	.06	.04	(.15)	.18					
Vehicle Cone Index 1 Pass (VCI ₁)	25	20	25	17	26	19	21	(25)	15	15	26	22	
Vehicle Cone Index 50 Passes (VCI ₅₀)	58	48	57	40	59	44	49	(60)	35	35	60	51	
Minimum Turning Radius (m)	9.9	9.4	6.6	4.8	5.3	5.8	9.33	9.2	6.2	6.2	9.6	9.6	6.97
Vehicle Length (m)	9.9	9.4	6.6	4.8	6.7	3.35	9.33	9.2	6.2	6.2	9.6	9.6	6.97
Military Load Class	60	54	24	12	10	NA	42	45	24	24	62	63	28

Table 6-1. Vehicle characteristics

MAP UNIT	GROUND SLOPE (%)	F ₁	F ₂	F _{1/2}	NO GO
A	(0-3%) 1.5	34.80	1.00	34.80	
B	(3-10%) 6.5	30.80	.99	30.49	
C	(10-20%) 15	24.00	.98	23.52	
D	(20-30%) 25	16.00	.97	15.52	
E	(30-45%) 37.5	6.00	.96	5.76	
F	(45%)	---	---	----	XXX
G	N/A	---	---	5.76	
W	N/A	0	0	0	X

Table 6-2. Sope/speed characteristics

MAP	RCI _D	F4D	NO GO	RCI _W	F4W	NO GO
SP (063)	145	1		73	1	
SM (072)	119	1		25	.35	
SC (082)	126	1		46	1	
ML (091)	118	1		20	.13	
CL (101)	123	1		40	1	
OH (140)	107	1		1	0	XXX
	EXAMPLE	ONLY				
SM1	119					
SM2	72					
SM3	25					

Table 6-3. Soils factor (dry and wet)

- Table 6-4, Soils data.
- Table 6-5, Categories for speeds and CCM map units.

SOILS CATEGORY	TYPE	RCI VALUES		
		DRY	MOIST	WET
01 (GM)	Gravel or sandy gravel, well graded	163	123	83
02 (GP)	Gravel or sandy gravel, poorly graded	160	120	81
03 (GM)	Gravel, silty	120	76	32
04 (GC)	Gravel or sand gravel, clayed	130	91	52
05 (SM)	Sand, well graded	155	116	78
06 (SP)	Sand, poorly graded	145	109	73
07 (SM)	Sand, silty	119	72	25
08 (SC)	Sand, clayey	126	86	46
09 (ML)	Silts	118	69	20
10 (CL)	Clays	123	81	40
11 (OL)	Organic silts	111	57	3
12 (MH)	Inorganic elastic silts	114	61	8
13 (CH)	Fat clays	136	99	62
14 (OH)	Fat organic clays	107	54	1
15 (PT)	High organic soils or peat	106	52	0
20 (R)	Rock outcrops	165	165	165
30 (NE)	Not evaluated	-	-	-
W (W)	Open water	0	0	0

Table 6-4. Soils data

SPEEDS (kph)	BASIC DESCRIPTOR	CCM MAP UNIT
> 30	GO	1
>15 <=30	RESTRICTED	2
>5 <=15	SLOW	3
>1.5 <=5	VERY SLOW	4
<= 1.5	NO GO	5
---	NO GO (OPEN WATER)	6
---	NOT EVALUATED (Built up area)	7

Table 6-5. Categories for speeds and CCM map units

- Table 6-6, Vegetation factor data.
- Table 6-7, Speed Prediction tabulation sheet.

MAP UNIT	STEM DIAMETER (m)	STEM SPACING (m)	VEGETATION ROUGHNESS (VR)	SPACING FACTOR (V1)	OVERRIDE FACTOR (V2)	VEGETATION FACTOR (F3)	NO GO
C34	.15	2.6	1	0	0	0	XXX
C35	.20	3.7	1	.03	0	.03	
C45	.20	2.8	1	0	0	0	XXX
D13	.09	4.0	1	.06	.19	.19	
D24	.21	4.0	1	.05	0	.05	
E24	.185	4.0	1	0	0	0	XXX
E34	.175	2.6	1	0	0	0	XXX
EXAMPLE ONLY							
G1			.9			.9	

Table 6-6. Vegetation factor data

Step 2. Determine the vehicle to be used and whether the CCM product will be prepared for dry or wet conditions or both.

Step 3. Procure the surface configuration factor overlay and Tables 6-1 and 6-2.

Step 4. Compute the F1 speed/slope factor. This calculation determines the extent that any slope will deteriorate the speed of the vehicle without consideration for any other physical factor.

Using Table 6-1, determine the maximum off-road gradability (kph), maximum on-road gradability (%), and maximum road speed (kph). Record this information in the appropriate column of Table 6-2.

AREA	SURFACE CONFIGURATION/SIF		VEGETATION		SURFACE MATERIALS			SURFACE ROUGHNESS	SPEED (KPH)		CCM _D MAP UNIT	CCM _W MAP UNIT
	MAP UNIT	F _{1/2}	MAP UNIT	F ₃	MAP UNIT	F _{4D}	F _{4W}	F ₅	D	W		
1	B	30.49	D24	.05	SM2	1	.35	.9	1.37	.48	5	5
2	C	23.52	D24	.05	SM2	1	.35	.9	1.06	.37	5	5
3	C	23.52	D24	.05	CL1	1	1	1	1.18	1.18	5	5
4	B	30.49	D24	.05	CL1	1	1	1	1.52	1.52	4	4
5	A	34.80	D24	.05	CL1	1	1	1	1.74	1.74	4	4
6	B	30.49	D24	.05	CL1	1	1	1	1.52	1.52	4	4
7	B	30.49	D24	.05	ML1	1	.13	1	1.52	.20	4	5
8	C	23.52	D24	.05	ML1	1	.13	1	1.18	.15	5	5
9	B	30.49	D13	.19	CL1	1	1	1	5.79	5.79	3	3
10	B	30.49	D13	.19	ML1	1	.13	1	5.79	.75	3	5
11	C	23.52	D13	.19	ML1	1	.13	1	4.47	.58	4	5
12	A	34.80	D13	.19	ML1	1	.13	1	6.61	.86	3	5
13	A	34.80	D13	.19	CL1	1	1	1	6.61	6.61	3	3
14	D	15.52	C35	.03	SP3	1	1	.8	.38	.38	5	5
15	A	34.80	C35	.03	SP3	1	1	.8	.83	.83	5	5
16	A	34.80	C35	.03	SC2	1	1	.9	.94	.94	5	5
17	C	23.52	C35	.03	CL1	1	1	1	.71	.71	5	5
18	C	23.52	C35	.03	SP3	1	1	.8	.57	.57	5	5
19	B	30.49	C35	.03	SP3	1	1	.8	.73	.73	5	5
20	B	30.49	C35	.03	SC2	1	1	.9	.82	.82	5	5
21	A	34.80	D24	.05	SC2	1	1	.9	1.57	1.57	4	4
22	B	30.49	D24	.05	SP3	1	1	.8	1.22	1.22	5	5
23	B	30.49	D24	.05	SC2	1	1	.9	1.37	1.37	5	5
24	B	30.49	D24	.05	CL1	1	1	1	1.52	1.52	4	4
25	A	34.80	D24	.05	SC2	1	1	.9	1.57	1.57	4	4

Table 6-7. Speed prediction tabulation sheet

From the surface-configuration overlay, determine the percent of ground slope for slope categories A through F. Use the mid-point value of the slope category as ground slope, as shown below.

$$\text{Formula: mid-point} = \frac{\text{highest value} + \text{lowest value}}{2}$$

Example: Slope category = 10 to 20%

$$\text{Ground slope} = \frac{20 + 10}{2}$$

$$\text{Ground slope} = 30$$

$$\text{Ground slope} = 15\%$$

Record values of ground slope in the appropriate columns of Table 6-2.

Calculate F₁ values for each slope category.

$$\text{Formula: } F_1 = \frac{\text{maximum off-road gradability (\%)} - \text{ground slope (\%)}}{\text{maximum on-road gradability (\%)} \text{ maximum road speed kph}}$$

a. Negative values indicate No-Go areas, use F₁ = 0.

b. Round values to nearest hundredth, then post them on Table 6-2.

Note: Rounding is critical to the final value.

c. F₁ for map unit G (naturally or culturally dissected terrain) represents an unusual case and is best represented by using the lowest F₁ value obtained that still permits movement.

Example: Calculate the slope category for the M113 (see Table 6-1).

$$\begin{aligned} \text{Maximum off-road gradability} &= 45\% \\ \text{Maximum on-road gradability} &= 60\% \\ \text{Maximum road speed} &= 48 \text{ kph} \\ \text{Ground slope} &= 15\% \text{ (midpoint of 10-20\%)} \end{aligned}$$

$$F_1 = \frac{45 - 15}{60 - 48}$$

$$F_1 = \frac{45 - 15}{1.25}$$

$$F_1 = \frac{30}{1.25}$$

$$F_1 = 24.0 \text{ kph}$$

d. Record F₁ values on Table 6-2.

Step 5. Calculate F₂, slope-intercept-frequency (SIF) factor. SIF is the number of times the ground surface changes between positive and negative slopes over a one-kilometer distance. Measuring this is extremely time-consuming in the field, so use the expedient method.

a. Register the surface-configuration overlay to the appropriate topographic map. In a slope category on the overlay, lay a line equal to the length of a diagonal of a one-kilometer square (approximately 1.4 times the length of 1 kilometer on the map).

b. Count the number of times any contour line within the slope category crosses or touches the diagonal.

c. Lay out a second line at right angles and count intercepts as before.

Note: A prepared template will greatly speed this operation.

d. Repeat this procedure at least ten times for each slope map unit, then average the counts. See Figure 6-1.

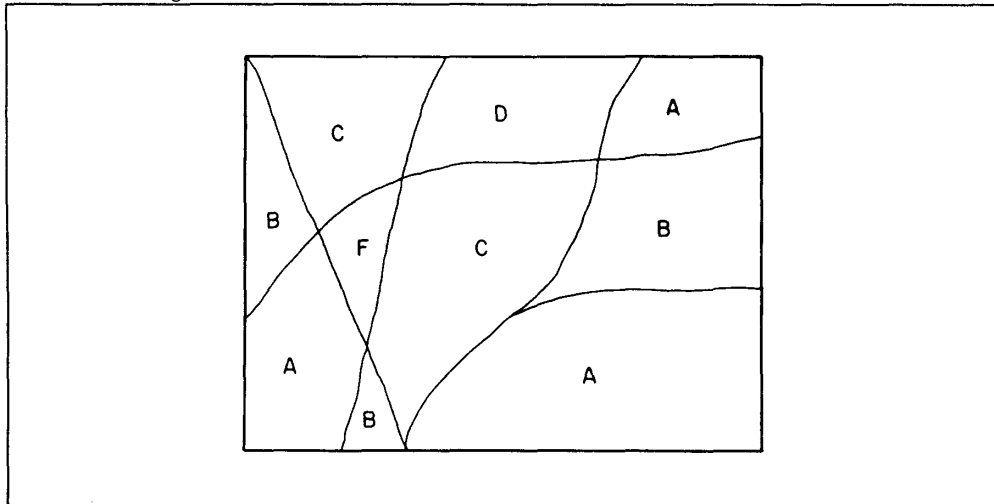


Figure 6-1. Surface configuration (slope)

e. Repeat this procedure for all slope categories A through F.

f. Adjust the average counts to the standard 1:50,000-scale map with a 20-meter contour interval.

1) Determine the adjusted count, using the formula--

$$\text{adjusted count} = \frac{\text{average count} \times \text{contour interval map used}}{\text{standard contour interval}}$$

Example:

Contour interval of map used = 10 m

$$\begin{aligned}
 \text{Average SIP count} &= 24.4 \\
 \text{Standard contour interval} &= 20 \text{ m} \\
 \text{Adjusted count} &= \frac{24.4 \times 10}{20} \\
 &= \frac{24.4}{2} \\
 &= 12.2 \text{ (Round to 12 or the nearest} \\
 &\quad \text{whole number).}
 \end{aligned}$$

2) Compute F_2 values for each slope category, using the formula--

$$F_2 = \frac{280 - \text{SIF count (adjusted)}}{280}$$

Example: SIP = 12

$$F_2 = \frac{280 - 12}{280}$$

$$F_2 = \frac{268}{280}$$

$$F_2 = .96$$

3) Round values to the nearest hundredth, and record them on Table 6-2.

4) Record the lowest F_2 value on map unit G.

Step 6. Calculate F , slope/SIF - speed calculation. This calculation gives the calculated speed based on the effects and variation of slope.

a. Compute F values using the formula

$$F = F_1 \times F_2.$$

Example: $F_{1/2} = F_1 \times F_2$

$$F_{1/2} = 24.0 \text{ kph} \times .96$$

$$F_{1/2} = 23.04 \text{ kph}$$

b. Record F in the appropriate column of Table 6-2.

Note: The value F will tell you what effect slope will have on vehicle speed.

Step 7. Obtain F_3 vegetation factor.

a. Procure the vegetation-factor overlay and vegetation-roughness tables, Tables 1 and 6. Continuing with the previously selected vehicle, compute the F_3 vegetation factor.

b. Using Table 6-1, determine the vehicle width in meters (m), maximum override diameter (m), and minimum turning radius (m) and record them on Table 6-6.

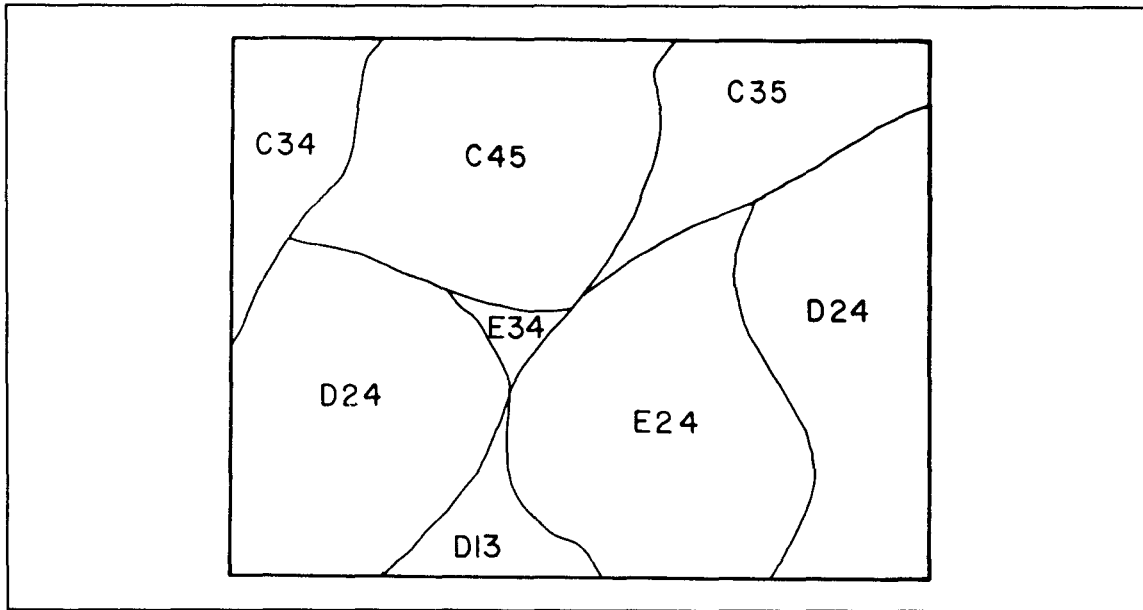



Figure 6-2. Vegetation

c. From the vegetation factor overlay, determine the forest types and list them in alphanumerical sequence on Table 6-6. List all other vegetation after the forest types. See Figure 6-2.

d. From the vegetation roughness table on the vegetation-factor overlay, determine the stem diameter (m), stem spacings (m), and vegetation-roughness factor for the appropriate forest types and record the information on Figure 6-6. See Figure 6-3. 

CODE	FOREST TYPE AND CANOPY CLOSURE														F1	F2	F3	F4
	C1	C2	C3	C4	D1	D2	D3	D4	E1	E2	E3	E4						
1	1	1	1	1	7	7	7	7	.85	.85	.85	.85						
	2.5	2	1.5	1	2.5	2	1.2	8	2.5	2	1.3	.9						
2	6	6	6	6	4	4	4	4	5	5	5	5						
	2.5	2	1.5	1	2.5	2	1.5	1	2.5	2.0	1.5	1.0						
3	11	11	10	10	9	9	8	8	10	10	9	9			22			
	3.8	2.8	1.8	1.3	4.0	3.0	2.0	1.5	3.9	2.9	1.9	1.4	7.0					
4	16	16	15	15	22	21	20	19	19	18.5	17.5	17						
	6.0	6.0	2.6	2.2	7.0	4.0	2.5	2	6.5	4.0	2.6	2.1						
5	21	21	20	20	27	26	25	24	24	23.5	22.5	22						
	8.0	5.5	3.7	2.8	9.0	6.0	4.0	2.5	8.5	4.8	3.9	2.7						
6	27	27	26	26	34	34	32	30	30.5	30.5	29	28						
	11.0	7.0	4.7	3.2	12.0	7.0	5.0	3.5	11.5	7.0	4.8	3.4						
7	34	34	33	33	40	39	38	37	37	36.5	35.5	35						
	14	7.5	5.0	3.6	15.0	8.0	5.5	4.5	14.5	7.8	5.3	4.1						
8									41									
									5.0									
9									1									

Figure 6-3. Stem diameter(cm)-tree spacing(m)-vegetation roughness

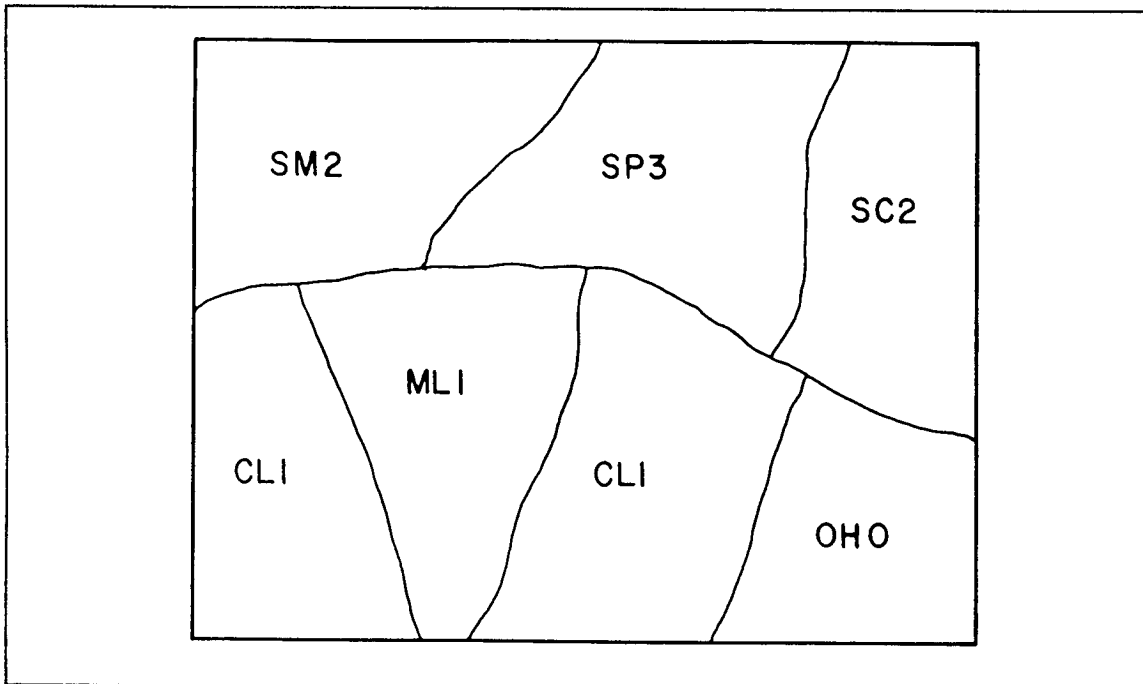


Figure 6-4. Soils

e. For nonforest types, place the vegetation roughness factor in the appropriate location on Table 6-2. For all forested areas, calculate V_1 and record it on Table 6-6. V_1 is the product of the vehicle factor (VF) and the vehicle clearance factor (V_{1a}). VF accounts for the response of drivers when approaching wooded areas. V_{1a} accounts for the physical ability of a vehicle to maneuver between tree stems in a wooded area.

Formula:

$$V_1 = (VF)(V_{1a})$$

Where--

$$VF = \frac{SS - SD - W}{W}$$

$$V_{1a} = \frac{SS - SD - W}{MTR - 4W}$$

SS = Stem Spacing (m)

SD = Stem Diameter (m)

W = Vehicle Width (m)

MTR = Minimum turning radius (m)

Notes:

1. if VF or $V_{1a} \leq 0$, $V_{1a} = 0$
2. if $VF \leq 1$, $VF = 1$
3. if $V_{1a} \leq 1$, $V_{1a} = 1$.

f. Calculate V_2 for all forested areas and record it on Table 6-6. V_2 is the calculation used to determine if it would be easier for the vehicle to override the trees rather than maneuver between them. The VT portion of the formula is used to calculate the minimum number of trees a vehicle can hit at one time.

Formula:

$$V_2 = 1 - \left(\frac{VT(SD^2)}{OD^2} \right)$$

$$VT = \frac{W + SD}{SS}$$

Notes:

1. if $SD > OD$, $V_2 = 0$.
2. if $V_2 \leq 0$, $V_2 = 0$.
3. if $VT \leq 1$, $VT = 1$.

g. Calculate F_3 = Select the larger value between V_1 and V_2 .

Formula: $F_3 = (VR)(V_1 \text{ or } V_2)$
 VR = vegetation roughness factor (obtain from the vegetation overlay)

Notes:

1. If $F_3 > 1.0$, $F_3 = 1.0$
2. If $F_3 > 0$, $F_3 = 0$ (No-Go)

h. Record F_3 values on Table 6-5.

Step 8. Procure the soil factor overlay and Tables 1, 3, and 4. Continuing with the previously selected vehicle, compute the F_4 soil factor. This calculation will determine if a particular soil type will support vehicular movement and to what extent the speed will decrease due to that soil type. See Figure 6-4.

a. Using Table 6-1, determine the vehicle cone index (VCI_1) for one pass and the vehicle cone index (VCI_{50}) for fifty passes. Record them on Table 6-3.

b. From the surface-materials factor overlay, extract the appropriate soils map units, such as ML1, SM2, and OH0, and post them on Table 6-3.

Note: The third digit refers to the surface-roughness code.

c. From Tables 6-1 and 6-4, determine appropriate RCI values for dry and/or wet conditions and post them on Table 6-3.

d. Calculate the dry-soil factor (F_{4D}) and/or wet-soil factor (F_{4W}) for each soil type.

$$\text{Formula: } F_{4D} = \frac{RCI_D - VCI_1}{CI_{50} - VCI_1}$$

$$F_{4W} = \frac{RCI_W - VCI_1}{VCI_{50} - VCI_1}$$

Notes:

1. if $F_4 \leq 0$, $F_4 = 0$ (No Go)
2. if $F_4 \geq 1$, $F_4 = 1$

e. Record F_4 values on Table 6-4.

CONSTRUCT COMPLEX FACTOR OVERLAY

Step 1. Register the overlay to the base map.

Step 2. Outline the built-up areas (color in red).

Step 3. Outline the open-water areas (color in blue).

Step 4. Using the surface-configuration overlay and the vegetation-factor data table, register complex overlay to the factor overlay and outline the slope areas (color No-Go areas in yellow).

Step 5. Using the vegetation factor overlays and Table 6-3, vegetation factor data, register the complex overlay and outline the vegetation areas (do not draw lines through areas already colored). Color No-Go areas in yellow, and disregard areas less than 250 x 250 meters at map scale (5mm for 1:50,000) or narrow areas less than 100 meters in width at map scale (2mm for 1,50:000).

Step 6. Using surface-materials factor overlay and Table 6-4, soil factor (dry and wet data), follow the procedures in Step 5.

Step 7. Beginning in the upper left corner, number the noncolored areas from 1 through 99. If you have more than 99 areas, outline the first area of 99 and label it as Sector A. Number remaining areas 1 through 99, as before, and label them as Section B. Continue numbering areas and sectors as required.

Step 8. Annotate all sector and area numbers on Table 6-5.

Step 9. Compute CCM speed.

a. Using the completed complex factor overlay and the surface-configuration factor overlay, determine the appropriate map unit for each area and post it on Table 6-5.

b. Determine the $F_{1/2}$ value for the map units from Table 6-2 and post it on Table 6-5.

c. Using the complex factor overlay, the vegetation overlay, and Table 6-3, determine the map units and F_3 values and post them on Table 6-5.

d. Using the complex factor overlay, the surface materials overlay and Table 6-4, determine the map units and F4 values and post them on Table 6-5.

e. Determine the surface roughness factor (F5) for each area from the surface materials overlay and post it on Table 6-5. See Figure 6-5.

<u>SOIL TYPE</u>	
<u>MAP UNIT (1ST TWO DIGITS)</u>	<u>DESCRIPTION</u>
GW	Well-graded gravels, gravel-sand mixtures, little or no fines.
GP	Poorly graded gravels or gravel-sand mixtures, little or no fines.
GM	Silty gravels, gravel-sand-silt mixtures.
GC	Clayey gravels, gravel-sand-clay mixtures.
SW	Well-graded sand, gravelly sands, little or no fines.
SP	Poorly graded sands or gravelly sands, little or no fines.
SM	Silty sands, sand-silt mixtures.
SC	Clayey sands, sand-clay mixtures
ML	Inorganic silts and very fine sands, rock flour, silty or clayey fine sands or clayey silts with slight plasticity.
CL	Inorganic clays of low to medium plasticity, gravelly clays, sandy clays, silty clays, lean clays.
OL	Organic silts and organic silty clays of low plasticity.
MH	Inorganic silts, micaceous or diatomaceous fine sandy or silty soils, elastic silts.
CH	Inorganic clays of high plasticity, fat clays.
OH	Organic clays of medium to high plasticity, organic silts.
PT	Peat and other highly organic soils.
RK	Rock outcrops.
EV	Evaporites.
X	Not evaluated.
PS	Permanent snowfields.
W	Open water.

Figure 6-5. Surface materials legend

<u>SURFACE ROUGHNESS</u>		<u>ESTIMATED SURFACE ROUGHNESS FACTORS *</u>				
<u>MAP UNIT (3RD DIGIT)</u>	<u>DESCRIPTION</u>	<u>MEDIUM & LARGE TANKS</u>	<u>LARGE WHEELED VEHICLES</u>	<u>SMALL WHEELED VEHICLES</u>	<u>SMALL TRACKED VEHICLES</u>	<u>FOOT TROOPS</u>
0	No Data	—	—	—	—	—
1	No surface roughness effect	1.00	1.00	1.00	1.00	1.00
2	Area of high landslide potential	.00	.00	.00	.00	.00
3	Stony soil with scattered surface rock	.90	.90	.80	.85	.95
4	Quarry	.05	.05	.05	.05	.75

* Surface roughness factors are indicated with 0.00 having maximum and 1.00 having least impact on CCM.

SOIL DEPTHS
 _____ < .5 meters

SOIL MOISTURE
 Soil normally moist
 Soil normally wet

Example: Map unit SC3 = Clayey sands, sand-clay mixtures, stony with scattered surface rock, normally moist, depth <.5 meters

Figure 6-5 continued. Surface materials legend

f. Calculate the final CCM dry and/or wet speeds for each area. Use Table 6-7 and the following formula:

$$\text{Speed (kph)} = F1/2 \times F3 \times F4W \times F5$$

Note: Round all interim and final calculations to the nearest hundredth. Post them on Table 6-5.

g. Determine the CCM dry and/or wet map unit for each area using the CCM legend, and post it on Table 6-5.

h. Combining areas of like CCM map units, draw the CCM product in final format.

i. Add the appropriate linear obstacle data.

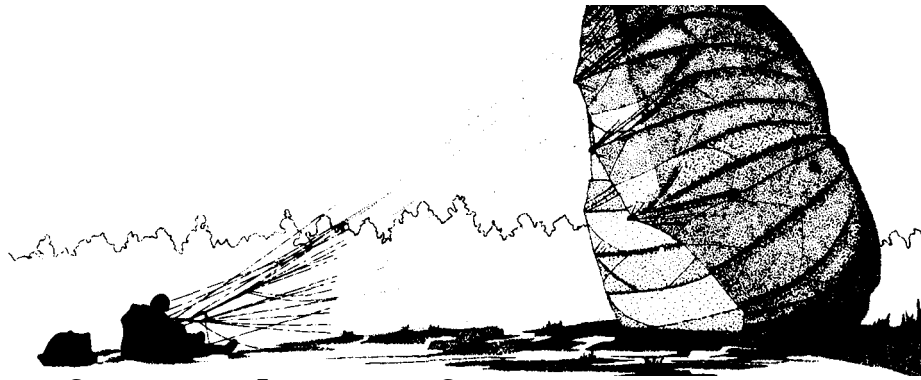
PERFORM AVENUE OF APPROACH SYNTHESIS PROCEDURE

An avenue of approach is a route that must offer some ease of movement plus provide for an adequate dispersion of a friendly or enemy force large enough to have a significant impact on a military operation. The avenue of approach product does not include the status or possible actions of an enemy force. The end results are avenues of approach suitable for friendly force configurations capable of successfully completing the mission.

Step 1. Combine and analyze previously completed terrain products such as the CCM, transportation (LOC), and linear obstacle overlays and updated aerial photography of the area of operations to produce mobility corridors.

Step 2. Incorporate the limitations imposed by the battlefield terrain on friendly and enemy doctrine.

Step 3. Forward the data gathered in Steps 1 and 2 to G2 or S2 military intelligence (MI) personnel to identify the terrain influence on the configuration of friendly and enemy forces in the area of operations. MI personnel will evaluate mobility corridors using the doctrinal template, which considers battle doctrine, the tactical situation, and possible high-value targets.



Line of Site and Zone of Entry

Chapter 7

LINE OF SITE

The line of site (LOS) is an unobstructed view from point A to point B. Requests for LOS products are becoming more frequent just as the effective ranges of our weapons, radar, and communications equipment are increasing. We can only realize the effectiveness of long-range weapons with ranges of over 4,000 meters and of current corps and division communications equipment with ranges of 50 to 60 kilometers if the equipment is emplaced properly in areas containing equivalent-distance LOSs or groups of LOSs (as in fields of fire).

The seven methods for determining LOS are--

- Ground truth (occupy positions), which is the most reliable, least likely, and least convenient method.
- Elevation layer tints, which do not consider refraction or the curvature of the earth.
- Survey intervisibility formula, which adds constants for curvature of the earth and refraction but does not consider vegetation height.
- Analytical Photogrammetric Positioning System (APPS), which is only as good as equipment accessibility, operator training, and data-base accuracy.
- Profile (topographic map) method is the old, faithful method, almost universally known, but which does not consider refraction or curvature of the earth.
- Aerial photography (the floating line method), which is better used for short distances.
- MICROFIX, which is accurate, dependent on access to digital terrain elevation data (DTED), and useful for a wide variety of product.

As a terrain analyst, you must often determine if one location can be seen from another location or if terrain is blocking the view. Intervisibility is the ability to see from one object or station to another and is important to determine LOS. It can

be a tactical means of identifying defiladed areas for maneuver units or effects of direct fire on ground forces. The best way to determine intervisibility is to physically occupy each station. Since you cannot always be in the physical area, however, you must use topographic maps and aerial photographs. You must be able to plot coordinates on stereo-paired photos and construct a profile of a topographic-map area.

Topographic Map Method

Make sure you have your photo interpretation kit. It contains a photo plot, your remote-sensed imagery (RSI), straightedge, pin vise and pin, point designation grid (PDG) template, and a mission directive that contains location instructions.

Step 1. Look at your mission directive to obtain information about the location you will profile. The directive will also tell you which points to plot on the map. Use the UTM coordinates on the map to plot the two points.

Step 2. Draw a line across the area to be profiled connecting the two points you have just plotted. This is the profile line. Figure 7-1 shows an example.

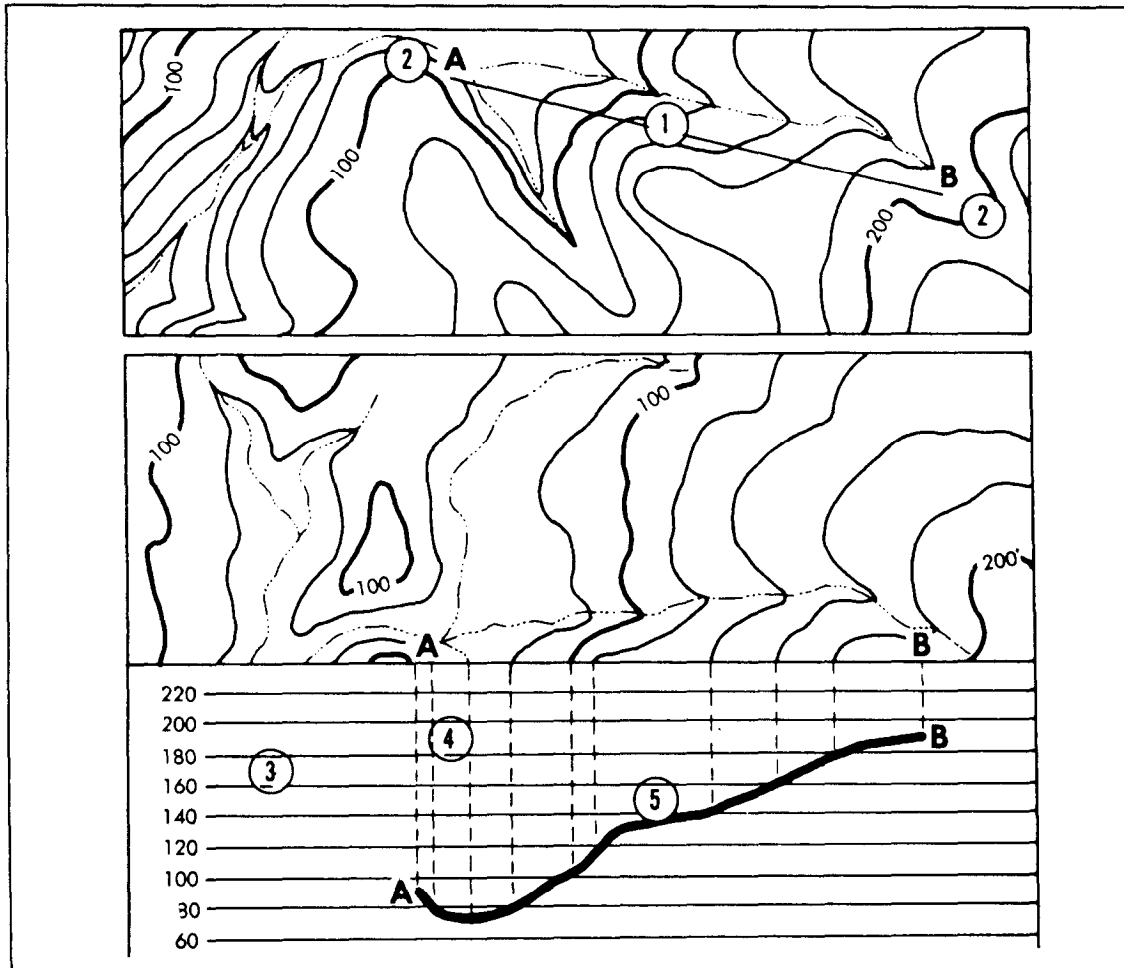


Figure 7-1. Topographic map example

Step 3. Increase the value of the highest contour line. This will become the upper-line measurement on the numbered profile lines. Start by looking at the map and identifying the highest contour line that either crosses or touches the profile line you have just drawn. Next, look at the bottom of your map and identify the contour interval; for example, it may say “contour interval 20 meters.” Increase the highest contour line by the contour interval. For example:

$$\begin{aligned}\text{Highest contour line} &= 200 \text{ meters} \\ \text{Contour interval} &= 20 \text{ meters} \\ 200 + 20 &= 220 \text{ meters}\end{aligned}$$

Step 4. Decrease the value of the lowest contour line that touches or crosses the profile line. This will become the lowest line measurement on the numbered profile lines. Again, use the contour interval from the map. Decrease the lowest contour line by the contour interval. For example:

$$\begin{aligned}\text{Lowest contour line} &= 80 \text{ meters} \\ \text{Contour interval} &= 20 \text{ meters} \\ 80 - 20 &= 60 \text{ meters}\end{aligned}$$

Step 5. Prepare a profile. A profile is a side view of terrain along a line between two points. On a blank sheet of paper, draw a straight line the same length as the profile line paper. Each line represents a contour value line that crosses or touches the parallel line. The highest elevation is at the top, the lowest is at the bottom. Draw two additional lines at the top and bottom so that one line is above the highest elevation and the other is below the lowest elevation. Number all lines to the right or left in sequence, with the highest value at the top. The dotted lines at 220 and 60 are the two added lines.

Next, place your lined sheet of paper against the profile line on the map. Extend dotted, vertical (perpendicular) lines from every point on the profile line to the corresponding value line. Place a tick mark where each perpendicular line crosses the profile line. This will ensure the contour value for each profile below a map. Look at the perpendicular extensions from the contour lines to the corresponding value line.

Step 6. Interpolate hill and valley lines. Interpolation is a method of determining the highest elevation of a hill and the lowest point of a valley. Since they are either higher or lower than the known elevations, determine them separately. On the profile, insert the interpolated lines between the other contour-value lines.

To estimate the height of a hill using the interpolation method, add half the contour interval to the known elevation. For example:

$$\begin{aligned}\text{Known elevation} &= 200 \text{ meters} \\ \text{Contour interval} &= 20 \text{ meters} \\ 1/2 \text{ Contour interval} &= 10 \text{ meters} \\ 200 + 10 &= 210 \text{ meters} \\ \text{Interpolated value} &= 210 \text{ meters}\end{aligned}$$

To estimate the bottom of a valley using the interpolation method, subtract half the contour interval from the known elevation. For example:

Known elevation = 80 meters
Contour interval = 20 meters
1/2 Contour interval = 10 meters
80 - 10 = 70 meters
Interpolated value = 70 meters

Step 7. Draw interpolated perpendicular lines extending to the corresponding value lines. Notice how close they are to the highest and lowest elevation lines.

Step 8. Draw a dark line connecting the perpendicular lines. Smooth, natural lines represent hills and valleys. V- or U-shaped lines represent streams. Figure 7-1 illustrates a completed profile.

Aerial Photography Method

Step 1. Orient the aerial photos for stereo viewing. Ensure that shadows of features such as bridges, riverbanks, and low buildings appear to fall toward you, the viewer.

Step 2. Locate the PDG coordinates on each photo. PDG coordinates provide a means of locating (plotting) points that represent features, targets, and positions on an aerial photograph. Look in your mission directive to identify the PDG coordinates of two points for each photograph. Place a grid over each photo, beginning with the left one, and locate the grid square containing the point you will plot. Using the standard "read right and up," plot each point according to its PDG coordinates. Use the standard map scale of 1:25,000, so you can use a map protractor for plotting. Plot the points in order of the first point on the left photo, first point on the right photo, second point on the left photo, and second point on the right photo. Finally, enter the coordinates in the marginal information area on each photo.

Step 3. Pinprick the points on the photos, in the same order as in step 2.

Step 4. Draw a connecting line between the points you have pin pricked and connect points 1 and 3 on the left photograph. Next, connect points 2 and 4 on the right photo. At this time, take a moment to check your work to make sure it is accurate. The points you have plotted must correspond to the location in the mission directive.

Step 5. Place the stereoscope over the aerial photographs, with the left lens placed over the left photo and the right lens over the right photo. Look through the stereoscope and adjust the photographs slightly so you will get the best possible stereo images. Features will appear to be three-dimensional if you have obtained stereovision.

Step 6. Determine intervisibility. After positioning the stereoscope over the photos, look through your stereoscope. The two lines will fuse into one line. If it appears to float above the ground, you have determined intervisibility. If the line appears to cut through the ground, you have not. By determining intervisibility between two points, you have also determined LOS between them.

ZONE OF ENTRY

Categories

A zone of entry (ZOE) is any area in which forces, supplies, or equipment can be placed within reach of an objective area. In most situations, it may also be a zone of exit. Be prepared to show good exit zones from each ZOE, as exit zones play a key role in the selection of ZOE. Types of ZOE are existing airfields, air landing zones (ALZs), helicopter landing zones (HLZs), paratroop/resupply drop zones (RDZs), ports, and amphibious landing beaches.

The three considerations of ZOE are customers, terrain, and climate. Customer consideration includes unit type and size, movement plans, and equipment type, size, and loads. Terrain consideration includes vegetation, slope, surface materials, obstacles, and surface drainage. Climatic considerations include temperature, air density, air pressure, wind, speed, and visibility. See Figure 7-2 for potential obstacles.

Airfields

POTENTIAL OBSTACLES FOR ENTRY ZONES		
Ditches	Tree stumps	Cuts and fills
Embankments	Stone walls	Hedge rows
Large rocks	Bushes	Scattered trees
Boulders	Buildings	Barbed wire fences
Wood fences	Minefields	Cemeteries
Quarries	Levees	Karst topography
Ruins	Towers	Overhead power lines
Rice paddy dikes		Overhead telephone lines

Figure 7-2. Potential obstacles for entry zones

Description

You can select existing airfields as potential ZOE if they meet the minimum size requirement dependent on the type of aircraft to be used. The easiest way to show an existing airfield on a ZOE overlay is to use the same symbol that is used on the transportation overlay, so the customer will know the runway length, width, orientation, and pavement status.

Criteria

Airfields should accommodate the maximum size aircraft, have airfield facilities, and be in correct orientation to the map scale. See Chapter 2 for information concerning the elements of an airfield. See Figures 7-3, 7-4, 7-5.

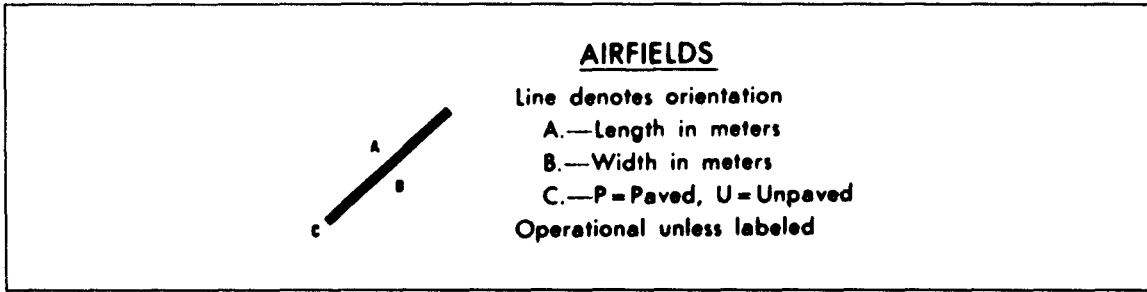


Figure 7-3. Airfield data

Aircraft	Overall dimensions (ft)			Weight (1000 lbs)		Takeoff (ft)*	
	Length	Width	Height	Basic	Maximum takeoff	Ground run	To clear 50 ft
OV-1B	41.7	48.0	13.0	10.98	15.79	1410	2185
OV-1C	41.0	42.0	13.0	10.01	14.82	1440	2230
OV-1D	41.3	48.0	12.7	15.50	17.50	1650	2280
U-8D	31.5	45.3	11.6	4.99	7.30	1455	2400
U-8F	33.3	45.9	14.2	5.49	7.70	1065	1660
U-21A	35.8	45.9	14.2	5.38	9.50	1500	2000
C12A	43.9	54.5	15.4	12.50	17.30	2200	
C12C/D	43.9	54.5	15.4	12.50	16.90	2200	

*At sea level, 59° F, no wind, hard surface

Figure 7-4. Characteristics of fixed wing Army aircraft

Airfield Type	Runway Length ft	Runway Width ft	Runway Shoulder Width ft	Total Aircraft Traffic Area* 1,000 sq ft
Battle Area				
Light Lift and Medium Lift	2,000	60	10	223
Forward Area				
Liaison	1,000	50	NA	37.5
Surveillance	2,500	60	10	337
Light Lift and Medium Lift	2,500	60	10	358
Support Area				
Liaison	1,000	50	NA	50
Surveillance	3,000	60	10	490
Light Lift and Medium Lift	3,500	60	10	753.5
Heavy Lift	6,000	100	10	1,421
Tactical	5,000	60	4	1,071
Rear Area				
Army	3,000	72	10	882
Medium Lift	6,000	72	10	2,362
Heavy Lift	10,000	156	10	3,926
Tactical	8,000	108	20	1,989

*This area includes parking, runway, taxiway, and warm-up apron

Figure 7-5. Minimum airfield requirements

Air Landing Zones

Description

ALZs are entry zones used by fixed-wing aircraft to access objective areas. They can include beaches, dry lake beds, sections of highway, and other areas that meet the criteria. Areas are classified as hasty or deliberate based on the anticipated type of missions or load requirements in a given area within the theater of operations. Hasty ALZs are unimproved surfaces good only for marginal weather operations and are unusable during prolonged periods of poor weather. Deliberate ALZs have all-weather capability and are usually permanent installations with control towers, runways, and taxiways. Deliberate classifications meet existing airfield criteria.

Figure 7-6 shows symbols for ALZ criteria. See TM 5-330 and FM 100-27 for specific information.

Criteria

- Undissected
- % Slope - per 100-foot horizontal distance
- No obstructions within glide angle of ALZ
- Oriented with prevailing winds
- Suitable Surface Materials and Surface Roughness

Procedures

Refer to FM 5-330 to determine proper values, then use the following formula to compute ALZ length:

$$\text{ALZ Length} = \text{TGR} + \text{ALT Cor} + \text{Temp Cor} \times \text{SF} + \text{Slope Cor}$$

Round Up.

Note: Round up the final ground run length to the next highest 100 foot value.

Example. ALZ length of 3,120 feet is rounded up to 3,200 feet.

Where:

TGR = Takeoff ground run at mean sea level and 59°F.

ALT Cor = Pressure altitude correction.

Add the dh value of entry zone based on FM 5-330 to the altitude of the entry zone, then increase the TGR by 10 percent for each 1,000-foot increase in altitude.

Temp Cor = Temperature correction. If the corrected ground run obtained in the previous computation is 5,000 feet or greater, increase the ground run by 7 percent for each increase in temperature above 59°F; if less than 5,000 feet, increase by 4 percent per 10° above 59°F. If the temperature is less than 59°F, no correction is required.

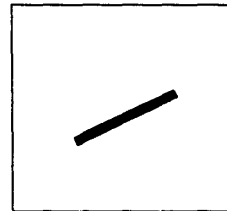


Figure 7-6. Air landing zone symbol

SF = Safety factor. Multiply the corrected ground run obtained in the previous computation by 1.5 for rear- area ALZs and 1.25 for support, forward, and battle area airfields.

Cor = Effective gradient correction. Increase the corrected ground run obtained in the previous computation by 8 percent for each 1 percent of effective gradient over 2 percent.

Round up = Round the final ground run length up to the next larger 100 feet.

Compare the final ALZ length and width to the minimum runway length and width shown in TM 5-330 and use the larger of the two lengths and widths.

Helicopter Landing Zones (HLZs)

HLZs are entry zones in which helicopters access an objective area. They are terrain and climate dependent. Even under the best weather conditions, using a vertical approach and departure, the helicopter requires flat and obstacle-free open areas and a surface material that will support the heavy loads of the aircraft. The load factor, elevation, and air temperature determine whether the helicopter can take off and land vertically. Helicopter approach and departure angles that are not vertical require longer distances to clear obstacles surrounding the edges of the entry zone.

Criteria

- Undissected
- Less than 15 percent slope (See FM 90-4)
- Minimum size should be based on METT-T (20 - 75m guide, minimum distance for a single helicopter)
- No vertical or ground obstructions greater than or equal to 18 inches
- 10:1 obstacle clearance ratio
- No dust, debris, or loose snow near LOC
- Stable soils

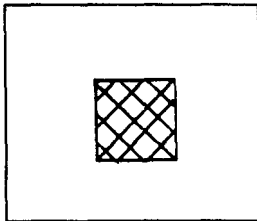


Figure 7-7.
Helicopter landing

Use the following formula to compute the size of the HLZ during daylight:

$$LS = \frac{2(RTZ + HO)}{\tan DA}$$

Where: LS = diameter of helicopter site

2 = safety factor

RTZ = radius of touch zone

HO = height of obstacle

DA = tangent of departure or approach angle in degrees, whichever is smaller

Compare the final HLZ length and width to the minimum length and width shown in FM 5-35. See Figures 7-8 and 7-9.

Use the following formula during hours of darkness:

$$LS (\text{Daylight}) \times 1.43 = LS (\text{Darkness})$$

Helicopter	Overall dimensions (ft)			Weight (1000 lbs)		Takeoff (ft)*	
	Length	Width	Height	Basic	Takeoff	Ground run	To clear 50 ft
OH-6A	30.30	26.30	8.20	1.16	2.70	0	0
OH-58A	41.00	6.60	9.65	2.76	3.00	0	0
OH-58C	42.00	6.60	9.40	2.92	3.20	0	0
UH-1D	57.01	48.00	17.16	4.92	9.50	0	0
CH-47	99.00	59.16	18.70	23.00	33.00	0	0
CH-54	88.41	72.00	25.33	19.82	42.00	0	0
AH-1	52.97	44.00	11.00			0	0

*At sea level, 59° F, no wind, hard surface

Figure 7-8. Characteristics of Army helicopters

Where: LS (Daylight)= Diameter of landing site during daylight

1.43 = Safety factor for darkness

LS (Darkness)= Diameter of landing site during darkness

Drop Zones (DZs)

Helipad or Heliport Type	Landing pad			Taxi/ Hover Lane ¹	Runway ²		
	Length ft	Width ft	Shoulder Width ft	Width ft	Length ft	Width ft	Shoulder Width ft
Forward Area							
OH-6A	12	12	NA	75	NA	NA	NA
UH-1H	20	20	NA	140	NA	NA	NA
CH-47	50	25	NA	180	NA	NA	NA
CH-54	50	50	NA	200	NA	NA	NA
Support Area							
OH-6A	12	12	10	100	NA	NA	NA
UH-1H	20	20	10	200	NA	NA	NA
CH-47	50	25	10	240	450	25	10
CH-54	50	50	10	250	450	50	10
Rear Area							
OH-6A	25	25	25	100	NA	NA	NA
UH-1H	40	40	25	200	NA	NA	NA
CH-47	100	50	25	240	450	40	25
CH-54	100	100	25	250	450	60	25

¹ Taxi/hover lane is used for takeoff and landing where provided, length is variable
² Where runway is not shown, takeoff and landing are on taxi/hover lane

Figure 7-9. Minimum helipad and heliport requirements

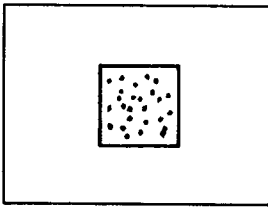


Figure 7-10. Drop zone symbol

DZs are entry zones in which troops or materials are delivered by parachute within a close proximity of an objective area. They are sometimes called resupply drop zones, when supplies are delivered to troops.

Criteria

- Undissected
- Less than 10 percent slope is preferred, 30 percent is allowable for supply drops
- Within 30km of a key city
- DZ near LOC
- No instructions within 1km
- Must have routes of entry or exit
- DZ has accessible cover and concealment
- Minimum width and length is dependent on the type, formation and speed of the aircraft, surface winds, the number of personnel or type of cargo being dropped, and visibility.
- For more information see FM 100-27.

Ports

Description

Ports may be used as entry zones when ships deliver troops and equipment close to the objective area. The selection of a port as an entry zone is based on geographic location, climatic conditions, and existing port facilities. Considerations include

PORT CATEGORIES			
Category	Vessel	Water depth	Other
Deep draft*	Naval	10 meters	
	Container	10-15 meters	
	Bulk carrier	12-18 meters	
	Tankers	10-28 meters	
Shallow draft**	Lash	2 meters	2 meters
	Seabee	3.4 meters	31 meters
	Barge	38 meters	38 meters
*Each vessel hatch requires 30 meters of wharf space, with the wharf at least 30 meters wide.			
** The wharf length must be 12 meters.			

Figure 7-11. Port categories

basin protection, bottom condition, shore area, communications, and water depth.

Port categories are deep draft, which includes ocean-going vessels, and shallow draft, which includes lighters, barges, and landing craft. See Figure 7-11.

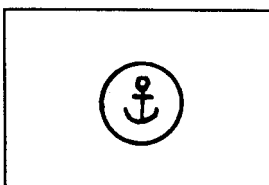


Figure 7-12. Port symbol

Criteria

- Water depth greater than 2 meters
- Minimum length 30 meters per hatch
- Exit route to Main Supply Route (MSR)
- Near LOC
- Near facilities

DMA Pub 150 lists ports worldwide. See also FM 5-35.

Amphibious Landing Beaches

Amphibious landing beaches are entry zones in which troops and equipment are involved in a transition from seaborne to a land attack force within a close proximity to the objective area. The criteria used for determining the location of an amphibious landing zone is based on geographic and climatic conditions at the entry zone. However, due to the transition from sea to land, the geographic conditions are divided into two areas: conditions of the terrain at the entry zone and hydrographic conditions at the entry zones. Additional considerations include weather, extent, depth, and bottom of the sea area, beach approach, beach gradient, and hinterland (depth, concealment and transportation net).

Criteria

- Underwater gradient 30:1
- Lack of underwater obstacles
- Firm bottom
- Trafficable soils exit
- Tide information
- Open, straight-shot of beach -no enemy salients

SYNTHESIS PROCEDURES

Step 1. Review requirements to determine the type and criteria of the ZOE for the projected area.

Step 2. Obtain source material, including base topographic map, aerial photography, and the vegetation, surface configuration, surface materials, obstacles, surface drainage, and transportation factor overlays.

Step 3. From the vegetation-factor overlay, extinct the following No-Go area:

- All built-up areas
- Vegetation categories A2, A3, B1, B2, C1-C4, D1-D4, E1-E4, F, I, J, K, L, M
- Agriculture (A1) that includes bamboo, rice fields, and vineyards.

Step 4. From the surface-configuration-factor overlay extract the following No-Go areas:

- Any slope greater than 2 percent for ALZs
- Any slope greater than 15 percent for HLZs
- Any slope greater than 30 percent for DZs

Step 5. From the surface-materials-factor overlay extract the following nonacceptable soil types:

- Permanent snowfields
- Peat bogs

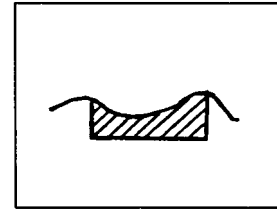


Figure 7-13.
Landing beach
symbol

- Rock outcrops
- Permanent wet soils
- Surface roughness with a category of 3 or 4

Soil is probably not as important a factor as vegetation or slope. However, powdery, dry soil in arid climates must be considered an impediment to helicopter landing because of the reduced visibility, possible clogging of engine intakes, and revealed helicopter location due to generation of dust plume. Very wet or mucky soil may cause the helicopter wheels to settle into the soil to such an extent as to prevent the accomplishment of the mission. Thus, soil conditions can be dangerous to a helicopter and should always be considered when selecting a landing zone site.

Surface roughness affecting helicopter landing can include rocks, ridges, domes, and sandbars. Skilled terrain analysts must determine surface roughness, visualizing the landform and making decisions concerning surface irregularities. For example, some landforms of glacial origin commonly contain potential obstacles such as boulders that are not mapped topographically and may be too small to be seen on some aerial photography.

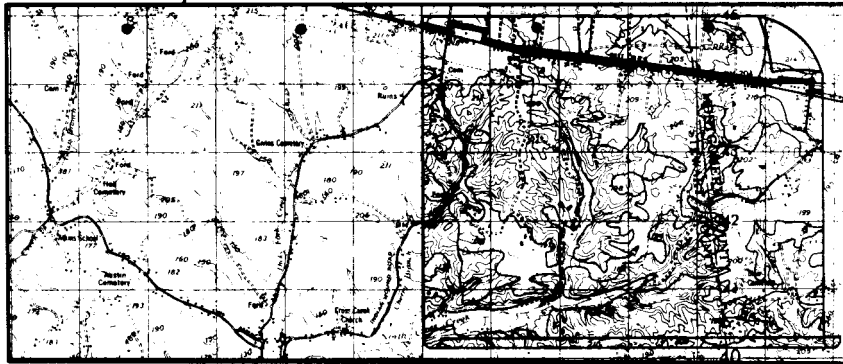
Step 6. From the obstacle-factor overlay, extract all obstacles that are within the project area.

The two types of obstacles associated with helicopter landing zone sites are vertical obstacles, which affect helicopter approach to and departure from a landing site, and ground obstacles within the landing site such as rocks, stumps, and holes. Approach and departure obstacles include power lines, transmission towers, and chimneys. These obstacles appear on standard 1:50,000-scale topographic maps from which you can compile a factor overlay. Obstacles within the landing site may not be detected easily. You must rely on ground reconnaissance, low-altitude photography, or local geographic literature.

Step 7. From the transportation-factor overlay, extract all existing airfields that meet the criteria for ZOE's.

Step 8. Evaluate all open areas and select the ZOE's needed for the projected area. If available, evaluate the areas against the CCM's and LOC's of the area.

The criteria for minimum-size requirements depends on a number of factors, including the type and number of aircraft, supplies, or troops to land in the ZOE, temperature, wind, altitude, and geographic location. Therefore, use the criteria listed for minimum areas as a guide and revise it as needed.



Final Overlay Preparation

Chapter 8

After you have collected and processed the data, use the following steps to prepare the final overlay:

Step 1. Lay out the base map on a flat working surface, taping it on all four corners.

Step 2. Orient the working overlay to the base map. Check registration marks on the draft overlay and line them up with the corners on the base map. Tape the working overlay to the base map on all four corners.

Step 3. Register the overlay material to the base map by tracing corner ticks from base map onto the overlay material, using a fine point pen, so they form an L approximately .5 inches by .5 inches.

Step 4. Place the security classification at the top and bottom center of the overlay.

Step 5. Trace the outline of areas identified on the working overlay onto the final overlay, and use the appropriate letters to correspond with the area. Do this with each area to be outlined, until you have outlined all areas and depicted them with the correct letters.

Step 6. Place marginal data on the overlay according to Figure 8-1.

Step 7. Construct a legend depicting all symbols used on the draft overlay.

Step 8. Check the overlay for completeness, accuracy, and legibility.

Step 9. Remove the overlay from the base.

Step 10. Attach a classified cover sheet if it is required.

Step 11. Deliver the overlay to your supervisor for review and storage.

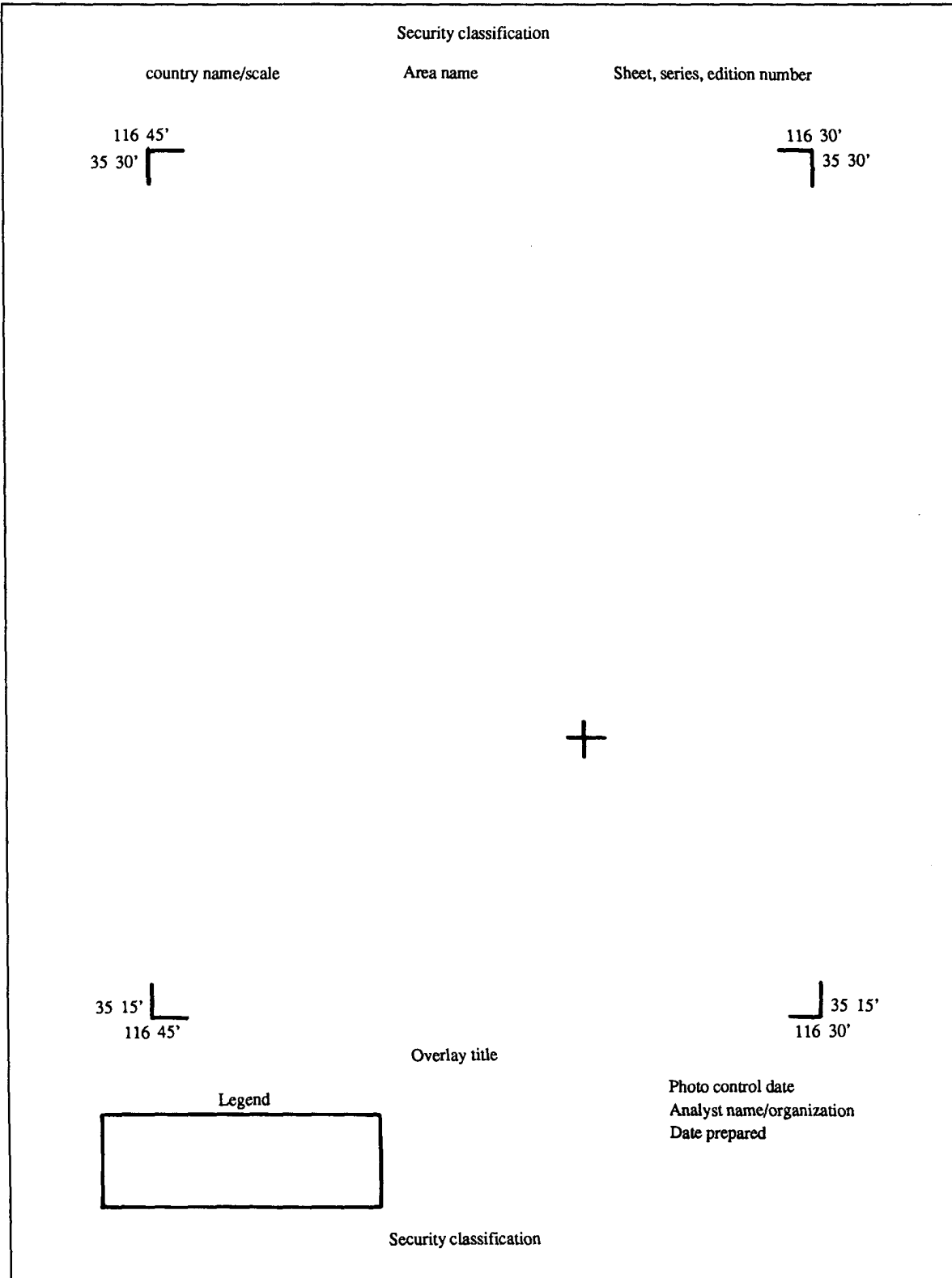


Figure 8-1. Example for map overlay



Vertical Photography

Chapter 9

Vertical photography is the process and the product of aerial photography taken with the axis of the camera held in a truly vertical position. If the vertical photography is taken over flat terrain, measured distances and directions may approach the accuracy of a line on a map. Procedures for determining measurements for vertical photography follow.

SCALE DETERMINATION

The linear scale is the relationship between distance on a map or photo and the actual ground distance. Scale is expressed as a representative fraction (RF). RF may be determined by one of three basic formulas:

$$RF = \frac{f}{H} \text{ or } \frac{f}{H-h} \quad RF = \frac{PD}{GD} \quad RF = \frac{P}{MD \times MSR}$$

Where--

- RF= The representative fraction or the scale of the imagery
- f = The focal length of the camera
- H= Height of aircraft above sea level
- h = average terrain height above sea level
- PD = Photo distance on picture
- GD = Actual ground distance
- MD= Distance on map
- MSR = Map scale reciprocal

Example: Find the RF of a photo where f equals 6 inches and H equals 5,000 feet.

$$RF = \frac{f}{H}$$

$$RF = \frac{6 \text{ in}}{5,000 \text{ ft}}$$

$$RF = 1:10,000$$

GROUND DISTANCE DETERMINATION

You must know the photo representative fraction (PRF) or the map representative fraction (MRF) to use the MSR or the PSR ground distance determination. To

determine the actual distance or size of an object on an aerial photograph or map, use one of two formulas:

$$GD = PD \times PSR \text{ or } GD = MD \times MSR$$

Where--

GD = Ground distance
 PD = Photo distance
 MD = Map distance
 PSR = Photo scale reciprocal
 MSR = Map scale reciprocal

Example Find the GD covered by a photo where the PD = 0.026 feet and PRF = 1:8800.

$$GD = PD \times PSR$$

$$GD = 0.026 \text{ feet} \times 8800 \text{ feet}$$

$$GD = 228.8 \text{ feet}$$

PLOTTING TEMPLATE ADJUSTMENT

The plotting template is an adjustable instrument used for plotting vertical aerial photographs. The four sides of the template are graduated in inches and five hundredths of inches and may readjusted to any combination of lengths and widths from 0.05 inches by 0.05 inches to 5.0 inches by 5.0 inches. You can adjust the template during inspection or with the formula--

Where--

TS = Template setting in inches
 PS = Photo side (in inches)
 PSR = Photo scale reciprocal
 MSR = Map scale reciprocals

Example Find the TS of a photo where PS equals 9 inches by 9 inches, PRF equals 1:5000, and MRF equals 1:25,000.

$$TS = \frac{PS \text{ (inches)} \times PSR}{MSR}$$

$$TS = \frac{9 \text{ inches} \times 5,000}{25,000}$$

$$TS = 1.8 \text{ inches} \times 1.8 \text{ inches}$$

PROPORTIONAL DIVIDERS USE

The proportional divider is an adjustable, compass-like instrument designed especially for enlarging or proportionally reducing drawings and sketches. Use the formula---

$$\text{scale ratio} = \frac{MSR}{PSR} \text{ or } \frac{PSR}{MSR}$$

Where--

scale ratio = Proportional divider setting
 MSR = Map scale reciprocal
 PSR = Photo scale reciprocal

Example Find the scale ratio when MRF equals 1:25,000 and PRF equals 1:5,000.

$$\begin{aligned} \text{scale ratio} &= \frac{MSR}{PSR} \\ \text{scale ratio} &= \frac{25,000}{5,000} \\ \text{scale ratio} &= 5:1 \end{aligned}$$

PHOTO COVERAGE

Photo coverage is the ground area captured on any photo. It may be expressed in square feet, square yards, or square miles. You can determine photo coverage by using the formula--

Where-- $PSC = PSR \times PS$

PSC = Photo side coverage on the ground
 PSR = Photo scale reciprocal
 PS = Photo side

Example Find the ground distance covered by each side of a photo with RF equals 1:10,000 and photo format equals 9 inches by 9 inches.

$$\begin{aligned} PSC &= PSR \times PS \\ PSC &= 10,000 \times 9 \text{ inches} \\ PSC &= 10,000 \times 0.75 \text{ feet} \\ PSC &= 7,500 \text{ feet} \end{aligned}$$

The total ground area covered by this photo is 7,500 feet by 7,500 feet or 56,250,000 square feet.

PHOTO COVERAGE FOR A SPECIFIC AREA

The photo coverage for a specific area refers to the number of photos required to cover a predetermined area at a desired scale and format size. You must know--

- The desired scale of the photography.
- The photo format.
- The size of the area to be covered.
- The percentage of forward overlap between photos.
- The percentage of side lap between flight lines.

Example Determine the number of photos required to cover an area 36,000 feet by 30,000 feet.

Where-- Photo format = 9 inches by 9 inches
 Desired scale = 1:5,000
 Forward overlap = 60 percent
 Sidelap = 40 percent

Step 1. Determine the ground-area coverage of a single photo.

$$\begin{aligned} \text{Area coverage} &= \text{format} \times PSR \\ \text{Area coverage} &= .75 \text{ feet} \times 5,000 \\ \text{Area coverage} &= 3,750 \text{ feet} \times 3,750 \text{ feet} \end{aligned}$$

Step 2. Determine the amount of ground gained forward (Ggf).

$$\begin{aligned} \text{Ggf} &= \text{Total area coverage} \text{ minus forward overlap percentage} \\ \text{Ggf} &= 3,750 \text{ feet} \times 40\% \\ \text{Ggf} &= 1,500 \text{ feet} \end{aligned}$$

Step 3. Determine the amount of ground gained sideways (Ggs).

$$\begin{aligned} Ggs &= \text{Total area coverage minus sidalap} \\ &\quad \text{percentage} \\ Ggs &= 3,750 \text{ feet} \times 60\% \\ Ggs &= 2,250 \text{ feet} \end{aligned}$$

Step 4. Determine the minimum number of photos per flight line.

$$\begin{aligned} \text{Photo per flight line} &= \frac{\text{length of area}}{Ggf} \\ \text{Photo per flight line} &= \frac{36,000ft}{1,500ft} \\ \text{Photo per flight line} &= 34 \end{aligned}$$

Step 5. Round off photos per flight line to the next higher number when an uneven number exists. Add two photos to each end of the flight line to ensure complete stereo coverage.

Step 6. Determine the number of flight lines.

$$\begin{aligned} \text{Flight lines} &= \frac{\text{Area width}}{Ggs} \\ \text{Flight lines} &= \frac{30,000}{2,250} \\ \text{Flight lines} &= 13 + \end{aligned}$$

Step 7. Round off the number of flight lines to next higher number when an uneven number exists.

$$13+ = 14 \text{ flight lines}$$

Step 8. Multiply the number of photos per flight line by the number of flight lines to get the total number of photos required to complete the mission.

$$14 \times 38 = 532 \text{ Photos required}$$

HEIGHT DETERMINATION

Parallax Method

When you photograph a tall object from the air in two successive exposures, the position of the point between the two photos appears to change. This displacement is called parallax, which you can measure to determine the height of an object or the elevation of a point, using two overlapping vertical photos and taking measurements in a prescribed manner. This is the most accurate method of measuring height.

Step 1. Attach the parallax bar to the cross member of the stereoscope legs with the gage to the right. Push the ends of the bar down to engage the spring clips. Slide the bar as close to you as the stereoscope legs will permit. This will place the dots directly below the stereoscope lens. (See Figure 9-1.)

Step 2. The stereometer is a stereoscope with special measuring attachments. Under each lens is a glass plate that rests on its respective photograph of a stereoscopic pair. On the bottom of each glass plate is a small dot. The dot under the left lens remains in a fixed position. You can move the dot under the right lens by an adjusting knob along the eye base of the stereometer. The movement of the

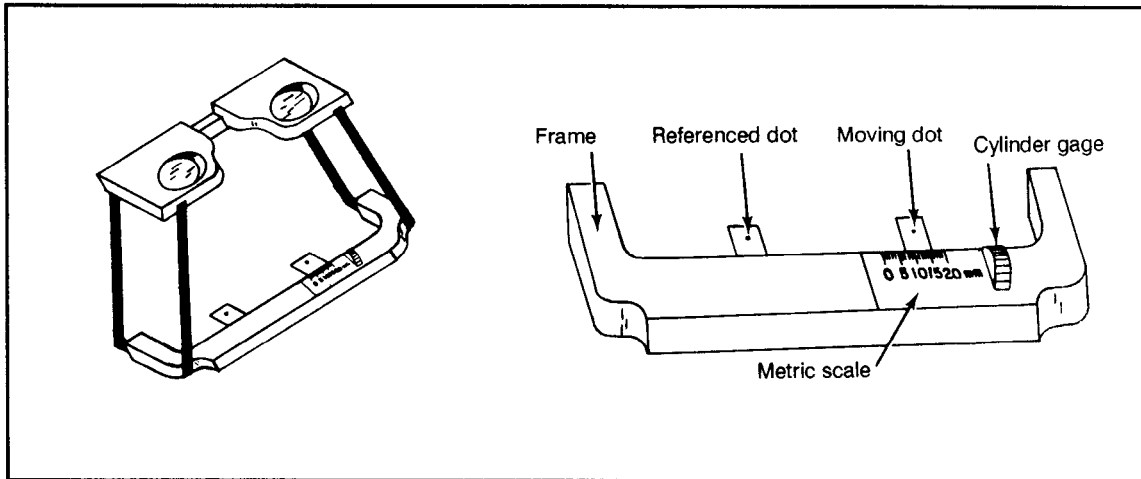


Figure 9-1 Stereoscope

right dot is measured by a micrometer dial. The range of distance between the dots is significant. For example, when you turn the adjusting knob on a stereometer so that the dots are at minimum separation, they may be 60 millimeters apart. When you turn the adjusting knob so that the dots are at a maximum separation, they may be 70 millimeters apart.

Corresponding points on two photographs must be between 60 and 70 millimeters apart when the photographs are properly oriented for stereoscopic vision. Relative to the graduation of the instrument the numbers may increase or decrease in magnitude when the dots converge. For example, if there is a range of 10 millimeters between minimum and maximum separation of the dots, the readings may be 0 at minimum and 10 at maximum or 0 at maximum and 10 at minimum, depending on the type of stereometer.

Step 3. Use fiducial marks to locate and mark principal points of both stereo paired photographs. Both photos have their own principal points but also contain the principal point of the adjacent photo in the aircraft flight line. To locate these points, transfer them from one adjacent photo to another with a stereoscope. Orient the photos for stereo viewing, locate the marked principal point, and mark the same point on the adjacent photograph. Repeat this procedure with the other photo. Each photo now has a principal point and a transferred principal point (see Figure 9-2).

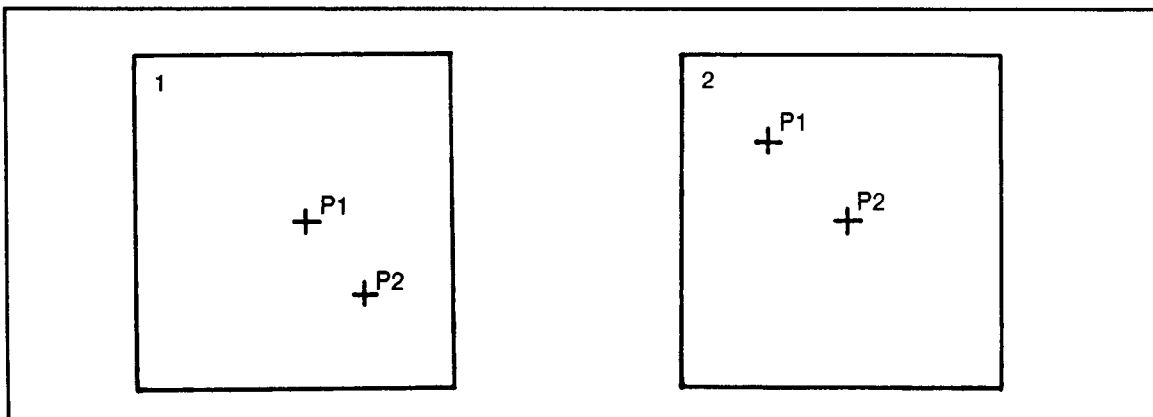


Figure 9-2 Point Transfer

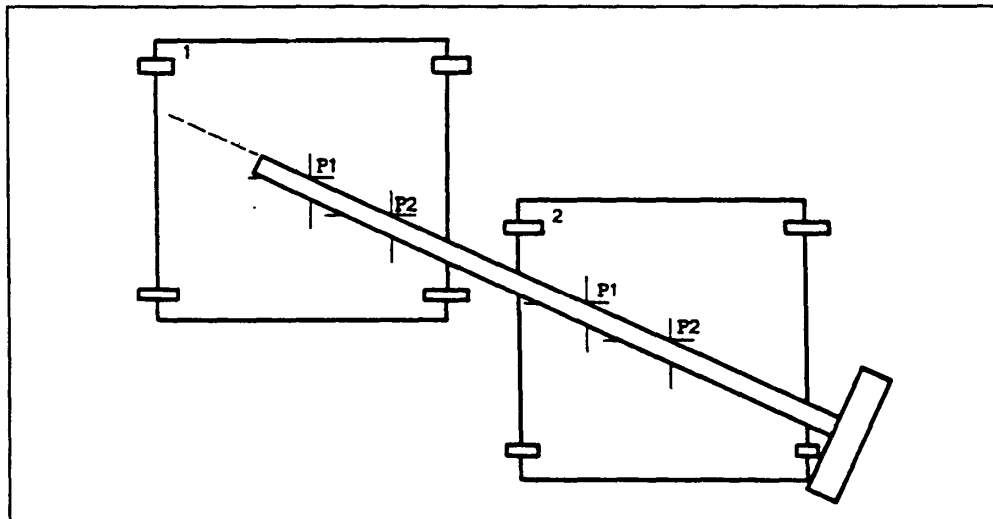


Figure 9-3 Flight Line

Now you can establish the flight line by drawing a line from the principal point to the transferred principal point on each photograph (see Figure 9-3). Measure the distance from the principal point to the transferred principal point (see Figure 9-4). Average these measurements using the formula--

$$b_m = \frac{b_1 + b_2}{2}$$

Where--

- b_m= base means
- b₁= measurement from the principal point to the transferred principal point on photo #1
- b₂= measurement from the principal point to the transferred principal point on photo #2

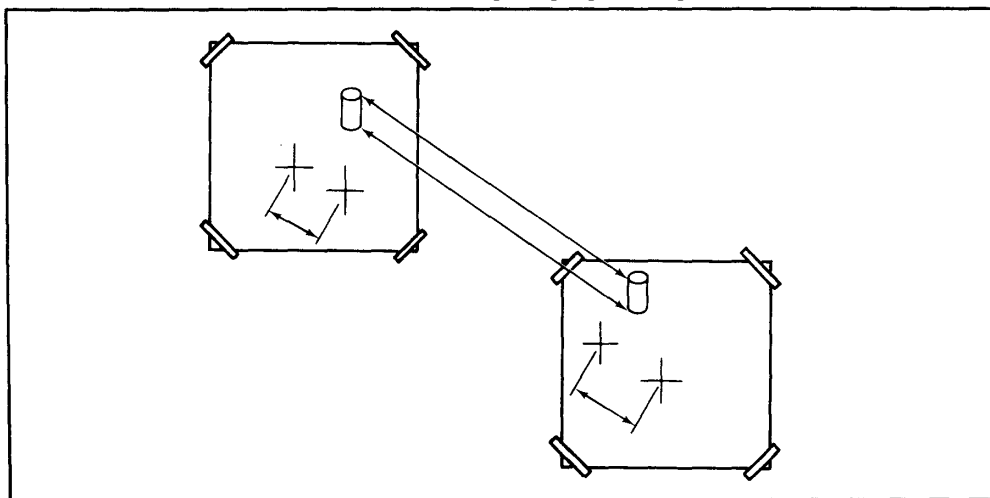


Figure 9-4 Point Measurement

Step 4. Locate the feature that you will measure using the stereoscope and stereometer. Measure the top of the feature first to obtain the first parallax measurement p_1 . Then measure the bottom of the feature to obtain the second parallax measurement, p_2 . To obtain a parallax measurement, you must place the photos so you can see them in stereo. With the stereometer attached to the stereoscope, you can see a left and right dot through the eyepieces. Place the left dot on the point to be measured, then rotate the micrometer knob until the right dot fuses with the left dot. Record the micrometer reading as shown on the scale.

After you have taken both parallax measurements (p_1 and p_2), find the differential parallax (Δp) to help determine the height of the feature, using the equation below. You can use p , as a function of the elevation of the feature being measured, to calculate the height of any natural or manmade object.

$$\Delta p = p_1 - p_2$$

Step 5. Since all elevations are relative to each other, you must establish a reference elevation to measure height differences. This reference elevation is the average terrain elevation above mean sea level, the horizontal plane above which an aircraft photographs. You can reference the terrain elevation of certain objects shown on aerial photography from topographic maps of the same area. This data can be used to provide an estimation of the average terrain elevation (h). For parallax height determination, you must also know the altitude of the aircraft, which you can determine from the marginal information on the aerial photograph. The altitude shown on the photo is the aircraft height above mean sea level (H).

Step 6. Once you have taken all measurements from the stereo-paired photographs, you can use the parallax equation to solve height determination, as follows:

Example:

a. Determine the base means.

$$b_m = \frac{b_1 + b_2}{2}$$

$$b_m = \frac{.305' + .313'}{2}$$

$$b_m = \frac{.618'}{2}$$

$$b_m = .309'$$

b. Determine the differential parallax.

$$\Delta p = p_1 - p_2$$

$$\Delta p = .0435 \text{ feet} - .0410 \text{ feet} = .0025 \text{ feet}$$

c. Determine height.

$$\text{Height} = \frac{(H - h) \times \Delta p}{b_m + \Delta p}$$

$$\text{Height} = \frac{(5,990 \text{ ft} - 640 \text{ ft}) \times .0025 \text{ ft}}{.309 \text{ ft} + .0025 \text{ ft}}$$

$$\text{Height} = \frac{(5,350 \text{ ft}) \times .0025 \text{ ft}}{.3115 \text{ ft}}$$

$$\text{Height} = \frac{13.38 \text{ ft}^2}{.3115 \text{ ft}}$$

$$\text{Height} = 43 \text{ feet}$$

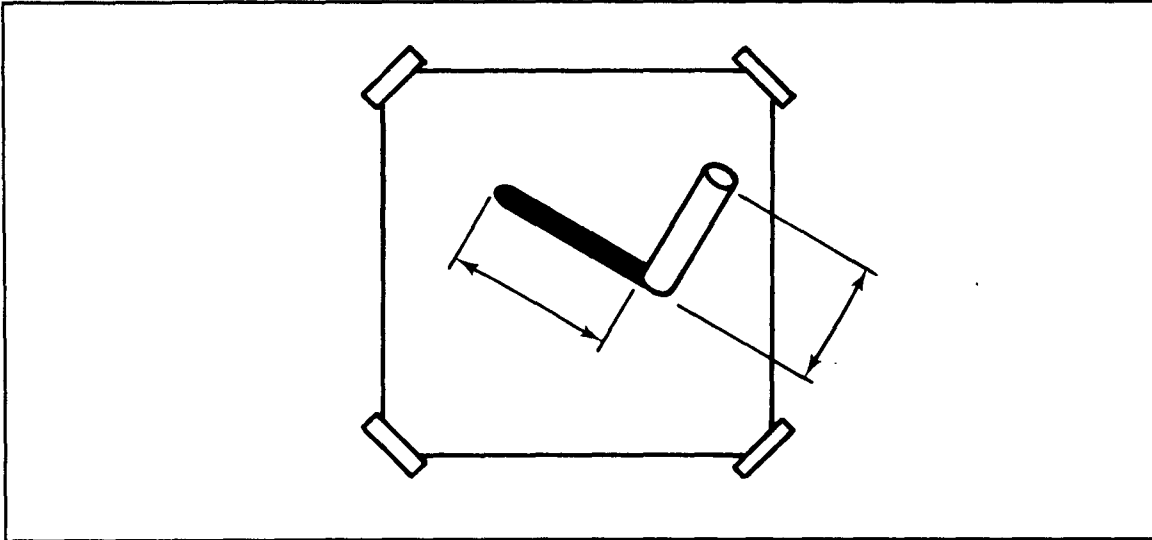


Figure 9-5 Shadow Measurement

Shadow Method

The shadow method is the least accurate of the three methods. You must have an object with a known height, and the unknown object must cast a shadow onto flat ground (see Figure 9-5). If the ground is uneven, the answer will be inaccurate. For any relatively small area of level ground, shadow length is directly proportional to object height. For example, a 40-foot tower casts a shadow twice as long as a 20-foot tower. If the shadow lengths are in a certain ratio, their photo images will be in the same ratio. To determine the height of an unknown object, measure its shadow length and multiply it by the ratio of height to shadow length established from the known object. Using the microcomparator or the photo interpreter's scale, measure the height of the unknown object and its shadow length. Place those measurements into the equation and determine the height using the following formula

Example: $h_k = 123$ feet
 $s_k = .027$ feet
 $s_u = .012$ feet

$$h_u = \frac{h_k \times s_u}{s_k}$$

$$h_u = \frac{123 \times .012'}{.027'}$$

$$h_u = 55 \text{ feet}$$

Where--

h_u = height of unknown object
 k = height of known object
 S_u = shadow length of unknown object
 S_k = shadow length of known object

Relief Displacement Method

The determination of height from relief displacement employs a single, vertical aerial photograph where both the base and the top of a vertical object are measurable. This method is particularly effective on large-scale imagery. For it to work, the displacement of the image must be visible. The formula for determining the height of an object based on its relief displacement is--

$$\text{Hgt} = \frac{\text{displacement} \times \text{flying height}}{\text{radial distance}}$$

$$\text{Hgt} = \frac{d \times (H - h)}{r}$$

Hgt = Height of the object above the average terrain elevation

H = Altitude of the aircraft above mean sea level

h = Average terrain height above mean sea level

H-h = Altitude above ground level

d = Image distance representing vertical side of the object

r = Distance between principal point and top of the object scaled from the photograph

You will first need to use a straightedge and mark the center of the photograph with fiducial marks. Always measure r from the top of the object to the center of the photograph, which you must determine by the intersection of the lines connecting the opposite fiducial marks. Measure d between the same point on the top and on the bottom of the object. The top of the object is always farther away from the center of the photograph than the bottom (see Figure 9-6). Using the photo-interpreter's scale, measure the distances and place the numbers into the equation, using procedures discussed earlier.

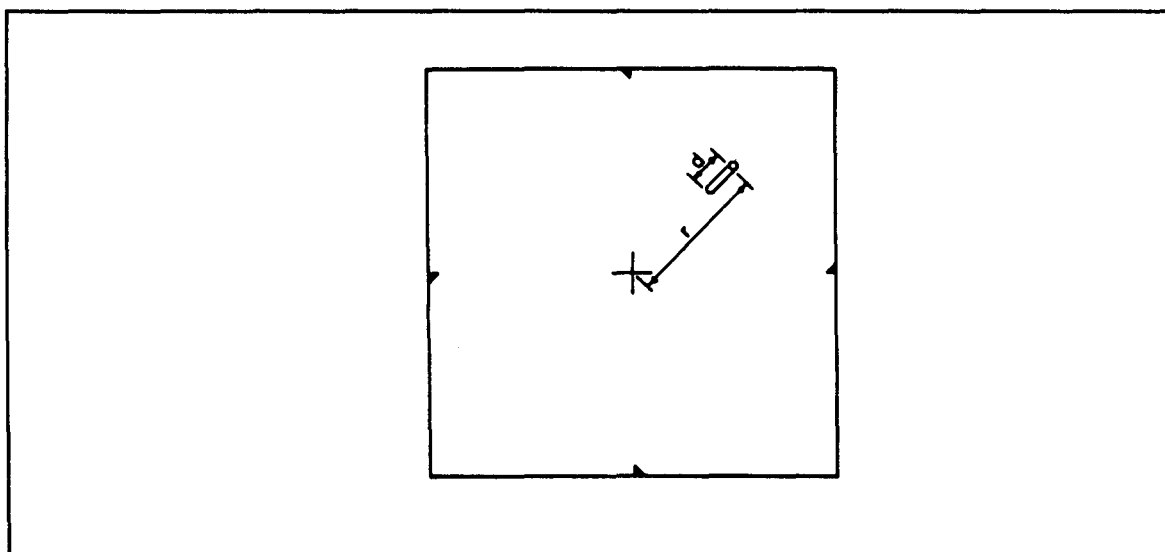


Figure 9-6 Displacement Measurement

Example

$$Hgt = \frac{dx(H-h)}{r}$$

$$Hgt = \frac{.017 ft \times 4,750 ft}{.261 ft} = 309 ft$$

AREA MEASUREMENT

You can use the dot grid template to measure area. Randomly place it on the lake or area to be measured. Count the dots that fall within the lake and those that fall on the line. Record the number, repeat the procedure at least three times, and determine the mean number of dots by adding the numbers together and dividing by the number of counts.

Example

First count	=	13
Second count	=	12
Third count	=	12
13+12+12	=	37
	$\frac{37}{3}$	= 12.3
Mean number of dots	=	12.3

Step 1. Calculate the area in cm using the formula:

$$cm^2 = \frac{MEAN\ NUMBER\ OF\ DOTS}{25}$$

Example:

$$cm^2 = \frac{12.3}{25}$$

$$cm^2 = .49 cm^2$$

Note: Dots per cm² in this example are 25. Other dot grids are available, so check in each case to determine the dots per cm².

Step 2. Calculate the ground area using the formula--

$$Area = object\ area\ in\ cm^2 \times DRF^2$$

Example:

$$DRF = 24,000$$

$$DRF^2 = 5.76 \times 10^8$$

$$Area = (.49 cm^2 \times (5.76 \times 10^8))$$

$$Area = 2.8224 \times 10^8 cm^2$$

Where-- DRF = the denominator of the map or photo RF

Step 3. Convert the answer you obtained in Step 2 to square meters, using the formula--

$$m^2 = cm^2 \times .0001$$

$$m^2 = (2.8224 \times 10^8 cm^2) \times (.0001)$$

$$m = 28,224$$

Examples:

- a. Calculate the volume of a lake which is 3 meters deep and has a surface of $28,800\text{m}^2$.

$$\text{Volume} = 28,800\text{m}^2 \times 3\text{m}$$

$$\text{Volume} = 86,400\text{m}^3$$

- b. Calculate the lake volume in gallons.

$$\begin{aligned} 1 \text{ m}^3 &= 264.7 \text{ gallons of water} \\ \text{Number of gallons} &= (264.7 \text{ gallons/m}^3) \times (86,400\text{m}^3) \\ \text{Number of gallons} &= 22,870,080 \end{aligned}$$

QPS AREA MEASUREMENT

The QPS computes measurements automatically, greatly helping analysts find surface areas and volumes (see Figure 9-7).

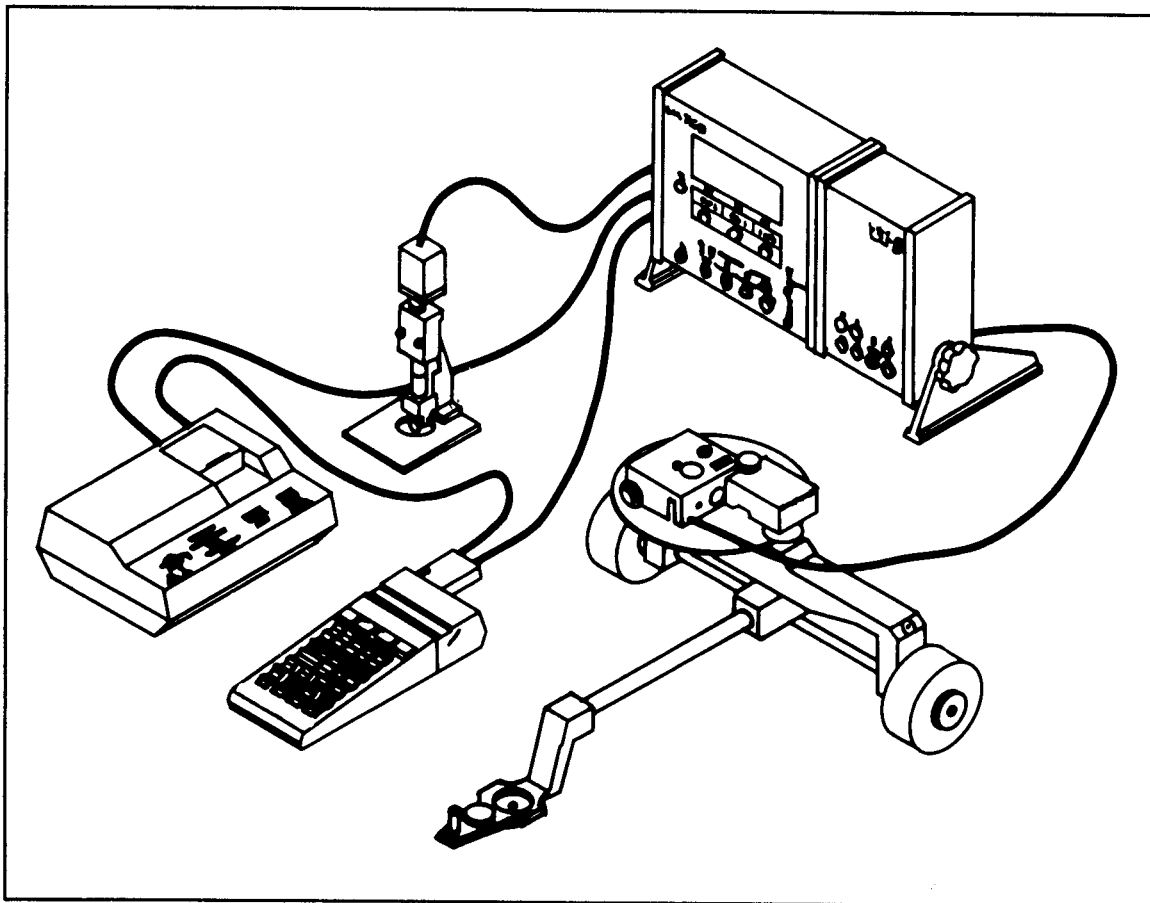


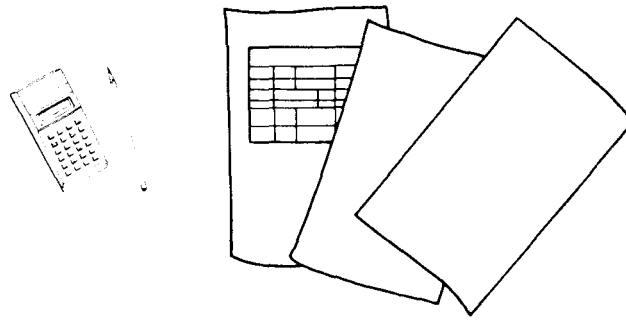
Figure 9-7 QPS

When the operator moves the QPS, it measures length, area, or volume. All measurements are displayed in the proper scale and units, and analysts can print a

hard copy of the measurement results on command or automatically. The QPS is not affected by any detrimental physical condition of a map or photograph that is to be measured, such as tears, wrinkles, or folds. QPS components include--

- A calculator, which is capable of data storage and manipulation.
- A point counter, which enables automatic determination of the count total for specific features or items located on drawings, maps, and so forth.
- A planimeter, which estimates surface areas and volumes.
- A linear measuring probe, which measures lines and distances.

See TM 5-6675-324-14, TM 5-6675-325-14, and TM 5-6675-326-14 for more information on the QPS system. See Appendix C for sources of aerial and ground imagery.



Mathematical Techniques

Chapter 10

GEOMETRIC FUNCTIONS

The result of any operation performed by terrain analysts will only be as accurate as the measurements used. An interpretation and detailed analysis often requires terrain analysts to use basic geometric functions. In addition, approximation of volume, extent of stock piles, and capacity of floor space require geometric formulas. Therefore, analysts must have a sound background in the fundamentals of basic imagery math. This section serves as a guide to a unique and comprehensive collection of current geometric formulas that are basic to all types of imagery interpretation.

Determination of Area

1. Rectangles	FORMULA: $A = l \times W$
Where--	$A = \text{Area}$ $l = \text{Length}$ $W = \text{Width}$
2. Circles	FORMULA: $A = 2\pi r r \text{ or } \pi d d$
Where--	$A = \text{Area}$ $d = \text{Diameter}$ $r = \text{Radius}$ $\pi = 3.142$
3. Triangles	FORMULA: $A = \frac{b \times h}{2}$
Where--	$A = \text{Area}$ $b = \text{Base of the triangle}$ $h = \text{Height of the triangle}$
4. General quadrilaterals	FORMULA: $A = \frac{1}{2} b (h_1 + h_2) \text{ or}$ $A = \frac{b (h_1 + h_2)}{2}$
Where--	$A = \text{Area}$ $h_1 = \text{Height no. 1}$ $h_2 = \text{Height no. 2}$ $b = \text{Base common to two triangles formed by the diagonal}$

Table 10-1 Area Formulas

5. Ellipses	FORMULA: $A = \pi x a x b$
Where--	A = Area $\pi = 3.142$ a = Semi-axis b = Semi-axis

Table 10-1 Area Formulas - continued

Determination of Volume

1. Rectangular solids	FORMULA: $V = l x w x h$
Where--	V = Volume l = Length w = Width h = Height
2. Cylinders	FORMULA: $V = \pi x r^2 x h$
Where--	V = Volume $\pi = 3.142$ r = Radius h = Height
3. Spheres	FORMULA: $V = \frac{4}{3} \pi r^3$
Where--	V = Volume $\pi = 3.142$ r = Radius 3 = Constant
4. Cones	FORMULA: $V = \frac{\pi x r^2 x h}{3}$
Where--	V = Volume $\pi = 3.142$ r = Radius h = Height of cone 3 = Constant
5. Triangular solids	FORMULA: $V = \frac{l x w x h}{2}$
Where--	V = Volume l = Length w = Width h = Height 2 = Constant

Table 10-2 Volume Formulas

6. Trapezoidal solids	FORMULA: $V = \frac{(l+l')h(w+w')}{2}$
Where--	V = Volume l = Length of base l' = Length of top w = Width of base w' = Width of top h = Height 2 = Constant
7. Irregular triangular solids	FORMULA: $V = \frac{wxhx(2a+c)}{6}$
Where--	V = Volume w = Width h = Height a = Length of base c = Length of peak 6 = Constant

Table 10-2 Volume Formulas - continued

Angle of Repose

The angle of repose of any material is the angle at which material will stand when piled. Moisture content is often the controlling factor. The percent of fine material in the mass has a decided influence on the angle, as the fine carries the bulk of the moisture. Screened material has an angle of repose of 35 to 40 degrees.

Table 10-1 gives the average angle of repose and the average weight per cubic foot of various materials of interest to the terrain analyst.


 MATERIAL	ANGLE OF REPOSE (Degrees)	TAN	WEIGHT PER CUBIC FT.
sand, dry	27	0.50952	100 lbs
sand, wet	30	0.57735	115 lbs
gravel	39	0.80978	117 lbs
earth, dry	35	0.70021	90 lbs
coal, anthracite	27	0.50952	52 lbs
coal, bituminous	32	0.62487	47 lbs
coke, industrial	40	0.83910	28 lbs
iron ore, crushed	37	0.75355	145 lbs
copper ore, crushed	37	0.75355	262 lbs
limestone, crushed	37	0.75355	165 lbs

Table 10-3. Angle of Repose

Thus, knowing the angle of repose of a specific material, we can solve for height, using the horizontal dimensions.

Example: Find the height (h) of a pile of limestone.

Formula:
$$h = \tan A \left(\frac{1}{2}b \right)$$

$$h = 0.75355 \times 20 \text{ ft.}$$

$$h = 15.071 \text{ ft.}$$

Where-- $b = 40 \text{ feet}$
 Angle A = 37 degrees
 $\tan 37^\circ = 0.75355$ (from Table 10-1)

TRIGONOMETRIC FUNCTIONS

Oblique photos and thermal and SLAR imagery are often used to supplement or take the place of vertical photographs. In order to ensure maximum use of this imagery, the interpreter must be familiar with certain concepts, formulas, and principles concerning their accurate interpretation. This section gives the terrain analyst a basic understanding of trigonometric functions necessary for solving problems dealing with these special types of imagery, as well as a table of trigonometric conversions.



Six Functions

To define the six trigonometric functions upon which trigonometry is based, consider the angle, initial side AQ, and terminal side AS.

Choose any point B, different from A on the terminal side AS, and drop a perpendicular BC to the initial side AQ. From the three sides (BC, AC, and AB) associated with point B, six ratios are formed which are called the six trigonometric functions of Q.

$$\frac{CB}{AB}, \frac{AC}{AB}, \frac{CB}{AC}, \frac{AB}{CB}, \frac{AB}{AC}, \text{ and } \frac{AC}{CB}$$

These ratios are independent of the position of the point B on the freed terminal side AS, for if we choose any other point B1 on AS and drop the perpendicular B1C1 to the initial side AQ, the two right triangles ABC and AB1C1 are similar. Therefore, their corresponding sides have the same ratios.

If the angle is placed in standard position on a coordinate system, and the distance AB is designated by c, the six trigonometric functions may be defined as follows:

$$\sin \text{ angle} = \frac{CB}{AB} = \frac{\text{Opp Side}}{\text{Hyp}} = \frac{\text{Side } a}{\text{Side } b}$$

$$\cos \text{ angle} = \frac{AC}{AB} = \frac{\text{Adj Side}}{\text{Hyp}} = \frac{\text{Side } b}{\text{Side } c}$$

$$\tan \text{ angle} = \frac{CB}{AC} = \frac{\text{Opp Side}}{\text{Adj Side}} = \frac{\text{Side } a}{\text{Side } b}$$

$$\cot \text{ angle} = \frac{AC}{CB} = \frac{\text{Adj Side}}{\text{Opp Side}} = \frac{\text{Side } b}{\text{Side } a}$$

$$\sec \text{ angle} = \frac{AB}{AC} = \frac{\text{Hyp}}{\text{Adj Side}} = \frac{\text{Side } c}{\text{Side } b}$$

$$\csc \text{ angle} = \frac{AB}{CB} = \frac{\text{Hyp}}{\text{Opp Side}} = \frac{\text{Side } c}{\text{Side } a}$$

To define trigonometric functions of the sides of right triangles, one will often find it convenient to use the functions of an acute angle. Thus, functions of the acute angle B may be written as follows:

$$\begin{aligned}\sin \text{ angle B} &= \frac{AC}{AB} = \frac{\text{Opp Side}}{\text{Hyp}} = \frac{\text{Side } b}{\text{Side } c} \\ \cos \text{ angle B} &= \frac{BC}{AB} = \frac{\text{Adj Side}}{\text{Hyp}} = \frac{\text{Side } a}{\text{Side } c} \\ \tan \text{ angle B} &= \frac{AC}{BC} = \frac{\text{Opp Side}}{\text{Adj Side}} = \frac{\text{Side } b}{\text{Side } a} \\ \cot \text{ angle B} &= \frac{BC}{AC} = \frac{\text{Adj Side}}{\text{Opp Side}} = \frac{\text{Side } a}{\text{Side } b} \\ \sec \text{ angle B} &= \frac{AB}{BC} = \frac{\text{Hyp}}{\text{Adj Side}} = \frac{\text{Side } c}{\text{Side } a} \\ \csc \text{ angle B} &= \frac{AB}{AC} = \frac{\text{Hyp}}{\text{Opp Side}} = \frac{\text{Side } c}{\text{Side } b}\end{aligned}$$

By comparing the values of the functions of angle A and angle B, we find the following equations:

$$\begin{aligned}\sin A &= \cos B & \tan A &= \cot B & \sec A &= \csc B \\ \cos A &= \sin B & \cot A &= \tan B & \csc A &= \sec B\end{aligned}$$

Since angles A and B are complementary, the cosine, cotangent, and cosecant are called cofunctions of the sine, tangent and secant respectively. Conversely, we may state the following theorem: Any trigonometric function of an acute angle is equal to the corresponding cofunction of its complementary angle.

We can use this theorem to express any function of an angle greater than 45 degrees in terms of a function of an angle less than 45 degrees. For this reason, tables of values of the trigonometric functions need be computed only for angles from 0 to 45 degrees instead of from 0 to 90 degrees.

$$\begin{aligned}\text{Illustrations: (a) } \sin 76^\circ 43' &= \cos 90^\circ - 76^\circ 43' = \cos 13^\circ 17' \\ \text{(b) } \cot 51^\circ 28' 9'' &= \tan 90^\circ - 51^\circ 28' 9'' = \tan 38^\circ 31' 51''\end{aligned}$$

Right Triangles

Terrain analysts will use the functions of the right triangle most often for interpretation purposes. In any triangle, the sum of the interior angles is 180 degrees. If the triangle to be solved is a right triangle, one of the known parts in any case is the angle C; that is, C = 90 degrees, and A + B = 90 degrees. To solve a right triangle, therefore, we must find two sides or one side and an acute angle, using the formulas--

$$A + B = 90 \text{ degrees}$$

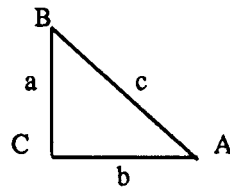
$$\begin{aligned}\sin \text{ angle A} &= \frac{\text{Opp Side}}{\text{Hyp}} = \frac{a}{c} \\ \cos \text{ angle A} &= \frac{\text{Adj Side}}{\text{Hyp}} = \frac{b}{c} \\ \tan \text{ angle A} &= \frac{\text{Opp Side}}{\text{Adj Side}} = \frac{a}{b}\end{aligned}$$

If two sides are given, we can find the sin of angle A from the above formulas involving the two given sides. We may then use another formula to find the remaining side, and then find angle B by subtracting angle A from 90 degrees.

If one side of an acute angle is given, we begin by finding the other acute angle. Then we select one of the trigonometric formulas containing an unknown side and solve for it.

Pythagorean Theorem

The Pythagorean theorem provides a method for finding the lengths of the sides of a right triangle and checking the trigonometric method, with the statement: The square of the hypotenuse of a right triangle is equal to the sum of the squares of the other two sides. Related to a right triangle labeled A, B, and C, as shown previously and reproduced here for convenience, the theorem may be stated as the formula



$$a^2 + b^2 = c^2$$

or

$$c^2 = a^2 + b^2$$

Note: In order to solve the formula, we must understand the solution to the square root function. The square root of a number is the result of a number multiplied by itself. For example, $2 \times 2 = 4$, so the square root of 4 is 2.

Degrees	Sines							Cosines
	0'	10'	20'	30'	40'	50'	60'	
0	0.00000	0.00291	0.00582	0.00873	0.01164	0.01454	0.01745	89
1	0.01745	0.02036	0.02327	0.02618	0.02908	0.03299	0.03490	88
2	0.03490	0.03781	0.04071	0.04362	0.04653	0.04943	0.05234	87
3	0.05234	0.05524	0.05814	0.06105	0.06395	0.06685	0.06976	86
4	0.06976	0.07266	0.07556	0.07846	0.08136	0.08426	0.08716	85
5	0.08716	0.09005	0.09295	0.09585	0.09874	0.10164	0.10453	84
6	0.10453	0.10742	0.11031	0.11320	0.11609	0.11898	0.12187	83
7	0.12187	0.12476	0.12764	0.13053	0.13341	0.13629	0.13917	82
8	0.13917	0.14205	0.14493	0.14781	0.15069	0.15356	0.15643	81
9	0.15643	0.15931	0.16218	0.16505	0.16792	0.17078	0.17365	80
10	0.17365	0.17651	0.17937	0.18224	0.18509	0.18795	0.19081	79
11	0.19081	0.19366	0.19652	0.19937	0.20222	0.20507	0.20791	78
12	0.20791	0.21076	0.21360	0.21644	0.21928	0.22212	0.22495	77
13	0.22495	0.22778	0.23062	0.23345	0.23627	0.23910	0.24192	76
14	0.24192	0.24474	0.24756	0.25038	0.25320	0.25601	0.25882	75
15	0.25882	0.26163	0.26443	0.26724	0.27004	0.27284	0.27564	74
16	0.27564	0.27843	0.28123	0.28402	0.28680	0.28959	0.29237	73
17	0.29237	0.29515	0.29793	0.30071	0.30348	0.30625	0.30902	72
18	0.30902	0.31178	0.31454	0.31730	0.32006	0.32282	0.32557	71
19	0.32557	0.32832	0.33106	0.33381	0.33655	0.33929	0.34202	70
20	0.34202	0.34475	0.34748	0.35021	0.35293	0.35565	0.35837	69
21	0.35837	0.36108	0.36379	0.36650	0.36921	0.37191	0.37461	68
22	0.37461	0.37730	0.37999	0.38268	0.38537	0.38805	0.39073	67
23	0.39073	0.39341	0.39608	0.39875	0.40142	0.40408	0.40674	66
24	0.40674	0.40939	0.41204	0.41469	0.41734	0.41998	0.42262	65
25	0.42262	0.42525	0.42786	0.43051	0.43313	0.43575	0.43837	64
26	0.43837	0.44098	0.44359	0.44620	0.44880	0.45140	0.45399	63
27	0.45399	0.45658	0.45917	0.46175	0.46433	0.46690	0.46947	62
28	0.46947	0.47204	0.47460	0.47716	0.47971	0.48226	0.48481	61
29	0.48481	0.48735	0.48989	0.49242	0.49495	0.49748	0.50000	60
30	0.50000	0.50252	0.50503	0.50754	0.51004	0.51254	0.51504	59
31	0.51504	0.51753	0.52002	0.52250	0.52498	0.52745	0.52992	58
32	0.52992	0.53238	0.53484	0.53730	0.53975	0.54220	0.54464	57
33	0.54464	0.54708	0.54951	0.55194	0.55436	0.55678	0.55919	56
34	0.55919	0.56160	0.56401	0.56641	0.56880	0.57119	0.57358	55
35	0.57358	0.57596	0.57833	0.58070	0.58307	0.58543	0.58779	54
36	0.58779	0.59014	0.59248	0.59482	0.59716	0.59949	0.60182	53
37	0.60182	0.60414	0.60645	0.60876	0.61107	0.61337	0.61566	52
38	0.61566	0.61795	0.62024	0.62251	0.62479	0.62706	0.62932	51
39	0.62932	0.63158	0.63383	0.63608	0.63832	0.64056	0.64279	50
40	0.64279	0.64501	0.64723	0.64945	0.65166	0.65386	0.65606	49
41	0.65606	0.65825	0.66044	0.66262	0.66480	0.66697	0.66913	48
42	0.66913	0.67129	0.67344	0.67559	0.67778	0.67987	0.68200	47
43	0.68200	0.68412	0.68624	0.68835	0.69046	0.69256	0.69466	46
44	0.69466	0.69675	0.69883	0.70091	0.70298	0.70505	0.70711	45
Sines	60'	50'	40'	30'	20'	10'	0'	Degrees
Cosines								

Degrees	Cosines							Sines
	0'	10'	20'	30'	40'	50'	60'	
0	1.00000	1.00000	0.99998	0.99996	0.99993	0.99989	0.99985	89
1	0.99985	0.99979	0.99973	0.99966	0.99958	0.99949	0.99939	88
2	0.99939	0.99929	0.99917	0.99905	0.99892	0.99878	0.99863	87
3	0.99863	0.99847	0.99831	0.99813	0.99795	0.99776	0.99756	86
4	0.99756	0.99736	0.99714	0.99692	0.99668	0.99644	0.99619	85
5	0.99619	0.99594	0.99567	0.99540	0.99511	0.99482	0.99452	84
6	0.99452	0.99421	0.99390	0.99357	0.99324	0.99290	0.99255	83
7	0.99255	0.99219	0.99182	0.99144	0.99106	0.99067	0.99027	82
8	0.99027	0.98986	0.98944	0.98902	0.98858	0.98814	0.98769	81
9	0.98769	0.98723	0.98676	0.98629	0.98580	0.98531	0.98481	80
10	0.98481	0.98430	0.98378	0.98325	0.98272	0.98218	0.98163	79
11	0.98163	0.98107	0.98050	0.97992	0.97934	0.97875	0.97815	78
12	0.97815	0.97754	0.97692	0.97630	0.97566	0.97502	0.97437	77
13	0.97437	0.97371	0.97304	0.97237	0.97169	0.97100	0.97030	76
14	0.97030	0.96959	0.96887	0.96815	0.96742	0.96667	0.96593	75
15	0.96593	0.96517	0.96440	0.96363	0.96285	0.96206	0.96126	74
16	0.96126	0.96046	0.95964	0.95882	0.95799	0.95715	0.95630	73
17	0.95630	0.95545	0.95459	0.95372	0.95284	0.95195	0.95106	72
18	0.95106	0.95015	0.94924	0.94832	0.94740	0.94646	0.94552	71
19	0.94552	0.94457	0.94361	0.94264	0.94167	0.94068	0.93969	70
20	0.93969	0.93869	0.93769	0.93667	0.93565	0.93462	0.93358	69
21	0.93358	0.93253	0.93148	0.93042	0.92935	0.92827	0.92718	68
22	0.92718	0.92609	0.92499	0.92388	0.92276	0.92164	0.92050	67
23	0.92050	0.91936	0.91822	0.91706	0.91590	0.91472	0.91355	66
24	0.91355	0.91236	0.91116	0.90996	0.90875	0.90753	0.90631	65
25	0.90631	0.90507	0.90383	0.90259	0.90133	0.90007	0.89879	64
26	0.89879	0.89752	0.89623	0.89493	0.89363	0.89232	0.89101	63
27	0.89101	0.88968	0.88835	0.88701	0.88566	0.88431	0.88295	62
28	0.88295	0.88158	0.88020	0.87882	0.87743	0.87603	0.87462	61
29	0.87462	0.87321	0.87178	0.87036	0.86892	0.86748	0.86603	60
30	0.86603	0.86457	0.86310	0.86163	0.86015	0.85866	0.85717	59
31	0.85717	0.85567	0.85416	0.85264	0.85112	0.84959	0.84805	58
32	0.84805	0.84650	0.84495	0.84339	0.84182	0.84025	0.83867	57
33	0.83867	0.83708	0.83549	0.83389	0.83228	0.83066	0.82904	56
34	0.82904	0.82741	0.82577	0.82413	0.82248	0.82082	0.81915	55
35	0.81915	0.81748	0.81580	0.81412	0.81242	0.81072	0.80902	54
36	0.80902	0.80730	0.80558	0.80386	0.80212	0.80038	0.79864	53
37	0.79864	0.79688	0.79512	0.79335	0.79158	0.78980	0.78801	52
38	0.78801	0.78622	0.78442	0.78261	0.78079	0.77897	0.77715	51
39	0.77715	0.77531	0.77347	0.77162	0.76977	0.76791	0.76604	50
40	0.76604	0.76417	0.76229	0.76041	0.75851	0.75661	0.75471	49
41	0.75471	0.75280	0.75088	0.74896	0.74703	0.74509	0.74314	48
42	0.74314	0.74120	0.73924	0.73728	0.73531	0.73333	0.73135	47
43	0.73135	0.72937	0.72737	0.72537	0.72337	0.72136	0.71934	46
44	0.71934	0.71732	0.71529	0.71325	0.71121	0.70916	0.70711	45
Cosines	60'	50'	40'	30'	20'	10'	0'	Degrees
Sines								

Table 10-4 Natural Trigonometric Functions

Degrees	Tangents							Cotangents
	0°	10°	20°	30°	40°	50°	60°	
0	0.00000	0.00291	0.00582	0.00873	0.01164	0.01455	0.01746	89
1	0.01746	0.02036	0.02328	0.02619	0.02910	0.03201	0.03492	88
2	0.03492	0.03783	0.04075	0.04366	0.04658	0.04949	0.05241	87
3	0.05241	0.05533	0.05824	0.06116	0.06408	0.06700	0.06993	86
4	0.06993	0.07285	0.07578	0.07870	0.08163	0.08456	0.08749	85
5	0.08749	0.09042	0.09335	0.09629	0.09923	0.10216	0.10510	84
6	0.10510	0.10805	0.11099	0.11394	0.11688	0.11983	0.12278	83
7	0.12278	0.12574	0.12869	0.13165	0.13461	0.13758	0.14054	82
8	0.14054	0.14351	0.14648	0.14945	0.15243	0.15540	0.15838	81
9	0.15838	0.16137	0.16435	0.16734	0.17033	0.17333	0.17633	80
10	0.17633	0.17933	0.18233	0.18534	0.18835	0.19136	0.19438	79
11	0.19438	0.19740	0.20042	0.20345	0.20648	0.20952	0.21256	78
12	0.21256	0.21560	0.21864	0.22169	0.22475	0.22781	0.23087	77
13	0.23087	0.23393	0.23700	0.24008	0.24316	0.24624	0.24933	76
14	0.24933	0.25242	0.25552	0.25862	0.26172	0.26483	0.26795	75
15	0.26795	0.27107	0.27419	0.27732	0.28046	0.28360	0.28675	74
16	0.28675	0.28990	0.29305	0.29621	0.29938	0.30255	0.30573	73
17	0.30573	0.30891	0.31210	0.31530	0.31850	0.32171	0.32492	72
18	0.32492	0.32814	0.33136	0.33460	0.33783	0.34108	0.34433	71
19	0.34433	0.34758	0.35085	0.35412	0.35740	0.36068	0.36397	70
20	0.36397	0.36727	0.37057	0.37388	0.37720	0.38053	0.38386	69
21	0.38386	0.38721	0.39055	0.39391	0.39727	0.40065	0.40403	68
22	0.40403	0.40741	0.41081	0.41421	0.41763	0.42105	0.42447	67
23	0.42447	0.42791	0.43136	0.43481	0.43828	0.44175	0.44523	66
24	0.44523	0.44872	0.45222	0.45573	0.45924	0.46277	0.46631	65
25	0.46631	0.46985	0.47341	0.47698	0.48055	0.48414	0.48773	64
26	0.48773	0.49134	0.49495	0.49858	0.50222	0.50587	0.50953	63
27	0.50953	0.51320	0.51688	0.52057	0.52427	0.52798	0.53171	62
28	0.53171	0.53545	0.53920	0.54296	0.54674	0.55051	0.55431	61
29	0.55431	0.55812	0.56194	0.56577	0.56962	0.57348	0.57735	60
30	0.57735	0.58124	0.58513	0.58905	0.59297	0.59691	0.60086	59
31	0.60086	0.60483	0.60881	0.61280	0.61681	0.62083	0.62487	58
32	0.62487	0.62892	0.63299	0.63707	0.64117	0.64528	0.64941	57
33	0.64941	0.65355	0.65771	0.66189	0.66608	0.67028	0.67451	56
34	0.67451	0.67875	0.68301	0.68728	0.69157	0.69588	0.70021	55
35	0.70021	0.70455	0.70891	0.71329	0.71769	0.72211	0.72654	54
36	0.72654	0.73100	0.73547	0.73996	0.74447	0.74900	0.75355	53
37	0.75355	0.75812	0.76272	0.76733	0.77196	0.77661	0.78129	52
38	0.78129	0.78598	0.79070	0.79544	0.80020	0.80498	0.80978	51
39	0.80978	0.81461	0.81946	0.82434	0.82923	0.83415	0.83910	50
40	0.83910	0.84407	0.84906	0.85408	0.85912	0.86419	0.86929	49
41	0.86929	0.87441	0.87955	0.88473	0.88992	0.89515	0.90040	48
42	0.90040	0.90569	0.91099	0.91633	0.92170	0.92709	0.93252	47
43	0.93252	0.93797	0.94345	0.94896	0.95451	0.96008	0.96569	46
44	0.96569	0.97133	0.97700	0.98270	0.98843	0.99420	1.00000	45
Tangents	60°	50°	40°	30°	20°	10°	0°	Degrees
Cotangents								

Degrees	Cotangents							Tangents
	0°	10°	20°	30°	40°	50°	60°	
0	∞	343.77371	171.88540	114.58865	85.93979	68.75009	57.28996	89
1	57.28996	49.10388	42.96408	38.18846	34.36777	31.24158	28.63625	88
2	28.63625	26.43160	24.54176	22.90377	21.47040	20.20555	19.08114	87
3	19.08114	18.07498	17.16934	16.34986	15.60479	14.92442	14.30067	86
4	14.30067	13.72674	13.19630	12.70621	12.25051	11.82617	11.43005	85
5	11.43005	11.05943	10.71191	10.38540	10.07803	9.78817	9.51436	84
6	9.51436	9.25530	9.00983	8.77689	8.55555	8.34496	8.14435	83
7	8.14435	7.95302	7.77035	7.59575	7.42871	7.26873	7.11537	82
8	7.11537	6.96823	6.82694	6.69116	6.56055	6.43484	6.31375	81
9	6.31375	6.19703	6.08444	5.97576	5.87080	5.76937	5.67128	80
10	5.67128	5.57638	5.48451	5.39552	5.30928	5.22566	5.14455	79
11	5.14455	5.06584	4.98940	4.91516	4.84300	4.77286	4.70463	78
12	4.70463	4.63825	4.57363	4.51071	4.44942	4.38969	4.33148	77
13	4.33148	4.27471	4.21933	4.16530	4.11256	4.06107	4.01078	76
14	4.01078	3.96165	3.91364	3.86671	3.82083	3.77595	3.73205	75
15	3.73205	3.68909	3.64705	3.60588	3.56557	3.52609	3.48741	74
16	3.48741	3.44951	3.41236	3.37594	3.34023	3.30521	3.27085	73
17	3.27085	3.23714	3.20406	3.17159	3.13972	3.10842	3.07768	72
18	3.07768	3.04749	3.01783	2.98869	2.96004	2.93189	2.90421	71
19	2.90421	2.87700	2.85023	2.82391	2.79802	2.77254	2.74748	70
20	2.74748	2.72281	2.69853	2.67462	2.65109	2.62791	2.60509	69
21	2.60509	2.58261	2.56046	2.53865	2.51715	2.49597	2.47509	68
22	2.47509	2.45451	2.43422	2.41421	2.39449	2.37504	2.35585	67
23	2.35585	2.33696	2.31826	2.29984	2.28167	2.26374	2.24604	66
24	2.24604	2.22857	2.21132	2.19430	2.17749	2.16090	2.14451	65
25	2.14451	2.12832	2.11233	2.09654	2.08094	2.06553	2.05030	64
26	2.05030	2.03526	2.02039	2.00569	1.99116	1.97680	1.96261	63
27	1.96261	1.94858	1.93470	1.92089	1.90741	1.89400	1.88073	62
28	1.88073	1.86760	1.85462	1.84177	1.82907	1.81649	1.80405	61
29	1.80405	1.79174	1.77955	1.76749	1.75556	1.74375	1.73205	60
30	1.73205	1.72047	1.70901	1.69766	1.68643	1.67530	1.66428	59
31	1.66428	1.65337	1.64256	1.63185	1.62125	1.61074	1.60033	58
32	1.60033	1.59002	1.57981	1.56969	1.55966	1.54972	1.53987	57
33	1.53987	1.53010	1.52043	1.51084	1.50133	1.49190	1.48256	56
34	1.48256	1.47330	1.46411	1.45501	1.44598	1.43703	1.42815	55
35	1.42815	1.41934	1.41061	1.40195	1.39336	1.38484	1.37638	54
36	1.37638	1.36800	1.35968	1.35142	1.34323	1.33511	1.32704	53
37	1.32704	1.31904	1.31110	1.30323	1.29541	1.28764	1.27994	52
38	1.27994	1.27230	1.26471	1.25717	1.24969	1.24227	1.23490	51
39	1.23490	1.22758	1.22031	1.21310	1.20593	1.19882	1.19175	50
40	1.19175	1.18474	1.17777	1.17085	1.16398	1.15715	1.15037	49
41	1.15037	1.14363	1.13694	1.13029	1.12369	1.11713	1.11061	48
42	1.11061	1.10414	1.09770	1.09131	1.08496	1.07864	1.07237	47
43	1.07237	1.06613	1.05994	1.05378	1.04766	1.04158	1.03553	46
44	1.03553	1.02952	1.02355	1.01761	1.01170	1.00583	1.00000	45
Cotangents	60°	50°	40°	30°	20°	10°	0°	Degrees
Tangents								

Table 10-4 Natural Trigonometric Functions

Mensural Conversions

Appendix A

Multiply	By	To Obtain	Multiply	By	To Obtain
Acres	40.47	Ares	Feet	30.48	Centimeters
Acres	4,047	Centares	Feet	0.1667	Fathoms
Acres	10	Square chains	Feet	0.3048	Meters
Acres	43,560	Square Feet	Feet per Minute	0.01136	Miles per Hour
Acres	4,840	Square Yards	Feet per Second	0.5921	Knots
Ares	0.02471	Acres	Feet per Second	18.288	Meters per Minute
Ares	100	Centares	Feet per Second	0.6818	Miles per Hour
Ares	1,076	Square Feet	Furlongs	10	Chains
Ares	119.6	Square Yards	Furlongs	660	Feet
Barrels (U.S., dry)	3.281	Bushels	Furlongs	40	Rods
Barrels (U.S., liquid)	4.21	Cubic Feet	Furlongs	220	Yards
Barrels (U.S., liquid)	31.5	Gallons	Gallons (British)	4,546.1	Cubic Centimeters
Board Feet (1' x 1' x 1')	144	Cubic inches	Gallons (British)	0.1605	Cubic Feet
Cable lengths (U.S.)	120	Fathoms	Gallons (British)	277.274	Cubic Inches
Cable lengths (U.S.)	720	Feet	Gallons (British)	1.2009	Gallons (U.S.)
Cable lengths (U.S.)	240	Yards	Gallons (British)	4.546	Liters
Centares	10.76	Square feet	Gallons (British)	4	Quarts (British)
Centares	1.196	Square Yards	Gallons (U.S.)	0.03175	Barrels (liquid, U.S.)
Centimeters	0.3937	Inches	Gallons (U.S.)	3,785.4	Cubic Centimeters
Cubic Centimeters	0.06102	Cubic Inches	Gallons (U.S.)	0.13368	Cubic Feet
Chains	66	Feet	Gallons (U.S.)	231	Cubic Inches
Chains	100	Links	Gallons (U.S.)	0.8327	Gallons (British)
Chains	4	Rods	Gallons (U.S.)	3.785	Liters
Cubic Feet	1,728	Cubic Inches	Gallons (U.S.)	4	Quarts (U.S.)
Cubic Feet	0.02832	Cubic Meters	Grams	15.43	Grains
Cubic Feet	0.03704	Cubic Yards	Grams	0.001	Kilograms
Cubic Feet	6.229	Gallons (British)	Grams	1,000	Milligrams
Cubic Feet	7.481	Gallons (U.S.)	Grams	0.03527	Ounces (avoir-dupois)
Cubic Feet	28.316	Liters			
Cubic Inches	16.39	Cubic Centimeters	Hands	10.16	Centimeters
Cubic Inches	0.0005787	Cubic Feet	Hands	4	Inches
Cubic Inches	0.003606	Gallons (British)	Hectares	2.471	Acres
Cubic Inches	0.004329	Gallons (U.S.)	Hectares	100	Ares
Cubic Inches	0.01639	Liters	Hectoliters	0.1	Cubic Meters
Cubic Meters	35.31	Cubic Feet	Hectoliters	26.417	Gallons (U.S.)
Cubic Meters	1.308	Cubic Yards	Hectoliters	100	Liters
Cubic Yards	27	Cubic Feet	Hogsheads	2	Barrels (Liquid, U.S.)
Cubic Yards	0.7646	Cubic Meters			
Cubic Yards	764.6	Liters	Hogsheads (U.S.)	63	Gallons (U.S.)
Degrees (C.)+ 17.8	1.8	Degrees (F.)	Hundredweights	0.508	Quintals (metric)
Degrees (F.) -32	0.5556	Degrees (C.)	Inches	72	Points
Degrees	0.01745	Radians	Inches	6	Picas
Fathoms	0.00833	Cable Lengths (U.S.)	Inches	6	Ems
Fathoms	6	Feet	Inches	12	Ens
Fathoms	1.8288	Meters	Inches	2.54	Centimeters

Multiply	By	To Obtain	Multiply	By	To Obtain
Inches	0.0833	Feet	Miles, Nautical	6,076.1	Feet
Inches	1,000	Mils	Miles, Nautical	72,963	Inches
Inches	0.0277	Yards	Miles, Nautical	1.8532	Kilometers
Inches of Mercury	0.49131	Pounds per Square Inch	Miles, Nautical	1,853.2	Meters
Kilograms	1,000	Grams	Miles, Nautical	1.1508	Miles, Statute
Kilograms	2.2046	Pounds (Avoirdupois)	Miles, Nautical	1	Minutes of Latitude
Kiloliters	1	Cubic Meters	Miles, Nautical	2,026.8	Yards
Kiloliters	1.308	Cubic Yards	Miles per Hour (Statute)	88	Feet per Minute
Kiloliters	264.18	Gallons (U.S.)	Miles per Hour (Statute)	1.467	Feet per Second
Kiloliters	1,000	Liters	Miles per Hour (Statute)	0.8684	Knots
Kilometers	4.557	Cable Lengths	Miles, Statute	7.33	Cable Lengths
Kilometers	3,280.8	Feet	Miles, Statute	5,280	Feet
Kilometers	39,370	Inches	Miles, Statute	8	Furlongs
Kilometers	1,000	Meters	Miles, Statute	63,360	Inches
Kilometers	0.5396	Miles, Nautical	Miles, Statute	1.6093	Kilometers
Kilometers	0.62137	Miles, Statute	Miles, Statute	1,609.3	Meters
Kilometers	1,093.6	Yards	Miles, Statute	0.8689	Miles, Nautical
Knots	1.1516	Statute Miles per Hour	Miles, Statute	1,760	Yards
Knots	1.688	Feet per Second	Millier (See Tons - Metric)		
Leagues, Nautical	25.33	Cable Lengths	Milliradians	206.265	Seconds of Arc
Leagues, Nautical	5.5597	Kilometers	Mils	0.001	Inches
Leagues, Nautical	3	Miles, Nautical	Myriameters	10	Kilometers
Leagues, Statute	4.8280	Kilometers	Ounces (avoirdupois)	28.3495	Grams
Leagues, Statute	3	Miles, Statute	Pint (Liquid, U.S.)	4	Gills (U.S.)
Links	7.92	Inches	Pint (Liquid, Br.)	4	Gills (British)
Liters	1,000	Cubic Centimeters	Pint (Liquid, Br.)	0.56825	Liters
Liters	61.025	Cubic Inches	Pint (Liquid, U.S.)	0.4732	Liters
Liters	0.21998	Gallons (British)	Pounds (avoirdupois)	7,000	Grains
Liters	0.26418	Gallons (U.S.)	Pounds (avoirdupois)	453.59	Grams
Liters	0.8799	Quarts (British)	Pounds (avoirdupois)	0.4536	Kilograms
Liters	0.908	Quarts (U.S., dry)	Pounds (avoirdupois)	16	Ounces
Liters	1.0567	Quarts (Liquid, U.S.)	Pounds (avoirdupois)	1.2153	Pounds (troy)
Meters	100	Centimeters	Pounds (avoirdupois)	0.8229	Pounds (avoirdupois)
Meters	0.001	Kilometers	Pounds per Square Inch	2.03537	Inches of Mercury
Meters	1.0936	Yards	Quart (British)	1.1365	Liters
Meters	3.281	Feet	Quart (British)	2	Pints (British)
Meters	39.37	Inches	Quart (Liquid, U.S.)	0.9463	Liters
Meters	1,000	Millimeters	Quart (U.S.)	2	Pints (U.S.)
Meters	1.0936	Yards	Quintals (Metric)	1.97	Hundredweights
Meters per Minute	0.0547	Feet per Second	Quintals (Metric)	100	Kilograms
Meters per Second	2.237	Miles per Hour			
Microns	0.001	Millimeters			
Miles, Nautical	8.44	Cable Lengths			

Multiply	By	To Obtain	Multiply	By	To Obtain
Radians	57.30	Degrees	Square Miles, Statute	259	Hectares
Rods	16.3	Feet	Square Miles, Statute	2.59	Square Kilometers
Rods	25	Links	Square Yards	0.8362	Centares
Square Centimeters	0.1550	Square Inches	Square Yards	9	Square Feet
Square Feet	0.0929	Centares	Square Yards	1,296	Square Inches
Square Feet	929	Square Centimeters	Tons (Long)	1.016	Metric Tons
Square Feet	144	Square Inches	Tons (Long)	2,240	Pounds (Avoir- dupois)
Square Feet	0.1111	Square Yards	Tons (Metric)	1,000	Kilograms
Square Inches	6.452	Square Centimeters	(Millier)		
Square Inches	0.006944	Square Feet	Tons (Metric)	2,204.6	Pounds (Avoir- dupois)
Square Kilometers	100	Hectares	(Millier)		
Square Kilometers	0.3861	Square Miles (Statute)	Tons (Short)	0.9072	Metric Tons
Square Meters (See Centares)			Tons (Short)	2,000	Pounds (Avoir- dupois)
Square Miles, Statute	640	Acres	Yards	91.44	Centimeters
Square Miles, Statute	25,900	Ares	Yards	0.9144	Meters

To understand the interactions between weather and terrain and to work effectively with the staff weather officer (SWO), the terrain analyst must have a basic knowledge of weather phenomena and weather support procedures. This appendix discusses weather and weather-related factors that may affect military operations.

In addition to terrain, the battlefield environment includes atmosphere (weather), battle-induced contaminants (man-made weather), background signatures, and illumination (both natural and man-made). The terrain analyst, intelligence analyst, and United States Air Force weather personnel work together to integrate these environmental factors with terrain to determine their net effects on mobility and weapons usage. While weather effects on personnel and tactics are specifically an intelligence function, the same environmental phenomena also affect topographic engineer concerns. Therefore, analysis of factors should be a joint effort between topographic engineer, intelligence, and USAF weather personnel. The analyst should have a general knowledge of weather phenomena and its interaction with terrain. The analyst should also know how to get and use weather information. Since equipment and procedures change frequently, analysts should get specific information from the unit involved about effects of the weather on unit equipment and operations.

TYPES OF WEATHER INFORMATION

The three groups of weather information are observations, forecasts, and climatology. Units use observations and forecasts in support of current operations, while they use climatology for long-range planning.

Weather Observations

Weather observations are reports of actual weather conditions existing at a specific location at a given time. Observations are determined visually, with instruments, or both. Terrain analysts will base much of their analysis on current weather observations, since weather information can change very quickly. For this reason, units must also keep observations current. The SWO generally receives weather observations in codes comprised of abbreviations, numbers, letters, and symbols. Codes are used to simplify and speed transmission, not because of classification. The USAF weather personnel can explain the codes used in a given area.

The SWO can obtain observations taken by USAF weather observers, Army personnel in the Forward Area Limited Observation Program (FALOP), artillery meteorology (ARTYMET), and domestic and foreign weather services.

Unfortunately, weather observations are not always available, nor do they always contain the weather parameters of interest. However, the weather forecaster can forecast the present weather at a given location for which observations are not available. This forecast is called a "nowcast"; the complexity of the meteorological situation and the forecaster's knowledge of past conditions at that location determine its accuracy.

Weather Forecasts

SWOs usually base weather support to current operations on observed current weather and on weather forecasts. Weather forecasts are predictions of future weather for a specific period at a specific location or area. Forecast accuracy depends on the time range being forecast, the complexity of the meteorological situation, and the amount and quality of data available. Forecasts for longer time ranges are more general in nature and less accurate than those for 24 hours or less. Forecasts longer than a week are rarely very accurate because of our limited knowledge of how the weather operates. Thus, forecasters usually base long-range forecasts on climatology, a statistical summary of usual weather conditions for a given location and time of the year.

When possible, analysts should present observed weather along with forecast weather information. This lends credence to the forecast and gives the commander a sense of the reliability of the forecast. Weather forecasting is not an exact science, and not all forecasts will be accurate. The SWO will be more confident in the forecast in some situations than in others. Analysts should keep in contact with the SWO in case the forecast changes and should check the progress of the weather observations for their area of operations.

Climatology

Climate refers to the characteristic weather for a given place or area over a specified time. It is usually represented by statistics of weather conditions such as mean values, extreme values, and probability distributions. Commanders use climatology for planning upcoming operations. The SWO should have climatological information for the unit area. If not, he can get it from higher USAF channels. If the unit does not have an SWO, analysts can order climatology data directly from the Air Force under procedures in AR 115-1. Response time depends on whether the data exists and whether it exists in the format needed. Often it will be better to change the request so it can be filled with immediately available data than to demand specific computer-formulated data, which could take more time to get.

Often information from standard climatological summaries will be satisfactory, and units can get it quickly. Examples of such information include normal daily maximum and minimum surface temperatures and normal monthly rainfall amounts. If the supported unit has specific weather sensitivities not covered in standard climatological summaries, USAFETAC can formulate statistics to meet those needs. For example, if a unit has a weapon system that is limited by surface winds of 20 knots or more, the analyst can request statistics on the monthly frequencies of such winds and statistics indicating how often particular hours of the day have winds of 20 knots or more.

Two problems arise from using climatology. First, the specific information may not be available. Observations at that location may never have been taken, or the available observations may not include the specific parameter. Consequently, there is no data base upon which to formulate statistics. Units can usually overcome this shortage by the SWO or USAFETAC estimating weather conditions from nearby stations for which data is available.

Second, too much data is sometimes available. This can create a difficult situation, in which the analyst must be careful not to swamp a commander with useless statistics and unnecessary

detail. Thus, the analyst must know which weather conditions will affect the unit's operations and work with the SWO to present a concise summary of pertinent climatology.

WEATHER ELEMENTS

This section describes the application of the more common weather elements to terrain analysis. It contains the basic knowledge needed to work effectively with WETM and intelligence personnel. The information here is not complete; specific information about weather effects on the equipment used by the supported unit must come from that unit itself. Weather effects on terrain can be complex; unfortunately, few tactical decision aids are available. Until further procedures are available, much of the application of weather information will depend on the combined judgement and experience of the terrain analyst, SWO, and intelligence analyst.

Temperature

Temperature, alone or in combination with other weather elements, impacts on many activities. Extremes of temperature are a discomfort to personnel and can affect equipment and weapons systems. The difference between the temperature of a target and its background is critical to weapons using infrared sighting devices. This section outlines some factors to remember in using temperature information.

Surface temperatures in North America are generally measured in degrees Fahrenheit (°F); elsewhere they are reported in degrees Celsius (°C). Analysts always report upper air temperatures in degrees Celsius. Conversion between the two temperature scales is by the following formulas:

$$F=(9/5x C) +32$$

$$C=5/9x (F-32)$$

Temperature is normally measured at about 5 feet above a grassy surface, with the thermometer shielded from direct sunlight and precipitation. This temperature is not necessarily the same as the temperature just above the surface of the ground. The temperature at grass level can be several degrees higher during the day and several degrees cooler at night. Temperature is dependent on topography, with higher elevations generally being cooler. However, since cold air is denser than warm air, cold air tends to flow into lower areas on nights with light winds.

Analysts must remember that objects are not necessarily the same temperature as the air. Metal objects exposed to sunlight, for example, tend to be hotter than air temperature, due to their absorption of solar radiation. At night they tend to be cooler than the air, because they lose their heat more rapidly by radiation. This can be very important to infrared sensing devices.

Windchill equivalent temperature (WCET), often simply called wind chill, is an approximation of the combined effect of temperature and wind on the exposed human body. Analysts must remember that the air movement causing windchill comes not only from wind but from any movement of the body relative to the air. Riding in an open truck moving at 20 mph in a 10-mph headwind gives a windchill equivalent to a 30 miles per hour wind. Windchill does not apply to equipment. For example, with a -10° F temperature, a battery will perform the same in calm conditions as in a 20-mph wind.

Frozen ground can be critical to trafficability. Frost depth depends on soil type, soil moisture content, type of ground cover, and recent temperature history at the site. Given the same soil and weather conditions, increased soil moisture (up to near the point of saturation)

will cause frost to penetrate deeper and faster. Bare soil will normally also freeze faster and deeper than sod-covered areas. Snow cover is an excellent insulator and can cause depth of frost to be shallower than in areas without snow cover. Usually, few observations of frost depth will be available. Furthermore, frost depth cannot be forecast now. Analysts will probably have to depend on their own observations of frost depth.

Temperature climatology information is usually readily available. It is important not to be misled by mean temperature information; extreme temperatures are most important. While there can be no set format for presenting temperature climatology, analysts and SWOs should consider the following example, which gives monthly data on mean daily maximums, mean daily minimums, monthly extremes, and an indication of frequency of some critical values by giving statistics of how many days those values are exceeded:

CATEGORIES*	JAN	FEB	MAR	APR	MAY	JUN	JUL	AUG	SEP	OCT	NOV	DEC
Extreme maximum	45	48	60	78	92	98	104	104	92	70	60	48
Mean daily maximum	22	32	49	60	75	92	98	98	83	64	43	33
Mean daily minimum	2	11	29	40	55	72	78	80	63	44	24	11
Extreme minimum	128	-22	-2	15	28	53	55	55	26	14	-2	-13
Number of days with temperature less than or equal to 32	31	28	23	5	2	0	0	0	4	14	24	27

* All categories are in degrees fahrenheit

Table B-1. Sample temperature data

Wind

Wind direction is always recorded as the direction *from which* the wind is blowing. Direction is in the sixteen points of the compass or in tens of degrees with north being 360°; east, 90°; south, 180°; and west, 270°. Wind speed is usually in knots (nautical miles per hour, with a nautical mile being 6,076 feet), miles per hour, or meters per second. See Appendix A for conversion tables.

A gust is a rapid fluctuation in wind speed with a variation of 10 knots or more between peak and lull. For example, if the wind were blowing out of the north northeast at a mean speed of 20 knots with gusts to 40 knots, it would be recorded as 030/20G40.

Gust spread is a measurement of wind speed fluctuation normally used only for aircraft operations. The gust spread is the instantaneous difference between peak wind speed and lull wind speed. Since the lull speed is not necessarily the same as the mean speed, the gust spread in the above example could be more than 20 knots.

Wind is highly dependent on terrain and can vary considerably over a few hundred meters. When forecasting for a large area, weather forecasters try to forecast the highest wind condition over that area. Sheltered areas will naturally experience lower wind speeds.

Analysts try to identify wind patterns not only by the general weather situation but also by any influencing terrain factors. Sea coasts and mountainous regions can have unique wind regimes. Analysts and SWOs must especially be aware of narrow mountain gaps that may funnel winds and cause locally high wind speeds.

Wind can act in combination with other weather phenomena. It raises dust which in turn reduces visibility. A very light wind can make fog more dense, but higher winds will disperse fog. Wind breaks temperature inversions. It also speeds the drying of ground and can improve trafficability.

Be careful when examining climatology of wind. Prevailing wind direction is the wind direction that predominates over a given period and is a useful statistic. However, mean wind speed over a period can be very misleading. It could be very windy during daylight hours but almost calm at night and the resulting mean wind speed would be low. However, higher wind speeds during the day could adversely affect operations. Analysts must try to get information on the frequency of occurrence of winds above the critical values for their unit.

Precipitation

Precipitation is very important to trafficability. The effect depends on the type and amount of precipitation, the soil type, surface slope, type and amount of vegetation cover, and soil moisture content before the precipitation fell. Because of this complexity, exact rules are not given. Table 6-3 lists dry and wet season rating cone indices (RCIs) for various USCS soil types. However, the decision to use dry or wet values is, at present, up to the analyst's judgement. Light showers seldom affect trafficability. They may even improve it over sand. However, moderate or greater rain will degrade it.

Aerial and Ground Imagery Sources

Appendix C

AERIAL IMAGERY SOURCES

Federal Agencies

Aerial Photography Field Office
2222 West 2300 south
P.O. Box 30010
Salt Lake City, UT 84125

Agricultural Stabilization and Conservation Service
Department of Agriculture
Western Laboratory
2505 Parleys Way
Salt Lake City, UT 84109 (Source for all states)

Defense Intelligence Agency
ATTN: DIAAP-10
Washington survey photography held by DMAHTC
6500 Brooks Lane
Washington, DC 20408

Bureau of Land Management
Department of Interior
Washington, DC 20408

Cartographic Archives Division
National Archives (GSA)
Washington, DC 20408

EROS Data Center
U.S. Geological Survey
Sioux Falls, SD 57198

National Cartographic Information Center (Headquarters)
Geological Survey
Department of Interior
Reston, VA 22090

NCIC-Mid-Continent
USGS, 1400 Independence Rd
Rolla, MO 65401

NCIC-Rocky Mountain
USGS, Topographic Division
Stop 510, BOX 25046
Denver Federal Center
Denver, CO 80225

NCIC-Western
USGS, 345 Middlefield Rd.
Menlo Park, CA 94025
National Ocean Survey
Department of Commerce
Washington Science Center
Rockville, MD 20852

Soil Conservation Service
Department of Agriculture
Federal Center Building
East-West Highway and Belcrest Rd.
Hyattsville, MD 20781

Tennessee Valley Authority
Maps and Surveys Branch
210 Haney Building
Chattanooga, TN 37401

Technology Application Center
University of New Mexico, Code 11
Albuquerque, NM 87131

FOREST SERVICE PHOTOGRAPHY, EASTERN US

Chief Forest Service
US Department of Agriculture
Washington, DC 20250

FOREST SERVICE PHOTOGRAPHY, WESTERN US

Region

- 1 Federal Building, Missoula, MT 59801
- 2 Federal Center, Building 85, Denver, CO 80025
- 3 Federal Center, 517 Gold Ave. SW, Albuquerque, NM 87101
- 4 Forest Service Building, Ogden, UT 84403
- 5 630 Sansome St., San Francisco, CA 94111
- 6 P.O. Box 8623, Portland, OR 97208
- 10 Regional Forester, U.S. Forest Service, P.O. Box 1628,
Juneau, AL 99801

NATIONAL AERONAUTICS AND SPACE ADMINISTRATION (NASA)

EROS Data Center
User Services Section
Sioux Falls, SD 57198
Phone (605) 594-6151
FTS 784-7151

Technology Applications Center
University of New Mexico
Albuquerque, NM 87131
Phone (505) 277-3622

Media Services Branch
Still Photography Library
NASA/Johnson Space Center
P.O. Box 58425, Mail Code AP3
Houston, TX 77258-8425
Phone (713)483-4231

US GEOLOGICAL SURVEY

Western Center
Box 25286 Federal Center, Bldg. 41
Denver, CO 80225

Mid-Continent Center
1400 Independence Road
Rolla, MO 65401

Eastern Center
United States Dept. of the Interior
Geological Survey
Reston, VA 22092

State Agencies

Arizona Highway Department
Administrative Services Division
206 South 17th Avenue
Phoenix, AZ 85007

State of Arkansas Highway Department
Surveys, 9500 New Denton Highway
P.O. Box 2261
Little Rock, AK

Illinois Department of Transportation
2300 South - 31st Street
Springfield, IL 62734

Indiana Highway Department
608 State Office Building
Indianapolis, IN 46204

Southeast Michigan
Council of Governments
1249 Washington Boulevard
Detroit, MI 49226

State of Nebraska
Department of Roads
14th & Burnham Streets
Lincoln, NE 68502

State of Ohio
Department of Highways
Columbus, OH 43216

Oregon State Highway Division
Salem, OR 97310

Virginia Department of Highways
Location and Design Engineer
1401 East Broad Street
Richmond, VA 23219

State of Washington
Department of Natural Resources
600 North Capital Way
Olympia, WA 98501

Southeastern Wisconsin Regional Planning Commission
916 North East Avenue
Waukesha, WI 53186

Wisconsin Department of Transportation
Engineering Services
4802 Sheboygan Avenue
Madison, WI 53702

NOTE: This list is not all-inclusive. Most states have departments of transportation, departments of natural resources, or agricultural management departments. These agencies are good sources for photography. Coordination must be made with local state or county offices to aid in the procurement process.

Commerical Firms

Aerial Data Service
10338 East 21st Street
Tulsa, OK 74129

Aero Service Corporation
4219 Van Kirk Street
Philadelphia, Pennsylvania 19135

Air Photographic Inc.
P.O. Box 786
Purcellville, VA 23132

Alster and Associates, Inc.
6135 Kansas Avenue, NE
Washington, DC 20011

Ammann International Base Map & Air Photo Library
223 Tenth Street
San Antonio, TX 78215

Burlington Northern Inc.
650 Central Building
Seattle, Washington 98104

Cartwright Aerial Surveys Inc.
Executive Airport
6151 Freeport Boulevard
Sacramento, California 95822

Fairchild Aeromaps Inc.
14437 North 73th Street
Scottsdale, Arizona 85254

Grumman Ecosystems Corp.
Bethpage, NY 11714

Henderson Aerial Surveys Inc.
5125 West Broad Street
Columbus, Ohio 43228

H. G. Chickening, Jr.
Consulting Photogrammetrist, Inc.
P.O. Box 2767
1190 West 7th Avenue
Eugene, Oregon 97402

L. Robert Kimball
615 West Highland Avenue
Ebensburg, Pennsylvania 15931

Lockwood, Kessler & Bartlett, Inc.
One Aerial Way
Syosset, NY 11791

Mark Hurd Aerial Surveys, Inc.
345 Pennsylvania Avenue south
Minneapolis, Minnesota 55426

Merrick and Company
Consulting Engineers
2700 West Evans
Denver, CO 80219

Murry - McCormick
Aerial Surveys Inc.
6220 24th Street
Sacramento, CA 95822

Photographic Interpretation Corporation
Box 868
Hanover, New Hampshire 03755

Quinn and Associates
460 Caredean Drive
Harsham, Pennsylvania 13044

Sanborn Map Company, Inc.
P.O. Box 61
629 Fifth Avenue
Pelham, NY 10803

The Sidwell Company
Sidwell Park
28 W 240 North Avenue
West Chicago, 111 60185

Surdex Corporation
25 Mercury Boulevard
Chesterfield, MO 63017

Teledyne Geotronics
725 East Third Street
Long Beach, CA 90812

United Aerial Mapping
5411 Jackwood Drive
San Antonio, TX 78238

Walker and Associates Inc.
310 Perfontaine Building
Seattle, Washington 98104

Western Aerial Contractors, Inc.
Mahlon Sweet Airport - Route 1, Box 740
Eugene, Oregon 97401

Foreign Government Agencies

National Air Photo Library
Survey and Mapping Building
615 Booth St.
Ottawa, Canada KIA OE 9

GROUND IMAGERY SOURCES

US Army Imagery Interpretation Group
Bldg. 213, Washington Navy Yard
Washington, DC 20374

Defense Intelligence Agency
ATTN: RPP-3
Washington, DC 20301

US Army AMC Service Support Activity
Audio-Visual Presentations division
Room 1C13, Pentagon
Washington, DC 20310

Glossary

ACRONYMS AND ABBREVIATIONS

AK	Arkansas
AL	Alabama
ALZ	air landing zone
APPS	analytical photogrammetric positioning system
AR	Army regulation
ARTYMET	artillery meteorology
ATTN	attention
AWS	air weather service
AZ	Arizona
C	Celsius
C A	California
CCM	cross-country movement
CI	cone index
cm	centimeter
CO	Colorado
Cos	cosine
Cot	cotangent
Csc	cosecant
DA	Department of the Army
DBH	diameter at breast height
DC	District of Columbia
DFAD	digital features analysis data
DMA	Defense Mapping Agency

DSS	direct support system
DTED	digital terrain elevation data
DTSS	digital topographic support system
DZ	drop zone
EAC	echelon above corps
EETI	essential elements of terrain information
etc.	et cetera
F	Fahrenheit
FALOP	Forward Area Limited Observation Program
FC	field circular
FM	field manual
FRG	Federal Republic of Germany
G2	Assistant Chief of Staff, G2 (Intelligence)
Ggf	ground gained forward
Ggs	ground gained sideways
H	altitude of the aircraft above mean sea level
h	average terrain height above mean sea level
HLZ	helicopter landing zone
HO	height of obstacle
ID	identification
IL	Illinois
IN	Indiana
IPB	intelligence preparation of the battlefield
km	kilometer
kph	kilometers per hour
LOC	lines of communication
LOS	line of site
m	meters
MD	Maryland
METT-T	mission, enemy, terrain, troops, and time available
MGI	military geographic information
MI	military intelligence
MI	Michigan
MLC	military load classification
mm	millimeters

MN	Minnesota
MO	Missouri
MOUT	military operations on urbanized terrain
mph	miles per hour
MRF	map representative fraction
MSR	main supply route
MT	Montana
MTR	minimum turning radius
MY	New York
NATO	North Atlantic Treaty Organization
NCO	noncommissioned officer
NE	Nebraska
NH	New Hampshire
NM	New Mexico
NO	number
NOE	nap of the earth
OCOKA	observation and fields of fire, cover and concealment, obstacles, key terrain, and avenues of approach
OD	override diameter
OH	Ohio
OK	Oklahoma
OR	Oregon
P	paved
PA	Pennsylvania
PDG	point designation grid
PI	photo interpretation
PRF	photo representative fraction
PSR	photo scale reciprocal
PTADB	planning terrain analysis data base
QPS	quantity processing system
RCI	rating cone index
RDZ	paratroop/resupply drop zone
RF	representative fraction
RI	remolding index
RSI	remote-sensed imagery

RTZ	radius of touch zone
S2	intelligence officer (US Army)
SD	stem diameter
SD	South Dakota
Sec	secant
SF	safety factor
SIF	slope-intercept frequency
Sin	sine
SLAR	side-looking airborne radar
S s	stem spacing
Swo	staff weather officer
Tan	tangent
TC	tree count
TGR	takeoff ground run
TM	technical manual
TN	Tennessee
TOE	table(s) of organization and equipment
TTADB	tactical terrain analysis data base
TX	Texas
u	unpaved
Uc	under construction
us	United States (of America)
USAF	United States Air Force
USAFETAC	United States Air Force Environmental Technical Applications Center
USCS	Unified Soil Classification System
USGS	United States Geological Survey
USSR	Union of Soviet Socialist Republics
UT	Utah
UTM	universal transverse mercator
VA	Virginia
VCI	vehicle cone index
VF	vehicle factor
VR	vegetation roughness
VRF	vegetation roughness factor

WA	Washington
WCET	windchill equivalent temperature
WETM	weather teams
WI	Wisconsin
ZOE	zone of entry

TERMS

abutment - the support at either end of a bridge.

air base - an airfield having, in addition to operational facilities, shelter for personnel and facilities for supply and repair of aircraft.

airfield - a group of facilities designed for takeoff, landing, servicing, fueling, and parking of fixed-wing and rotary-wing aircraft.

alluvium - general term for material deposited by streams, including silt, sand, gravel, clay, or boulders derived from decomposed bedrock but deposited elsewhere.

altitude - the height above an established reference base. Altitude is usually measured as height above mean sea level.

apron, cargo - a prepared area for loading and unloading personnel and cargo.

apron, maintenance - a prepared area for parking aircraft being serviced or repaired.

apron, parking - a prepared area used in place of hardstands for the parking of aircraft. It is also referred to as a conventional apron.

apron, warmup - a stabilized or surfaced area used for the assembly or warming up of aircraft, usually located at both ends of the runway adjacent to and with the long axis parallel to the connecting taxiway.

aqueduct - a large pipe or conduit made for transporting water from a distant source.

avenue of approach - route by which a force may reach an objective.

badlands - a geographical area nearly void of vegetation. An almost impassable region due to narrow avenues, sharp crests, and pinnacles.

bank - the continuous sloping margin of a stream or other water body; on a stream, designated left or right bank as it would appear to an observer facing downstream.

bar - an accumulation of alluvial material in a stream channel, commonly emergent at low water.

basalt - common name for a group of dark, fine-grained, heavy, very hard volcanic rock.

bed - the bottom on which a body of water rests.

bog - a swamp or tract of wet land commonly covered with peat.

brush - shrubs and stands of short, scrubby tree species that do not reach sufficient size for use as timber.

canal - a channel or waterway artificially constructed or maintained for conveying water or for connecting two or more bodies of water.

canopy - uppermost closed surface or roof of the forest.

channel - the trench in which a stream normally flows; that part of a body of water deep enough to be navigable.

channel cross section - a representation of a channel as it would appear if cut through crosswise and vertically at right angles to its long axis and depicting, specifically, the area of the channel through which flow has passed or is supposed to pass.

channel roughness - roughness of the channel, including extra roughness due to local expansion or contraction and obstacles, as well as roughness of the stream bed proper, such as friction offered to the flow by the surface of the bed of the channel in contact with the water; expressed by the roughness coefficient of the velocity formulas.

classification yard - a yard in which the traffic is classified in accordance with requirements and made up into trains.

clay - soil particles having diameters less than 0.0002 millimeters.

concealment - protection from observation only,

conduit - an artificial or natural channel which carries water for supply or industrial purposes.

conifer - cone bearing - trees of the "soft-wood" group such as spruce and pine. Most but not all conifers are evergreen and needle-leaved.

coniferous forest - a forest of evergreen coniferous or cone-bearing trees carrying needle-shaped leaves. Such forests have valuable softwood timber.

contamination - impairment of the quality of water to a degree which creates an actual hazard to public health by toxic chemicals, radioactive isotopes, or pathogenic organisms.

contour density - the spacing of contour lines on a map.

cover - protection from weapons fire.

cross-country movement - movement across terrain that is not specifically improved for vehicular traffic.

crown - the entire leafy part of a tree or shrub, especially as seen from above.

current velocity - the speed, expressed in units of time and distance, at which water flows in a stream, channel, or conduit.

data base - a collection of information in any form, assembled for a particular future use.

deciduous - vegetation losing all their leaves seasonally, either in the cold or dry season.

deciduous forest - a forest consisting of trees that lose their leaves at some season of the year. Such forests have valuable hardwood timber.

dendritic - a branching tree-like pattern of tributaries of a main stream.

departure yard - a yard in which trains are placed waiting departure.

diameter breast height - the diameter of a tree at 1.4m (approximately 4.5 feet) above ground level. It is abbreviated DBH.

drainage - the process of removing surface water or ground water by artificial or natural means.

engine yards or terminals - an area containing all the tracks, buildings, structures, and facilities necessary for the maintenance, care, and storage of locomotives and for providing them with all needed supplies such as fuel, water, sand and oil.

estuary - the portion of a stream valley influenced by the tide of the body of water into which it flows.

evergreen - vegetation that retains its green foliage throughout the year.

flight line - a line drawn on a map or chart to represent the flight path which an aircraft has flown when taking a series of consecutive aerial photos.

flow - a quantity of water carried by a stream or conduit, expressed in volume per unit of time.

freight terminal - the installation and facilities for handling freight business.

fiducial marks - index marks rigidly connected with the camera lens through the camera body, which form images on the negative. These marks, when intersected by a straight line drawn between opposite fiducial marks, define the principal point of the photographic print.

fuel storage area - an accessible area, having good cover, located a safe distance from troops, aircraft, and other facilities, and used for the storage and dispensing of aviation fuels.

gradient - the longitudinal slope, obtained by dividing the difference in bed or water-surface elevations.

grasslands - regions or areas where the dominant natural vegetation consists of grass.

gravel - loose, coarse, granular material larger than sand grains, resulting from breaking down of rock.

gravity yard - a yard in which the movement of cars to different sidings for sorting is accomplished by gravity alone.

hardstand - a stabilized or surfaced area provided to support standing aircraft. Hardstands are normally dispersed at intervals along each side of a taxiway.

hectare - 10,000 square meters, or 2.47 acres.

helicopter landing pad (helipad) - a prepared area on the ground designated and used only to accommodate takeoff and landing of helicopters.

heliport - a group of facilities designed for takeoff, landing, servicing, fueling, and parking of rotary-wing aircraft.

heliport landing area - a specifically prepared surface designed for rotary-wing aircraft takeoff and landing operations. It includes the paved surface (runway or landing pad) and the areas immediately adjacent thereto that have been cleared of all above-ground obstructions.

hydrology - a science dealing with the occurrence of water on the earth; its physical and chemical properties, transformations, combinations, and movements; especially with the course of water from the time of its precipitation on land until its discharge into the sea or return to the atmosphere.

index contour - contour line shown more prominently than the adjacent ones, usually every fifth one.

inland waterways - rivers, canals, lakes, and inland seas that are used as avenues of transport.

intermittent stream - a stream that flows only seasonally; one that has not cut its valley below the water table.

key terrain - any area whose seizure or control affords a marked advantage to either opposing force.

landform - the physical expression of the land surface.

lateral safety zone - an area (transitional surface) located between the runway clear area of runway edge when no clear area is provided and the clearance lines limiting the placement of building construction and other obstacles with respect to the runway centerline. The slope of the transitional surface is 7:1 outward and upward at right angles to the runway centerline.

levee - an embankment along a stream or other water body, built for the purpose of limiting floods.

line of sight - intervisibility between two points located on the earth's surface.

lines of communication - all routes--land, water, and air--that can be used by military forces in an area of operations.

local relief - the difference in elevation of the land surface.

lock - an enclosure in a canal or river with gates at each end, used in raising or lowering boats as they pass from level to level.

marsh - a tract of spongy, wet, or water-covered treeless ground usually covered by grasses, cattails, or similar vegetation.

observation - ability of force to exercise surveillance over a given area through the use of personnel or sensors.

obstacle - any object that stops, delays, or diverts movement.

outcrop - any exposure of bedrock.

overrun - a graded and compacted portion of the clear zone, located at the extension of each end of the runway to minimize risk of accident to aircraft due to overrun on takeoff or undershooting on landing. Its length is normally equal to that of the clear zone and its width is equal to that of the runway and shoulders.

parallax - the apparent displacement of the position of a feature with respect to a reference point or system caused by a shift in the point of observation.

passenger terminal - the installation and facilities for handling waiting passengers.

permeability - a rock's capacity for transmitting fluids.

photo base - the straight-line distance between the two principal points of two consecutive serial photographs.

planimeter - an instrument for measuring the area of any plane figure by passing a tracer around the boundary line.

pollution - impairment of the quality of water by biological, chemical, physical, and radioactive substances to a degree which may not create an actual hazard to public health but which does adversely and unreasonably affect such water for some beneficial uses; almost any substance becomes a pollutant if concentrated sufficiently.

pond - a small area of still water, usually artificial.

porosity - a measure of the proportion of a material consisting of pore space or voids.

profile - the bottom or water surface elevation of a stream plotted against distance.

relief - the irregularities of a land surface.

representative fraction - the ration between map or photo distance and ground distance expressed as a fraction in the same units.

reservoir - an area of water storage often artificially created by building a dam at a suitable retaining point across a watercourse.

revetment - usually a mound or wall of earth, masonry, timber, sandbags, or other suitable material erected as a protection for aircraft against small arms or artillery fire, bomb splinters, or blast.

road, access - a two-way road, normally improved, connecting the air base or airfield with the existing road system of the vicinity.

road, service - a road connecting the access road and the bomb and fuel storage areas with all hardstands and aprons for the purposes of refueling, rearming, and servicing aircraft.

running track - a track reserved for movement through a yard. Running tracks are provided for movement in either direction to enable yard engines to pass freely from one part of the yard to another.

runoff - that portion of the precipitation that is transmitted through natural surface channels; the residual of rainfall after the deduction of losses.

runway - a stabilized or surfaced rectangular area located along the centerline of the flightstrip on which aircraft normally land and take off.

sand - individual rock or mineral particles having diameters ranging from 0.5 to 2.0 millimeters.

sandstone - a sedimentary rock composed of sand-sized grains of minerals and rock fragments cemented together.

scale - the ratio between the distance on a map or photo and the corresponding distance on the ground.

sedimentation - the process by which mineral and organic matter are deposited to make sediments.

shoulder - a graded and compacted area on either side of the runway to minimize the risk of accident to aircraft running off or landing off the runway.

shrub - a low plant (not more than 5 meters high) with woody stems branching near the base.

siding - a short track connected to the main track by a switch and used for unloading, bypassing, and so forth.

silt - individual mineral particles of soil that range in size between clay and sand (0.002 m to 0.5 millimeters in diameter).

single track - a main track upon which trains are operated in both directions.

species - a kind of plant that can be distinguished from all others on the basis of inherited characteristics.

spring - a natural flow of water from the earth's surface occurring where the water table intersects the course.

sour track - a track of indefinite length diverging from a main line or track.

stand - an aggregation of trees, standing in a definite limited area.

stand density - density of stocking expressed in number of trees per hectare.

station - a place designated by name on the timetable at which a train may stop for traffic, enter or leave the main tracks, or from which fixed signals are operated.

stereoscope - a binocular instrument used for viewing in three-dimensional expressions.

storage yard - a yard in which cars are held awaiting disposition.

stream - a general term for a body of flowing water. The term is usually applied to water flowing in a natural surface channel; but it may also be applied to water flowing in an open or closed conduit and to a jet of water issuing from an opening.

swamp - a tract of wet or water-covered ground overgrown with trees and shrubs.

switch engine - an engine assigned to yard service and working within yard limits.

synthesis - the combining of elements of diverse material into a single or unified product.

takeoff ground run - the distance traveled by an aircraft along the runway before becoming airborne.

taxiway - a prepared strip for the passage of aircraft on the ground to and from the runway and parking areas. The width of the taxiway includes a stabilized, surfaced, or paved central strip.

texture - the frequency of change and arrangement of photographic tones.

touchdown area - that portion of the beginning of the runway normally used by aircraft for primary contact of wheels on landing.

tree - a woody, perennial plant with a single main stem more than 5 meters tall,

tributary - a surface or underground stream which contributes its water, either continuously or intermittently, to another and larger stream.

turbidity - the approximate amount of suspended matter in water, expressed in parts per million.

water body - an inland body of water which may or may not have a current or single direction of flow, such as a lake, reservoir, or pond.

water table - the upper surface of the zone of saturation.

watershed - the entire region that contributes water to a river or lake. Also called a drainage basin, river basin, or catchment area.

well - a deep hole or shaft sunk into the earth to tap an underground supply of water.

yard - a system of tracks provided for making up trains, storing cars, or for maintaining or repairing cars.

zone of entry - any area in which personnel, supplies, or equipment can be placed within reach of a military objective.

References

REQUIRED PUBLICATIONS

Required publications are sources which users must read to understand or to comply with FM 5-33.

Army Regulations (ARs)

- 115-10 Meteorological Support for the US Army
- 115-12 US Army Requirements for Weather Service Support

Field Manuals (FMs)

- 5-36 Route Reconnaissance and Classification
- 5-530 Materials Testing
- 90-4 Air Assault Operators
- 90-10 Military Operations on Urbanized Terrain (MOUT)
- 100-27 US Army/US Air Force Doctrine for Joint Airborne and Tactical Airlift Operations

DA Forms

- 1249 Bridge Reconnaissance Report
- 1250 Tunnel Reconnaissance Report
- 1252 Ferry Reconnaissance Report
- 2028 Recommended Changes to Publications and Blank Forms

RELATED PUBLICATIONS

Related publications are sources of additional information. They are not required to understand FM 5-33.

Army Regulations (ARs)

115-1 Point Weather Warning Dissemination

Defense Mapping Agency (DMA) Publications

150 World Port Index

Field Manuals (FMs)

21-26 Map Reading and Land Navigation

101-5 Staff Organization and Operations

Technical Manuals (TMs)

5-312 Military Fixed Bridges

5-330 Planning and Design of Roads, Air Bases, and Heliports in the Theater of Operations

5-6675-324-14 Operator's Organizational Direct Support and General Support Maintenance Manual for Topographic Support System Information Section

5-6675-325-14 Operator's Organizational Direct Support and General Support Maintenance Manual for Topographic Support System Synthesis Section

5-6675-326-14 Operator's Organizational Direct Support and General Support Maintenance Manual for Topographic Support System Direct Support Section

PROJECTED PUBLICATIONS

Projected publications are sources of additional information that are scheduled for printing but are not yet available. Upon print, they will be distributed automatically via pinpoint distribution. They may not be obtained from the US Army AG Publications Center until indexed in DA Pamphlet 25-30.

FM 5-312 Nonstandard Fixed Bridging

INDEX

A

aerial imagery (1-3), (3-4), (3-5), (3-25), (3-26), (9-12)

all-weather, hard-surface dual/divided highways (2-4)

air landing zones (7-5 through 7-7), (7-12)

airfield

aprons (2-30)

data table (5-5)

airfields (Intro-8), (1-4), (2-3), (2-28), (2-29), (4-7), (4-8), (4-14), (5-1), (5-5), (5-7), (7-5 through 7-7)

all-weather, loose-surface highways (2-5)

ALZs (*see* air landing zones)

amphibious landing beaches (7-5), (7-11)

analysis, gully (1-8), (1-9)

anchorage (2-20), (2-21), (2-23)

angle of repose (10-3)

annular pattern (1-13)

approaches (2-13), (2-16), (2-24), (2-27), (4-4), (4-6), (4-13)

APPS (Intro-3), (7-1)

arch culverts (2-14)

area measurement (9-10), (9-11)

arid climates (1-5), (1-10), (7-12)

ARTYMET (B-1)

Atterberg liquid limit test (1-6)

avenue of approach (6-15)

B

basins (1-12), (2-19)

battalion (Intro-5), (Intro-6)

battlefield terrain (Intro-1), (Intro-2), (Intro-5), (6-15), (B-1)

berth (2-21), (2-23), (2-25)

bitumen (2-4)

bogs (3-6), (7-12)

box culverts (2-14)

breaking test (1-8)

bridge superstructures (2-12)

bridges (2-2), (2-3), (2-5), (2-10 through 2-13), (2-15), (2-17), (4-3), (4-4), (4-8 through 4-10), (5-2), (5-3), (7-4)
 fixed (2-13)

 low-water (2-17)

 movable (2-13)

brushlands (3-7)

building type (4-20)

C

cableways (2-10), (2-17)

caissons (2-26), (2-27), (4-16)

canopy closure (3-6), (3-8 through 3-10), (5-5 through 5-7)

cantilever crane (2-22)

cart tracks (2-5)

CCM (*see* cross-country movement)

classification (1-4 through 1-6), (1-8), (1-15), (2-4), (2-7), (2-13), (2-14), (2-24), (3-5), (3-6), (3-7), (3-23), (4-1), (4-20), (4-23), (8-1), (B-1)
 field (1-5), (3-23)

 military load (2-13)

classification (marshalling) yards (2-7)

clay (1-4 through 1-6), (1-8), (1-9), (1-14), (2-5), (4-11)

climate (Intro-1), (Intro-2), (1-1), (1-9), (1-10), (3-4), (7-5), (7-8), (B-2)

climatology (B-1 through B-5)

communication facilities (2-2)
complementary angle (10-5)
complex factor overlay (6-8)
concealment (*See* cover and concealment)
concealment overlay (5-7)
concentric (2-1)
cone index (CI) (3-22)
contour conforming (2-1)
contour interval (3-1 through 3-3), (3-23), (3-26), (4-9), (6-7), (6-8), (7-3), (7-4)
conversions (10-14)
coordination (Intro-5)
corps topographic company (Intro-3), (Intro-6)
cranes (2-8), (2-20 through 2-22)
cross-country movement (1-12), (1-15), (3-1), (3-4), (5-1), (6-1), (6-14), (6-15)
crown micrometer wedge (3-11)
culverts (2-10 through 2-13), (2-14), (4-15)

D

data bases (Intro-2), (Intro-4), (Intro-7), (Intro-8)
deck surface (2-25)
dendritic drainage pattern (1-16)
density (1-3), (1-13), (1-14), (3-4 through 3-6), (3-8), (3-10), (3-12), (3-17) (4-19), (7-5)
depressions (1-1), (1-15), (3-26)
depth to bedrock (3-22)
derrick (2-23)
determination of area (10-1)
determination of volume (10-2)
differential parallax (9-7)
Digital Feature Analysis Data (DFAD) (2-1)
division terrain teams (Intro-3), (Intro-6)
DMA (Intro-1), (Intro-2), (Intro-7), (Intro-8), (3-17), (3-26)

DMA Pub 150 (7-11)

dolphins (2-21)

dot grid template (9-10)

dot-type scale (3-11)

double-leaf miter gates (4-15)

drainage (Intro-4), (Intro-7), (1-2), (1-4), (1-12 through 1-15), (3-1), (4-12), (4-19), (5-6), (7-5)
 surface Intro-7), (1-12), (1-15), (7-5), (7-11)
 subsurface drainage (1-12)
 internal (1-14)
 (see also patterns)

drop zones (DZ), (7-5 through 7-11)

dry strength test (1-8)

dry-soil factor (6-1), (6-2), (6-11)

DSS (Intro-6)

DTSS (Intro-4)

E

EAC (*see* echelons above corps)

echelons above corps (Intro-2), (Intro-5), (Intro-6), (Intro-8)

EETI (Intro-2), (3-6), (3-19)

embankments (1-1), (1-15), (2-3), (3-26), (7-5)

end points (2-9), (2-10), (4-14)

engineers (Intro-4), (1-5)

entry zones (7-5), (7-7), (7-8 through 7-12)

escarpments (1-15), (3-26)

F

factor overlays
 soil (1-4), (3-17)
 complex (6-12)
 obstacle (7-12)
 vegetation (3-4), (3-6), (3-17), (5-6), (5-7), (6-1), (6-4), (6-5), (6-8), (6-11), (6-12), (7-12)
 final (8-1)
 transportation overlay (7-5)

urban (2-1)
fair-weather, loose-surface highways (2-5)
FALOP (B-1)
ferries (2-3), (2-5), (2-10), (2-15), (2-16), (4-7), (4-13), (5-1), (5-2)
ferry crossing (4-13)
ferry terminal layout (4-13)
flap gates (2-27)
flat trajectory weapon (5-5), (5-6)
floating crane (2-22)
fords (2-3), (2-10), (2-16), (2-17), (4-6), (4-7), (4-12), (5-3)
freight cars (2-7), (2-9)
freight stations (2-7)
freight yards (2-7)
frost depth (B-4)

G

G2 (Intro-2), (Intro-6), (3-7), (6-15)
gages (2-6), (2-7), (4-8)
galleries (2-5), (2-10), (2-14), (2-15), (4-3), (5-1)
gantry crane (2-22), (2-23)
geometric functions (9-11), (10-1)
Ggf (*see* ground gained forward)
Ggs (*see* ground gained sideways)
gradation (1-5)
gradient (1-1), (1-9), (2-5), (3-26), (4-3), (4-9), (4-15), (7-8), (7-11)
grass (1-2), (1-5), (1-11), (4-10), (5-6), (B-4)
gravel (1-4), (1-5), (1-8), (1-9), (1-15), (2-4), (2-5), (2-16), (4-10), (4-12), (4-14), (10-3)
ground
 distance (3-12), (3-13), (4-15), (9-1 through 9-3)
 gained forward (9-3), (9-4)
 gained sideways (9-4)
 slope (1-9), (6-1), (6-2)
 water (1-5), (1-9 through 1-12)

gullies (1-9), (1-11), (1-13), (2-17), (3-16)

H

harbor (2-20 through 2-22), (2-24), (2-26), (2-27)

harbor craft (2-26)

harbor-dredging operations (2-26)

harbor works (2-21)

harbors (2-19), (2-20), (2-23), (2-24)

hectare scale (3-14)

hedgerows (1-15), (3-26)

height determination (9-4), (9-7)

helicopter landing zones (7-5), (7-8), (7-11), (7-12)

helipad (2-29)

heliports (2-28), (4-7), (4-8)

highways (2-3 through 2-6), (2-10)

hills (1-1), (1-10), (1-13), (2-6), (7-3)

HLZs (*see* helicopter landing zones)

horizontal distance (1-1), (1-2), (3-1 through 3-3), (4-3), (7-6)

hydrographic conditions (7-11)

hydrologic obstacles (1-15)

hydrology (Intro-4)

I

imagery (Intro-2), (Intro-4), (Intro-5), (1-3), (3-6), (3-8), (3-25), (3-26), (4-12), (7-2), (9-1), (9-9), (9-12), (10-1), (10-4)

integration (Intro-5)

intelligence (i through v), (Intro-8), (1-1), (1-2), (2-1), (2-3), (2-5), (2-10), (2-15), (2-27), (6-9), (B-1), (B-3)

intelligence preparation of the battlefield (Intro-2), (Intro-8)

interpretation (Intro-4), (Intro-5), (Intro-6), (1-3), (2-4), (2-5), (3-7), (7-2), (10-1), (10-14), (10-5)

intervisibility (7-1), (7-4)

IPB (*see* intelligence preparation of the battlefield)

J

jib crane (2-22), (2-23)

K

key terrain (Intro-3)

L

landforms (1-1), (1-16), (2-3), (3-14), (3-15), (7-12)

landing zones (7-5), (7-8)

landing site (7-9), (7-12)

landings (2-27 through 2-29)

leaf gates (2-27)

line of sight (3-4), (7-1)

linear measuring probe (9-12)

linear obstacles (3-25)

lines of communication (3-26), (5-1), (4-12), (5-1 through 5-6), (7-8) (7-10), (7-13)

liquid limit (1-5), (1-6)

load capacity (2-13)

LOC (*see* lines of communication)

local relief (1-1)

locks (2-21), (4-15)

locomotive crane (2-23)

locomotives (2-7), (2-9)

long-range planning (B-1)

LOS (*see* line of sight)

M

man-made features (Intro-1), (Intro-2), (Intro-4), (1-15), (3-26)

map representative fraction (9-1)

map scale reciprocal (9-1), (9-2)

marshes (1-16), (3-7)

mean stem diameter (3-12), (3-13)

MGI (*See* military geographic information)

MICROFIX (7-1)

micrometer (3-11), (3-12), (9-5), (9-7)

military/civil category (2-2)

military geographic information (Intro-3), (Intro-4), (Intro-6)

military topographic maps (3-4)

mission (Intro-3), (Intro-4), (2-3), (7-2), (7-4), (7-12), (9-4)

mixed forests (3-8)

MLC (*see* military load classification)

moats (1-15), (1-16)

moorings (2-21), (2-23)

mosaic method (4-13)

MOUT (2-1)

MRF (*See* map representative fraction)

N

natural gas (2-17), (2-18)

naval bases (2-19), (2-27)

NCO (Intro-6)

O

oblique photos (4-10), (4-15), (10-13)

observations (Intro-8), (B-1 through B-4)

obstacles (Intro-3), (Intro-7), (1-3), (1-12), (1-15), (1-16), (3-25), (3-26), (4-6), (4-13), (7-5), (7-8), (7-11 through 7-13)

OCOKA (Intro-3), (Intro-4)

on-route fords (5-1)

operational intelligence (Intro-1), (Intro-5)

orchards and/or plantations (3-8)

organic sediments (1-5)

overlays (*See* factor overlays)

overpasses (2-6), (5-2)

P

parallax method (9-5)

passenger cars (2-9)

passenger stations (2-7)

patterns (1-13), (2-1), (3-19), (4-12), (B-5)
street (2-1)
rectangular drainage (1-13)
parallel (1-13)
radial (1-13)
trellis (1-16)
dendritic drainage (1-13)

PDG (7-2), (7-4)

permeability (1-11), (1-14)

photo
coverage (9-3)
distance (3-12), (4-13), (4-19), (9-1), (9-2)
representative fraction (4-13), (9-1)

photographic
scale (3-10), (3-12), (3-14), (3-16)
texture (1-3)
tone (1-3), (3-8), (4-8)

photos (1-16), (3-26), (4-10), (4-12 through 4-15), (5-1 through 5-5), (7-2), (7-3),
(9-4 through 9-5), (9-7), (10-14)

photos per flight line (9-4)

physical characteristics (2-3), (2-5), (3-25), (4-6)

piers (2-16), (2-20), (2-22), (2-24 through 2-26), (4-13)

pipe culverts (2-14)

pipelines (2-17), (2-25)

plains (1-1), (1-10), (1-12), (1-13)

planimeter (Intro-3), (Intro-4), (9-12)

planned irregular (2-1)

planning (Intro-1), (Intro-5), (2-1), (2-3), (3-17), (5-1), (B-1), (B-2)

plasticity (1-4), (1-5), (1-7), (1-8)

plateaus (1-1), (1-10), (1-12)

point designation grid (7-2)

porosity (1-11), (1-14)

porous rock (1-14)
port categories (7-10)
ports (2-19 through 2-24), (2-26), (7-5), (7-10)
precipitation (1-14), (2-4), (B-4), (B-6)
PRF (*See* photo representative fraction)
principal point (9-6), (9-9)
profile (3-19), (7-1 through 7-3)
PTADB (Intro-1), (Intro-7), (4-1)
Pythagorean theorem (10-16)

Q

QPS (*see* quality processing system)
quality processing system (Intro-3), (Intro-4), (9-11), (9-12)
quays (2-20), (2-24), (2-26)

R

radial (1-13), (2-1), (9-9)
railheads (2-8)
railroad and road cuts and fills (1-15)
 gages (2-6), (2-7)
 system (2-9)
railroads (2-2), (2-3), (2-5), (2-6), (2-9), (2-17), (3-26), (4-8), (4-14), (4-19), (5-1), (5-4)
rating cone index (RCI) (3-22)
RDZ (7-5)
refinery terminals (2-18)
relief (Intro-4), (1-1), (3-10), (3-11), (3-16), (9-8), (9-9)
relief displacement method (9-9)
remoldable sand (1-5), (1-8)
remolding index (RI) (3-23)
residential areas (2-2)
right triangles (10-4), (10-5)
road widths (2-3), (2-5)
roads factor overlay data table (5-2)

roads (Intro-2), (1-4), (2-2), (2-3), (2-5), (2-6), (2-17), (3-26) (4-1), (4-2), (4-7), (4-14), (5-1 through 5-4), (6-1), (7-6)

rocks (1-10), (1-12), (1-13), (2-30), (4-12), (5-5), (7-5), (7-12)

rolling stock (2-7 through 2-8)

roof coverage (2-1), (4-19), (5-5), (5-6)

route (Intro-4), (1-15), (2-4), (2-9), (2-10), (2-13 through 2-16), (2-30), (4-1 through 4-3), (4-7 through 4-10), (4-15), (5-1 through 5-4), (6-9), (7-10)

RSI (7-2)

runway azimuths (4-14)

S

sand (1-4 through 1-6), (1-8), (1-9), (2-5), (3-23), (4-12), (4-14), (10-3), (B-6)

sandstone (1-14)

scale determination (9-1)

sediments (1-5), (1-14), (2-26)

segmental gates (4-16)

semiarid climates (1-10), (1-11)

service yards (2-7)

shadow method (9-8)

shadows (2-9), (3-6), (3-7), (3-9), (3-10), (7-4)

shaking test (1-8)

shale (1-14)

shear-leg crane (2-23)

shipyards (2-22), (2-27)

shrubs (1-2), (4-10)

sieve analysis (1-5), (1-6)

SIF (6-7), (6-8)

silt (1-4 through 1-6), (1-8), (1-9)

single-leaf miter gates (4-15)

single photo method (4-13)

sinkholes (1-15), (3-26)

slip (2-16), (2-21)

slope (Intro-7), (1-1), (1-2), (1-9), (1-13), (1-15), (2-16), (3-1 through 3-4), (4-3), (4-9), (4-13), (6-1 through 6-8), (7-10), (7-11), (B-6)

slope calculator (3-2), (3-3)

slope intercept frequency (6-7)

snowsheds (2-5), (2-14), (2-15), (4-3), (5-1 through 5-3)

soil,

- analyses** (Intro-4), (1-6)
- data table** (3-25)
- nonplastic** (1-9)
- organic** (1-5)
- profile** (3-19)

special equipment (2-9), (2-22), (2-26)

species distribution maps (3-5)

speed/slope factor (6-4)

staff weather officer (Intro-8), (B-1 through B-3)

state of ground (3-19)

stem spacing (3-6), (3-13), (3-14), (3-16), (5-5), (5-7), (6-9), (6-10)

stereo coverage (3-4), (4-15), (9-4)

stereo imagery (3-4), (3-25)

stereometer (9-4), (9-5), (9-7)

stereoscope (7-4), (9-4), (9-5), (9-7)

stereoscopic pair (9-4)

stoniness (3-22)

storage category (2-3)

storage tanks (2-3), (2-7), (2-19)

surface

- configuration** (Intro-7), (1-1), (3-1), (3-3), (3-4), (4-9), (6-1), (6-4), (6-6), (6-7), (6-12), (7-11), (7-12)
- irregularities** (7-12)
- materials** (Intro-4), (Intro-7), (1-13), (3-17), (3-23), (3-25), (4-10), (6-1), (6-11), (6-12), (6-13), (6-14), (7-7), (7-11)
- materials analysis** (3-17)
- roughness** (1-1), (3-23), (3-25) (6-8), (7-6), (7-12)
- temperatures** (B-3)

swamps (2-3), (3-7), (3-8)

SWO (*see* staff weather officer)

synthesis procedures (5-1), (6-1), (6-9), (7-1), (7-11), (8-1)

T

tactical operations (Intro-8)

taxiways (2-29), (2-30), (7-7)

technical control section (Intro-6)

temperature (2-4), (3-19), (7-5), (7-7), (7-8), (7-12), (B-3 through B-5)

terminals (2-7), (2-17), (2-18), (4-7), (4-13)

texture (1-3), (1-5), (1-13), (1-14), (3-8), (4-12)

thermal and SLAR imagery (10-14)

TOE (Intro-6)

trafficability (Intro-3), (Intro-4), (1-2 through 1-5), (2-15), (3-17), (B-4 through B-6)

tramways (2-10), (2-17)

transportation (*See also* factor overlays)
category (2-2)

facilities (2-3)

tree crown diameter (3-11), (3-16)

trees,

deciduous (1-11), (3-8), (3-13)

coniferous (1-11), (3-7), (3-12)

broadleaf (1-2)

trigonometric functions (10-4), (10-5)

TTADB (Intro-1), (Intro-2), (Intro-7), (3-1 through 3-4), (3-6), (3-25), (3-26), (4-1)

tunnels (2-3), (2-5), (2-10), (2-14), (2-15), (4-3), (4-8), (5-1 through 5-3)

U

Unified Soil Classification System (1-5), (3-17), (3-22), 3-23, 3-25), (B-6)

Universal transverse mercator (2-13)

urban areas (2-1), (4-17), (4-18)

USAF (Intro-8), (7-6), (B-1), (B-2)

USCS (*see* Unified Soil Classification System)

USGS (3-26)

USSR (4-1)

UTM (2-13), (3-1), (3-6), (3-23), (3-26), (4-3), (7-2)

V

vegetation (*See also* factor overlays)
maps, small-scale (3-5)
roughness factor (VRF) (3-12), (6-9 through 6-11)
roughness table (6-8), (6-9)
table (3-13)

vehicle cone index (6-6)

vertical photography (4-10), (9-1)

vertical-lift gates (4-15)

vineyards (1-3), (1-16), (2-3), (7-11)

W

water

quantity (1-10)
resources (1-9), (1-12), (4-19)

waterways (2-3), (2-21), (4-15)

weather

forecasts (B-2)
observations (B-1), (B-2)

wells (1-10 through 1-13), (4-16)

wetlands (1-12), (3-7)

wharf length (7-10)

wharves (2-20 through 2-22), (2-24 through 2-26), (4-7), (4-15), (7-10)

wind direction (B-5), (B-6)

Windchill Equivalent temperature (WCET) (B-4)

Z

ZOE (*see* zone of entry)

zone of entry (6-9), (7-1), (7-4), (7-5), (7-11)

FM 5-33
11 JULY 1990

By Order of the Secretary of the Army:

CARL E. VUONO
General, United States Army
Chief of Staff

Official:

WILLIAM J. MEEHAN II
Brigadier General, United States Army
The Adjutant General

DISTRIBUTION:

Active Army, USAR, and ARNG: To be distributed in accordance with DA Form 12-11-E, requirements for FM 5-33, Terrain Analysis (Qty rqr block no. 4329); FM 30-10, Military Geographic Intelligence (Terrain) (Qty rqr block no. 0181); and FM 21-33, Terrain Analysis (Qty rqr block no. 0465).