



SS



Paladin

Combat Instruction Manual

Compiled by Cpl. Vernon Itas

- I. Introduction – 6
- II. Ideology and mindset – 9
- III. Guerrilla Tactics – 26
 - 1. The art of guerrilla warfare - 26
 - 2. Sniping and Marksmanship - 27
 - 3. Combat skills - 27
 - 4. Basic Security - 28
 - 5. Mission Planning and Execution – 33
 - 6. Interrogation - 38
 - 7. Counter-Intelligence – 38
 - 8. Psychological Operations/Warfare - 52
 - 9. Armed Propaganda – 56
 - 10. Development and Control of 'Front' Organizations - 57
 - 11. Initial recruitment – 57
 - 12. Organization of Cells for Security – 60
 - 13. Persuasion in Chats or Speeches – 63
 - 14. Oratory Basics – 67
 - 15. Creating a new identity - 71
- IV. Equipment and Weapons - 75
 - 1. Equipment if available – 75
 - 2. Gear and Tools – 77
 - 3. Unarmed Combat - 82
 - 4. Assassination – 85
 - 5. Car and Truck Bombs – 103
 - 6. Caching – 111
- V. OPSEC – 144
- VI. Guerrilla Intelligence – 163

- VII. Secret Meetings Guide – 180
- VIII. USB Dead drops – 183
- IX. Tactics against Law Enforcement Officers – 186
- X. Modern Weapons Outline – 189
- XI. Home-made Explosives – 205
 - 1. Molotov Cocktails – 216
 - 2. Swiss army knife blueprint – 219
- XII. Enemy Tactics and Guerrilla War – 223
 - 1. Guerrilla Mini-Manual – 223
 - 2. Jihadist Training Manual – 257
- XIII. War Tactics and Background Knowledge – 283
- XIV. Nerve Gas – 287
- XV. Firearms Manufacturing – 324
 - 1. Building a pistol from scratch - 362
 - 2. Building a 9mm SMG from scratch - 379
 - 3. Building a 12 Gauge Shotgun from scratch - 403
 - 4. Ammunition – 432
 - 1. Manufacturing Ammunition – 445
 - 2. Primers – 454
 - 3. Cartridge Assembly – 465
 - 4. Casting your own Bullets – 480
 - 5. Cartridge Cases – 492
- XVI. Explosives – 531
 - 1. Blasting Caps – 571
 - 2. Fuses and Ignition – 591
 - 3. Manufacturing Grenades – 614
 - 4. Manufacturing larger bombs and advanced bomb making – 631

1. Atomic Bombs – 632
- XVII. The Art of War by Sun Tzu - 635
- XVIII. Booby Traps - 657
- XIX. Body Armour - 659
- XX. The Enemy – targets and background - 661
- XXI. Bibliography - 665

SS Paladin

Hints for Guerrillas

I. INTRODUCTION

1. The Path of the Warrior

„Those who want to live, let them fight, and those who do not want to fight in this world of eternal struggle do not deserve to live.“

- Adolf Hitler

Was it the nagging of the jews in the media? Perhaps it was a relative who first told you to question the New World Order, or maybe you have read A Squire's Trial or Next Leap? Something has seemed off to you about the world. Our governments spew Cultural Marxist nonsense and our children are indoctrinated to worship Jewdom and spit upon tradition. ENOUGH! Your ancestors fought tooth and nail to provide the basis for a healthy, racially sound and nationally proud sphere of existence for you and your kin. Your descendants will ask themselves: what did he or she do when the Zionist Occupational Government was stripping rights away from us in their crypto-Marxist jewish attack on the advancement of the different races? Did you put a halt to the pollution of our gene pool with broken and dysgenic traits? Did you uphold the heritage and purity of your bloodline? How about usury and the exploitation of the common man? Your journey through life has been hazardous. In an age where the enemy has gained complete control over the media and public discourse, you have been forced into a corner. We are not backing down any further! We must immediately take the fight to the two-pronged crony capitalist and judeo-bolshevik World Order and topple them so our people can breathe again. For nature to be rebalanced and the races to have sufficient territory. For Folk and Nation we march ever forwards. I am glad you have found the courage to join our epic struggle against the destruction of our glorious past and the creation of a dystopian 1984 future. Like your ancestors, you will raise your sword and bellow with pure power of your blood for justice and natural order. The fight has begun and this book will light the path to effective National Socialist resistance.

2. The System cannot Remain

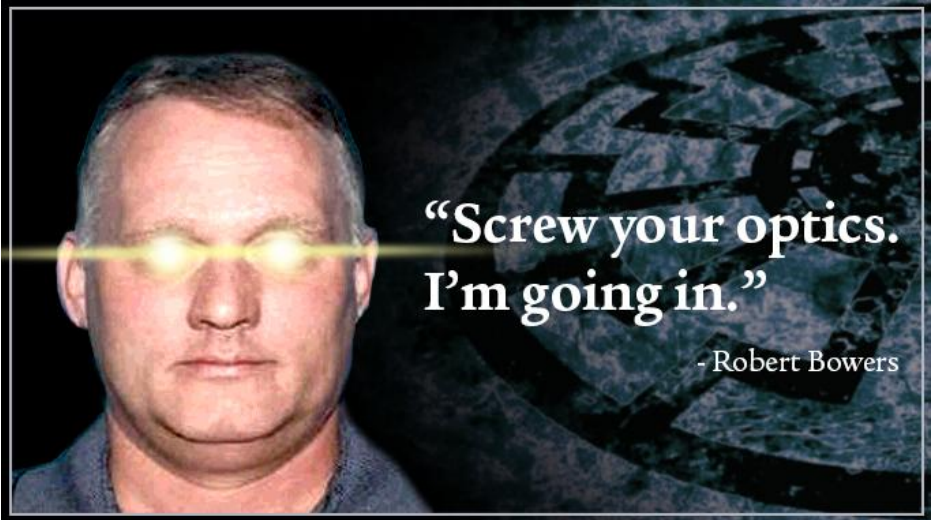

Only those who fully appreciate the impending danger of the Kalergi plan and the echoes of the Morgenthau plan, only those who see race mixing and degeneracy as an assault on our existence, only those who wish to avoid becoming a slave race are ready to join us. If you do not know why we must rise up against the Zionist Occupational Government and their goons across the world then it is time for you to reflect on the state of society.



Crime by violent subhuman IQ races is rising, debt-based economics and usury are crippling our economies, advancements in science are being squandered by unethical investment and predatory practices. Meanwhile those who can think and see beyond the curtain of consumerism, and imaginary marxist fantasies of equality, can only recognize a bleak state of affairs. Idealism, especially positive National Socialist construction and development in the most vital areas for human life, is ignored. Nobody is allowed to dream of a better future and capital is regularly spent on luxuries and decadence, not space colonization or the improvement of our health and natural ecosystems. The System is corrupt and heavily biased in favour of elites. Meritocracy on the other hand is a cornerstone of National Socialism. Fighting with us will imbue you not only with the growing certainty of universal truth, which meaningful action and intelligent decision making provides, but it will pay dividends in both material and psychological ways. Your struggle is a journey of self-improvement which is passed on to your community and then your nation.

Congratulations on surviving long enough to read these words. Our lives are too short to squander on inaction and weakness. True strength is what is needed to seize the day and destroy the post WW2 New World Order. We shall fulfil our destiny! The future belongs to us! Our race shall prosper! HAIL VICTORY!



II. Ideology and Mindset

1. What is National Socialism?



On the following pages a definitive introduction into classical National Socialist ideology is presented. It is essential that every single person understand and form their own beliefs and being, in order to be able to combine and rationally, yet critically, analyse as many different perspectives as possible. This, after all, is the purpose behind Idealism: the development of the human thought process and striving for perfect truth, its natural consequences and idealised systems.

Life is an eternal struggle between races for resources. We may be more than animals, but we are still bound by nature. Nature itself is no constraint for the human spirit. With knowledge of genetics and space colonization, we can finally be boundless and bring about an Aryan future of superhumans living in peace and harmony. Our genetic seed will spread among the stars and the glory of our race and nation shall shine bright for eons to come. Let us introduce some quotes from National Socialist figures describing the vision for a better future.

National-Socialism **by Alfred Rosenberg**

Upon a mountain, a knight with his servants constructed a proud fortress. All around this fortress gathered settlers seeking protection; houses were built, ramparts and walls erected, trenches dug. A community existed between knights and citizens: individuality and polity.

From the jumble of little houses the cathedral stretches upward toward Heaven. A great artist has designed it. Thousands have hewn the stones, hundreds of thousands have sacrificed things of value for it, and then in this house they performed this prayer: *personality and folk-soul*.

The sense or recognition of the economic and spiritual community of the whole of a people, [combined with] the acknowledgment of the role of the individual within the community, is today called National-Socialism.

There have been class-struggles as far back in history as we can trace. Many a people has already perished from them. There have been class-struggles even in the German past, and neither will they disappear in the future. The existence of struggle everywhere is no misfortune. But in the consideration of one of life's phenomena our spiritual attitude matters. If we recognize a folk as a kind of body, we will try, not to bolster artificially the natural struggle of a particular part of it, but to give forms to it that more highly cultivate and toughen each of the parts. If I aim only at the immediate goals of one of the struggling parts, sooner rather than later a sickening of the whole must occur, which weakens the body, indeed can bring about its death.

The age of the machine brought conditions of life that created the soil for a doctrine that with consistent implementation signifies the ruin of entire peoples: Marxism. No peoples, no states, only classes: a worldview that stands far below that of a Zulu, but for the victim of the machine, the industrial laborer, nonetheless signified an idea, even if muddled. The traditionless proletarian, torn from his soil, alienated from nature, entered into world-history. The subjection to a brutal power, which he understandably saw embodied in the entrepreneur – indeed he could not observe the banker standing behind this man – prevented instinct from perceiving that this man was a folk-comrade. It is not the laborer's fault if he succumbed to the seductive temptations of subversive Jewry! It is the fault of the German intelligentsia!

The [Idealist scholars] appear to have died out. Intellectual scholars alienated from nature, with blue pencils in their hands, studied the fat books of Marx and his comrades, drew analogies from their foggy verbiage to Kant, Goethe, and Indian philosophy, drew off the stale Jewish spirit into bottles, and made Marxism socially acceptable. Other professors, and not infrequently Lutheran ministers, were [freemasons] and spoke in secret lodges about "humanity," and about "liberty, equality, and fraternity." Large parts of the German people that must have recognized what was developing nonetheless let themselves be embittered by the gigantic Marxist propaganda and strengthened their class-identity. Thus was the German folk split asunder. The year 1914 showed however, that in all Germans

a spark was still alive that must have slumbered longingly in each one, so as to be able to blaze up into such a holy flame. But the decades had not been without effect. The misleaders of the people, having fallen silent for a short time, soon started in anew, and again the spirit was turned in a direction that finally precipitated the collapse of 9 November 1918. Faith to fight for a good cause was taken from the German and in him was cultivated a faith in slogans and ideas that were nothing but weapons of the trickery of our enemies. Never should the German people forget the names of the men that talked to them, amid the struggle over their destiny, about "international solidarity of the proletariat," "League of Nations," "conscience of the world," etc!

The misfortune came, and bitter disappointment therewith.

Nothing is more unjustified at present than the satisfaction of the German-Nationals that the workers had perceived the stupidity of internationalism and were ultimately halfway "sensible." These gentlemen should rather beat themselves on the breast and ask themselves what they did to strengthen the national feeling for the German worker! Did they go to him, did they give him spiritual nourishment, enlightenment, or did they hand him over to outright troublemakers and Jewish deceivers? Have they regarded the worker as a folk-comrade of equal value, or have they not valued him all too often as a human being of the second or third rank? Have they at least within their class itself advocated the worthiness of their folk, or have they not married Jewish bankers' daughters and contaminated the German people?

The recognition of their guilt in regard to the German folk has dawned upon many individuals among the conservatives, but certainly still not in the "nationalist parties." They designate themselves even today as "bourgeois" in opposition to the "socialistic," and the attempts of the German-Nationals to win the workers through a few old master bakers is a hopeless undertaking. As long as German conservatism does not openly and honestly swear a confession of guilt and vigorously take up the struggle against the Jewish and judaized parasitism outside and inside its ranks, and the struggle for German essence and interest in an all-encompassing sense, so long will it attract no manual laborer into its ranks. Like the Social-Democrats, the Conservatives are burdened with a heavy chain of class-tradition. They have forfeited the entitlement to be leaders; they must first win that for themselves.

Therefore a new movement is needed, which treats the whole German folk as an indissoluble unity, which accepts no class-antagonisms within the folk, for which the starting-point and final goal is what pertains to the folk, and which strives for a natural economic order instead of the current parasitic foreign bloodsucking. The unification of all genuinely productive persons of German blood and spirit, whether laborer, student, officer, civil servant, artist, or scholar, the gathering of all strugglers acting without regret for one Great Germany out of all strata of the German people: today that is called National-Socialism.

It will become the proud fortress, around which other Germans can build their houses. That is the way of the future!

On National-Socialism, Bolshevism, and Democracy

Joseph Goebbels

Men and women of the National-Socialist Party: Public life in Europe today is influenced by three striking political phenomena which I will group together under the popular heading 'National-Socialism, Bolshevism, and Democracy.' It is, however, clear to me that these names cannot define their full significance. The general public thinks of them as a triangle of irreconcilable contrasts. It would be understandable and logical if their reactions upon political personalities, actions, achievements, negotiations, and developments showed a corresponding degree of contrasts, but this is only the case to a limited extent. Often, and indeed mostly, we find, where decisive political problems are concerned, a united front of democracy and Bolshevism opposed to the nationalist, authoritarian States and their representatives. This is one of the most puzzling phenomena of modern politics. It can only be explained by the essential nature of the three political systems. I therefore think it necessary to analyse them in some detail from the theoretical point of view and in their effect on racial relations in Europe.

The political starting-point of democracy dates from the storming of the Bastille in 1789. The new principles of the State and social life which were then proclaimed, as previously in liberal philosophy, were Liberty, Equality, and Fraternity. ... Economic and cultural liberty was proclaimed. The individual, who in the authoritarian State was of secondary importance, emancipated himself and was released from the authoritarian tie to the State. The ideas and conceptions of this so-called 'Great Revolution' were expressed in the popular and psychologically prevalent slogan that all those who bear human form are equal. ... Everywhere the more or less complete severance of the tie which binds the individual to the community was elevated into a principle. The Revolution thus carried within it the seeds of the Marxist-Bolshevist conceptions which were later to arise. It was not until the twentieth century that this lack of connexion found its ultimate expression in the Bolshevist system. ...

The fact that the causes and effective potentialities of Bolshevism were already existent in a latent form in democracy explains why Bolshevism flourishes only on democratic soil, and is indeed generally the inevitable consequence of a radical and excessively democratic conception of the State. Bolshevism allegedly makes a classless society its aim. The equality of whatever bears a human form, which democracy applied only to political and social life, is set up as a ruling principle for economic life also. In this respect there are supposed to be no differences left. But this equality of all individuals in respect of economic goods can, in the Marxist-Bolshevist view, result only from a brutal and pitiless class struggle. ... It is only logical that in connexion with this, Bolshevism should proclaim the equality of nations and races. ... The opposition between the democratic and the Bolshevist mentality and conception of the State are in the last resort merely theoretical, and here we have the answer to the mysterious riddle which overshadows Europe and the explanation both of the

opposition in the lives of nations to-day and of the things which they have in common. It enables us to see at once why democracy and Bolshevism, which in the eyes of the world are irrevocably opposed to one another, meet again and again on common ground in their joint hatred of and attacks on authoritarian nationalist concepts of State and State systems. For the authoritarian nationalist conception of the State represents something essentially new. In it the French Revolution is superseded. ...

It is no proof to the contrary that democracy and Bolshevism will not make public admission of any common cause. ... They put up artificial oppositions of a purely theoretical character which on closer inspection are seen to be without substance. ... They do not touch the root on the matter. At heart democracy and Bolshevism are closely related and indeed almost identical. They represent merely different stages in the development of a common outlook. Bolshevism is in a sense the bad boy of democracy. Democracy gave it birth, brought it up, and alone keeps it alive. It may be ashamed of the connexion now and again, but at critical moments in European life the maternal instinct breaks through and the two again present a common front, united above all by the violence of their assault upon authoritarian-nationalist State concepts, which they have come to recognize as their bitterest, most dangerous foes. ...

We have modernized and ennobled the concept of democracy. With us it means definitely the rule of the people, in accordance with its origin. We have given the principle of Socialism a new meaning. ... Never have we left anyone in doubt that National-Socialism is not for export. ... We do not aim at world domination, but we do intend to defend our country, and it is our new conceptions which give us the inexhaustible and ever-renewed strength to do so. . . . We Germans were strong in the past, but nothing more than strong; and when our weapons were taken from us, we lay helpless. In that time of national suffering we learned that the strength of nations lies not only in weapons, but in ideas. A great idea and the faith which it inspires can remove mountains. Weapons cannot produce ideas, but, as Germany has shown, ideas can produce weapons. ... The Fuehrer himself gave us this great and vivid idea of liberty which fills and inspires us all to-day. And, most essential of all, he is producing the weapons with which to defend the ideas and their political and economic outcome. Now we no longer fear anyone or anything.

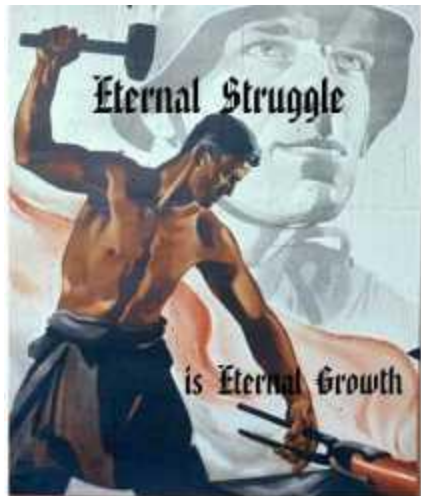

National Socialism on Race

Leon Degrelle

German racialism meant re-discovering the creative values of their own race, re-discovering their culture. It was a search for excellence, a noble ideal. National Socialist racialism was not against the other races, it was for its own race. It aimed at defending and improving its race, and wished that all other races did the same for themselves. That was demonstrated when the Waffen SS enlarged its ranks to include 60,000 Islamic SS. The Waffen SS respected their way of life, their customs, and their religious beliefs. Each Islamic SS battalion had an imam, each company had a mullah. It was our common wish that their qualities found their highest expression. This was our racialism. I was present when each of my Islamic comrades received a personal gift from Hitler during the new year. It was a pendant with a small Koran. Hitler was honoring them with this small symbolic gift. He was honoring them with what was the most important aspect of their lives and their history. National Socialist racialism was loyal to the German race and totally respected all other races.



National Socialism was and is a worldwide phenomenon.

National Socialism and the Laws of Nature

Martin Kerr

“...It is Life alone that all things must serve.”

– Adolf Hitler, *Mein Kampf*, Vol. I, Chap. 9, p. 215 (Manheim)

A unique and compelling feature of the National Socialist worldview of Adolf Hitler is that, of all the various political movements and ideologies of the modern era, it alone is based solely on the Natural Order. Only National Socialism is grounded in reality, and not in phantasms of the human mind.

National Socialists believe that the universe is governed by natural laws, and that for Man to be happy and successful, he must first acknowledge that these laws exist; secondly, he must discover what they are; and thirdly, he must live in accordance with them. This is another way of saying that the universe runs according to the principles of *Causality* – that is, of cause-and-effect relationships – and that it does not operate on the basis of supernatural forces, or on the mental constructions and wishful thinking of intellectuals and ideologues, or on the religious fantasies of theologians. Hitler made this clear from the beginning of his career in public life. Writing in his book *Mein Kampf* in 1924, he stated:

When Man attempts to rebel against the iron logic of Nature, he comes into struggle with the principles which he himself owes his existence as a man. And so his action against Nature must lead to his own doom... Here we encounter the objection [that] ‘Man’s role is to overcome Nature!’... But Man has never yet conquered Nature in anything, but at most has caught hold of and tried to lift one corner or another of her immense gigantic veil of eternal riddles and secrets, that in reality he invents nothing but only discovers everything, that he does not dominate Nature, but has only risen on the basis of his knowledge of various laws and secrets to be lord over those other living creatures who lack this knowledge... (Vol. I, Chap. 11, Manheim trans., p. 287)

And elsewhere:

Man must never fall into the madness of believing that he has risen to be lord and master over Nature – which is so easily induced by the conceit of half-education – but must understand the fundamental necessity of Nature’s rule, and realize how much of his existence is subject to these laws of combat and upward struggle. Then he will sense that in a universe where planets revolve around suns, and moons turn around planets, where force alone forever masters weakness, compelling it to be its obedient servant or else crushing it, there can be no special laws for Man. For him, too, the eternal principles of this ultimate wisdom hold sway. He can try to grasp them, but escape them never. (pp. 244-245)

The goal of National Socialism, then, is to consciously organize human society in accordance with the Natural Order. The postwar Danish National-Socialist Povl H. Riis-Knudsen thus defined National Socialism in a single sentence: “**National Socialism is the application of the Laws of Nature to human affairs.**”

The dominant thought-systems of today are uniformly based on the notion of human equality in one form or another: Multiracialism on racial equality;

Marxism on economic equality; democracy on political equality; Christianity on spiritual equality. But when Adolf Hitler observed the world of living Nature, he saw that it was not equality, but rather inequality, that was ever-present. To be more precise, he saw that Nature operated according to the principles of structure and hierarchy.

There is structure and hierarchy both among the races of mankind, and also within the races. The hierarchy among the races he denoted as the Principle of Race, and that within each race as the Principle of Personality. He discusses this in depth in Volume II, Chapter 4, of *Mein Kampf*.

In a speech given in 1928, Hitler gave his own one-sentence definition of the National Socialist worldview: **“All life is bound up in three theses: struggle is the father of all things, virtue lies in the blood, and leadership is primary and decisive.”** Here “blood” symbolizes the Principle of Race and “leadership” the Principle of Personality. “Struggle” is the mechanism by which position in the hierarchy is determined.

The belief that life should be lived in harmony with the Natural Order permeated the whole of Hitler’s Germany, from the top to the bottom. It manifested itself not just in the political structure of the National Socialist state, but in every facet of society, including child-rearing, nutrition, forestry, animal rights, medicine and healthcare. The protection of the environment was a top priority. Truly, National Socialism was the original “green” movement!

The SS had a popular motto: **“Know the laws of life and live in accordingly.”** Another SS saying pointed to the spiritual dimensions of the National-Socialist worldview: **“The Divine manifests itself in the order of Nature, not in supernatural miracles.”**

The scientific community enthusiastically supported the restructuring of society in harmony with the Natural Order. One example of this was botanist Ernst Lehmann, who characterized National-Socialism as “politically applied biology.” In 1934, only one year into the NS era, he wrote:

We recognize that separating humanity from Nature, from the whole of life, leads to mankind’s own destruction and the death of nations. Only through a reintegration of humanity into the whole of Nature can our folk be made stronger. That is the fundamental point of the biological tasks of our age. Mankind alone is no longer the focus of thought, but rather life as a whole... This striving with connectedness, with the totality of life, with Nature itself, a Nature into which we are born, this is the deepest meaning and the true essence of National-Socialist thought. (Biological Will: Way and Goal of Biological Work in the New Reich, pp. 10-11)

It is easy for the unsuspecting or the misinformed to fall victim to the vicious, lying, Hitler-bashing, anti-NS propaganda that is everywhere today. Attempts to discuss the profound and life-giving character of Adolf Hitler’s National Socialism often get sidetracked and bogged down in ridiculous and ill-informed debates concerning the conduct of German military operations during the Second World War – as though that subject were more important than our

survival as a race!

But one person saw clearly through the miasma of anti-Hitlerism even when it was at its height. The National Socialist philosopher Savitri Devi recognized the magnitude of Adolf Hitler's achievements, and of the unique value of his teachings – not just to the Aryan race, but to all mankind. In her magnum opus *The Lightning and the Sun* (1958) she wrote:

In its essence, the National Socialist idea exceeds not only Germany and our time, but the Aryan race and mankind itself and any epoch; it ultimately expresses that mysterious and unfailling wisdom according to which Nature lives and creates: the impersonal wisdom of the primeval forests and of the ocean depths and of the spheres in the dark fields of space; and it is to Adolf Hitler's glory not merely to have gone back to that divine wisdom ... but to have made it the basis of a practical regeneration policy of worldwide scope ... (The Lightning and the Sun, pp. 219-220, standard edition)

We live in a civilization and in a society that is about as divorced from the Natural Order as possible. That is why our race is sick. That is why our race is dying. Only by once again living in harmony with the Laws of Nature can we regain our racial health. There is only one movement which offers this salvation, and hence there is only one path to racial survival, that of Adolf Hitler and National Socialism.

National Socialist Economy

Axl Hess

Adolf Hitler's economic system – based partly off the genius of Gottfried Feder – was unlike anything the world had ever seen, and it worked better than anyone predicted at the time. National Socialist economics were of pivotal importance to Hitler's government, but those policies are sadly very poorly understood today. Breaking the bondage of interest slavery was strongly emphasized, though most Americans have never considered the idea of life without interest on a house or car payment. Once this concept is understood even slightly, it should become no wonder why the jewish international banking "community" at the time wanted so badly to destroy Germany, and why war was brought to the Fatherland. To spell it out clearly: If Germany's brilliant economic ideas had spread to other nations, this would soon lead to the end of outrageous profits and power for the banksters.

Germany's currency and trade systems begin to give one an understanding of the causes of World War II. This was stated by Hasting W. S. Russell, who wrote at the beginning of the War: "A war of financiers and fools, though most people, on the allied side at any rate, do not yet see very clearly how financiers come into it. . .

. Financiers also desired war as a means of overthrowing their rivals and consolidating still further their immense power. . . . Hitler not only engaged in barter trade which meant no discount profits for bankers arranging bills of Exchange, but he even went so far as to declare that a country's real wealth consisted in its ability to produce goods; nor, when men and material were available, would he ever allow lack of money to be an obstacle in the way of any project which he considered to be in his country's interests. This was rank heresy in the eyes of the financiers of Britain and America, a heresy which, if allowed to spread, would blow the gaff on the whole financial racket." Allied propaganda and nonsense has destroyed any serious study on National Socialist Germany, and therefore the general public (especially here in America) has a dismal or nonexistent knowledge of the socioeconomic policies implemented by Adolf Hitler to bring Germany out of depression in the 1930's. Gottfried Feder (an early mentor of Hitler) had been advocating banking reform as early as 1917, and was ardently against interest slavery and usury. He wrote a short book entitled, "Manifesto for the Breaking of the Bondage of Interest" that stated what many Americans are finally finding out today: The source of the bankers power and wealth comes not from work, but from "the effortless and infinite multiplication of wealth which is created by interest." Hence, why National Socialist Germany did away with the Jewish invention of interest slavery. Instead, the State offered loans for a set price. For example, marriage loans up to 1000 marks were implemented and were repayable in easy, interest free installments. A quarter of the loan was forgiven at the birth of each child. Via this method, people were never stuck paying off an interest charge each month like they are today with the credit card scam, but instead their payment actually went towards paying off their initial debt! An amazing concept!

Feder said, "Money is not and must not be anything but an exchange for labor; that to be sure any highly developed country does need money as a medium of exchange, but that this exhausts the function of money, and can in no case give to money, through interest, a supernatural power to reproduce itself at the costs of productive labor."

Before Adolf Hitler was elected, the NSDAP fought "against usury and the forcing up of prices. Against all those who create no values, who make high profits without any mental or physical work."

Adolf Hitler describes the National Socialist monetary system in a succinct paragraph: "If ever need makes humans see clearly, it has made the German people do so. Under the compulsion of this need we have learned in the first place to take full account of the most essential capital of a nation, namely, its capacity to work. All thoughts of a gold reserves and foreign exchange fade before the industry and efficiency of well-planned national productive resources. We can smile today at an age when economists were seriously of the opinion that the value of currency was determined by the reserves of gold and foreign exchange lying in the vaults of the national banks and, above all, was guaranteed by them. Instead of that we have learned to realize that the value of a currency lies in a nation's power of production, that an increasing volume of

production sustains a currency, and could possibly raise its value, whereas a decreasing production must, sooner or later, lead to a compulsory devaluation.” He added, “We were not foolish enough to try to make a currency [backed by] gold of which we had none, but for every mark that was issued we required the equivalent of a mark’s worth of work done or goods produced.” The National Socialist economy is one based off work and production. We owe Hitler for many of the “labor” comforts we enjoy today such as the 40 hour work-week, overtime, paid vacations, and holiday pay.

“Only one thing isn’t mentioned, you never hear a word about it, never a syllable, and there is nothing in the world which is such a curse on humanity. I mean, LOAN CAPITAL! Loan capital brings in money without work, brings it in through interest. I repeat: without lifting a finger the capitalist increases his wealth by lending his money. It grows by itself. No matter how lazy one is, if one has money enough and lends it out at interest, one can live high and one’s children don’t need to work either, or one’s grandchildren, or one’s great-great grandchildren, and so on to eternity! How unjust this is, how shameless – doesn’t everyone feel it? To infinity it grows, this loan capital” – Feder

“But who provides them [the jewish House of Rothschild] and their like with such an enormous amount of money? Interest has to come from somewhere after all, somewhere these billions and more billions have to be produced by hard labor! Who does this? You do it, nobody but you! That’s right, it is your money, hard earned through care and sorrow, which is as if magnetically drawn into the coffers of these insatiable people” – Feder

The twenty-five point “Program of the NSDAP,” again reflected the doctrines of the above-quoted Feder. Among these points are: 10. It must be the duty of every citizen to work either mentally or physically. The activities of the individual may not conflict with the interests of the general public but must be carried on within the framework of the whole and for the good of all.

Within two years of Adolf Hitler being elected, the unemployment problem had been solved and the country was back on its feet. It had a solid, stable currency, no debt, and no inflation, at a time when millions of people in the United States and other Western countries were still out of work and living on welfare. Germany even managed to restore foreign trade by using a barter system: equipment and commodities were exchanged directly with other countries, circumventing the international banks. This system of direct exchange occurred without debt and without trade deficits. Economist Henry C K Liu writes of Germany’s remarkable transformation:

The Nazis came to power in Germany in 1933, at a time when its economy was in total collapse, with ruinous war-reparation obligations and zero prospects for foreign investment or credit. Yet through an independent monetary policy of sovereign credit and a full-employment public-works program, the Third Reich was able to turn a bankrupt Germany, stripped of overseas colonies it could exploit, into the strongest economy in Europe within four years, even before armament spending began.

In Billions for

the Bankers, Debts for the People (1984), Sheldon Emry wrote: Germany issued debt-free and interest-free money from 1935 and on, accounting for its startling rise from the depression to a world power in 5 years. Germany financed its entire government and war operation from 1935 to 1945 without gold and without debt, and it took the whole Capitalist and Communist world to destroy the German power over Europe and bring Europe back under the heel of the Bankers. Such history of money does not even appear in the textbooks of public (government) schools today.



National Socialist economics: Pure Brilliance

Top Ten Essential /pol/ reading list

1. Mein Kampf



6. Culture of Critique



2. The Protocols



7. Plato The Republic

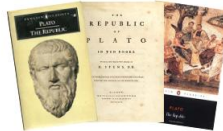

3. The International Jew

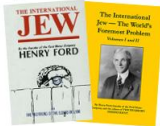

8. The Works of George Lincoln Rockwell



4. Hitler's Revolution

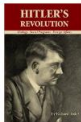

9. The Works of Julius Evola

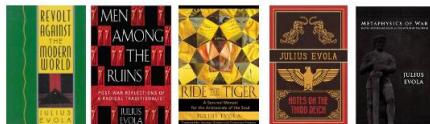

5. The Works of Gottfried Feder



10. Imperium

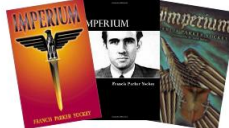



THE LITERATE NATSOC

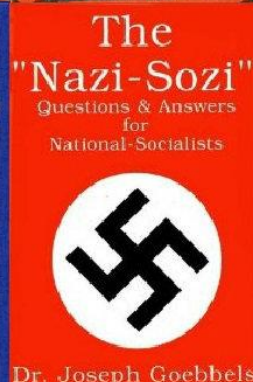
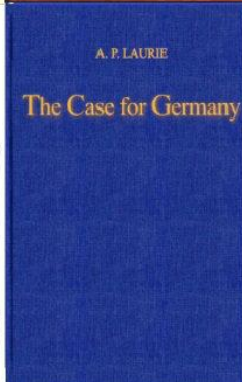
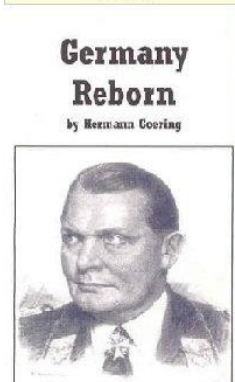
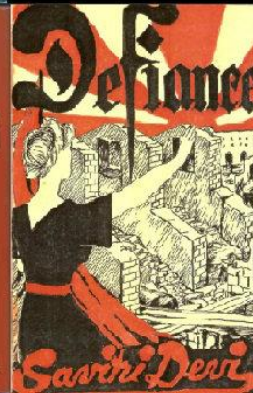
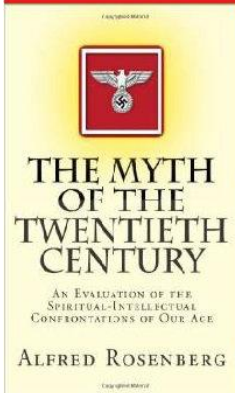
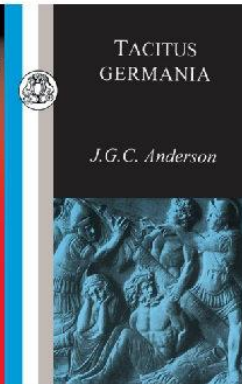
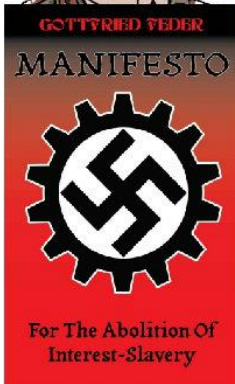



National Socialism

What is National Socialism?

National Socialism is the product of over a century of political and social thought cultivated in Germanic nations, popularized and first put into action by its foremost proponent, German Führer (Leader) and Chancellor Adolf Hitler.

It represents the most sound means of assuring the survival and advancement of our race. National Socialism was at first a political outlook adopted in several European nations, but evolved quickly into a pan-European vision.

Adolf Hitler summarized the worldview in *Mein Kampf*:

"For me and all true National Socialists there is but one doctrine: people and fatherland. What we must fight for is to safeguard the existence and reproduction of our race and our people, the sustenance of our children and the purity of our blood, the freedom and independence of the fatherland.

Every thought and every idea, every doctrine and all knowledge, must serve this purpose. And everything must be examined from this point of view and used or rejected according to its utility. Then no theory will stiffen into a dead doctrine, since it is life alone that all things must serve."

The practical goal of National Socialists today is to convert more people to our cause, in order to be able to create states guided by National Socialist principles.

2. Mindset of the Nat Soc Guerrilla

The Nat Soc guerrilla is a person who fights the zionist capitalist-marxist dictatorship with weapons, using unconventional methods. A revolutionary and an ardent patriot, he is a fighter for his country's liberation, a friend of the people and of freedom. The area in which the urban guerrilla operates is in the large cities.

The Nat Soc guerrilla, however, differs radically from a criminal. The criminal benefits personally from his actions, and attacks indiscriminately without distinguishing between the exploiters and the exploited, which is why there are so many ordinary people among his victims. The urban guerrilla follows a political goal, and only attacks the government, the big businesses and the foreign globalists, invaders and jews.

The Nat Soc guerrilla is an implacable enemy of the regime, and systematically inflicts damage on the authorities and on the people who dominate the country and exercise power. The primary task of the urban guerrilla is to distract, to wear down, to demoralize the zionist regime and its repressive forces, and also to attack and destroy the infrastructure and property of the foreign elite and the race traitors.

The Nat Soc guerrilla is not afraid to dismantle and destroy the present economic, political and social system, for his aim is to aid the rural guerrillas and to help in the creation of a totally new and revolutionary social and political structure, with the armed population in power.

The urban guerrilla is characterized by his bravery and his decisive nature. He must be a good tactician, and a good marksman. The urban guerrilla must be a person of great cleverness to compensate for the fact that he is not sufficiently strong in weapons, ammunition and equipment.

The career military officers and the government police have modern weapons and transport, and can go about anywhere freely, using the force of their own strength. The guerrilla does not have such resources at his disposal and leads a clandestine existence. The guerrilla may use false documents.

Nevertheless, the guerrilla has an advantage over the conventional military or the police. It is that, while the military and the police act on behalf of the enemy, whom the people hate, the urban guerrilla defends a just cause, which is the people's cause.

The urban guerrilla's weapons are inferior to the enemy's, but from the moral point of view, the urban guerrilla has an undeniable superiority. This moral superiority is what sustains the urban guerrilla. Thanks to it, the urban guerrilla can accomplish his principle duty, which is to attack and survive.

The urban guerrilla might have to capture or steal weapons from the enemy to be able to fight. Because his weapons are not uniform—since what he has are expropriated or have fallen into his hands in various ways—the urban guerrilla faces the problem of a variety of weapons and a shortage of ammunition. Moreover, he has no place in which to practice shooting and marksmanship. These difficulties have to be overcome, forcing the urban guerrillas to be imaginative and

creative qualities, without which it would be impossible for him to carry out his role as a revolutionary.

The guerrilla must possess initiative, mobility and flexibility, as well as versatility and a command of any situation. Initiative especially is an indispensable quality. It is not always possible to foresee everything, and the guerrilla cannot let himself become confused, or wait for instructions. His duty is to act, to find adequate solutions for each problem he faces, and to retreat. It is better to err acting than to do nothing for fear of making a mistake. Without initiative, there is no guerrilla warfare.

Other important qualities in the guerrilla are the following: to be a good walker, to be able to stand up against fatigue, hunger, rain or heat. To know how to hide, and how to be vigilant. To conquer the art of dissembling. Never to fear danger. To behave the same by day as by night. Not to act impetuously. To have unlimited patience. To remain calm and cool in the worst of conditions and situations. Never to leave a track or trail. Not to get discouraged. In the face of the almost insurmountable difficulties in guerrilla warfare, sometimes bloodbrothers weaken and give up the fight.

The guerrilla is not a businessman in a company, nor is he an actor in a play. Urban guerrilla warfare, like rural guerrilla warfare, is a pledge which the guerrilla makes to himself. When he can no longer face the difficulties, or if he knows that he lacks the patience to wait, then it is better for him to relinquish his role before he betrays his pledge, for he clearly lacks the basic qualities necessary to be a guerrilla.



III. Guerrilla Tactics



1. The Art of Guerrilla Warfare

Guerrilla warfare is an effective method to resist and outflank the enemy who otherwise would have both the numerical advantage and the resources to shut down organised opposition. Taken together with other political activities such as graffiti and leaflets it poses an imminent and large threat to the status quo. There is no specific way to instruct a cell how to best wage warfare against the jews and their cronies, so lessons must be learnt from literature focused on urban combat and rural resistance. Sniping and isolated acts of guerrilla warfare are best to approach the task of weakening and de-legitimizing the current government.

2. Sniping and Marksmanship

The ultimate guide to sniping is the Precision Rifle B.I.B.L.E Volume 1 and 2 by Nicholas Irving. After reading it you will be an expert. An excellent guide to Urban Sniping specifically is Fry The Brain by John West. Be sure to consult it as a resource when training your cell or yourself in sniper warfare, or when planning an assassination mission.

FM 23-10 Sniper Training

<https://www.myarmypublications.com/images/FM2310.pdf>

<https://archive.org/details/milmanual-fm-23-10-sniper-training>

1. Marksmanship
2. Field Techniques
3. Tracking/Countertracking

3. Combat Skills

“The first step toward determining appropriate targets, objectives, and other supporting efforts is to establish an understanding of the enemy’s capabilities and intentions. Key questions include the following: ☐

What are the enemy’s tactical, operational, and strategic capabilities and efforts to ensure control over the population?

What are the enemy’s centers of gravity? ☐

What are the enemy’s psychological vulnerabilities? ☐

Where is the enemy vulnerable to guerrilla or underground operations? ...

Before a resistance organization can successfully engage in combat operations, its leadership must organize an infrastructure that can sustain itself in combat and withstand the anticipated hostile reaction to armed resistance. During the organization phase, the resistance leadership develops a cadre to serve as the organizational nucleus during the buildup phase.” – FM 3-18 Special Forces Operations

An excellent book covering unarmed, armed and ranged combat is 1001 Street Fighting Secrets by Sammy Franco (1997, Paladin Press).

It should be used as a training manual for any Nat Soc guerrilla force.

4. Basic Security

Good security minimizes the possibility of being surprised and the consequences of being surprised. Loose lips in warfare get people killed.

Compromises of operational information may occur hundreds of miles from the operational area. Personnel should take the following precautions: ☒

Limit the use of proper names with resistance members. Soldiers should not share personal information with indigenous resistance personnel.

Provide code names for all coordinators. This allows secure and unsecure communication regarding personnel.

Keep operational information on a need-to-know basis.

Maintain internal communications procedures that indicate a compromise of information.

Keep information on a need-to-know basis. Play it close to the vest, especially about upcoming operations. Ease new members into positions of trust. Give them small amounts of information at first, and listen for it being repeated by anyone.

Enforcement of security procedures should be one of the highest priorities, with reprimands and other punishments administered equal to the offense.

Watch what you say on radios and telephones. Presume all transmissions are being monitored – even when you're on hold. Do not openly discuss any of your activities!

Your unit can initially masquerade as a paint-ball team, which justifies the people in fatigues. Web gear, helmets and guns should be brought to exercises in duffel bags.

Avoid storing incriminating tools or other equipment in your home or vehicle. This includes maps and documents. Use a safe house, storage locker or hide them in the woods.

Avoid predictable patterns. Vary the days, nights, locations and methods you use.

When on missions, do not carry IDs, wallets, key rings or anything that might identify you.

Security Oaths

Throughout history, secret groups have reinforced group cohesion with the use of secrecy and loyalty oaths. It is important that members openly and directly declare their willingness to protect one another. Psychologically, the act of swearing loyalty is of far greater value than the assumption of the same. The memory of the event can give that added ounce of strength under enemy questioning, when most groups come unraveled.

The Guerrilla Soldier's Oath

I do swear, before God and the personnel assembled, that I will:

- Follow the orders of my leaders to the best of my ability.
- Keep the identities of all my fellow soldiers a secret and not give in under threats, torture or prison to the point of death.
- Keep all knowledge of militia activities and resources a secret to the point of death.
- Not abuse my authority or the power of my weapons.
- Be a friend of the common citizen.
- Never forget that I am the last hope of freedom.

Individual Physical and Mental Fitness

Before we can defeat the jews in the World Bank and the jews in Hollywood, we must first defeat the jews within ourselves.

Go to the gym or start a body weight routine. Don't neglect cardio, go for a morning run. Take a cold shower. Get 7-9 hours of good quality sleep every night, avoid stimulants in the late afternoon. Become a morning person and get up early.

https://hooktube.com/watch?v=XtDc_iJ-j-M

Hygiene is important. BRUSH YOUR TEETH TWICE A DAY FOR 2 MINUTES, don't forget to floss. Make your own toothpaste. Get a tongue scraper too. Your tongue should be a nice pink color, not white or yellow. This is not some ancient, long forgotten secret, but it's amazing how many people neglect oral health - it's just as important as lifting. Deodorants containing aluminium salts are toxic, avoid their use at all costs. You can make your own spray from baking soda, water and a few drops of a nice smelling essential oil. This will stop body odour without making you sterile.

Lower your carb intake and eat more animal fat. Eat lots of organic meat and fish. The (((food pyramid))) overestimates the amount of carbs you should be eating - stop consuming excessive amounts. Do not eat feminized products such as soy. Treat yourself to an occasional glass of good red wine, or a small portion of high cocoa dark chocolate. Try intermittent fasting, a simple 18/6 routine can work wonders.

Do not breed with whores. Find a wholesome wife. Do not expect to meet a wholesome girl in a bar, nightclub or university campus. Plan a family. Raise strong men and respectable women who will lead in the war.

Meditate. It calms the mind, builds discipline and is an ancient, tried and tested method of building mental clarity, control and spirituality. Start today, it only takes 10 minutes. <https://hooktube.com/watch?v=Q-L2ZKYMsag>

Respect yourself and your race. Don't humiliate your women with the degeneracy of feminism.

Stop consuming (((pornography))). Oh, you think that you're not addicted to porn? Prove it. Try to go without porn or masturbating for a whole week or two. Then aim for a month. It's harder than you think. <https://hooktube.com/watch?v=wSF82AwSDiU>

<https://hooktube.com/watch?v=7oFVOJf0TzY>

Quit playing video games. Do something productive, write something or build something. Plan your career, climb the ranks or start a business. Learn something useful.

We need more strong, kike-free men in positions of power.

Now get off the internet, go outside and get some sun. Go for a hike. Go camping. Join some wholesome clubs and make some normal friends. Do not reveal all your true knowledge to plebs, drip feed them redpills. Stop smoking cigs and don't do drugs. Don't watch degenerate (((media))) and read some good books. You can easily source used books cheaply from local stores or online.

<https://www.abebooks.com/>

<http://gutenberg.org/>

Work towards owning property and/or land. Don't waste your time and money buying new cars on finance, it is a jewish trick. Save 10% of your income for a rainy day, even a little will go a long way. Stash some money in safe alternate forms, like silver and gold. Maybe a little crypto too, but be cautious.

Become informed on prepping and homesteading, make sure you're ready when shit hits the fan.

This is your life now.

Physical Fitness for Group Training

The combat soldier is tough, but the average citizen is soft. Your job will be to whip your group into fighting shape in a short period of time. Far too many will want to depend on their weapons. It is important that partisans realize how being physically fit is in their best interest.

Attaining physical fitness is not an overnight process. The body must go through two stages. First is the toughening stage which lasts for about two weeks while the body goes through a soreness and recovery period, The second stage is slow improvement. Blood circulation improves, and the body becomes more efficient. The body reaches its maximum level

of performance between six and ten weeks of daily exercise. This physical peak should then be maintained.

Supplement your workout routine with standard pushups, running and obstacle courses.



Basic Strategy and Tactics: Field and Urban

“While the three classical levels of war carry over into the Fourth Generation, they are joined there by three new levels which may ultimately be more important. Colonel Boyd identified these three new levels as the physical, the mental, and the moral levels. Furthermore, he argued that the physical level - killing people and breaking things - is the LEAST powerful, the moral level is the most powerful, and the

mental level lies between the other two. Colonel Boyd argued that this is especially true in guerrilla warfare. [...] This leads to the central dilemma of Fourth Generation war: WHAT WORKS FOR YOU ON THE PHYSICAL (AND SOMETIMES MENTAL) LEVEL OFTEN WORKS AGAINST YOU AT THE MORAL LEVEL. It is therefore very easy to win all the tactical engagements in a Fourth Generation conflict yet still lose the war.” - From "4th Generation Warfare Handbook" by William Lind

Otto Skorzeny in his book *My Commando Operations* lays out practical examples of wartime manoeuvres. Additionally, various Field Manuals from the US military delve deeply into tactics and strategies necessary for continued military success. Here a basic introduction into guerrilla warfare will be provided.

The Strategy

The following strategy has proven effective for guerrilla warfare.

- When the enemy advances, we retreat.
- When the enemy camps, we harass.
- When the enemy tires, we attack.

The Tactics

Know your enemy. Become familiar with all the branches of law enforcement and military units in your area. Know the numerical size of the enemy units and their fire-power. Know the enemy's response time and avenues of approach. Know their strengths and weaknesses. Learn to recognize all their vehicles and monitor their communications.

Attack the enemy at his weak points. The enemy cannot be strong everywhere. Seek and find the decisive targets.

Attack only when you have a 95% probability of victory. Good reconnaissance, superior fire-power, speed and controlling the time and place of the attack increase your chances of success.

Never set patterns. When a method works, use it. But do not continually use the same method of operation. Vary your appearance, your vehicles, methods of obtaining supplies, avenues of attack, retreat and the types of targets you attack.

Strike where you are least expected. Many times the most important target is weakly defended. Look for over-confident guards, or those who have been the same job for too long and their guard is down.

Never hesitate to use your most powerful weapons. When the shooting starts, don't hold back. Go for the jugular.

Always out-gun your enemy. Being the underdog may win sympathy, but won't win battles. Stack the deck in your favor with numerical strength of at least three, but preferably four, to one over the enemy.

Limit the length of enemy contact to three minutes. Engaging the enemy for longer times will allow them to radio for help, and force you into a defensive position. Shoot and scoot.

Never voluntarily take a defensive position. A defensive position is one where the enemy has you boxed in. Either attack or withdraw. If you are attacked, unleash your most powerful weapons, neutralize the attack and relocate.

Do not allow the enemy freedom of movement or to make decisions. Mobility is life for an army. When that mobility is lost - so is the battle.

Do not allow the enemy to bring their weapons to bear. This will push you into the defensive. Work fast.

Always prepare backup forces and vehicles. When the enemy begins to tire, bring in your reserves 10 finish them off.

Allow for unforeseen problems. Anything can happen once the shit hits the fan. Stay flexible and adapt to the situation.

Never waste personnel or resources by attacking just to be attacking. Analyze the war and battle situation as a whole, find the decisive targets and get them.

5. Mission Planning and Execution

Before you go out on a mission:

- **Terrain.** Make a thorough map study. Make note of critical features as reported by other patrols. Note positions for observation and concealment. Roads and trails. Streams, width, depth, current, underwater obstructions . Bridges and crossing points. Footings in swamps and quagmires. Woods and thickets. Obstructing vegetation such as cactus, brambles poisonous plants. Thickness and supporting qualities of ice and snow.
- **Weather.** Forecast. Moon Phase. Time of darkness and daylight. Expected day and night temperatures throughout mission.
- **Enemy.** Strength, dispositions, activity by day and night. Locations of weapons, fieldwork's, obstacles, minefields, sentries, warning devices. Use and meaning of flares. Patrols; protective cover fire (artillery, aircraft). Attitude, morale, peculiarities. Are prisoners to be taken'?
- **Civilians.** Presence in area. Attitude. Assistance possible-- trustworthiness. Alerts by domestic animals--barking dogs; alarms, etc.
- **Own Troops.** Other partisan activity. Supporting fires, Other support - transportation, communication, medical. Patrols, minefields - gaps through.
- **Equipment and Supply.** Special weapons and equipment--sniperscope, radio, binoculars, wire cutters, rope, mine detector, night vision. Ammo, pyrotechnics, water, rations.

- Control. Challenge and password. Prearranged code. March objectives, checkpoints. Messages - when and where. Plan A, B, C.
- Make Tentative Plan. Study map--is it up to date? Study enemy situation and its effect on mission. Determine the need of supporting fires and other support. Decide strength of patrol. Select weapons, amount of ammunition, special equipment.
- Coordinate With Others. Other partisan units, representatives of other supporting units. If practical and possible, check to ensure that adjacent units and friendly patrols are told of your route, objectives and general plan of operation. This will avoid accidental exchanges of gunfire and resultant casualties.
- Select Your Personnel, A qualified second in command. Smallest number of personnel essential capable and in good physical condition. No colds, sneezers or coughers. No one with night blindness. If necessary, some swimmers, linguists. First aid person. Guides.
- Issue Warning Order. Tell your personnel that mission is coming and timetable. Brief statement of situation. Organization of the patrol. Direction to all persons concerning weapons, equipment, uniform, removal of identification, to draw special items, ammo, rations. Camouflage. Who second in command is. Who will accompany you on mission. Assembly time.
- Review Reconnaissance. Meet with second in command. Check tentative plan against terrain, situation, enemy capabilities. Select route out and alternate route of return. For night patrol, memorize critical terrain features.
- Complete Your Plan. Think over possible plans and check against contingencies. If there is time, make rough sand model of terrain for checking plan. Include provisions for care of wounded. Consider assembly points. Make notes for Patrol Order.

- Final Coordinating. Mortars, artillery, friendly outposts. Latest enemy information. Any additional special equipment.
- Issue Patrol Order. The patrol leader first gives a terrain orientation, then mission instructions.
- Rehearsal. For night patrol, rehearse once in daylight and once at night. Emphasis on personnel knowing routes, assembly points, what to do on enemy contact, what to do at mission objective. How to orient on terrain, by compass, by stars, how and when to fire weapons at night.
- Inspect Patrol. Faces and equipment camouflaged. Sleeves and pant legs taped or strapped. Have each person jump up and down to check for rattles. Nothing shiny. Canteens filled {check to make sure}. Fresh batteries in radios. Tuned to proper channels. Compasses checked for accuracy. Synchronize watches. Other items complete and in working order.
- Conduct Patrol / Mission. Get there - get it - and get back!
- Mission Report. Share new information with your senior officers and if needed, with friendly units. Issue propaganda release detailing damage done and hopeless position of enemy.

Breaking Out of Encirclements

When surrounded, stage your breakout as soon as possible. The longer you wait the stronger the enemy will become.

Form your personnel up in the shape of a triangle, with a wide base as your front. This shape will work with groups of from five to twenty people. If you have full auto or selective fire weapons, you should put them in the first two rows (set on full), with semi-autos making up the tail point of your triangle.

At the decision to move out, throw White Phosphorous grenades or smoky Molotovs plus pipe bombs, toward the rear and to each side; and grenades or other explosives to the front.

Following the explosions, move forward immediately with the first row firing until their magazines are empty. Then they should go to ground and change magazines while the second row advances, also firing on full automatic. After the second row empties their magazines, the first row should be back up with weapons on semi-automatic and firing as they move.

All weapons should continue to be fired until everyone clears the encirclement.

6. Interrogation

After combat you may capture prisoners. Detailed interrogation methods are outside of the scope of SS Paladin (though will be elaborated on later) so consult Interrogation: Science and Art by Intelligence Science Board among other in depth guides to getting the most out of your interrogation.

7. Counter-Intelligence

Successful insurgent leaders have identified effective counterintelligence (CI) planning, tradecraft, and implementation as essential for the continued survival of insurgent groups and for their eventual development and advancement. Typically threatened at every turn by more numerous and robust government means, resourceful guerrilla counterintelligence cells in every area of the world have sought to devise approaches and actions that neutralized the intelligence organizations and activities arrayed against them.

It has been a prerequisite for carrying out the organization, concealment, recruiting, arming, financing, planning, and execution of operations by dissident armed groups. All insurgent groups – incorporating variations in concept and nuance – recognize the need to protect their forces from the hostile action of enemy intelligence initiatives and to degrade the intelligence and security components facing them.

As a consequence, insurgent counterintelligence – like its government counterparts – has both defensive and offensive components that range from the most passive security measures and admonitions for exercising discretion, to aggressive direct actions targeted against enemy intelligence personnel and resources.

Security Culture: A Handbook for Activists by the Earth Liberation Front or The Animal Liberation Primer by Animal Liberation Front are good guides to understanding governmental tactics for control and suppression. Further resources can be found in the Endnotes of Guerrilla Counterinsurgency (JSOU Report 09-1) by Graham H.

Turbiville.

How do the Bandidos motorcycle gang conduct their CI operations?

- a) Corruption of public officials through bribery and coercion to further criminal endeavors
- b) Coercion of law enforcement with direct violence and threats
- c) Exploitation of law enforcement as intelligence sources
- d) Focused countersurveillance of police to include videotaping
- e) Mobilization of police Internal Affairs against officers (using selected measures—e.g., video/audio clips and proliferating false reports)
- f) Induction of members (sometimes acquired from the many Bandido “support group” clubs) whose lack of criminal history allows the presentation of a “clean” face in pursuing their interests.

Central Intelligence Agency (CIA) officer Carlos Revillo Arango, in an instructive article entitled “Insurgent Counterintelligence,” categorized the range of threats faced by the guerrilla to include:

- a) Government security forces and targeted actions of all types
- b) Competing armed or dissident groups who might enjoy advantage from the defeat or compromise of a rival
- c) Third-country parties whose unilateral actions might damage or restrict insurgent operations
- d) Betrayal—deserters, collaborators, and informers from within the group who may act out of jealousies, perceived slights, coercion, or profit—and because of their special knowledge can generate devastating damage
- e) Chance occurrences to include carelessness, unrelated changes in government routine (e.g., curfews, identifications, and checks), and even natural disasters.

Insurgents who were successful—or at least survived to record their views—often lived in a world where threats like these proliferated, and they were hunted constantly. Betrayal was a daily potential, and developing a sense of near paranoia often constituted wisdom. Despite advances in technology that put insurgents at greater risk from the pre-World War II period to date, the greatest danger has remained the “turned” insider.

Alberto Bayo, a life-long guerrilla instructor and leader identified the following issues as integral to guerrilla CI:

- a) A guerrilla “Information Section,” headed by the second-in-command of the group, must be established to handle intelligence and counterintelligence functions and activities. It should be composed of small cells to mitigate damage and larger compromise. In addition to gathering “positive” intelligence of all types [there clearly being at least as much overlap with CI for guerrillas as there is for governments], it will carefully monitor the conduct of group members, record all large and small wartime activities, maintain lists of outside sympathizers and blacklists of known or potential informers, and maintain a coding/decoding center.

These activities, along with the investigation of traitors, were noted by Bayo as suitable for both male and female guerrillas.

b) Intelligence and counterintelligence work must be accomplished by all guerrillas. But the counterintelligence agent, per se, has pride of place among guerrillas in wartime, giving “better results than the intelligence agent.” The CI agent—for which task women are “unbeatable”—penetrates enemy organizations and areas masquerading as a friend and sympathizer, often acting as a seller of provisions and other merchandise at a low cost. Relying on observation alone and not asking questions, he or she reports troop levels, strength, movement, equipment, and morale. Training of such agents must be well done. Reports are generated in code by a third party or by messenger where there is urgency. In the event of a guerrilla attack, guerrilla CI agents should pretend to fight in behalf of the enemy, but avoid causing any damage to guerrilla forces.

c) The potential for having a guerrilla CI operative who is an officer in the enemy forces is prized. Such an operative can be more valuable to the guerrillas than “ten of our own officers fighting face to face with the enemy.” Not only will he be able to provide quality information but he should seek combat assignments that allow him to create vulnerabilities that guerrillas can exploit (e.g., leading government forces into ambush and arranging for undermanned garrisons). The formation of “private” armed groups—that is, militias—seemingly friendly to the state but actually in collaboration with the guerrillas is another possibility (actually practiced against the Cuban Batista regime).

d) Regarding intelligence and counterintelligence and underscoring their importance to the guerrillas, the view was asserted that “more wars are won through cunning and shrewdness than by pulling the trigger ...”

e) Recruits for the movement must be fully vetted to include filling out applications that provided information on their families, personal political history, and references within the revolutionary movement itself. If determined to be a potential informer, “he will be judged by a summary court martial as a traitor to the revolution.” Recruiting and the acceptance of volunteers were considered a critical potential vulnerability.

f) If the movement is infiltrated by a “chivator” (informer)—who despite all the efforts made to screen recruits successfully penetrates it—he will be judged by a Council of War and sentenced to death. Political enemies outside the movement might be pardoned for their mistaken beliefs, but a chivator will be executed.

g) The group must be alert to enemy forces masquerading as supporters (e.g., government pseudo-operations). One example of such a group was a column that shouted “Viva Fidel” upon encountering the insurgents and then surprised them by pulling out weapons, coercing their surrender, and then executing all of the captured guerrillas except a seven-man advance guard that managed to escape.

h) Before attacking a town or population center, a list of traitors and “persecutors” and their addresses should be compiled by the guerrilla Information

Section (Intelligence and Counterintelligence) including their addresses, and this should be provided to the guerrilla Operations Section.

i) The maximum size of guerrilla cells should be three people to avoid the compromise of larger numbers if a member is turned or compromised. Any cell of 8–10 guerrillas whose members also head other groups of the same size should be dissolved.

j) Careful attention should be directed towards how executions for “counterrevolutionary acts” or crimes are carried out. As large a crowd as possible should witness the event, and a guerrilla leader should address them with an explanation of what the prisoner had done to deserve a death sentence and emphasize how the moral qualities of the guerrillas are superior. The execution should be a “public spectacle” accompanied by the promise to carry out swift justice against any malefactor in the future.

k) Arms and equipment caches should receive close oversight for their physical security and danger of compromise by individuals. Caches should be buried deep, to a depth sufficient to avoid detection by enemy forces, even if they dig in the area. Rural guerrillas should locate caches at a distance of some 30–60 yards from a farmhouse or dwelling. Close uniformity in approach, however, should be avoided so that government personnel cannot establish patterns.

l) Despite the unflinching punishment of traitors and informers, moderation should be used with the “lackeys” of the oppressor “that the people want to kill.” Rather, such individuals should be allowed a defense, with consideration given also to the possibility that a suspect may be a “counterspy” working in behalf of the revolution and only appearing to work with the state.

Michael Collins of the early IRA contributed the following to CI theory:

a) Informers and spies operating in behalf of the state—including those recruited from rival groups—pose the greatest threat against an armed resistance movement.

b) Friendly (republican militant) intelligence structures must be better prepared and organized than those of opponents and protected by organizing into cells, each with limited knowledge of the other participants.

c) Friendly spies and informers with good access must be placed or recruited among all communications, transportation, and other organizational (trade union) and infrastructure administrative elements.

d) Enemy intelligence itself must be studied and understood in every dimension, the better to protect one’s own resources and to exploit adversary vulnerabilities.

e) As a central guiding precept, it was stressed that while casualties among enemy soldiers could be replaced with relative ease, intelligence operatives and spies supporting British efforts were exceptionally high value resources whose loss would be difficult or impossible to offset.

f) The identification of key enemy intelligence personnel individually and groupings whose loss would be particularly harmful should be a priority task for

IRA intelligence.

g) Once identified, enemy intelligence operatives should be threatened and coerced into stopping or compromising their activities.

h) If the threatened police operatives do not comply, they should be killed.

i) Police and paramilitaries who commit crimes against IRA personnel or advocate oppressive policies should be eliminated, even long after the fact.

j) A highly secretive assassination section was necessary to carefully study layouts, plans, timing, and personal attributes of the targets before assassinations, with provisions made for the disposal of the weapons used.

k) Individual members should foster visual or other identification with British or non-republican perspective to ease movement and allay suspicion.

Al Qaeda released a study of the U.S. Intelligence Community called *The Myth of Delusion* by Muhammad Khalil Al-Hakaymah. Additionally they released *Management of Savagery* by Abu Bakr Naji another look at their enemy, the USA. Another resource to consider perusing is *Military Studies in the Jihad Against the Tyrants*. For technical advice consult the latest edition of the *Technical Mujahid* publication. The competent treatment of tribal, religious, and ethnic groups—whose support and participation in an insurgency is a point of consideration—has sometimes been ignored by aspiring insurgents or terrorist armed groups. The much publicized disaffection and eventual intense hostility developing among some Iraqi insurgents and Al Qaeda in Iraq is only a recent manifestation of the problem faced by some insurgencies.

While once making common cause against the U.S.-led multinational coalition, the later operational and intelligence difficulties encountered by foreign fighters have been manifest. This problem is recent but not unique to some insurgencies. One consequence for guerrilla groups who were not properly prepared to deal with cultural issues has been to undermine the creation of informant networks and to leave an indifferent or hostile population base that materially harms guerrilla efforts.

This appears to have been the case for Che Guevara in Bolivia—perhaps the best known popular illustration—where he noted in his diary that his group had learned Quechua, but that the local tribal language in his area of operations was Tupí-Guaraní. The consequence of this, as he noted, was a lack of rapport between the guerrillas and the Indians, great difficulties in recruiting, and the existence of a population base that might be inclined to inform authorities about his activities. This situation had a substantial impact on Che's activities and could plausibly be judged as a significant factor in his eventual failure.

A similar story occurred in Peru where the National Liberation Army insurgency did not learn the local Quechua dialect but spoke in Spanish, leading them to being seen as arrogant and bossy. Hand in hand with the language shortfalls was the lack of appreciation for Indian customs. Béjar emphasized that simple good works were not enough, even though they might be appreciated. Good works could be negated, and were, by the guerrillas' failure to exercise discipline in their conduct around the Indian populace. They did not steep themselves in Indian habits and offended them with seeming arrogance

and unknowing insults to their feelings and sensitivities. This, like language deficiencies, created CI dangers for the guerrilla force, even as the guerrillas thought they were winning their appreciation by forming various services.

Defensive CI Practice

A major effort of any insurgent forces requires a focus on denying enemy knowledge of its leadership, organization, location, support structure, and planning. Devastating failures are typically more notable than successes, and those guerrillas who survived or witnessed them have contributed to the accumulated guerrilla counterintelligence “wisdom” noted above. CIA officer Carlos Revilla Arango in his useful article “Insurgent Counterintelligence” identified several key defensive CI considerations. These included the recognized need for compartmentalization, careful security in recruiting, communications security, protecting identities, and exercising control over cadres as well as among the principal areas, and one may identify others as well.

In Uruguay during the 1960s and 1970s, the Movimiento de Liberación Nacional (National Liberation Movement—MLN) guerrilla movement was confronted by the state police and military forces increasingly intense and brutal efforts to destroy it. The Marxist guerrillas, better known as the “Tupamaros” after the 16th century Incan warrior and leader Tupac Amaru, were followers of the doctrines promulgated by Brazilian Carlos Margehelli and were a relatively disciplined movement. In accord with good practices of compartmentalization, the Tupamaros were organized into cells of two to six members who did not know each other’s real identities (using aliases or “war names” instead). Cell leaders reported to a hierarchical leadership and had either combatant/commando or support responsibilities of various types. The arrest and successful interrogation of a single member or leader reduced the prospects of the entire cell or even several being rolled up. To avoid compromise by introducing informants into the structure, recruiters relied on personal sponsorship of recruits, detailed application information, and background checks with friends, neighbors, and others. The Tupamaro recruiters sought to identify what might be called the presence of a “guerrilla temperament” to a greater extent than many other groups, assessing psychological traits as well as competence in basic skills needed by insurgents. Recruits were provided with written instructions on how to conduct themselves and cautions on the need for discreteness.

Regarding FARC in Colombia, they started the digital era strong. The chief of the Colombian General Staff had noted, for example, that USB flash/thumb drives and computer disks have been disseminated by messenger rather than transmitted out of fear of interception (a sound enough practice). However, the intelligence and counterintelligence successes that were more manifest in earlier years began to fray visibly in the 21st century.

Most recently, the FARC’s extraordinary setback with the 2 July 2008 rescue of 15 FARC hostages seemed to mark its growing intelligence and leadership disarray. In substantial ways this was

a multiple counterintelligence failure for the FARC just as it was a success for Colombian military intelligence. Codenamed Operation Jaque (Check [mate]), the hostage rescue appeared to highlight Colombian intelligence/CI innovation and FARC intelligence/CI indiscipline. The Colombian intelligence penetration of the FARC Secretariat and lower levels, exploitation of communications indiscretions, computer forensic and document exploitation, psychological manipulation, and the final deception of the FARC group assigned to guard the hostages would have seemed highly improbable a few years ago. While the operation will be examined closely and new details and interpretations emerge, the CI object lesson for guerrilla groups seems clear enough and are echoed in the calls for tight discipline, continuous suspicion, protection of all forms of communications, review of personnel qualities, and other imperatives practiced by most surviving or successful groups.

Surveillance of meeting places, safe houses, camps, and other locations makes a list of concerns for most insurgent groups. For the most astute and experienced groups, the requirement to maintain a near paranoid suspicion of everything in one's environment has also been acknowledged. Failure in these things has been commonplace, however, typically caused by inattention, overconfidence, miscalculation, or just bad luck.

General Sir Frank Kitson described three factors that could be used to induce a man to shift his loyalty and that he tried to apply:

- a) A "carrot" in the form of a positive incentive that has real attraction
- b) A "stick" in the form of a disincentive, which makes him realize that continuing on the same course will result "in something very unpleasant happening to him"
- c) A chance to demonstrate to his family and friends "that there is nothing fundamentally dishonorable about his action" of turning against the insurgents, and that he retains his self-respect.

Offensive CI Practice

Offensive counterintelligence activities by guerrillas and other armed groups fall most closely into what the U.S. joint military definition terms counterespionage—the component of CI concerned with various kinds of aggressive and more subtle actions aimed at detecting, destroying, neutralizing, or otherwise influencing hostile intelligence activity aimed against them.

Many insurgent groups have used direct attacks and coercion against opposing intelligence and security personnel. The Tupamaros, for example, had a concept of "direct" and "indirect" approaches that to most eyes would both seem rather direct. In the former, a primary insurgent CI target like a government intelligence officer would be shot or otherwise killed. In an indirect approach, someone close to the target would be eliminated—for example, a bodyguard or assistant.

In a far different theatre, the Moro based Abu Sayyaf Group in the southern Philippines has long bribed and coerced local police officials. They also undertook a series of direct actions against intelligence personnel. These involved the kidnapping of three suspected intelligence personnel and informants and execution of another.

Few armed groups have translated a concept for offensive counterintelligence into practice as well as Michael Collins and the Irish republican militants. His rationale was reasoned, clear, and intensely personal about his targets: To paralyze the British machine it was necessary to strike at individuals. Without her spies, England was helpless. It was only by means of their accumulated and accumulating knowledge that the British machine could operate.

An accompanying goal was to so outrage and frustrate British security officials that reprisals would be out of proportion and would alienate even larger segments of the Irish populace. Michael Collins' intelligence organization was well designed and manned for this principal purpose—to collect key information through its networks of well-placed typists, clerks, policemen, businessmen, waiters, desk clerks, transportation workers, and others who provided the most sensitive inside information from the British security together with outside observations that were essential too. All of the limited technical means available at the time were used. The information provided enabled the Volunteers (IRA) operational arm to attack and eliminate not just intelligence personnel in general but those individuals most important to the British intelligence-gathering operations. To accomplish this mission, every Volunteer company had a dedicated intelligence officer who reported to a brigade intelligence counterpart. The latter was subordinate to the man who ran the day-to-day operations at Volunteer intelligence headquarters, this under the oversight of Michael Collins. The subordinate officers recruited agents and informers who fed information to HQ used in targeting key intelligence personnel. At intelligence HQ—which was nicknamed the “Brain Center” and where key staffers became known as the “Inner Circle”—intelligence officers had specific areas or businesses to know about and assess, and fragmentary information was pieced together and analyzed.

Assassinations were carried out by a group that came to be known as the “Squad” and also nicknamed the “Twelve Apostles” in a touch of black humor. The group functioned as a subcomponent of the Volunteer/IRA intelligence staff and was made up of local Dublin men who had worked regular jobs of one sort or another. Some core members were required to quit their regular jobs and became full-time compensated members of the team. They guarded their identities, sympathies, and affiliations carefully even from other Volunteer/IRA members. Police intelligence and a few others who were identified as being particular threats were warned to cease their activities or at least to become far less diligent. If they acquiesced, they were spared, but if not cooperative they were selected for execution. Target areas were reconnoitered, and the subjects of the executions identified by one or more people who recognized them. Squad members typically

operated in from one to several pairs of assassins for each target and might have several support personnel for surveillance, identification, and logistics. After an intelligence officer identified a target for assassination, shooters followed or approached him at an opportune place and killed him with handguns. While many variants were in practice, one shooter would fire in an effort to stop and disable him, and the other would shoot him in the head to ensure he was killed.

Israeli reporting

indicates that Hezbollah has used the popular social networking system “Facebook” to gather information on Israeli Defense Force (IDF) personnel. IDF members have been cautioned about posting personal and potentially compromising information online, and the dangers have reportedly been incorporated in security awareness training. An IDF soldier who served in an intelligence unit was sentenced in the late summer of 2008 to 19 days in a military jail for posting a photo of his base on Facebook. A further concern has been the possibility of terrorists establishing online friendships or arranging direct meetings with military personnel to all the attendant dangers this would pose. The further use of Facebook by Hamas terrorists and supporters during the IDF punitive operation in Gaza, to end rocket attacks, reinforced the concern. Facebook was used for disinformation purposes as well as for fund-raising.

Conclusion

Guerrilla counterintelligence efforts most typically have both defensive and offensive components. Neither one component nor the other is usually judged adequate for providing the operational freedom and security required to pursue active initiatives. On the defensive side, sometimes elaborate guidelines dealing with general conduct as well as with specific operational security requirements are developed and incorporated into recruiting and training programs. More sophisticated groups use background and character investigational approaches that may be as strenuous as government security vetting and perhaps more so given the consequences. Insurgent and terrorist groups actively obscure their locations, capabilities, planning approaches, and intentions from active and potential adversaries. The practice of deception, cover story fabrications, forged papers, false identities, and the many other tradecraft practices have become systematized in some groups and practiced with skill.

The serious and sensitive danger of infiltration and betrayal hangs over the heads of most guerrilla organizations. Frequent loyalty tests and vigilance approaching paranoia are real survival skills. While it hardly bears noting—given the richness of precedent from European, Asian, Latin American, Middle Eastern, and African groups—identified informants or spies are almost always killed as a matter of course. Some groups have elevated the need to make torture and the extreme violence of punishment for treachery so severe that these acts serve as object lessons for others who might contemplate straying. Security guidelines and procedures are as often as not written documents. They serve as training and reference sources for the guerrilla, on occasion seeming like the rules of normal

fraternal or social organizations into which large doses of violence, deception, and uncompromising hatred have been blended. Offensive components of guerrilla counterintelligence are in their most aggressive forms aimed at infiltrating vulnerable parts of government, military, and police intelligence organizations; buying, blackmailing, or otherwise coercing members; and in some cases targeting specific individuals or any member for execution. Old approaches like those of Michael Collins from eight decades ago may seem like ancient history, but the approaches used by Israeli Mossad against selected Islamic terrorist leaders and those used by terrorist groups themselves are striking in their similarity of process and technique.

The focused study and assessment of government, military, and police intelligence is highlighted particularly in jihadist writings, but guerrilla and terrorist groups—and even organizations like outlaw motorcycle gangs and animal rights advocates—have for years studied and tried to anticipate the approaches used by their adversaries. Guerrilla targeting of state intelligence and security forces may come to be a larger part of insurgent practice. Government analytical techniques, surveillance, and intercept capabilities and technological advances generally has made insurgent and terrorist group safety tenuous and operational freedom more and more constrained. As Michael Collins advocated with some success, not only does eliminating an enemy intelligence officer by coercion or assassination demoralize the security forces but it creates a greater reluctance among the population to cooperate with state authorities. From this perspective, what a state or populace may justifiably characterize as a terrorist event and coldblooded murder may in its more complete context be understood from the guerrilla insurgent's perspective as part of a “rational” counterespionage strategy. There is value in recognizing this context and any trends for a fuller understanding of guerrilla intentions and CI planning.

The acquisition and application of CI-enhancing technology is commonplace for insurgent groups today and recognized in the intelligence planning of most governments. Most recently, this has come to include the exploitation of social networking sites such as Facebook, YouTube, MySpace, and Twitter among others. They have proven to be of some utility to insurgents and terrorists in gaining knowledge of government security and other personnel—as noted earlier in regard to the IDF—as well as recruitment and alternate communications.

Excerpt from Counterinsurgency, Field Manual 3-24/ Marine Corps Warfighting Publication 3-33.5 Section IV. Counterintelligence and Counterreconnaissance

(pages 3–30, Headquarters Department of the Army, December 2006)

3-155. Counterintelligence counters or neutralizes intelligence collection efforts through collection, counterintelligence investigations, operations, analysis and production, and functional and technical services. Counterintelligence includes all actions taken to detect, identify, exploit, and neutralize the

multidiscipline intelligence activities of friends, competitors, opponents, adversaries, and enemies.

3-156. Insurgents place heavy emphasis on gathering intelligence. They use informants, double agents, reconnaissance, surveillance, open-source media, and open-source imagery. Insurgents can potentially use any person interacting with U.S. or multinational personnel as an informant. These include the same people that U.S. forces use as potential HUMINT sources. Operations security is thus very important; U.S. personnel must carefully screen the contractors, informants, translators, and other personnel working with them. Failure to do so can result in infiltration of U.S. facilities and deaths of U.S. personnel and their partners.

3-157. Background screenings should include collection of personal and biometric data and a search through available reporting databases to determine whether the person is an insurgent. (Biometrics concerns the measurement and analysis of unique physical or behavioral characteristics [as fingerprint or voice patterns].) Identification badges may be useful for providing security and personnel accountability for local people working on U.S. and host-nation (HN) government facilities. Biometric data is preferable, when available, because identification badges may be forged or stolen and insurgents can use them to identify people working with the HN government.

3-158. Insurgents have their own reconnaissance and surveillance networks. Because they usually blend well with the populace, insurgents can execute reconnaissance without easily being identified. They also have an early warning system composed of citizens who inform them of counterinsurgent movements. Identifying the techniques and weaknesses of enemy reconnaissance and surveillance enables commanders to detect signs of insurgent preparations and to surprise insurgents by neutralizing their early warning systems.

3-159. Insurgents may also have a SIGINT capability based on commercially available scanners and radios, wiretaps, or captured counterinsurgent equipment. Counterinsurgents should not use commercial radios or phones because insurgents can collect information from them. If Soldiers and Marines must use commercial equipment or unencrypted communications, they should employ authorized brevity codes to reduce insurgents' ability to collect

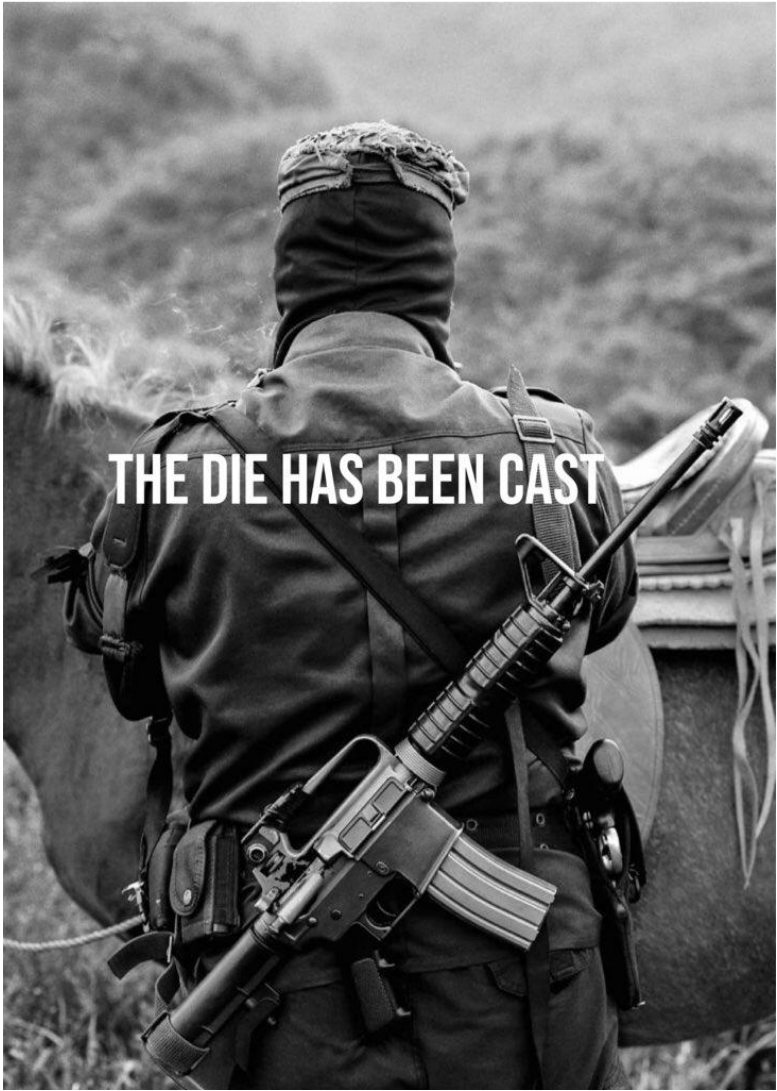

on them.

Read these

FM 21-75 Soldier Skills

<https://fas.org/irp/doddir/army/fm3-21-75.pdf>

1. Cover, Concealment, and Camouflage
2. Movement
3. Observation
4. Tracking and Counter-Tracking

FM 23-30 Grenades

<https://bulletpicker.com/pdf/FM%203-23.30,%20Grenades%20and%20Pyrotechnic%20Signals.pdf>
<https://archive.org/details/milmanual-fm-3-23.30-grenades-and-pyrotechnic-signals>

1. Fundamentals of Grenades
2. Utilization of Grenades
3. Tactical Employment of Grenades
4. Hand Grenade Safety Considerations (VERY IMPORTANT)

FM 90-10-1 Urban Combat Operations

<https://modernsurvivalonline.com/Files/books/fm/US%20Army%20FM%2090-10-1%20An%20Infantryman's%20Guide%20To%20Combat%20In%20Built-up%20Areas.pdf>
<https://archive.org/details/milmanual-fm-90-10-military-operations-on-urban-terrain-mout>

1. Fundamental Combat Skills
2. Employment and Effects of Weapons
3. Obstacles, Mines, and Demolitions
4. Subterranean Operations (Sewer Fighting)
5. Fighting Positions

6. Attacking and Clearing Buildings
7. Urban Building Analysis
8. Limited Visibility Operations Under MOUT Conditions (Night Fighting and Night Vision Devices)
9. Countering Urban Snipers (Police Snipers)
10. Close Quarters Combat Techniques (Room Clearance)
11. Field-Expedient Breaching of Common Urban Barriers (Doors and Walls)

8. Psychological Operations

Two guides cover the topic of Psychological Operations in guerrilla warfare very well: Psychological Operations in Guerrilla Warfare by Taycan and Special Forces Guerrilla Warfare Manual by Scott Wimberley.

Guerrilla warfare is essentially a political war. For this reason, its area of operations goes beyond the territorial limits of conventional warfare, penetrating the political being “par excellence” itself: the “political animal” defined by Aristoteles.

In effect, the human being must be considered as the priority objective in a political war. And viewed as the military target of guerrilla warfare, the most critical point of the human being is the mind. Once the mind has been reached, the “political animal” has been vanquished, without necessarily having received any shots.

Guerrilla warfare emerges and grows in a political environment; in the constant struggle to dominate that area of the political mentality which is inherent in every human being and which collectively constitutes the “environment” in which guerrilla warfare moves, and which is precisely the arena in which its triumph or defeat is defined.

This concept of guerrilla warfare as a political war turns Psychological Operations into the factor that determines the results. The target, then, are the minds of the population, the entire population: Our troops, the enemy troops, and the civil population.



Psychological Warfare

Psychological Operations or PSYOP are planned operations to convey selected information and indicators to audiences to influence their emotions, motives, objective reasoning, and ultimately the behavior of organizations, groups, and individuals. Used in all aspects of war, it is a weapon whose effectiveness is limited only by the ingenuity of the commander using it.

A proven winner in combat and peacetime, PSYOP is one of the oldest weapons in the arsenal of man. It is an important force protector/combat multiplier and a non-lethal weapons system.

Psychological Operations (PSYOP) or Psychological Warfare (PSYWAR) is simply learning everything about your target enemy, their beliefs, likes, dislikes, strengths, weaknesses, and vulnerabilities. Once you know what motivates your target, you are ready to begin psychological operations.

Psychological operations may be defined broadly as the planned use of communications to influence human attitudes and behavior ... to create in target groups behavior, emotions, and attitudes that support the attainment of national objectives. The form of communication can be as simple as spreading information covertly by word of mouth or through any means of multimedia.

A psychological warfare campaign is a war of the mind. Your primary weapons are sight and sound. PSYOP can be disseminated by face-to-face communication, audio visual means (television), audio media (radio or loudspeaker), visual media (leaflets, newspapers, books, magazines and/or posters), online memes. The weapon is not how its sent, but the message it carries and how that message affects the recipient.



It has long been said that: "The pen is mightier than the sword".

That is because, if used properly, words can be an inspiration to motivate others. Some examples:

"Give me liberty or give me death"

"I regret I have but one life to give for my country"

"Ask not what your country can do for you? Ask what you can do for your country"

"We must secure the existence of our people and a future for white children"

Now for psychological operations to be effective, you must carefully plan your propaganda. You must make sure that you know everything about your enemy and that you are targeting his beliefs and not using your own.

How do you get to know your enemy? Intelligence reports, Area studies, in country research, defectors, native help, and even the enemy prisoners of war all are sources of information. As leaflets were developed during Desert Storm, they were tested on cooperative EPWs (enemy prisoners of war). Some of the recommendations for changes to the leaflet's illustrations made by these EPWs were: remove any trace of the color red (a danger signal to Iraqis), show Allied soldiers with chin beards rather than clean-shaven faces (beards convey trust and brotherhood in Iraqi culture), and add bananas to a bowl of fruit shown being offered to surrendering Iraqis (bananas are a great delicacy in Iraq). Also, an illustration depicting a surrendering Iraqi thinking of his family back home confused the EPWs. "Thought bubbles" are well-known in Western culture, but virtually unknown to Iraqis. The illustration was dropped.



In a memo written to then-Secretary of State John Foster Dulles on 24 October 1953, former U.S. President Dwight D. Eisenhower defined psychological warfare as anything "from the singing of a beautiful anthem up to the most extraordinary kind of physical sabotage."



Used during peacetime, contingencies and declared war, these activities are not a form of force, but are force multipliers that use nonviolent means in often violent environments. Persuading rather than compelling physically, they rely on logic, fear, desire or other mental factors to promote specific emotions, attitudes or behaviors.

Adolf Hitler rose to power by exploiting the dissatisfaction of supporters of the traditional left and right wing parties, by dwelling on the failure of these parties to solve the problems created by the conditions imposed on Germany

under the Treaty of Versailles. He then presented National Socialism as the one movement capable of uniting conservative nationalists with international socialists, the professional classes with the working classes in the service of the nation. The speeches he delivered urged national pride and unity and rightfully placed the blame for all of Germany's problems on others. His oratory techniques and use of propaganda gave him a truly hypnotic grip over the German masses. After taking over as leader, the Germans continued to use propaganda both to unite Germany and to intimidate their enemies. Radio broadcasts became a major means of passing propaganda to the enemy. Japan used the notorious "Tokyo Rose" to broadcast music, propaganda, and words of discouragement to allied forces. The Germans used Mildred Gillar, better remembered as "Axis Sally".

In order to obtain the maximum results from psychological operations in guerrilla warfare, each combatant must be highly motivated to engage in propaganda face to face, to the same degree that he is motivated to fight. This means that the guerrilla's individual political awareness, the reason for his struggle, must be as acute as his capacity to fight.

Such a degree of political awareness and motivation is obtained through group dynamics and self-criticism as a standard teaching method for guerrilla training and operations. Group discussions increase the spirit and the unity of thought of the guerrilla squadrons, and they exert social pressure on the weaker members to perform a better role in future training or in combat actions. Self-criticism is made in terms of one's own contribution or failures in one's contribution to the cause, the movement, the struggle, etc., and this introduces an element of positive individual commitment to the mission of the group.

The desired result is a guerrilla soldier who may justify his actions persuasively when he is in contact with any member of the People, and especially to himself and his guerrilla companions when enduring the vicissitudes of guerrilla warfare. This means that each guerrilla will be persuasive in face-to-face communication--propagandist, combatant---in his contact with the people; he must be capable of giving 5 or 10 logical reasons why, for example, a peasant must give him fabric, needle and thread to mend his clothes. When the guerrilla behaves this way, enemy propaganda will never turn him into an enemy in the eyes of the population. It also means that hunger, cold, fatigue and insecurity will have a meaning, psychologically, in the struggle for the cause, because of constant orientation.

9. Armed Propaganda

In the words of a leader of the HUK guerrilla movement, in the Philippines: "The population is always impressed by arms, but not because of the fear that they cause, but rather because they give a feeling of strength. We must present ourselves before the people, supporting them with our arms, and this will give them the message of the struggle."

This is, in a few words, the essence of armed propaganda.

Armed propaganda includes every action performed, and the good

impression which this armed force may give will result in the population having a positive attitude towards those forces; it does not include forced indoctrination. Armed propaganda improves the behavior of the population towards its author, and it is not achieved by force. This means that an armed guerrilla unit in a rural town will not give the impression that its weapons are a force that they hold over the peasants, but rather that they are the strength of the peasants against the repressive zionist government. This is achieved through a close identification with the population, as follows: hanging up the weapons and working alongside them in their fields, in construction, harvesting the grain, fishing, etc.; giving explanations to young men about basic weapons, for example, giving them an unloaded weapon and allowing them to touch it, see it, etc., giving a basic description of its operation; describing, with simple slogans, how the weapons will serve the people in winning their freedom; adopting the demands of the people for hospitals and education, a reduction of taxes, etc. The objective of all these actions is to create an identification of the people with the weapons and with the guerrillas who carry them, so that the population feels that those weapons are, indirectly, the weapons that will protect them and help them in their struggle against an oppressive regime. There is always implicit terror in weapons, since the people are internally "aware" that they could be used against them; however, as long as explicit coercion can be avoided, we may achieve positive attitudes about the presence of armed guerrillas in the midst of the population.

10. Development and Control of 'Front' Organizations

The development and control of 'front' organizations is carried out through internal subjective (concealed) control, through group meetings of the 'internal cadres,' and by calculating the time needed for the combination of these two elements to be applied to the masses.

Established citizens--doctors, attorneys, businessmen, teachers, etc.--will be recruited initially as "Social Crusaders" in typically "innocuous" movements in the area of operations. When their 'involvement' with the clandestine organization is revealed to them, this exerts psychological pressure on them so that they can be used as "internal cadres" in groups to which they already belong or groups which they could join. Then, through a gradual and skillful process, they will receive instruction in persuasion techniques for the control of target groups which will support our revolution. A system for the control of cells isolates individuals from one another, and at the appropriate moment, their influence is used to fuse the groups together into a united national front.

11. Initial Recruitment

The initial recruitment to the movement if involuntary will be carried out by means of several "private" consultations with a cadre (without the recruit realizing that he is speaking to one of our members). Afterwards, the recruit will be informed that he or she is already in the movement, and will be running the

risk of the government police if he or she does not cooperate.

When the guerrillas carry out missions of armed propaganda and a program of regular visits to the towns by Armed Propaganda Teams, these contacts will provide to the commanders the names and places of persons that can be recruited. Voluntary recruitment is effected by means of visits from guerrilla leaders or political cadres.

After a chain of voluntary recruitments has been developed, and their reliability has been established by completing some minor missions, they will be instructed on widening the chain by recruiting in specific target groups, according to the following procedure:

- From among their acquaintances or through observation of the target groups—political parties, labor unions, youth groups, farming organizations, etc.—find out the personal habits, preferences and aversions, as well as the weaknesses, of the recruitable individuals.

- Make an approach through an acquaintance, and if possible, develop a friendship, attracting (the individual) by means of his preferences or weaknesses; possibly by inviting him to lunch in a restaurant he likes, or to have a drink in his favorite bar, or an invitation to dinner in a place he prefers.

Recruitment should follow one of the following patterns:

- If in an informal conversation the target seems susceptible to voluntary recruitment based on his beliefs and personal values, etc., the political cadre assigned to carry out recruitments will be notified. The original contact will indicate to the assigned cadre in detail all that he knows about the possible recruit, and the style of persuasion that should be used, and introduce the two.

- If the target does not seem susceptible to voluntary recruitment, meetings which will seem accidental can be arranged with guerrilla leaders or political cadre (unknown to the target until then). The meeting will be done so that "other persons" know that the target was there, because they saw him arrive at a certain house, or seated at a table in a certain bar, or even seated on a park bench. The target is then confronted with the fact of his participation in the insurrection and he will also be told that if he fails to cooperate or to carry out future orders, he will expose himself to reprisals on the part of the regime's police or military.

- Notification of the police, informing on a target who refuses to join the guerrillas, can be easily carried out, when it is necessary, by means of a letter with false declarations by citizens who are not implicated in the movement. Care must be taken so that the person who recruited him covertly should not be uncovered.

- With the completion of clandestine missions for the movement, the involvement and commitment of each recruit will gradually become greater, and his confidence will increase. This should be a gradual process, in order to prevent confessions from frightened individuals to whom very difficult or dangerous missions have been assigned too early. Using this recruiting technique, our guerrilla can successfully infiltrate any key target group in the regime, in order to improve internal control over the enemy structure.

Established citizens, Subjective Control

Established citizens - such as doctors, lawyers, businessmen, landowners, minor state officials, etc. - will be recruited into the movement and used for the subjective internal control of groups and associations to which they belong or may belong. Once the recruitment/involvement has been accomplished, and has progressed to a point of reliability which permits specific instructions to be given to the cadre in order to begin to influence their groups, directions will be given to them to carry out the following:

- The procedure is simple and requires only a basic knowledge of Socratic dialectics: that is the knowledge which is inherent to another person or to the established position of a group; some topic, come word or thought related to the goal 'of persuasion of our person in charge of recruitment.

- The member then should introduce this topic, work or thought into the discussions or meetings of the target group, by means of a casual remark, which will improve the focus of other group members in relation to it (the topic, etc.).

Specific examples are:

- Groups of economic interests are motivated by profit, and generally feel that the system prevents the use of their abilities in this effort in some way, taxes, import/export tariffs, transportation costs, etc. The cadre in charge (of recruitment) will make this feeling of frustration increase in later conversations.

- Political aspirants, especially if they are not successful, feel that the system discriminates against them unjustly by limiting their capabilities, because the zionist regime rigs elections in favour of special interests. The cadre should channel political discussions towards this frustration.

- Social-intellectual critics (such as professors, teachers, priests, missionaries, etc.) generally feel that the government ignores their valid criticisms and unjustly censors their commentaries. especially in a revolutionary situation. This can be easily demonstrated by the guerrilla member as an injustice of the system, in meetings and discussions.

- In all of the target groups, after the frustrations have been established, the hostility towards the obstacles to their aspirations will gradually be transferred toward the present regime and its system of repression.

The guerrilla cadre working among the target groups should always maintain a low-key presence, so that the development of hostile feelings towards the zionist regime will seem to come spontaneously from the group's members, and not from the cadre's suggestions. This is subjective internal control. The anti-government hostility should be generalized and not necessarily in our favour. If a group develops a favorable feeling towards us it can be used. But the main goal is to prearrange the target groups to be included latter in the mass organizations for the Operation when some other activities have been developed successfully.

12. Organization of Cells for Security

Internal cadres of our movement should be organized into cells of three persons, with only one of them having contact outside of the cell.

The three-man cell is the basic element of the movement; it has frequent meetings in order to receive orders and pass on information to the cell leader. These meetings are also very important for the cell members' encouragement of each other as well as for their morale. They should carry out self-criticism on the successes and failures in completing individual missions of subjective control.

Coordination of the three-member cell provides a secure network for two-way communication, each member having contact with only one operational cell. Members shall not reveal in cell coordination meetings the identity of their contact in an Operational cell; they shall divulge only the nature of the activity in which the cell is involved, e.g., political party work, medical association work. There is no hierarchy of cells beyond an element of coordination with the Zone Commanders through whom direct, but secret, contact will be maintained with the commander of our guerrilla group in the operational area or zone. For every three Operational cells we need a coordination cell.

Incorporation into a 'Front' Organization

The merging of organizations recognized by the zionist government, such as associations and other groups, through internal subjective control occurs in the final stages of the operation, in close relationship with mass meetings.

When armed guerrilla action has spread sufficiently, large-scale armed propaganda missions will be conducted: propaganda teams will have clearly expressed open support for the institutions; the enemy system of target groups will be well infiltrated; and the preparation of these groups when mass meetings are held. Then internal cadres will have to start discussions toward the merging of forces into an organization--this organization shall be a front "facade" group of our movement.

Any other target group will be aware that other groups are evincing a greater hostility toward the government, the police, and the traditional legal bases of authority. The guerrilla cadres in that group, such as teachers, will cultivate this awareness by making comments like 'so and so, who is a farmer, said that members of his cooperative believe that the new economic policy is absurd, poorly planned and unfair to the farmers.

When awareness that other groups are hostile to the regime is increased, group discussions are held openly and our movement will be able to receive reports that most of its operations are equally shared. There will develop greater hostility toward the regime and the order to merge will come forth.

The incorporation into a "facade" organization is undertaken as follows:

- Internal (cadres) from our movement will meet with others in positions of leadership, such as presidents, leaders, and others, in organized meetings presided by the organization's chief of our movement. Two or three escorts may assist the guerrilla cadre if it becomes necessary.

- Following the meeting a joint communique is to be issued, announcing the creation of the 'facade' organization, including names and signatures of participants and names of the organizations they represent.

- Following the issuance of this communique, mass meetings should be initiated, whose aim must be the destruction of the Zionist control system.

Infiltration of Guerrilla Cadres

Infiltration of guerrilla cadres (either a member of our own movement or an outside member) in trade unions, youth movements, peasant organizations, etc., preconditioning these groups to act among the masses, where they will have to proselytize in a clandestine fashion for the insurrectional struggle.

- Our psychological war team must develop in advance a hostile mental attitude among the target groups, so that at the given moment they can turn their anger into violence, demanding their rights taken away by the regime.

- These preconditioning-campaigns will be aimed at the political parties, professional organizations, students, workers, the unemployed masses, and at any other vulnerable or recruitable sector of society; this also includes the popular masses and sympathizers to our movement.

- The principal objective of a preconditioning campaign is to create a negative 'image' of the common enemy, for example:

- To describe managers of international mega-corporations as 'slave drivers' in their treatment of the personnel.

- To say that the police mistreat the people the same as the soviet union did

- To say that the officials of the government are lackeys of the Capitalist-Marxist combine.

Our psychological warfare cadres will create temporary compulsive obsessions in mass concentrations or group meetings by hammering on specific or selective topics; in informal conversations by expressing discontent; writing editorials for newspapers and radio, aimed at conditioning the people's thinking for the decisive moment, at which time they will turn to general violence.

- To facilitate the preconditioning of the masses we must repeat phrases frequently to let the people know, for instance, that

- The taxes they pay to the government do not benefit the people at all, and that, on the contrary, they are used in the form of exploitation and to enrich government officials.

- Make evident to them that the people have been turned into slaves, and are being exploited by privileged political and military groups.

- That foreign advisors and their advisory programs are in actuality 'interventionists' in our country, that they direct the exploitation of the nation in accordance with the objectives of the Global capitalists and marxists so as to turn our people into slaves of the hammer and sickle or the banking clans' greedy machine.

Control of Meetings and Mass Assemblies

The control of mass meetings in support of guerrilla warfare is carried out internally through a covert commando element, bodyguards, messengers, shock troops (incident initiators), poster carriers (also used to give signals), and slogan shouters, all under the control of the external commando element.

Support from Contacts Who are Rooted in Reality

The support of local contacts who know reality down to its roots is achieved through the exploitation of the social and political weaknesses of the target society, with propagandist-combatant guerrillas, armed propaganda, armed propaganda teams, front organizations and mass meetings.

The propagandist-combatant guerrilla is the result of a constant program of indoctrination and motivation. They will have the mission of demonstrating to the people the greatness and the justice of our movement, to all Citizens and to the world. By identifying with our people, sympathy towards our movement will increase, which will result in greater support from the population towards the freedom commandos, taking away sympathy from the regime in power.

Armed propaganda will extend this process of identification with the Nat Soc guerrillas, providing [an awareness of] common traits against the zionist regime. The Armed Propaganda Teams provide a stage-by-stage persuasive planning program in all areas of the country. These teams are also the 'eyes and ears' of our movement.

The development and control of front organizations in guerrilla warfare will give our movement the ability to create the effect of a 'whip' within the population, when the order to merge is given. When infiltration and subjective internal control have developed parallel to other guerrilla activities, one of our commanders will be able to literally shake down the zionist structure and replace it.

The meetings and mass assemblies are the culmination of a broad base of support among the population, and they occur in the later phases of the operation. This is the moment in which an overthrow may be achieved and our revolution can come out in the open, requiring the close collaboration of the entire population of the country, and requiring contacts who are rooted in reality. Tactical effort in guerrilla warfare is directed at the enemy's weaknesses, and toward destroying their military capability to resist, and must go parallel with a psychological effort to weaken and destroy their sociopolitical capability at the same time. In guerrilla warfare, more than in any other type of military effort, psychological activities must take place simultaneously with military activities, in order to achieve the desired objectives.

Interaction with the People

To ensure popular support, which is essential to the good development of guerrilla warfare, the leaders must lead to positive interaction between civilians and guerrillas, by the principle of "live, eat and work with the people," and they should

maintain control of this activity. In group discussions, the leaders and political cadres must emphasize a positive identification with the people. Talking about tactical military plans in discussions with civilians is not recommended. The communist enemy must be identified as the number one enemy of the people, and as a secondary threat against our guerrilla forces. As long as there is an opportunity, we must choose groups of elements who have a high degree of political awareness and high discipline in the work to be performed, to be sent to populated areas in order to conduct the armed propaganda.

They must persuade people through dialogue in face-to-face encounters, following these principles:

- Respect of basic non-marxist rights and respect of other's property
- Helping people in community work
- Protecting people from communist aggression
- Teaching about the environment and National Socialist values

These activities will arouse the peasant's sympathy towards our movement, and he will immediately become one of ours, through logistical support, cover and intelligence information about the enemy, or participation in combat. Guerrillas must be persuasive through the word and not overbearing through their weapons. When they behave this way, the people will feel that they are respected, and will be more inclined to accept our message, thus consolidating popular support.

13. Persuasion in Chats or Speeches

- Be simple and concise. Avoid the use of difficult words or expressions. Prefer popular words and expressions, that is, the language of the people. In dealing with a person, make use of concise language, avoiding complicated verbiage. It should be recalled that we use oratory to make our people understand the reason for our struggle and not to show our knowledge.

- Use vivid and realistic examples. Avoid abstract concepts, such as those used in universities in the higher years; instead of them, give concrete examples such as children playing, horses galloping, birds in flight, etc.

- Use gestures to communicate. In addition to verbal communication, we can communicate through gestures, such as moving our hands expressively, movements of the back, facial expressions, focusing our glance, and other aspects of "body language", projecting the individual personality in the message.

- Use the appropriate tone of voice. If in addressing the people one speaks about happiness, one will have to use a happy tone. If one speaks of something sad, the tone of voice must be of sadness; in speaking of a heroic act or act of valor, one will speak with an animated voice, etc.

- Above all, be natural. One must avoid imitating others, since people, especially simple people, can easily detect a charlatan. One will have to project one's individual personality when addressing the population.

Psychological Tactics, Maximum Flexibility

Psychological tactics will have the maximum flexibility within a general plan, permitting a continuous and immediate adjustment of the message, and making sure to create an impact on the indicated target group, at the moment at which it is most susceptible.

Tactically, a program of Armed Propaganda Teams should cover the greater part, and if possible all, of the operational territory. The communities in which the propaganda will be conducted will not necessarily have to coincide with political units of an official character. A complete understanding of their structure or organization is not necessary, because the cadres will Operate by applying social-political action and not academic theory.

The target populations of the Armed Propaganda Teams will be selected because they are part of the operational area, and not because of their size or the extent of their territory.

- The objective will have to be the people, not the territorial area.
- In this respect, each work team will have to cover approximately six population centers, for the purpose of developing popular support for our movement.

- The team will always have to move in a covert manner within the population centers of its area. It will have to vary its route radically, but not its itinerary. This is so that the inhabitants who are cooperating may depend on its itinerary, that is, on the time at which they may frequently contact it to give it information.

- The danger of betrayal or ambush can be neutralized by varying the itinerary slightly, using different routes, as well as by arriving or leaving without advance notice. While the surprise factor is used, vigilance will have to be exercised in order to detect the possible presence of hostile elements.

One should not stay more than three consecutive days in one populated place. The three-day limit has obvious tactical advantages, but it also creates a psychological effect on the people when they see the team as a source of current and up-to-date information. Also, it may overexpose the target audience and cause a negative reaction.

Basic tactical precautions will have to be taken. This is necessary for greater effectiveness, as was indicated in the discussion of the topic of "Armed Propaganda" When it is conducted in a discreet manner, it increases the respect of the population for the team and enhances its credibility.

In their free time, our guerrillas should mingle with the community groups and participate with them in community activities, fiestas, birthdays, and even in wakes or burials of members of the community. They will try to talk with both adults and adolescents. They will try to penetrate within the family, in order to gain the acceptance and trust of all the residents of the sector.

The cadres of the Armed Propaganda Teams will give ideological training, mixing these

instructions with folk songs, and at the same time telling stories which have some attraction, trying to have them allude to heroic acts of our ancestors. They will also try to tell of the acts of heroism of our fighters in the present struggle, so that the listeners may try to imitate them. It is important to let them know that there were Fascist and National Socialist governments with rulers who concern themselves with the welfare of their people, in order that the children have medical attention and free education; where they also concern themselves with seeing that everyone has job and food and all freedoms, such as those of religion, association, and expression; where the greatest objective of the government is to keep its people happy.

The cadres should mention their political ideology during the first phase of identifying with the people and talks should be oriented towards subjects which are pleasant for the peasants or those who are listening trying to be as plain as possible to be well understood.

The tactical objectives for identification with the people are the following:

- Establishing close relations through an identification with the people, by means of the same customs.
- Determining the basic needs and desires of the different target groups.
- Discovering the weaknesses of the government control.
- Little by little, sowing the seed of Nat Soc revolution, in order to change the vices of the regime towards a new order of justice and collective well-being.

In the motivation of the target groups by the Armed Propaganda Teams, the cadre must apply themes of "true" and "false" groups. The true group will be the target group and the false will be the zionist regime.

For the economic interest groups, such as small businessmen and farmers, we must emphasize that their potential advantages are "limited" by the zionist government, that the "resources are-increasingly scarce, profits are minimum, taxes high, etc. This may be applied to transportation entrepreneurs and others.

For elements ambitious for power and social position, we will emphasize that they will never be able to belong to the government social class, since their circles of power are hermetically closed. For example, the zionist leaders do not allow other people to participate in the government, and they impede the development of the economic and social potential of those who, like them, have the desire to better themselves, which is unfair and arbitrary.

Social and intellectual criticism. They must be channelled towards the professionals, professors, teachers, priests, missionaries, students and others. They must see that their writings, comments or conversations are censored, which does not allow a corrections of these problems.

Once the needs and frustrations of the target groups have been determined, the hostility of the people toward the 'false' groups will become more direct against the present regime and its repressive system. The people will be made to see that once this system or

structure is eliminated, the cause of their frustrations would be eliminated and they could make their wishes come true. It must become evident for the population that supporting the insurrection is really supporting their own desires, since the National Socialist movement is aimed at the elimination of these specific problems.

As a general rule, the Armed Propaganda Teams should avoid participating in combat. However, if this is not possible, they must react as a guerrilla unit with 'hit—and-run' activities, inflicting the greatest amount of casualties on the enemy with aggressive assault fire, recovering enemy weapons and withdrawing quickly.

An exception to the rule of avoiding combat shall be when they are challenged in the town by hostile actions, be it by an individual or by an equal number of men from the enemy side.

Hostility from one or two men can be dominated eliminating the enemy in a quick and efficient manner. This is the most common danger.

When the enemy is equal in numbers, they must withdraw immediately, and later ambush them, or eliminate them by means of sharpshooters.

In any case, the cadres from the Armed Propaganda Teams must not turn the town into a battlefield. Usually, our guerrillas will be better armed, for which reason they will obtain greater respect from the population if they carry out opportune maneuvers instead of putting their lives in anger, or even destroying their homes in an encounter with the enemy inside the town.

MASSIVE GRASS-ROOTS SUPPORT THROUGH PSYCHOLOGICAL OPERATIONS

General Information

Covering these sections separately could leave the student with some doubts. Therefore, all sections are herewith summarized, in order to give a clearer picture of the topic.

Motivation as a Propagandist—Combatant

Each member of the struggle should know that his political mission is as important as, if not more important than, his tactical mission.

Armed Propaganda

Armed propaganda in small towns, rural villages, or city districts should give the impression that our weapons are not to exercise power over the people, but that weapons are for the protection of the people; that they are the power of the people against the government of oppression.

Armed Propaganda Teams

The Armed Propaganda Teams will combine political awareness with the capacity for effecting propaganda for personal persuasion, which will be carried out within the populated area.

'Cover' Organizations

The merger of various organizations and associations recognized by the government occurs by means of internal subjective control in the final stages of the operation, in close cooperation with the mass meetings.

Control of Mass Demonstrations

Mixing members of the struggle with participants in the demonstration will give the appearance of a spontaneous, undirected manifestation, which will be used by the agitators of the struggle in order to control the behavior of the masses.

Conclusion

Too frequently we view guerrilla war only from the point of combat actions. This evaluation is erroneous and extremely dangerous. Combat actions are not the key to triumph in guerrilla warfare, but a part of one of the six basic efforts.

None of these efforts bears a priority; rather, they should progress in a parallel fashion. Emphasizing or excluding any of these efforts could bring about serious DIFFICULTIES—difficulties and, at worse, even failure. THE HISTORY OF REVOLUTIONARY WARS HAS DEMONSTRATED THIS TRUTH.

14. Oratory Basics

1) The Audience

Oratory is the coincidental means of communication par excellence; that is, the speaker and his audience coincide in a single time and place. For that reason, each speech should be a different experience, framed in 'that' circumstance or actual situation in which the audience is living and is influenced.

So that audience should be considered as a 'state of mind':

Happiness, sadness, anger, fear, etc., are psychic states that we should consider to exist in our audience, and it is the environment that affects the target public. The human being consists of a mind and a soul; he acts in accordance with thoughts and feelings, and responds to the stimuli of ideas and emotions.

Therefore, there are only two possible approaches to any exposition, including speeches: a real approach, based on appeals to reason, that is, to thought; and an idealized approach, which appeals to the emotions, or to the Sentiments.

As far as the speaker is concerned, even though he should be sensitive to the existing collective emotions, at the same time he should set himself apart in order to be able to effectively lead and control the emotions of the audience. When during the oratorical momentum the antithesis between heart and mind is produced, judgment, the characteristic of a leader, must always prevail.

2) Political Oratory

Political oratory is one of various forms of public speaking and usually accomplishes one of the following three objectives: it teaches, persuades or moves the audience; the method used boils down to appeals, commands, questions and answers.

Oratory is a quality so tied to political leadership that it can be said that the history of political speakers is the political history of humanity, a statement upheld by names such as Cicero, Demosthenes, Dante, Mirabeau, Robespierre, Clemenceau, Lenin, Trotsky, Mussolini, Hitler, Roosevelt, etc.

3) Positive Aspects of a Speech

In general the features most valued in a speech, and specifically in a political speech within the framework of psychological action in the armed struggle, are the following:

Brevity and succinctness: a five minute speech is ideal. A speaker who is brief demonstrates even more his ability as stated in that well-known expression: 'if they want a two hour speech, I'll begin now; if they want one that lasts only two minutes, let me think awhile.'

Development around a theme: a speech must be a group of organized ideas which develop around a subject. A good speech is expressed in concepts and not only with words.

Logic: the ideas presented must be logical and easily acceptable. Never should the logic in the minds of the audience be challenged, since this would lead immediately to a loss of what is most important: namely credibility. When possible it is advisable to base a speech on a syllogism which the speaker should adapt to his exposition. For example: "Those who enrich themselves while governing are thieves; the Capitalist jews have become rich while governing; therefore, the Capitalists are thieves." This could be the message of a speech on the administrative corruption of the regime. Whenever a speech lacks an idea or a group of directing ideas, it can easily become dispersed and confusing.

4) Parts of a Speech

There is no true improvisation in oratory. Every speaker uses a "mental plan" which permits him to organize his ideas and concepts quickly. With practice it is possible to do this in only a few seconds, almost simultaneously with speaking.

The elements which constitute a speech appear below in the order recommended to those who wish to consistently improve their Speaking ability:

Introduction or exordium: Upon initial contact with the audience, a personal introduction can be made or one for the group to which we belong as well as the reason for our presence there, etc. During these first seconds it is important

to make an impact, calling for the attention and arousing the audience's interest. For that there are resources like starting with key quotations or slogans previously arranged to tell a dramatic or humorous anecdote, etc. Proposal or statement: the subject of the speech is defined, either by explaining it as a whole or in parts.

Assessment or argument: arguments are presented in exactly this order: first the negative arguments, or those which oppose the thesis which is to be upheld, and then the positive arguments, or those favorable to our thesis, immediately adding proofs or facts which support these arguments. Summing up or conclusion: a brief summary should be made and the conclusions should be made more explicit.

Exhortation: an appeal for public action is made, in other words, the audience is encouraged almost always energetically to do or not to do something.

5) Some Literary Resources

Although there are typically oratorical figures of speech, truly, oratory has borrowed a large number of figures from other literary genres, several of which we use, often unconsciously, in our daily expressions and even in our speech.

Below we list a good number of literary figures which are frequently used in oratory, recommending to those interested that they use them in moderation, since an orator who makes excessive use of literary figures loses authenticity and sounds false.

The figures that are most often used in oratory are those obtained through the repetition of words at certain points of the speech, such as:

- Anaphora or repetition of a word at the beginning of each phrase; for example: 'Freedom for the poor, freedom for the rich, freedom for all.' In reiteration, a complete phrase (slogan) is repeated insistently throughout the speech: for example: "With God and patriotism we will defeat communism, because. . .'

- Conversion is repetition at the end of each phrase. For example: "'The marxist [movement] pretends to be above everyone, dominate everyone, lord over everyone, and as an absolute tyranny, eliminate everyone."

- Complexity: repetition takes place at the beginning and at the end of the clauses. Example: "Who brought about the Soviet Union? The jews. And who trades in arms with the neighboring countries? The jews. And who proclaims now to be a supporter of non-intervention? The jews.'

- Reduplication, when the phrase begins with the same word that ends the previous phrase. Example: "We fight for Folk, Folk and Nation." Linking is a chain formed by several duplications. Example: "Communism transmits the deception from the child to the youth, from the youth to the adult, and from the adult to the elderly."

- In the play on words one uses the same words with a different meaning to obtain a clever effect. Example: "The greatest wealth of each human being is his

own freedom, because slaves will always be poor, but we the poor can have the wealth of our freedom.“

- Similar rhythm, by using verbs of the same tense and person, or nouns of the same number and case. Example: "We who are fighting will enter marching because who perseveres reaches and who gives up falls behind“

- Synonymity, the repetition of words of similar meaning. Example: "We demand a Nation for all without exceptions without omissions.“

Among the most commonly used background figures of speech

- Comparison or simile which determines the resemblance relation between two or more beings or things. Example: Because we love Christ we love his bishops and ministers." "Free as a bird“

- Antithesis, is the contrast of words, ideas or phrases of Opposite meaning. Example: "They promised freedom and gave Slavery; that they would distribute wealth and distributed poverty: that they would bring peace and brought about war."

Among the logical figures are the following:

- Concession which is a clever way of conceding something to the opponent in order to better emphasize the difficulties by using conjunctions such as: but, however, although, nevertheless, in spite of, etc. Example: "The mayor has been honest here, but he is not the one who handles all the monies of the nation." This is an effective way of rebutting when the opinion of the audience is not completely on our side.

- Permission, when apparently one agrees to something but in reality rejects it. Example: "Do not protest but subvert." "Speak low but tell everyone (rumor)."

- Prolepsis is a refutation in advance. Example: "Some will think it is only promises; they will say just like the others said it, but it is not so. We are different, we are Christians, we consider God witness of our words."

- Preterition consists of a ruse which by feigning discretion, something very clear and indiscrete is said. Example: "If I were not obligated to safeguard military secrets, I would tell all of you about the great quantity of armaments in our possession, so that you may have greater confidence in the certainty of our victory."

- The communication is a way of asking and answering a question oneself. Example: "If they have disrespect for God's ministers, will they respect us, simple citizens that we are? Never."

- Doubt is a way to express perplexity or helplessness in saying something, used solely as an oratorical aid. Example: "I am only a peasant and can tell you very little. I don't know very much and cannot explain the complex issues of politics. This is why I'm speaking to you from the heart, my simple heart of a peasant, which we all are."

- Litotes is a means of signifying much while saying very little. Example: "The zionist commanders haven't stolen much, only the whole country."

- Irony consists of meaning the exact opposite of what is being said.

Example: "The divine throngs who threaten and kill, those are really Christian."

- Amplification is presenting an idea from different angles. Example: "A benevolent government is the power of the people in National Socialism. Economic votes are their power in the economy. The majorities decide what is to be produced whether they buy or not. That is the way of economic liberty."

The pathetic figures most commonly used are:

- Prayer or supplication to obtain something. Example: "Lord, free us from the yoke, grant us freedom."

- The implication of threat, expressing a feeling against what is unjust or unsolvable. Example: "May there be a Fatherland for all, or for none at all"

- The threat, similar to the above, presents a feeling of ill-will towards others. Example: "May they sink into the chasm of their own corruption."

- The apostrophe, consists of addressing something extraterrestrial or inanimate as if it were a living being. Example: "Soil of our Nation, make the seed of liberty grow."

- Interrogation consists of questioning oneself for the sake of emphasis. It differs from the communication in that the latter gives an answer which is logical, not pathetic. Example: "If they have already killed my family, friends, my brother peasant, do I have another recourse but to take up arms?"

- Insinuation consists of intentionally presenting an incomplete thought to be completed mentally by the audience. Example: "They promised political pluralism and delivered tyranny; they promised social justice and they have increased poverty." "They offered press freedom and delivered censorship." "They promised the world a government which cares about the Folk....."

15. Creating a New Identity

The below method is slightly outdated and may not work. It could be useful to simply contact your local criminal organization for a forged ID or search the deep web for guides on how to create your own.

STEP 1: Death certificate

The first step is to find out who exactly you'll become. The most secure way is to use someone's ID who doesn't use it themselves.

The people who fit that bill the best are dead. Go to the library or online and look through old death notices. You have to find someone who was born about the same time as you were. You should go back as far as you can for the death because most states now cross index deaths to births so people can't do this in the future. Anything earlier there is cool. Now, this is the hardest part if you're younger. There aren't many that die. Go down to the library and look up all the death notices you can. You might have to go through months of death notices though, but the results are well worth it. You've got to get someone who died locally in most instances:

the death certificate is filed only in the county of death. Now you go down to the county courthouse in the county where he died and get the death certificate. Look at this hunk of paper, it could be your way to vanish in a cloud of smoke when the right time comes, like right after a big operation. If you're lucky, his parents signed him up with social security when he was a snot nosed brat. That'll be another piece of ID you can get. If not, that's ok too. It'll be listed on the death certificate if he has one. If you're lucky, he was born locally and you can get his birth certificate right away.

STEP 2: Birth certificate

Now check the place of birth on the death certificate, if it's in the same place you standing now you're all set. If not, you can mail away for one from that county but it's a minor pain and it might take a while to get, the librarian at the desk has listings of where to write for this stuff and exactly how much it costs. Get the Birth certificate, its worth the extra money to get it certified because that's the only way some people will accept it for ID. When your getting this stuff the little forms ask for the reason you want it, instead of writing in "Fuck you", try putting in the word "Geneology". They get this all the time. If the Death certificate looks good for you, wait a day or so before getting the certified birth certificate in case they recognize someone wanting it for a dead guy.

STEP 3: Getting an ID

You got your start and the next part's easy. Crank out your old printer and run off some mailing labels addressed to you at some phony address. Take the time to check your phony address that there is such a place. Hotels that rent by the month or large apartment buildings are good, be sure to get the right zip code for the area. These are things that the cops might notice that will trip you up. Grab some old junk mail and paste your new labels on them. Now take them along with the birth certificate down to the library. Get a new library card. If they ask you if you had one before say that you really aren't sure because your family moved around a lot when you were a kid. Most libraries will allow you to use letters as a form of ID when you get your card. If they want more give them a sob story about how you were mugged and got your wallet stolen with all your identification. Your card should be waiting for you in about two weeks. Most libraries ask for two forms of ID, one can be your trusty Birth Certificate, and they do allow letters addressed to you as a second form.

STEP 4: State ID card

Now you got a start, it isn't perfect yet, so let's continue. You should have two forms of ID now. Throw away the old letters, or better yet stuff them inside the wallet you intend to use with this stuff. Go to the county courthouse and show them what nice ID you got and get a state ID card. Now you got a picture ID.

STEP 5: Social Security number

If the death certificate had a social security number on it you can go out and buy one of those metal SS# cards that they sell. If it didn't, then you got all kinds of pretty ID that shows exactly who you are. If you don't yet have an SS#, Go down and apply for one, these are free but they could take five or six weeks to get, Bureaucrats you know... You can invent a SS# too if you like, but why not go the full length?

STEP 6: Bank Account

If you want to go the whole way you can now get a bank account in your new name. If you plan to do a lot of traveling then you can put a lot of money in the account and then say you lost the account book. After you get the new book you take out all the cash. They'll hit you with a slight charge and maybe tie-up your money some, but if you're ever broke in some small town that bank book will keep you from being thrown in jail as a vagrant. If you work, here's a way to stretch your money. Go to work for as long as it takes to get unemployment and then get yourself fired. Go to work under the other name while you're getting the unemployment.



IV. Equipment and Weapons

1. The Best-Case Scenario

“Personal weapons must be compact and robust, with a high rate of fire and very lightweight ammunition, but there is also a place for shotgun-like weapons at the squad level. Overall, soldier loads must be reduced dramatically at the edge of combat, since fighting in tall buildings requires agility that a soldier unbalanced by a heavy pack cannot attain; further, vertical fighting is utterly exhausting and requires specialized mobility tools. Soldiers will need more upper body strength and will generally need to be more fit-and this includes support soldiers, as well”

- *“Our Soldiers, Their Cities,”* Ralph Peters. Parameters, the official journal of the US Army War College.

If you have the luxury of extensive access to firearms and ammunition, then make good use of your situation by stockpiling ammunition and guns for your fellow bloodbrothers. The following recommendations are primarily for revolutionaries in the USA, though they mostly hold true internationally. It is also recommended to start accumulating and studying military manuals about weapons you may encounter in the field, i.e. Light Anti-tank Weapons, TOW and Stinger missiles, various machineguns.

Rifles

Probably the best single choice for the purpose described here would be an assault rifle chambered for the 7.62mm (.308 Winchester) cartridge. Scoped and in the hands of a skilled marksman, this cartridge is capable of hits on man-sized targets at 500+ yards. Even lead bullets in this caliber are powerful enough to penetrate most body armor, car bodies and the brick walls of homes. Good choices include the M1-A, the FN-FAL, the inexpensive CETME, and Heckler & Koch's HK-91.

Springfield Armory's M1-A is a pricey, yet incredible battle rifle. A folding stock will enhance its use in urban combat.

A good second choice is one of the 5.56mm (.223) rifles such as the Colt AR-15 or Ruger Mini-14. The 5.56mm cartridge is readily obtainable in quantity since it is a current U.S. military round. It offers excellent accuracy and reasonable stopping power out to 250 yards. Recoil is very mild.

32Colt's AR-15 carbine is an ideal weapon for urban combat.

The Ruger Mini-14 can be a good choice, inexpensive and available, but it has its problems. The factory barrel is too light and gets very hot after firing only two 20 round magazines. Heavier barrels are recommended as well as after-market stocks.

The Ruger Mini-14 is an affordable .223/5.56mm rifle.

Firing the 7.62x39mm round, the AK-47 is the standard by which all assault rifles are measured. Manufactured around the world, the Russian and

German models tend to be of the best quality. The downside is that the ammunition is not a U.S. government stock item. All ammunition must be provided by the users.

The AK-47 is an ideal weapon for urban fighting, small, lightweight, and powerful.

Shotguns

For gunfights at close range, such as inside buildings, nothing is as effective as the 12 gauge shotgun. 12-gauge “high brass” shells in 00 or number 4 buckshot will knock down even the largest adversaries. There are no reports of anyone ever taking a chest full of either size then getting back up.

Shotguns can also be made very small for use in clearing buildings.

Most shotguns are slow and clumsy to reload, so you should add an eight or ten-round magazine extension. Those made by Choate Machine & Tool Company are among the best. The 18 and 20-inch barrels are handy lengths for close quarter combat.

Handguns

The choice of pistols is strictly a personal matter since very few will use them as their primary weapon. Whether you like automatics or revolvers is not as important as is access to ammunition. The U.S. government used the .45 pistol for over fifty years and only recently switched to the 9mm. Ammunition for the Beretta will be more common on the battlefield, since today’s police departments have standardized their calibers with the military. Again, as a backup weapon the pistol can be in any caliber. If you are happy with your .357 magnum and can hit what you aim at, by all means use it.

The Colt .45 and the Beretta 9mm military issue pistols, both are good choices.

Grenades

The probability that purchasing hand grenades is legal in your country is very low. That being said, if you manage to acquire a vendor, legal or illegal, here are some you should consider:

- Eurometaal Nr20
- F1
- OD/82 HE/SE
- RGN
- M67
- HG 85
- Arges Type HG 84

Consult FM 3-23.30 by the Department of the Army for more information regarding grenades and their usage.

2. Gear and tools for Urban Guerrillas

Urban guerrillas will usually be more lightly armored than their rural counterparts. They may even wear civilian clothing with only a balaclava or arm binding to set them apart. Their gear and tools too are usually minimal: only what is necessary for the mission at hand. If it involves expropriation of assets, then lockpicking tools, crowbars, wire cutters and saws are needed. If it is a patrol or scouting mission then communication and photography equipment is useful. There is no standard gear or tool list for the urban guerrilla other than at least one loaded firearm.

Gear and tools for Rural Guerrillas

Every guerrilla needs:

Boots (two pair)
Socks (wool and cotton, six pair of each)
Gloves (leather with wool liners, two pair)
Underwear (several pair)
Combat fatigues (olive drab or woodland camouflage, four sets)
Waterproof poncho and liner
Field jacket and liner
Blanket or Sleeping bag suitable for weather conditions
Sleeping pad
Long underwear (two pair)
Kevlar Helmet or steel pot with liner
Beret or boonie hat
Camo gear (paint, veil, mask or burnt cork)
Pistol belt
Suspenders for pistol belt
Signal mirror
Radio (Two way and AM/FM) with extra batteries
Rope (25 feet)
Alice pack (medium or large)
Rifle or shotgun
Pistol
Holster
Rucksack or pack
Haversack or hunting pouch
Canvas piece
Tent or Shelter Half
Webbing or belt
Gas mask
Ammunition pouches (at least two)
Ammunition (minimum 1000 rounds per weapon)

Mess Kit
Two canteens with insulated covers
Canteen cup
Butterdish
Cutlery
Hunting knife or dagger
Compass
Lighter, matches, magnifying lens, firestone
Weapons cleaning kit
Sewing kit
Personal hygiene kit
Wash and cleaning kit
Pencil and paper
Watch
Camouflage net
Mosquito (head) net
Insect repellent
Water purification tablets
Toilet paper
Utility knife (Swiss army knife)
Combat knife

First-aid equipment:

Small first-aid kit with basic first-aid instructions
Bandage pack (on the body)
Quinine
Aspirin
Anti-biotics
Vitamin Drops
Tannalbin
Amphetamines
Water purification tablets

Each group needs:

Binoculars
Flashlights with extra batteries
Electrical tape (black)
Mapcase and maps
Calendar with rising and setting times of sun and moon
Edible plants and animal guide/survivalism guide
Shovel or entrenching tool
Claw axe
Saw
Insulated pliers and wire cutters

Collapsible stoves for solid fuel
Whistle

Food Rations

The best rations are military style MREs. They can be purchased by civilians from survival and prepping stores or created yourself. Generally you can expect: Salted MRE crackers, spicy MRE cheese spread, jam, Coffee instant type 1, early 90s orange drink base, cigarettes, vacuum sealed packaging/cans. Good MREs may include:

- Kielbasa
- Beans
- Sauerkraut
- Tomato sauce
- Big chunks of meat, no mechanically separated meat (pink goo)
- No dark meat chicken (doesn't taste good)
- Soupy consistence, so you can add rice / buckwheat / panzerwaffles for more calories and taste
- Panzerwaffles in general, especially SU-2
- Something bearable to wash it down with (kisiel, coffee, tea, anything instant would work)
- Candy bars. Specifically, cereal bars, nut bars, fruit bars, jelly bars. Something sweet and chewy, bonus points for fibrosity
- a small can of condensed milk and some biscuits

The bare basics for long term survival are: crackers, dried meat (Pemmican/Beef Jerky/Biltong) or legumes, water, candy bars (for instant energy), vitamin pills or vitamin-fortified louloumi.

Emergency Rations

A useful emergency food is wood flour. It is best obtained from young pines or birch stems in the following manner: Remove the upper bark layer; detach the moist, soft underlayer and cut it into small pieces; boil over several changes of water until the taste of the resin is sufficiently softened; dry thoroughly until the chips become tender and brittle; pound and grind. The obtained yellowish-brownish bark meal can either be added to the rye or wheat flour for stretching or can also be enjoyed unmixed. To do this, make a dough with water or milk, roll it out flat, cut it into small pancakes and then bake them on tin or iron pans. Very young spruce shoots can be eaten raw or cooked. Edible mushrooms are a good food, also berries. Mushrooms become poisonous by frost, while many berry species become edible and palatable only by frost, such as mountain ash, barberry, and the

like. Very nutritious and rich in vitamins are the bog cranberries, the buffalo cranberries, elderberries, rose hips. Linden buds and most lichens (with the exception of the yellowish-colored, in particular the well-known gray-white, reindeer moss) are edible. The bitter substances contained in lichens are removed by several hours of soaking in water to which wood ash has been added. Then they can be cooked to an edible pulp. In an emergency, you can eat lichen after a thorough rinse also raw. On the banks of rivers and lakes you can dig up the thick roots of calamari reeds, which can be eaten raw, or when cooked or baked they are quite edible.

Drones

Drones are an invaluable tool for modern guerrilla warfare. The Economist published the following article on the topic: <http://archive.is/XNJHy>. They are useful for intelligence gathering and offensive operations (or both when adjusting mortar shots). Jammers are the biggest threat to drone usage but you could aim a drone at a coordinate without the use of GPS if it contains an internal compass and some way to track distance. Drones also bypass modern radar: with the lack of metals, they do pretty well, mainly because there's nothing much to reflect. Russian VHF and UHF have a hard time tracking regular quadcopters in any significant range to be effective (around 7.7km with them knowing where to look).

Worse case they think it's a few birds, best case you have so much that you saturate their subsystems and they can't deal with it. Drones under \$25,000 use regular WIFI and a linux single board computer. Military and Commercial camera drones use all sorts of weird technology and frequencies.

Some guy at the defcon talks was able to jam the cheaper drones but the more expensive ones the best he could do was make them fly a bit irrationally. Regarding maximum range, You can get 40km of range with a \$70 radio link such as the TBS crossfire micro. Use of drones in creative mission such as assassination is highly recommended, though specifications and individual build guides fall outside of the scope of SS Paladin. Luckily research and methods are readily available online with minimal to no OPSEC risk since drones are a commercial product and drone building and design is a common hobby.

Camouflage

Camouflage in general is detailed very well in the SS Werewolf Combat Manual and elsewhere. Camouflage clothing patterns which are effective include:

- The Classic
- Valentino Sky blue camo
- Flecktarn

- Alpenflage
- Strichtarn
- DPM
- US M81 Woodland
- Finnish M05
- SchutzStaffel camo – for those who want the real original SS look
- Rhodie Brushstroke

Making camo clothing is simple. For a one off you could use watered down acrylic paint and paint it by hand. If you want to do a lot of fabric, screen printing is probably your best bet.

3. Unarmed Combat

This introduction will explain the basics of hand-to-hand combat, and will tell of the best places to strike and kill an enemy... When engaged in hand-to-hand combat, your life is always at stake. There is only one purpose in combat, and that is to kill your enemy. Never face an enemy with the idea of knocking him out. The chances are extremely good that he will kill YOU instead. When a weapon is not available, one must resort to the full use of his natural weapons. The natural weapons are:

- 1) The knife edge of your hands.
- 2) Fingers folded at the second joint or knuckle.
- 3) The protruding knuckle of your second finger.
- 4) The heel of your hand.
- 5) Your boot
- 6) Elbows
- 7) Knees
- 8) and Teeth.

Attacking is a primary factor. A fight was never won by defensive action. Attack with all of your strength. At any point or any situation, some vulnerable point on your enemies body will be open for attack. Do this while screaming as screaming has two purposes.

- 1) To frighten and confuse your enemy.
- 2) To allow you to take a deep breath which, in turn, will put more oxygen in your blood stream.

Your balance and balance of your enemy are two important factors; since, if you succeed in making your enemy lose his balance, the chances are nine to one that you can kill him in your next move. The best over-all stance is where your feet are spread about shoulders width apart, with your right foot about a foot ahead of the left. Both arms should be bent at the elbows parallel to each other. Stand on the balls of your feet and bend your waist slightly. Kinda of like a

boxer's crouch. Employing a sudden movement or a scream or yell can throw your enemy off-balance.

Tactics

Always try to throw your enemy off balance. You can do this by charging the enemy and pretending to strike him. This will make him flinch and lose his balance.

Always look for a weak spot and attack it. Whenever he leaves a vulnerable part of his body unprotected attack it with all your strength. By doing this, he will then try to protect the part of his body that you just struck thus leaving even more unprotected parts open.

Use any available object that you can. By this I mean throw sand in his eyes, block his strikes by hitting him with a large branch, or any other kind of available material that can be used as a weapon against him.

There are many vulnerable points of the body. We will cover them now:

Eyes: Use your fingers in a V-shape and attack in gouging motion.

Nose:(Extremely vulnerable) Strike with the knife edge of the hand along the bridge, which will cause breakage, sharp pain, temporary blindness, and if the blow is hard enough, death. Also, deliver a blow with the heel of your hand in an upward motion, this will shove the bone up into the brain causing death.

Adam's Apple: This spot is usually pretty well protected, but if you get the chance, strike hard with the knife edge of your hand. This should sever the wind-pipe, and then it's all over in a matter of minutes.

Temple: There is a large artery up here, and if you hit it hard enough, it will cause death. If you manage to knock your enemy down, kick him in the temple, and he'll never get up again.

Back of the Neck: A rabbit punch, or blow delivered to the base of the neck can easily break it, but to be safe, it is better to use the butt of a gun or some other heavy blunt object.

Upper lip: A large network of nerves are located. These nerves are extremely close to the skin. A sharp upward blow will cause extreme pain, and unconsciousness.

Ears: Coming up from behind an enemy and cupping the hands in a clapping motion over the victims ears can kill him immediately. The vibrations caused from the clapping motion will burst his eardrums, and cause internal bleeding in the brain.

Groin: A VERY vulnerable spot. If left open, get it with knee hard, and he'll buckle over very fast.

Kidneys: A large nerve that branches off to the spinal cord comes very close to the skin at the kidneys. A direct blow with the knife edge of your hand can cause death.

Advanced methods

COCCYX - A powerful blow to the tail bone. Fatal.

FULL NELSON - Stand behind the enemy, put your arms under his, and lock your hands behind his head. Bending the neck forward may either break neck, asphyxiate enemy, or cut off supply of spinal fluid to brain, causing brain damage or death.

HALF NELSON - Again, standing behind enemy, but one arm is used to pin one of enemy's arms.

BRAIN BUSTER - Bend enemy over towards you, placing him in a headlock. Grab the back of his belt, and haul him into the air, vertical, upside-down. Allow yourself to fall backward, landing on your enemy's head, which will absorb your combined weight. Most

effective on concrete or gravel.

RUSSIAN OMELET - Cross enemy's legs. Fold enemy by pinning his

shoulders to ground upside-down and placing his legs above him. Sit on his legs, folding the base of the spine. Fatal.

HEAD-TO-WALL PUNCH - A swift, hard, cold-cock punch to an enemy's face while he is standing near a wall may drive his head into it, causing the back of the skull to shatter fatally.

PINNED DROP KICK - Standing behind enemy, holding his arms straight back. A drop kick to the back without releasing arms may severe spine, causing death.

HEAD WRENCH - Grabbing an enemy's head by the mouth and the back of the skull, then twisting with a sudden, violent jerk to rend vertebrae, may easily cause death.

CHOKE HOLD - Once a favorite of law enforcement officials, has often proved deadly. The right arm goes over the enemy's right shoulder, and grips the back of the head. The left arm comes over his left shoulder, reaches across neck, and grabs own right forearm. With enough pressure applied, causes brain damage or death.

HEAD YANK - Bend enemy forward, grab head, and pull back with convincing force. May separate delicate vertebrae, causing death.

There are many more ways to kill and injure an enemy, but these should work best for the average person. Use these methods only, in your opinion, if your life is in danger. Any one of these methods could very easily kill or cause permanent damage to someone. One more word of caution, you should practice these moves before using them on a dummy, or a mock battle with a friend. (You don't have to actually hit him to practice, just work on accuracy.)



4. Assassination CLASSIFICATIONS

The techniques employed will vary according to whether the subject is unaware of his danger, aware but unguarded, or guarded. They will also be affected by whether or not the assassin is to be killed with the subject hereafter, assassinations in which the subject is unaware will be termed "simple"; those where the subject is aware but unguarded will be termed "chase"; those where the victim is guarded will be termed "guarded."

If the assassin is to die with the subject, the act will be called "lost." If the assassin is to escape, the adjective will be "safe." It should be noted that no compromises should exist here. The assassin must not fall alive into enemy hands. A further type division is caused by the need to conceal the fact that the subject was actually the victim of assassination, rather than an accident or natural causes. If such concealment is desirable the operation will be called "secret"; if concealment is immaterial, the act will be called "open"; while if the assassination requires publicity to be effective it will be termed "terroristic."

Following these definitions, the assassination of Julius Caesar was safe, simple, and terroristic, while that of Huey Long was lost, guarded and open. Obviously, successful secret assassinations are not recorded as assassination at all. Augustus Caesar may have been a victim of safe, guarded and secret assassination. Chase assassinations usually involve clandestine agents or members of criminal organizations.

THE ASSASSIN

In safe assassinations, the assassin needs the usual qualities of a clandestine agent. He should be determined, courageous, intelligent, resourceful, and physically active. If special equipment is to be used, such as firearms or drugs, it is clear that he must have outstanding skill with such equipment.

Except in terroristic assassinations, it is desirable that the assassin be transient in the area. He should have an absolute minimum of contact with the rest of the organization and his instructions should be given orally by one person only. His safe evacuation after the act is absolutely essential, but here again contact should be as limited as possible. It is preferable that the person issuing instructions also conduct any withdrawal or covering action which may be necessary.

In lost assassinations, the assassin must be a fanatic of some sort. Politics, religion, and revenge are about the only feasible motives. Since a fanatic is unstable psychologically, he must be handled with extreme care. He must not know the identities of the other members of the organization, for although it is intended that he die in the act, something may go wrong.

While the Assassin of Trotsky has never revealed any significant information, it was unsound to depend on this when the act was planned.

PLANNING

When the decision to assassinate has been reached, the tactics of the operation must be planned, based upon an estimate of the situation similar to that used in military operations. The preliminary estimate will reveal gaps in information and possibly indicate a need for special equipment which must be procured or constructed.

When all necessary data has been collected, an effective tactical plan can be prepared. All planning must be mental; no papers should ever contain evidence of the operation. In resistance situations, assassination may be used as a counter-reprisal. Since this requires advertising to be effective, the resistance organization must be in a position to warn high officials publicly that their lives will be the price of reprisal action against innocent people. Such a threat is of no value unless it can be carried out, so it may be necessary to plan the assassination of various responsible officers of the oppressive regime and hold such plans in readiness to be used only if provoked by excessive brutality. Such plans must be modified frequently to meet changes in the tactical situation.

Techniques

Manual, Accidents, Drugs, Edge Weapons, Firearms, Explosives. For more information see A Study of Assassination.txt hosted on:
http://cdn.preterhuman.net/texts/terrorism_and_pyrotechnics



Assassination using Bombs

When aiming for an individual or small group, you can hide a conventional bomb near the target, or assault their position directly, but sometimes it is best to catch them unaware with unconventional methods. There are three excellent methods to accomplish this which will be outlined over the next pages. Additionally, consider the following alternatives for assassination: Sniping, RPG/Rocket, Artillery, Landmine, Booby trap (Mantraps can be found in Ragnar Benson's Big Book of Homemade Weapons (1992, Paladin Press) or in Ragnar Benson's MANTRAPPING also from Paladin Press), Arson (including gas explosion), Poison (dart, syringe, contact, food), Accident (loosening wheels, tipping heavy weights when passing, running over with car etc.). There are many guides available on this topic online, here unconventional bombs will be covered.

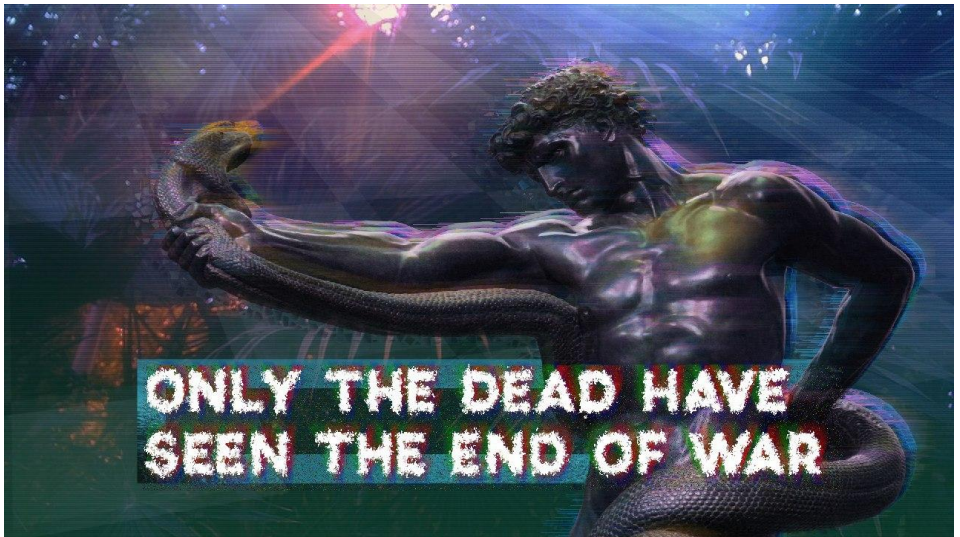

In this issue we will present to you 3 different recipes for your Home Assassination operation:

1. Parcel/Package Bomb.
2. Magnetic Car Bomb.
3. DoorTrap Bomb.



A

PREPARING THE ELECTRIC CIRCUIT.

We will need a **push switch** found in many electric lamps as shown here or any other similar **push switch**. The following are important conditions to observe when obtaining the switch.

1. When you first push and hold the push switch, the circuit does not connect. When releasing your finger from the Push-Switch the circuit connects hence switching on the lamp.
2. The Push-Switch selected should be easy to press, not requiring too much pressure. The easier and lighter it is when pressing the safer.



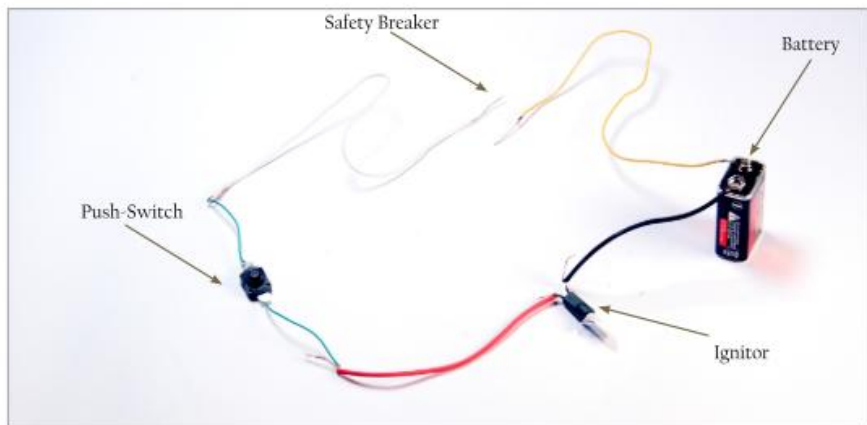

This is the main circuit, its main components are:

(1) - Battery. (2) - Ignitor. (3) - Push Switch. (4) - Safety Breaker.

B

PREPARING THE PACKAGE BOMB.

We will use this book and turn it to a package bomb, such that it will explode when opened. Below are the steps to follow in preparing the book.



1. The size of the book should be proportional to the size of the bomb being placed inside.



2. Draw a boarder and start cutting the pages as shown above.



3. This book is ready for the Bomb Trap.



4. We will use piece of wood to fix the switch button in the appropriate place.



We place this wooden piece directly opposite to the switch.

5. Fix the Push-Switch in the wooden piece using glue.



6. Fix the wooden piece in its suitable place in the Book.



When the book is closed the circuit is switched off.

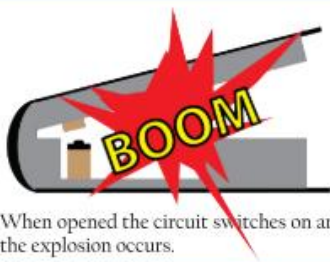

When opened the circuit switches on and the explosion occurs.

Reference Issue 14



Please refer to Issue 14 ('Assassination operations') for the recipe on how to make this Pipe-Bomb.

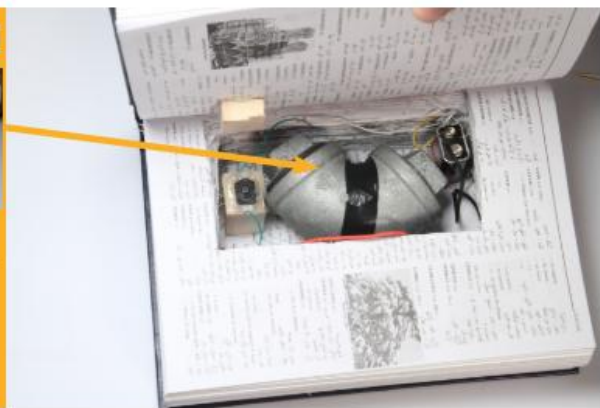

7. We place all the bomb parts inside the book, and fix them properly as shown above.



8. We have to carefully remove these two wires from the back of the book as shown above without making a connection. You can wrap them up with sellotape, so as to avoid unnecessary contact.



We remove the safety wires from the back of the book (as shown in the figure). These wires when in contact, the electric circuit will be active, and what is left is for the book to be opened and the explosion to occur. The importance of the safety wires is to prevent any accidents in case of any mistake i.e. if the circuit is connected then these wires will act as a safety and prevent any unnecessary explosions - **SO LONG AS THEY DO NOT COME INTO CONTACT.**



To be sure that no mistake takes place, stay at a safe distance and separate yourself and the book using a thick wall. Extend a wire from each end of the safety-wires (from the book). Place the book behind a wall and connect the wires together. If, by the will of Allah, there is a mistake then the bomb will explode from a safe distance behind a wall.

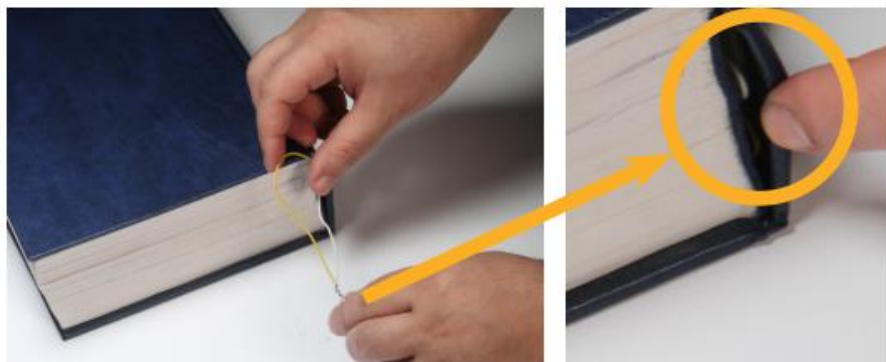

10. After being sure that the electric circuit is safe we connect the safety wires and hide them inside the hard-cover , on one of the ends of the book as shown above

! You MUST experiment using a test lamp before actually connecting the explosive device. So as to confirm if the circuit is working.



When the book is closed the circuit is off.



When opened the circuit is on and the test-lamp switches on.



Cover the book so as to prevent any unnecessary opening of the book which will cause unintended explosion.

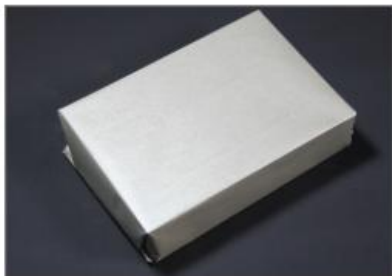

Final picture of the book after covering



These are different types of packages you can chose from depending on the size of the bomb and weight of package.

2

Magnetic Car Bomb



This is a small quantity explosive device that can be carried by hand. When placed under the car it will kill the one above it.

A

PREPARING THE ELECTRIC CIRCUIT.

(a)

Preparing the Electric Wind Switch.

It is a switch ignited by the wind generated by the car when moving at speed.



1. Cut a rectangular piece of paperboard as shown above.



2. Place a piece of carton on one end of the rectangular paperboard.



3. Place an electric wire on the paperboard as illustrated above.



4. Cut a piece of metal the same size as the paperboard.
5. Tie the metal piece with a wire.
6. Connect the wire to a toggle-switch (on/off switch)



7. Connect the paperboard to the metal piece in such that the carton acts as a separator between the two.



8. The switch is now ready, when the carton piece is connected to the metal the circuit will be connected (on).

(b) Preparing the Detonator.



1. Insert an ignitor (made from decoration lamp) inside the detonator and tape well with sellotape.

Reference Issue 13

We have already explained how this is done in Issue #13 (Neurotmesis) - Please refer to it for the explanation.



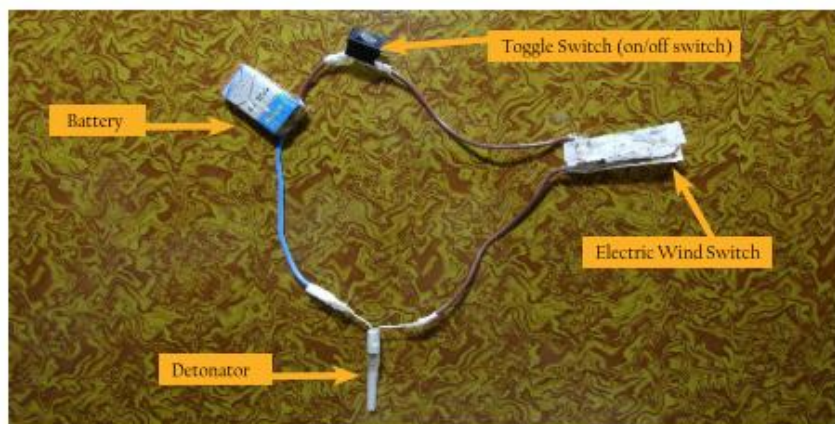

2. Connect together all parts of the circuit.

B

CONNECTING THE ELECTRIC CIRCUIT TO THE EXPLOSIVE DEVICE.

We will use the explosive device explained in Issue 13, as for the detonator we will use an electric detonator.

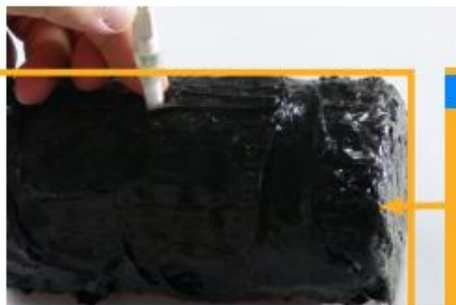

Reference Issue 13

We have already explained how this is done in Issue #13 (Neurotmesis) - Please refer to it for further explanation.





1. We insert the detonator at the center of the explosive device, as shown above.



2. We fix all the electric circuit in the device as shown above.

We place the wind switch in front of the bomb to face the direction of the wind when the car moves.

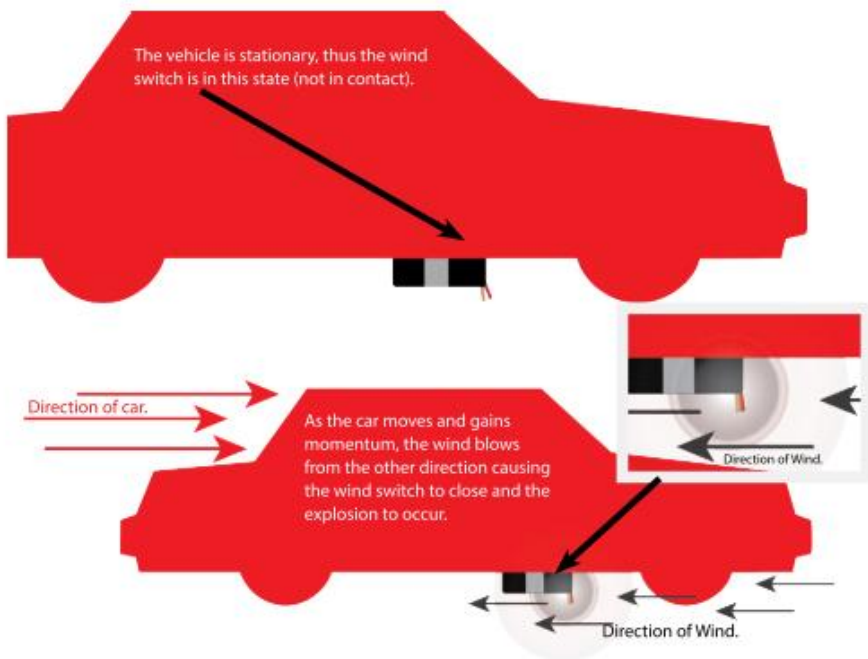

C

PREPARING THE MAGNET



1. We remove a magnet from a car Antenna or any other suitable magnet e.g. from electric speakers.



2. The magnet after being removed from the antenna.



3. Cut any metallic soda can to a rectangular shape.



4. Glue the magnet to the cut metal piece as shown above.



5. Finally fix the magnet in the explosives, as shown above. And the bomb is now ready for use.



HOW IT WORKS

- Place the explosives at an appropriate place under the car and turn on the electric switch
- As the car speeds the wind coming from the opposite direction will push the paperboard to make it contact the metal piece and thus connecting the circuit and the explosion occurs.



WE WON'T FAIL AGAIN





A

PREPARING THE ELECTRIC CIRCUIT



1. We need 2 strong solid wires (single-strand wire), and shape them as seen above.



2. Insert one of the wires into the other as illustrated above.

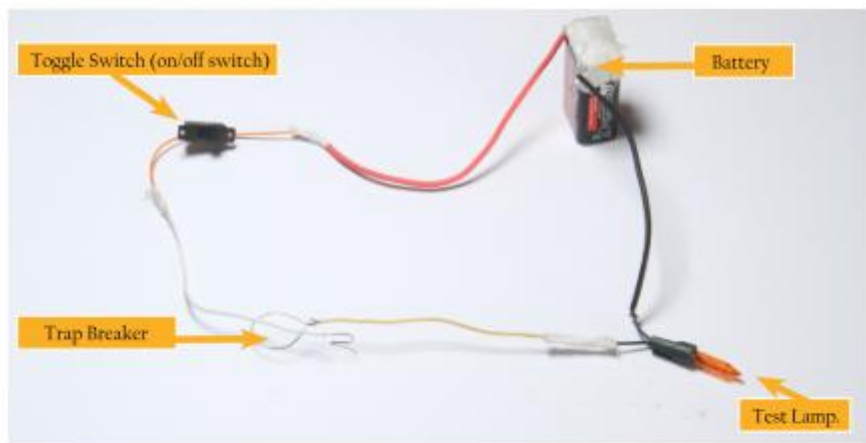

3. We connect the electric circuit as shown above.

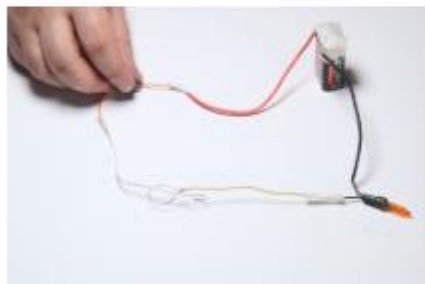

4. Switch on the toggle switch.

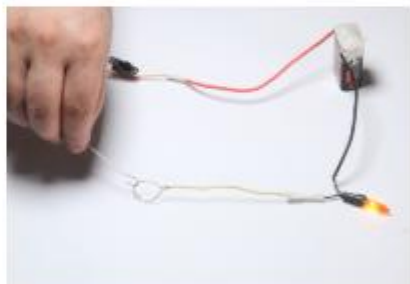

5. Pull the trap wire. If the test lamp lights this means that the circuit is ok.



6. Instead of the test lamp we will place a delayed ignitor explained in the last issue (Refer to Issue#14).



7. We will use the same pipe bomb we used in Issue#14



Reference Issue 14

Please refer to Issue 14 ('Assassination operations') for the recipe on how to make this Pipe-Bomb, and the delayed ignitor.



8. We will use this adhesive cloth hook to hang the bomb above the door.

9. One end of this red string should be fixed on the door and the other end to the yellow wire. As the door is opened, the red string will pull the yellow wire which will be hooked by the white wire, thus making a connection and explode the pipe bomb.



The white wire is fixed on the explosives.

When the fuse ignites it will take approximately 3 seconds for the bomb to explode. This is enough to make the body of the person to be in the target area. i.e. outside of the door, thus making all of his body vulnerable to the explosive effect.

5. Car and Truck Bombs

Car bombs are an effective tool to decimate a target of considerable size. They have been used to great effect both as suicide IEDs by jihadis and remotely by revolutionaries like Anders Breivik. There is no one size fits all approach to creating a car bomb. If you expect to encounter gunfire then you will have to consider adding considerable armour and adopting a driving style which suits the added weight and loss to manoeuvrability. The ideal car bombing mission involves remote detonation of a parked vehicle. Another modern technique, pioneered on the battlefields of Syria, is remote controlling the payload vehicle, though that is outside of the scope of this guide.



Car Bomb Basics

Ingredients:

- Newspaper
 - Fertilizer (the chemical kind, Ammonium Nitrate)
 - Cotton
 - Diesel fuel
- A vehicle which has been mostly gutted internally for more space

Make a pouch out of the newspaper and put some fertilizer in it.

Then put cotton on top. Soak the cotton with fuel. Then light or remotely ignite the mixture.

Preparing the vehicle

Put blinds or some sort of covers on the side windows except the rear window and the front side including windscreen. Inspect the car from all angles, can the fertilizer bags be easily seen? If so cover them with a blanket. Windowless vans are ideal for this reason. When driving to your target follow all traffic laws. If using a fake delivery van, dress and act the part.

Al Qaeda Style Car Bombs

The following is taken from the 12th edition of the Al Qaeda magazine Inspire! If you can look past the islamic angle you will recognize a helpful and discreet approach to car bombing in countries where access to materials is strictly monitored. As mentioned, this profile of bomb is strictly for killing individuals, causing a crowd to move in a particular direction or as a major distraction while you accomplish another objective. Unlike Al Qaeda, we do not target civilians based on religion. Religion is a non-issue. Rather we target them based on their political allegiance. Be sure to park this outside a gathering of jews and/or marxists for optimum results.



CAR BOMBS INSIDE AMERICA

w/ AQ Chef

REQUIRED COMPONENTS

- Cooking Gas Cylinder (6 or more)
- Oxygen Gas Cylinder (full)
- Barometer (suiting the Cooking Gas Cylinder)
- Connecting nut and pipe
- 6 Decoration lamps
- Match
- Epoxy
- Tissue
- Battery (12v or more)
- Wire



Epoxy



Decoration Lamp



Barometer



Connecting Nut

Inspire Magazine's goal is to empower Muslim youth. And what is empowerment without being strong, powerful and intelligent? In this section, we give you strength, power and intelligence. Believe me, using car bombs gives you all that.

It is absolutely simple. And we will make it simpler for you, *bidadhnullah*, so that every Muslim, who loves Allah and His Messenger, and wants to accelerate Islam's victory, becomes prepare to make, even if this is the first military material his eyes has set on.

This recipe gives you the ability to make a car bomb even in countries with tight security and surveillance. The reason is: primary materials easily available and they do not raise suspicion. These materials are not explosives in nature. But after you have assemble and prepare them, they become a bomb ready for destruction, *bidadhnullah*.

This type of car bomb is not usually used to destroy buildings, but is very effective in killing individuals.

The merit of this method is that you can prepare a car bomb in a few hours during the availability of the primary materials. So there is less worry about your personal security.

My Muslim brother, before you start reading the instructions, remember that this type of operation if prepared well and an appropriate target is chosen and Allah decrees success for you, history will never forget it. It will be recorded as a crushing defeat on the enemies of Islam.

THE GENERAL IDEA:

We are going to mix two gases; one an oxidizer, another a fuel, in one sealed container that will change the normal combustion of the two materials into an explosive combustion. The explosion will start as soon as a flame emitted from a torch comes in contact with the gas that will burn rapidly under very high pressure.



Cooking Gas Cylinder



Oxygen Gas Cylinder

OPERATIONAL IDEA:

- Pure 'Oxygen' was used as the oxidizing gas, cooking gas 'Propane' as the fuel, and Cooking Gas Cylinder as the sealed container.
- An amount of gas was discharged from the Cooking Gas Cylinder.
- The highly pressurized Oxygen Cylinder was connected to the Cooking Gas Cylinder.
- When the safety valves of both the cylinders were opened, Oxygen Gas moved into the Cooking Gas Cylinder directly. This was caused by pressure difference.
- The pressure inside the Oxygen Cylinder was very high compared to that inside the Cooking Gas Cylinder. We know that gas moves from a high pressure region to a lower pressure region.

PRESSURE DIFFERENCE:

- While the tap is closed, the pressure in the yellow balloon is zero, while the pressure in the red balloon is one.



Closed Tap



Opened Tap

- But when we open the tap, gas moves from the high pressure region (red balloon) to the low pressure region (yellow balloon) in such the pressures in the two balloons become equal.

BAROMETERS:

Pressure measuring instruments are called 'barometers'.

There are different types of barometers, some measure up to 11 bars, others up to 280 bars, and others in between. Barometers used to measure tire pressure usually measure up to 11, 12 or 16 bars.

Barometers used for gas cylinders differ as per the type of the cylinder. For example, large Oxygen cylinders use barometers of 240 bars or 280 bars. Medium cooking gas cylinders use barometers of 34 or 36 bars. There are also many other types of barometers.

Barometers use different units, some use bars, others 'atm', pound per square inch (psi), Pascals (Pa) or millimeter of mercury (mmHg).

Here are some barometers:



Regulator

1. This barometer is sometimes called a 'regulator'. We will use it in these instructions. The meter on the right measures the pressure in the oxygen cylinder - its maximum measurement is 28,000 kiloPascals (kPa), equivalent to 280 bars. While the meter on the left measures the cooking gas cylinder - its maximum measurement is 1400 kPa, equivalent to 14 bars.

PRESSURE UNITS:

- The standard atmosphere that we live in is a unit of pressure.
- The standard atmosphere is almost equal to one bar (1 bar = 1 atm).
- In this procedure we are going to use 'bar' as the standard pressure unit for the gas cylinders.
- When you come across any other unit in your barometer e.g. Pascals, kiloPascals or psi, convert it into bar.
- Conversion is very simple, all you have to do is use a converter in your computer OS calculator.
- A Cooking Gas Cylinder can sustain up to 12 bars.
- An Oxygen Cylinder can sustain up to 135 bars.
- 'kg/cm²' is the same as atm (atmosphere).

HINT

- You can use oxygen from medical or welding cylinders.
- You can also use other fuels instead of propane, e.g. hydrogen, methane or acetylene.
- These fuels give better results, if security measures allow you to buy.



Tire Barometer

2. This tire barometer can measure up to 11 bars. We will use it in our procedure.



Regulator 2

3. The meter on the right measures a maximum of 25 atmospheres - almost equivalent to 25 bars, while the meter on the left measures a maximum of 2.5 atmospheres - almost equivalent to 2.5 bars.



Tire Barometer 2

4. This tire barometer can measure a maximum of 16 bars.



DID YOU KNOW?

that you can mix the two gases in one Welding-Oxygen Cylinder? An oxygen cylinder can sustain more than 12 Cooking Gas Cylinders of 25-liters. BUT do not forget the balloon principle.

CAR BOMB PREPARATION:

1 - Mixing the Gases:

- Discharge gas from the Cooking Gas Cylinder until only 3 bars are left in it.
- Note: to be sure of the required amount, you have to measure the pressure after every few moment of releasing the gas. Use a barometer suitable for the cooking gas cylinder.
- Note: If you do not have the suitable barometer, there is a simple way to measure the pressure by a tire barometer (fig 1.1):
- Take a normal cooking gas regulator and cut its connecting nut off. Use a hacksaw to cut at the yellow mark. (fig 1.2)
- Take a tire's inner tube and cut the valve stem off, in such its lower part fits the nut. (fig 1.3)
- Fit the valve stem into the nut precisely.
- Apply epoxy from the outside to provide a strong adhesion between the valve stem and the nut and prevent the gas from leaking. Also apply a little of epoxy inside - Do not block the hole. Now the nut is ready to use with the tire barometer and the Cooking Gas Cylinder. (fig 1.4)



1.1. Tire Barometer



1.2. Cooking Gas Regulator



1.3. Nut and Valve



1.4. Final Result

2- Connect the Oxygen Cylinder to the Cooking Gas Cylinder.



Connecting Nut

Note: to be able to insert Oxygen Gas into the Cooking Gas Cylinder, you should have the connecting nut illustrated in the photo.

If the connector is unavailable, or buying it may draw attention to you, you can use a normal cooking gas regulator with a bit of modification. You will have to drill a hole from the inside to let Oxygen Gas pass into the cylinder.



2.1. Interior Spot



2.2. Exterior Spot

3 - Insert 9 bars of Oxygen Gas into the Cooking Gas Cylinder.

This will make the total pressure inside the Cooking Gas Cylinder 12 bars. (fig 2.3)

Avoid heat and fire sources while inserting or discharging gas!



2.3. Inserting Oxygen

4 - Preparing the ignition lamp:

- The ignition lamp is the tool that emits a flame into the mixed gas inside the Cooking Gas Cylinder, to detonate the bomb.
- Break the top of the decoration lamp by heating it. Make sure the filament does not break.
- Fill the lamp with match (from matchstick heads). (fig 3.1)
- Seal it with a tissue. (fig 3.2)



3.1. Match in Lamp



3.2. Sealing



SECURITY MEASURES:

- If you are planning to hide your identity and cover your trail during the operation, begin from the time you set your feet to purchase the ingredients.
- Wipe your fingerprints.
- Use a car that will not reveal your identity.
- Avoid CCTV cameras.

FIG : 2.1 & 2.2

The spot to be drilled.

HINT

You can collect the gas in one Cooking Gas Cylinder instead of six cylinders, as long as the pressure is not lower than 12 bars. The higher the gas pressure the stronger the explosion.

IMPORTANT



It is better to start preparing the car bomb few hours before the operation, because the security forces (if they come into your work place/house) cannot accuse you of preparing a bomb, especially if you distribute the ingredients in your house well.

FIG : 4.1

A Cooking Gas Cylinder Bomb.
You have completed the preparation of one cylinder, now prepare the other cylinders in the same way (to make a total of not less than six).

MAXIMUM CARNAGE



- It is better to use shrapnel (nuts, ball bearings, nails or any other) on the outer surface of the cylinders.
- The best way to arrange the shrapnel is in circles.
- In this car bomb you can use up to 100,000 pieces of shrapnel.
- A hand grenade usually contains 360 shrapnel only.

5 - Inserting the ignition lamp

- Insert the lamp into the connector, while the wires are out.
- Apply epoxy to seal the connector or the modified regulator.



Ignition lamp in connecting nut



Ignition lamp in modified regulator

- Fasten the connector to mixed gas cylinder.



4.1. Cooking Gas Cylinder Bomb

6 - Preparing the Car-Bomb:

- Prepare no less than six 25-litre cylinders.
- Place them closely to each other. Leave as little space between them as possible.
- Connect the ignition lamps.



Car Bomb without Electrical Circuit

7- Preparing the electric circuit: (connecting the cooking gas cylinders)

Every ignition lamp has two wires. Connect the wires on the right to the positive pole (+) of the battery (12v or more), and the wires on the left to the negative pole (-).

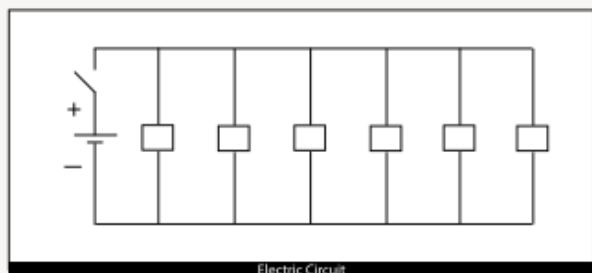

Electric Circuit



- When these two wires are connected to the battery the car will explode.
- **THAT IS WHY YOU SHOULD PUT A SWITCH ON THE POSITIVE SIDE SO THAT YOU CAN CONTROL WHEN TO DETONATE THE CAR BOMB, AND PROTECT THE CIRCUIT FROM UNINTENDED DETONATION.**
- Note: It is recommended to test the electric circuit using another decoration lamp of the same type used for ignition.
- If you are a martyrdom bomber and you want to detonate the car bomb directly, use a manual switch that is operated by hand directly.
- If you want to make it a time bomb, use a time switch (you can refer to Inspire Magazine issue 1 and 9 for details).
- If you want a remote detonation, use a toy-car remote, alarm remote, garage remote or any other. You can test the remote with a lamp (or refer to issue 8 for details).

That's all there is to it



REMEMBER

If you intend to hide your identity buy a car without any formal paperwork being exchanged.

IMPORTANT



If it possible, carry out an experiment even if in a smaller scale in a safe place, because an experiment will give you lot of experience before the main operation.

IMPORTANT



This type of car bomb is used to kill individuals and NOT to destroy buildings.

Therefore, look for a dense crowd.

Logic

When targeting high profile places, go for the entrance; you cannot get a car into most of these targets. But what goes in, comes out; there should be an entrance.

REMEMBER



Disguise yourself during the operation, appear fat (add some clothes on you), change your complexion, be a 'clone', use any mask (believe me embarrassment is the last thing you will think about), wear a mask suitable for the festival, white beards on 25th Dec. All in all, be creative brother. The most important part to hide is your eyes and around.

6. Caching/Secure Storage

Taken from TC 31-29/A U.S. ARMY SPECIAL FORCES CACHING TECHNIQUES Originally published in "Soldier of Fortune"

Caching is the process of hiding equipment or materials in a secure storage place with the view to future recovery for operational use. The ultimate success of caching may well depend upon attention to detail, that is, professional competence that may seem of minor importance to the untrained eye. Security factors, such as cover for the caching party, sterility of the items cached, and removal of even the slightest trace of the caching operations are vital. Highly important, too, are the technical factors that govern the preservation of the items in usable condition and the recording of data essential for recovery. Successful caching entails careful adherence to the basic principles of clandestine operations, as well as familiarity with the technicalities of caching.

Section 1: Caching Considerations

Caching considerations that are vital to the success of the caching operation may be done in a variety of operational situations. For example, cached supplies can meet the emergency needs of personnel who may be barred from their normal supply sources by sudden developments or who may need travel documents and extra funds for quick escape. Caching can help solve the supply problems of long-term operations conducted far from a secure base. Caching also can provide for anticipated needs of wartime operations in areas likely to be overrun by the enemy.

PLANNING FOR A CACHING OPERATION

Caching involves selecting items to be cached, procuring those items, and selecting a cache site. Selection of the items to be cached requires a close estimate of what will be needed by particular units for particular operations. Procurement of the items usually presents no special problems. In fact, the relative ease of procurement before an emergency arises is one of the prime considerations in favor of caching. When selecting a cache site, planners should always ensure that the site is accessible not only for emplacement, but also for recovery. When planning a caching operation, the planner must consider seven basic factors.

1. Purpose and Contents of the Cache.

Planners must determine the purpose and contents of each cache because these basic factors influence the location of the cache, as well as the method of hiding. For instance, small barter items can be cached at any accessible and secure site because they can be concealed easily on the person once recovered. However, it

would be difficult to conceal rifles for a Guerrilla Band once recovered. Therefore, this site must be in an isolated area where the band can establish at least temporary control. Certain items, such as medical stock, have limited shelf life and require rotation periodically or special storage considerations, necessitating easy access to service these items. Sometimes it is impossible to locate a cache in the most convenient place for an intended user. Planners must compromise between logistical objectives and actual possibilities when selecting a cache site. Security is always the overriding consideration.

2. Anticipated Enemy Action.

In planning the caching operation, planners must consider the capabilities of any intelligence or security services not participating in the operation. They should also consider the potential hazards the enemy and its witting or unwitting accomplices present. If caching is done for wartime operational purposes, its ultimate success will depend largely on whether the planners anticipate the various obstacles to recovery, which the enemy and its accomplices will create if the enemy occupies the area. What are the possibilities that the enemy will preempt an ideal site for one reason or another and deny access to it? A vacant field surrounded by brush may seem ideal for a particular cache because it is near several highways. But such a location may also invite the enemy to locate an ordnance depot where the cache is buried.

3. Activities of the local Population.

Probably more dangerous than deliberate enemy action are all of the chance circumstances that may result in the discovery of the cache. Normal activity, such as construction of a new building, may uncover the cache site or impede access to it. Bad luck cannot be anticipated, but it can probably be avoided by careful and imaginative observation of the prospective cache site and of the people who live near the site. If the cache is intended for wartime use, the planners must project how the residents will react to the pressures of war and conquest. For example, one of the more likely reactions is that many residents may resort to caching to avoid having their personal funds and valuables seized by the enemy. If caching becomes popular, any likely cache site will receive more than normal attention.

4. Intended Actions by Allied Forces.

Using one cache site for several clandestine operations involves a risk of mutual compromise. Therefore, some planners should rule out otherwise suitable caching sites if they have been selected for other clandestine purposes, such as drops or safe houses. A site should not be located where it may be destroyed or rendered inaccessible by bombing or other allied military action, should the area be occupied by the enemy. For example, installations likely to be objects of special protective efforts by the occupying enemy are certain to be inaccessible to the ordinary citizen. Therefore, if the cache is intended for wartime use, the caching party should avoid areas such as those near key bridges, railroad intersections,

power plants, and munitions factories.

5. Packaging and Transportation Assets.

Planners should assess the security needs and all of the potential obstacles and hazards that a prospective cache site can present. They should also consider whether the operational assets that could be used for packaging and transporting the package to the site. Best results are obtained when the packaging is done by experts at a packaging center. The first question, therefore, is to decide whether the package can be transported from the headquarters or the field packaging center to the cache site securely and soon enough to meet the operational schedules. If not, the packaging must be done locally, perhaps in a safe house located within a few miles of the cache site. If such an arrangement is necessary, the choice of cache sites may be restricted by limited safe house possibilities.

6. Personal Assets.

All who participate directly in emplacement will know where the cache is located. Therefore, only the fewest possible and the most reliable persons should be used. Planners must consider the distance from the person's residence to the prospective cache site and what action cover is required for the trip. Sometimes transportations and cover difficulties require the cache site to be within a limited distance of the person's residence. The above considerations also apply to the recovery personnel.

7. Caching Methods.

Which cache method to use depends on the situation. It is therefore unsound to lay down any general rules, with one exception. Planners should always think in terms of suitability, for example, the method most suitable for each cache, considering its specific purpose; the actual situation in the particular locality; and the changes that may occur if the enemy gains control.

Concealment.

Concealment requires the use of permanent man-made or natural features to hide or disguises the cache. It has several advantages. Both employment and recovery usually and be done with minimum time and labor, and cached items concealed inside a building or dry cave are protected from the elements. Thus, they require less elaborate packaging. Also, in some cases, a concealed cache can be readily inspected from time to time to ensure that it is still usable. However, there is always the chance of accidental discovery in addition to all the hazards of wartime that may result in discovery or destruction or a concealed cache or denial of access to the site. The concealment method, therefore, is most suitable in cases where an exceptionally secure site is available or where a need for quick access to the cache justifies a calculated sacrifice in security. Concealment may range from securing small gold coins under a tile in the floor to walling up artillery in caves.

Burial. Adequate burial sites can be found almost anywhere. Once in place, a properly buried cache is generally the best way of achieving lasting security. In contrast to concealment, however, burial

in the ground is a laborious and time-consuming method of caching. The disadvantages of burial are that burial almost always requires a high-quality container or special wrapping to protect the cache from moisture, chemicals and bacteria in the soil. Emplacement or recovery of a buried cache usually takes so long that the operation must be done after dark unless the site is exceptionally secluded. It is especially difficult to identify and locate a buried cache.

Submersion. Submersion sites that are suitable for secure concealment of a submerged cache are few and far between. Also, the container of a submerged cache must meet such high standards for waterproofing and resistance to external pressure that the use of field expedients is seldom workable. To ensure that a submerged cache remains dry and in place, planners must determine not only the depth of the water, but the type of bottom, the currents, and other facts that are relatively difficult for nonspecialists to obtain. Emplacement, likewise requires a high degree of skill. At least two persons are needed for both emplacement and requires additional equipment. In view of the difficulties - especially the difficulty of recovery - the submersion method is suitable only on rare occasions. The most noteworthy usage is the relatively rare maritime re-supply operation where it is impossible to deliver supplies directly to a reception committee. Caching supplies offshore by submersion is often preferable to sending a landing party ashore to bury a cache.

SELECTION OF THE SITE

The most careful estimates of future operational conditions cannot ensure that a will cache will be accessible when it is needed. However, criteria for a site selection can be met when three questions are answered.

1) Criteria for Site Selection

Can the site be located by simple instructions that are unmistakably clear to someone who has never visited the location? A site may be ideal in every respect, but if it has no distinct, permanent landmarks within a readily measurable distance it must be ruled out. Are there at least two secure routes to and from the site? Both primary and alternate routes should provide natural concealment so that the emplacement party and the recovery party can visit the site without being seen by anyone normally in the vicinity. An alternate escape route offers hope of avoiding detection and recovered at the chosen site in all seasons? Snow and frozen ground create special problems. Snow on the ground is a hazard because it is impossible to erase a trail in the snow. Planners must consider whether seasonal changes in the foliage will leave the site and the dangerously exposed.

2) The Map Survey

Finding a cache site is often difficult. Usually, a thorough systematic survey of the general area designated for the cache is required. The survey is best done with a large-scale map of the area as is available. By scrutinizing the map, the planners can determine whether a particular sector must be ruled out because of its

nearness to factories, homes, busy thoroughfares, or probable military targets in wartime. A good military-type map will show the positive features in the topography; proximity to adequate roads or trails, natural concealment (for example: surrounding woods or groves), and adequate drainage. A map also will show the natural and man-made features in the landscape. It will provide the indispensable reference points for locating a cache site: confluences of streams, dams and waterfalls, road junctures and distance markers, villages, bridges, churches, and cemeteries.

3) The Personal Reconnaissance.

A map survey normally should show the location of several promising sites within the general area designated for the cache. To select and pinpoint the best site, however, a well-qualified observer must examine each site firsthand. If possible, whoever examines the site should carry adequate maps, a compass, a drawing pad or board for making sketch maps or tracings, and a metallic measuring line. (A wire knotted at regular intervals is adequate for measuring. Twine or cloth measuring tapes should not be used because stretching or shrinking will make them inaccurate if they get wet.) The observer should also carry a probe rod for probing prospective burial sites, if the rod can be carried securely. Since the observer seldom completes a field survey without being noticed by local residents, his action cover is of great importance. His cover must offer a natural explanation for his exploratory activity in the area. Ordinarily, this means that an observer who is not a known resident of the area can pose as a tourist or a newcomer with some reason for visiting the area. However, his action cover must be developed over an extended period before he undertakes the actual reconnaissance. If the observer is a known resident of the area, he cannot suddenly take up hunting, fishing, or wildlife photography without arousing interest and perhaps suspicion. But he must build up a reputation for being a devotee of his sport or hobby.

4) Reference Points.

When the observer finds a suitable cache site, he prepares simple and unmistakable instructions for locating the reference points. These instructions must identify the general area (the names of general recognizable places, from the country down to the nearest village) and an immediate reference point. Any durable landmark that is identified by its title or simple description can be immediate reference point (for example, the only Roman Catholic church in a certain village or the only bridge on a named road between two villages). The instructions must also include a final reference point (FRP), which must meet four requirements:

- 1) It must be identifiable, including at least one feature that can be used as a precise reference point.
- 2) It must be an object that will remain fixed as long as the cache may be used.
- 3) It must be near enough to the cache to pinpoint the exact location of

the cache by precise linear measurements from the FRP to the cache.

4) It should be related to the immediate reference point by a simple route description, which proceeds from the immediate reference point to the FRP. Since the route description should be reduced to the minimum essential, the ideal solution for locating the cache is to combine the immediate reference point and the FRP into one landmark readily identifiable, but sufficiently secluded. The following objects, when available, are sometimes ideal reference points: small, unfrequented bridges, and dams, boundary markers, kilometer markers and culverts along unfrequented roads, a geodetic survey marker, battle monuments, and wayside shrines. When such reference points are not available at an otherwise suitable cache site, natural or man-made objects may serve as FRP's: distinct rocks, posts for power or telephone lines, intersections in stone fences or hedgerows, and gravestones in isolated cemeteries.

5) Pinpointing Techniques.

Recovery instructions must identify the exact location of the cache. These instructions must describe the point where the cache is placed in terms that relate in to the FRP. When the concealment method is used, the cache ordinarily is placed inside the FRP, so it is pinpointed by a precise description of the FRP. A submerged cache usually is pinpointed by describing exactly how the moorings are attached to the FRP. With a buried cache, any of the following techniques may be used.

Placing the cache directly beside the FRP. The simplest method is to place the cache directly beside the FRP. Then pinpointing is reduced to specifying the precise reference point of the FRP. Sighting the cache by projection, This method may be used if the FRP has one flat side long enough to permit precise sighting by projecting a line along the side of the object. The burial party places the cache a measured distance along the sighted line. This method may also be used if two precise FRP's are available, by projecting a line sighted between the two objects. In either case, the instructions for finding the cache must state the approximate direction of the cache from the FRP. Since small errors in sighting are magnified as the sighted line is extended, the cache should be placed as close to the FRP as other factors permit. Ordinarily this method becomes unreliable if the sighted line is extended beyond 50 meters.

6) Placing the cache at the intersection of measured lines.

If two FRP's are available within several paces, the cache can be one line projected from each of the FRP's. If this method is used, state the approximate direction of the cache from each FRP. To ensure accuracy, neither of the projected lines (from the FRP's to the point of emplacement) should be more than twice as long as the base line (between the two FRP's). If this proportion is maintained, the only limitation upon the length of the projected lines is the length of the measuring line that the recovery party is expected to carry. The recovery party should carry two measuring lines when this method is used. Sighting the cache by compass

azimuth. If the above methods of sighting are not feasible, one measured line may be projected by taking a compass azimuth from the FRP to the point where the cache is placed. To avoid confusion, use an azimuth to a cardinal point of the compass (north, east, south, or west). Since compass sightings are likely to be inaccurate, a cache that is pinpointed by this method should not be placed more than 10 meters from the FRP.

7) Measuring Distances

The observer should express all measured distances in a linear system that the recovery party is sure to understand - ordinarily the standard system for the country where the cache is located. He should use whole numbers (6 meters, not 6.3 or 6.5, etc.) to keep his instructions as brief and as simple as possible. To get an exact location for the cache in whole numbers, take sightings and measurements first. If the surface of the ground between the points to be measured is uneven, the linear distance should be measured on a direct line from point to point, rather than by following the contour of the ground. This method requires a measuring line long enough to reach the full distance from point to point and enough to be pulled taut without breaking.

8) Marking Techniques

The emplacement operation can be simplified and critical time saved if the point where the cache is to be buried is marked during the reconnaissance. If a night burial is planned, the point of emplacement may have to be marked during a daylight reconnaissance. This method should be used whenever operational conditions permit. The marker must be an object that is easily recognizable but that is meaningless to an unwitting observer. For example, a small rock or a branch with its butt placed at the point selected for the emplacement may be used.

During a personal reconnaissance, the observer must not only pinpoint the cache site, but also gather all the incidental information required for planning the emplacement operation. It is especially important to determine the best route to the site and at least one alternate route, the security hazards along these routes, and any information that can be used to overcome the hazards. Since this information is also essential to the recovery operation, it must be compiled after emplacement and included in the final cache report. Therefore, the observer should be thoroughly familiar with the Twelve-Point Cache Report before he starts a personal reconnaissance. This report is a checklist for the observer to record as much information as possible. Points 6 through 11 are particularly important. The personal reconnaissance also provides an excellent opportunity for a preliminary estimate of the time required for getting to the site.

9) The Alternate Site

As a general rule, planners should select an alternate site in case unforeseen difficulties prevent use of the best site. Unless the primary site is in a completely

deserted area, there is always some danger that the emplacement party will find it occupied as they approach, or that the party will be observed as they near the site. The alternate site should be far enough away to be screened from view from the primary site, but near enough so that the party can reach it without making a second trip.

10) The Concealment Site

A site that looks ideal for concealment may be revealed to the enemy for that very reason. Such a site may be equally attractive to a native of an occupied country to hide his valuables. The only real key to the ideal concealment site is careful casing of the area combined with great familiarity with local residents and their customs. The following is a list of likely concealment sites:

- 1) Natural caves and caverns, and abandoned mines and quarries.
- 2) Walls (hidden behind loose bricks or stones or hidden a plastered surface).
- 3) Abandoned buildings.
- 4) Infrequently used structures (stadiums and other recreational facilities, and railroad facilities on spur lines).
- 5) Memorial edifices (mausoleums, crypts, monuments).
- 6) Public buildings (museums, churches, libraries).
- 7) Ruins of historical interest.
- 8) Culverts.
- 9) Sewers.
- 10) Cable conduits.

The concealment site must be equally accessible to the person emplacing and the person recovering. However, visits by both persons to certain interior sites may be incompatible with the cover. For instance, a site in a house owned by a relative of the emplacer may be unsuitable because there is no adequate excuse for the recovery person to enter the house if he has no connection with the owner.

The site must remain accessible as long as the cache is needed. If access to a building depends upon a personal relationship with the owner, the death of the owner or the sale of the property might render it inaccessible. Persons involved in the operation should not be compromised if the cache is discovered on the site. Even if a cache is completely sterile, as every cache should be, the mere fact that it has been placed in a particular site may compromise certain persons. If the cache were discovered by the police, they might suspect the emplacer because it was found in his relative's house. The site must not be located where potentially hostile persons frequently visit. For instance, a site in a museum is not secure if police guards or curious visitors frequently enter the museum.

To preserve the cache material, the emplacer must ensure the site is physically secure for the preservation of the cached material. For example, most buildings involve a risk that the cache may be destroyed or damaged by fire, especially in wartime. The emplacer should consider all risks and weigh them against the advantages of an interior site. A custodian

may serve to ease access to a building or to guard a cache. However, the use of such a person is inadvisable, as a custodian poses an additional security risk. He may use the contents of the cache for personal profit or reveal its location.

11) The Burial Site

In selecting a burial site, consider the following factors along with the basic considerations of suitability and accessibility:

12) Drainage

This includes the elevation of the site and the type of soil. The importance of good drainage makes a site on high ground preferable unless other factors rule it out. Moisture is one of the greatest natural threats to the contents of a cache. Swamp muck is the most difficult soil to work in. If the site is near a stream or river, ensure that the cache is well above the all-year high-water mark so that it will not be uncovered if the soil is washed away.

13) Ground Cover

The types of vegetation at the site will influence the choice. Roots of deciduous trees make digging very difficult. Coniferous trees have less extensive root systems. Also, the presence of coniferous trees usually means that the site is well drained. Does the vegetation show paths or other indications that the site is frequented too much for secure caching? Can the ground cover be easily restored to its normal appearance when burial is completed? Tall grass reveals that it has been trampled, while an overlay of leaves and humus can be replaced easily and will effectively conceal a freshly refilled hole.

14) Natural Concealment

The vegetation or the surrounding terrain should offer natural concealment for the burial and recovery parties working at the site. Planners should carefully consider seasonal variations in the foliage.

15) Types of Soil

Sandy loam is ideal because it is easy to dig and drains well. Clay soil should be avoided because it becomes quite sticky in wet weather and in dry weather it may become so hard that it is almost impossible to dig.

16) Snowfall and Freezing

If the cache must be buried or recovered in winter, data on the normal snowfall, the depth to which the ground freezes in winter, and the usual dates of freezing and thawing will influence the choice of the site. Frozen ground impedes digging and requires additional time for burial and recovery. Snow on the ground is especially hazardous for the burial operation. It is practically impossible to restore the snow over the burial site to its normal appearance unless there is more snowfall or a b risk wind. Also, it is very difficult to ensure that no traces of the

operation are left after the snow has melted.

17) Rocks and Other Subsurface Obstructions

Large obstructions that might prevent use of a particular site can be located to some extent before digging by probing with a rod or stake at the exact spot selected for the cache.

18) The Submersion Site

To be suitable for a submerged cache, a body of water must have certain characteristics. The presence of these characteristics can be determined only by a thorough survey of the site. Their importance will be understood after familiarization with the technicalities of submersion as discussed in Section 3, Emplacement. Submersion usually requires a boat, first for reconnoitering, then for emplacement. Thus, the accessibility problems involved in submersion usually narrow down to the availability of a boat and the action cover for using it. If there is no fishing or pleasure boating at the site the cover for this peculiar type boating may be a real problem. In tropical areas the course of streams or rivers is frequently changed by seasonal rainfall and can cause many problems. Keep this fact in mind when choosing the site and when selecting reference points.

19) Recovery

Since the method for recovering a cache is generally similar to that for emplacing (Section 3) a cache, it need not be described in full. However, several important considerations should be stressed in training for a recovery operation.

20) Practical Exercises

Anyone who is expected to serve as a recovery person should have the experience of actually recovering dummy caches, if field exercises can be arranged securely. It is especially desirable for the recovery person to be able to master the pinpointing techniques. Mastery is best attained by practice in selecting points of emplacement and in drafting, as well as in following instructions.

21) Equipment

Although the equipment used in recovery is generally the same as that used in emplacement, it is important to include any additional items that may be required in recovery in the cache report. A probe rod may not be essential for emplacement, but it is necessary to have some object roughly the same size as the cache container to fill the cavity left in the ground by removal of a buried cache. Some sort of container or wrapping material may be needed to conceal the recovered cache while it is being carried from the cache site to a safe house. Recovery of a submerged cache may require grappling lines and hooks, especially if it is heavy.

22) Sketch of the site

If possible, the observer should provide the recovery person with sketches of the cache site and the route to the cache site. If the recovery person must rely exclusively on verbal instructions, as in the case when communications are limited to radio telephone (RT) messages, he should draw a sketch of the site before starting on the recovery operation. He should use all the data in the verbal instructions to make the sketch as realistic as possible. Drawing a sketch will help to clarify any misunderstanding of the instructions. Also, a sketch can be followed more easily than verbal instructions. It may also be helpful for the recovery person to draw a sketch of the route from the immediate reference point to the site. But he should not carry this sketch on him because if he were apprehended the sketch might direct the enemy to the cache.

23) Preliminary Reconnaissance

Checking the instructions for locating the cache may be advisable, especially when the recovery operation must be performed under stringent enemy controls or when there is no extra time for searching. Careful analysis of the best available map can minimize reconnoitering activity in the vicinity of the cache and thus reduce the danger of arousing suspicion. If recovery must be done at night, the recovery person should find the cache by daylight and place an unnoticeable marker directly over it.

24) Probe Rod

The recovery person can avoid digging at the wrong spot by using a probe rod before starting to dig. He should push and turn the probe rod into the ground by hand, so that it will not puncture the cache's container. Never pound the probe rod with a hammer.

25) Procedure for Digging and Refilling the Hole

The recovery procedure is the same as for the burial, except for two points. First, never use a pick for digging the hole because it might puncture the container and damage the cached items. Second, it may be necessary to fill the hole with other objects in addition to soil after the cache is removed. Sometimes it is possible to fill the hole with rocks, sticks, or other readily available objects at the site. If no such objects are found during the preliminary reconnaissance, the recovery person should carry to the site an object roughly the same size as the cache container.

26) Sterilization of the Site

As with emplacement, the recovery operation must be preformed in such a way that no traces of the operation are left. Although sterilization is not as important for recovery as for emplacement, it should be done as thoroughly as time permits. Evidence that a cache has been recovered might alert the enemy to clandestine activity in the area and provoke countermeasures.

Section 2. Packaging

Packaging usually involves packing the items to be cached, as well as the additional processing in protecting these items from adverse storage conditions. Proper packaging is important because inadequate packaging very likely will render the items unusable. Since special equipment and skilled technicians are needed for best results, packaging should be done at headquarters or a field packaging center whenever possible. However, to familiarize operational personnel with the fundamentals of packaging, so that they can improvise field expedients for emergency use, this section discusses determining factors, steps in packaging, wrapping materials, and criteria for the container. Determining factors.

The first rule of packaging is that all processing is tailored to fit the specific requirements of each cache.

The method of packaging, as well as the size, shape, and weight of the package is determined by the items to be cached, by the method of caching, and, especially, by the way the cache is recovered and used. For instance, if circumstances require one man to recover the cache by himself, the container should be no larger than a small suitcase, and the total weight of container and contents no more than 30 pounds. Of course, these limits must be exceeded with some equipment, but the need for larger packages should be weighed against the difficulties and risks in handling them. Even if more than one person is available for recovery, the material should be divided whenever possible into separate packages of a size and weight readily portable by one man.

Another very important factor in packaging concerns adverse storage conditions. Any or all of the following conditions may be present: moisture, external pressure, freezing temperatures, and the bacteria and corrosive chemicals found in some soil and water. Animal life may present a hazard; insects and rodents may attack the package. If the cache is concealed in an exterior site, larger animals also may threaten it. Whether the packaging is adequate usually depends upon how carefully the conditions at the site were analyzed in designing the cache. Thus, the method of caching (burial, concealment, or submersion) should be determined before the packaging is done.

It is equally important to consider how long the cache is to be used. Since one seldom knows when a cache will be needed, a sound rule is to design the packaging to withstand adverse storage conditions for at least as long as the normal shelf life of the contents to be cached.

STEPS IN PACKAGING

The exact procedure for packaging depends upon the specific requirements for the cache and upon the packaging equipment available. There are Nine Steps that are almost always necessary in packaging.

1) Inspecting

The items to be cached must be inspected immediately before packaging to ensure they are complete, in serviceable condition, and free of all corrosive or

contaminative substances.

2) Cleaning

All corrodible items must be cleaned thoroughly immediately before the final preservative coating is applied. All foreign matter, including any preservative applied before the item was shipped to the field, should be removed completely. Throughout the packaging operation, all contents of the cache should be handled with rubber or freshly cleaned cotton cloves. Special handling is important because even minute particles of human sweat will corrode metallic equipment. Also, any fingerprints on the contents of the cache may enable the enemy to identify those who did the packaging.

3) Drying

When cleaning is completed, every trace of moisture must be removed from all corrodible items. Methods of drying include: wiping with a highly absorbent cloth, heating or applying desiccant. Usually heating is best, unless the item can be damaged by heat. To dry by heating, the item to be cached should be placed in an oven for at least 3 hours at a temperature of about 110°F. An oven can be improvised from a large metal can or drum. In humid climates, it is especially important to dry the oven thoroughly before using it by preheating it to at least 212°F. Then, insert the equipment to be cached as soon as the oven cools down to about 110°F. If a desiccant is used, it should not touch any metallic surface. Silica gel is a satisfactory desiccant, and it is commonly available.

4) Coating With a Preservative

Apply a light coat of oil to weapons, tools, and other items with unpainted metallic surfaces. A coat of paint may suffice for other metal items.

5) Wrapping

When drying and coating are completed, wrap the items to be cached in a suitable material (see paragraph below on Wrapping Materials.) The wrapping should be as nearly waterproof as possible. Each item should be wrapped separately, so that one perforation in the wrapping will not expose all items in the cache. The wrapping should fit tightly to each item to eliminate air pockets, and all folds should be sealed with a waterproof substance.

6) Packing

Several simple rules must be observed when packing items in the container. All moisture must be removed from the interior of the container by heating or applying desiccant. A long-lasting desiccant should be packed inside the container to absorb any residual moisture. If silica gel is used, the required amount can be calculated by using the ratio of 15 kilograms of silica gel to 1 cubic meter of storage space within the container. (This figure is based on two assumptions: the container is completely moisture proof and the contents are slightly moist when

inserted.)

Therefore, the ratio allows an ample margin for incomplete drying and can be reduced if the drying process is known to be highly effective. Air pockets should be eliminated as much as possible by tight packing. Thoroughly dried padding should be used liberally to fill air pockets and to protect the contents from shock. Clothing and other items, which will be useful to the recovery party, should be used for padding if possible. Items made of different metals should never touch, since continued contact may cause corrosion through electrolytic action.

7) Enclosing Instructions for Use of Cached Equipment

Written instructions and diagrams should be included if they facilitate assembly or use of the cached items. Instructions must be written in a language that recovery personnel can understand. The wording should be as simple as possible and unmistakably clear. Diagrams should be self-explanatory since the eventual user may not be able to comprehend written instructions because of language barriers.

8) Sealing & Testing Seals by Submersion

When packing is completed, the lid of the container must be sealed to make it watertight. Testing can be done by entirely submerging the container in water and watching for escaping air bubbles. Hot water should be used if possible because hot water will bring out leaks that would not be revealed by a cold water test.

WRAPPING MATERIALS

The most important requirement for wrapping material is that it be moisture proof. Also, it should be self-sealing or adhesive to a sealing material; it should be pliable enough to fit closely, with tight folds; and it should be tough enough to resist tearing and puncturing. Pliability and toughness may be combined by using two wrappings: an inner one that is thin and pliable and an outer one of heavier material. A tough outer wrapping is essential unless the container and the padding are adequate to prevent items from scraping together inside the cache. Five wrapping materials are recommended for field expedients because they often can be obtained locally and used effectively by unskilled personnel.

1) Aluminum Foil

For use as an inner wrapping, aluminum foil is the best of the widely available materials. It is moisture proof as long as it does not become perforated and provided the folds are adequately sealed. The drawbacks to its use for caching are that the thin foils perforate easily, while the heavy ones (over 2 mils thick) tend to admit moisture through the folds. The heavy-duty grade of aluminum foil generally sold for kitchen use is adequate when used with an outer wrapping. Scrim-backed foil, which is heat-sealable, is widely used commercially to package articles for shipment or storage. Portable heat-sealers that are easy to use are available commercially. Or, sealing can be done with a standard household iron.

2) Moisture-Resistant Papers

Several brands of commercial wrapping papers are resistant to water and grease. They do not provide lasting protection against moisture when used alone, but they are effective as an inner wrapping to prevent rubber, wax and similar substances from sticking to the items in the cache.

3) Rubber Repair Gum

This is a self-sealing compound generally used for repairing tires; it makes an excellent outer wrapping. Standard commercial brands come in several thicknesses; 2 mils is the most satisfactory for caching. A watertight seal is produced easily by placing two rubber surfaces together and applying pressure manually. The seal should be at least 1/2 inch wide. Since rubber repair gum has a tendency to adhere to items, an inner wrapping of non-adhesive material must be used with it, and the backing should be left on the rubber material to keep it from sticking to other items in the cache.

4) Grade C Barrier Material

This is a cloth impregnated with microcrystalline wax that is used extensively when packing for storage or for overseas shipment. Thus, it is generally available, and it has the additional advantage of being self-sealing. Although it is not as effective as rubber repair gum, it may be used as an outer wrapping over aluminum foil to prevent perforation of the foil. Used without an inner wrapping, three layers of grade C barrier material may keep the contents dry for as long as three months, but it is highly vulnerable to insects and rodents. Also, the wax wrapping has a low melting point and will adhere to many items, so it should not be used without an inner wrapping except in emergencies.

5) Wax Coating

If no wrapping material is available, an outer coating of microcrystalline wax, paraffin or a similar waxy substance can be used to protect the contents against moisture. It will not provide protection against insects and rodents. The package should be hot-dipped in the waxy substance, or the wax can be heated to molten form and applied with a brush.

THE CONTAINER

The outer container serves to protect the contents from shock, moisture and other natural hazards to which the cache may be exposed to.

Criteria for the Container The ideal container should be:

- 1) Completely watertight and airtight after sealing.
- 2) Noiseless when handled and its handles should not rattle against the body of the container
- 3) Resistant to shock and abrasion.
- 4) Able to withstand crushing pressure.
- 5) Lightweight in construction.

- 6) Able to withstand rodents, insects, and bacteria.
- 7) Equipped with a sealing device that can be closed and reopened easily and repeatedly.
- 8) Capable of withstanding highly acidic or alkaline soil or water.

1) The Standard Stainless Steel Container

The standard stainless steel container comes in several sizes. Since the stainless steel container is more satisfactory than any that could be improvised in the field, it should be used whenever possible. Ideally, it should be packed at headquarters or at a field packaging center. If the items to be cached must be obtained locally, it is still advisable to use the stainless steel container because its high resistance to moisture eliminates the need for an outer wrapping. Packers should, however, use a single wrapping even with the stainless steel container to protect the contents from any residual moisture that may be present in the container when it is sealed.

2) The Field Expedient Container

Obviously the ideal container cannot be improvised in the field, but the standard military and commercial containers discussed below can meet caching requirements if they are adapted with care and resourcefulness. First, a container must be sufficiently sturdy to remain unpunctured and retain its shape through whatever rough handling or crushing pressure it may encounter. (Even a slight warping may cause a joint around the lid to leak.) Second, if the lid is not already watertight and airtight, packers can make it so by improvising a sealing device. The most common type of sealing device includes a rubber-composition gasket or lining and a sharp metal rim that is pressed against common sealing device is a threaded lid. Its effectiveness can be increased by applying heavy grease to the threads. (Metallic solder should not be used for sealing because it corrodes metal surfaces when exposed to moisture.) Whenever any non-stainless metal container is used, it is important to apply several coats of high-quality paint to all exterior surfaces.

Instrument Containers.

Ordinarily, aircraft and other precision instruments are shipped in steel containers with a waterproof sealing device. The standard instrument containers range from 1/2 gallon to 10 gallon sizes. If one of suitable size can be found, only minimum modifications may be needed. In the most common type of instrument container, the only weak point is the nut and bolt that tightens the locking band around the lid. These should be replaced with a stainless steel nut and bolt.

Ammunition Boxes. Several types and sizes of steel ammunition boxes that have a rubber-gasket closing device are satisfactory for buries caches. An advantage of using ammunition boxes as a cache container, is that they are usually available at a military depot.

Steel Drums. A caching container of suitable size may be found among the commercially used steel drums for shipping oil, grease, nails, soap, and other products. The most common types, however, lack an adequate sealing device, so a waterproof material should be used around the lid. Fully

removable head drums with lock-ring closures generally give a satisfactory seal.

Glass Jars. The advantage of using glass is that it is waterproof and does not allow chemicals, bacteria and insects to pass through it. Although glass is highly vulnerable to shock, glass jars of a sturdy quality can withstand the crushing pressure normally encountered in caching. However, none of the available glass container have an adequate sealing device for the joint around the lid. The standard commercial canning jar with a spring clamp and a rubber washer is watertight, but the metal clamp is vulnerable to corrosion. Therefore, a glass jar with a spring clamp and a rubber washer is an adequate expedient for short-term caching of small items, but it should not be relied upon to resist moisture for more than a year.

Paint Cans. Standard cans with reusable lids require a waterproof adhesive around the lids. It is especially important to apply several coats of paint to the exterior of standard commercial cans because the metal in these cans is not as heavy as that in metal drums. Even when the exterior is thoroughly painted, paint cans probably will not resist moisture for more than a few months.

Section 3. Methods of Emplacement

Since burial is the most frequently used method of emplacement, this section describes first the complete procedure for burial, followed by a discussion of emplacement procedures peculiar to submersion and concealment. The last area discussed is the preparation of the cache report—a vital part of a caching operation.

BURIAL

When planners have designed a cache and selected the items for caching, they must carefully work out every step of the burial operation in advance. **Horizontal and Vertical Caches**

Ordinarily, the hole for a buried cache is vertical (the hole is dug straight down from the surface). Sometimes a horizontal cache, with the hole dug into the side of a steep hill or bank, provides a workable solution when a suitable site on level or slightly sloping ground is not available. A horizontal cache may provide better drainage in areas of heavy rainfall, but is more likely to be exposed by soil erosion and more difficult to refill and restore to normal appearance.

Dimensions of the Hole

The exact dimensions of the hole, either vertical or horizontal, depend on the size and shape of the cache container. As a general rule, ensures that the hole is large enough for the container to be inserted easily. The horizontal dimensions of the hole should be about 30 centimeters longer and wider than the container. Most importantly, it should be deep enough to permit covering the container with soil to about 45 centimeters. This figure is recommended for normal usage because a more shallow burial risks exposure of the cache through soil erosion or inadvertent uncovering by normal indigenous activity. A deeper hole makes

probing for recovery more difficult and unnecessarily prolongs the time required for burial and recovery.

Excavation Shoring

If there is a risk that the surrounding soil will cave in during excavation, boards or bags filled with subsoil may be used to shore the sides of the hole. Permanent shoring may be needed to protect an improvised container from pressure or shock.

Equipment

The following items of equipment may be helpful or indispensable in burying a cache, depending upon the conditions at the site:

- 1) Measuring instruments (a wire or metal tape and compass) for pinpointing the site.
- 2) Paper and pencil for recording the measurements.
- 3) A probe rod for locating rocks, large roots, or other obstacles in the subsoil. Two ground sheets on which to place sod and loose soil. An article of clothing may be used for small excavation if nothing else is available.
- 4) Sacks (sandbags, flour sacks) for holding subsoil.
- 5) A spade or pickax, if the ground is too hard for spading.
- 6) A hatchet for cutting roots.
- 7) A crowbar for prying rocks.
- 8) A flashlight or lamp if burial is to be done at night.

The Burial Party

Aside from locating, digging, and refilling the hole, the most important factors in this part of the emplacement operation may be expressed with one word: Personnel. Since it is almost impossible to prevent every member of the burial party from knowing the location of the cache, each member is a prime security problem as long as the cache remains intact. Thus, planners must keep the burial party as small as possible and select each member with utmost care. Once selected, each member must have adequate cover to explain his absence from home or work during the operation, his trip to and from the site, and his possession of whatever equipment cannot be concealed on the way.

Transportation for the burial party may be a problem, depending on the number of persons, how far they must go, and what equipment they must take. When planners have worked out all details of the operation, they must brief every member of the burial party on exactly what he is to do from start to finish.

The Operational Schedule

The final step in planning the emplacement operation is to make a schedule to set the date, time, and place for every step of the operation that requires advance coordination. The schedule will depend mainly on the circumstances, but to be

practical it must include a realistic estimate of how long it will take to complete the burial. Here generalizations are worthless, and the only sure guide is actual experience under similar conditions. Planners should consider three things with respect to scheduling. A careful burial job probably will take longer than most novices will expect. Therefore, if circumstances require a tight schedule, a dry run or test exercise before taking the package to the site may be advisable.

Unless the site is exceptionally well concealed or isolated, night burial will be required to avoid detection. Because of the difficulties of working in the dark, a nighttime practice exercise is especially advisable. The schedule should permit waiting for advantageous weather conditions. The difficulties of snow have already been mentioned. Rainy weather increases the problems of digging and complicates the cover story. If the burial is to be done at night, a moonless or a heavy overcast night is desirable.

Site Approach

Regardless of how effective the cover of actions during the trip to the cache site, the immediate approach must be completely unobserved to avoid detection of the burial. To reduce the risk of the party being observed, planners must carefully select the point where the burial party disappears, perhaps by turning off a road into woods. They should as carefully select the reappearance point. In addition, the return trip should be by a different route. The burial party should strictly observe the rule for concealed movement. The party should proceed cautiously and silently along a route that makes the best use of natural concealment. Concealed movement requires foresight, with special attention to using natural concealment while reconnoitering the route and to preventing rattles when preparing the package and contents.

Security Measures at the Site

The burial party must maintain maximum vigilance at the caches site, since detection can be disastrous. The time spent at the site is the most critical. At least one lookout should be on guard constantly. If one man must do the burial by himself, he should pause frequently to look and listen. The burial party should use flashlight or lanterns as little as possible, and should take special care to mask the glare. Planning should include emergency actions in case the burial party is interrupted. The party should be so thoroughly briefed that it will respond instantly to any sign of danger. Planner should also consider the various escape routes and whether the party will attempt to retain the package or conceal it along the escape route .

Steps in Digging and Refilling

Although procedures will vary slightly with the design of the cache, persons involved in caching operations must never overlook certain basic steps. The whole procedure is designed to restore the site to normal as far as possible.

Site Sterilization

When the hole is refilled, make a special effort to ensure that the site is left sterile-restored to normal in every way, with no clues left to indicate burial or the burial party's visit to the vicinity. Since sterilization is most important for the security of the operation, the schedule should allow ample time to complete these final steps in an unhurried, thorough manner. Dispose of any excess soil far enough away from the site to avoid attracting attention to the site. Flushing the excess soil into a stream is the ideal solution. Check all tools and equipment against a checklist to ensure that nothing is left behind. This should include all personnel items that may drop from pockets. To keep this risk to a minimum, members of the burial party should carry nothing on their persons except the essentials for doing the job and covering their actions. Make a final inspection of the site for any traces of the burial. Because this step is more difficult on a dark night, use of a carefully prepared checklist is essential. With a night burial, returning to the site in the daytime to inspect it for telltale evidence may be advisable, if this can be done safely.

SUBMERSION

Emplacing a submerged cache always involves two basic steps: weighting the container to keep it from floating to the surface and mooring it keep it in place.

Container Weighting and Mooring

Ordinarily, container weights rest on the bottom of the lake or river and function as anchors, and the mooring connect the anchors to the container. The moorings must also serve a second function, that is to provide a handle for pulling the cache to the surface when it is recovered. If the moorings are not accessible for recovery, another line must extend from the cache to a fixed, accessible object in the water or on shore.

There are four types of moorings:

1) Spider Web Mooring. The container is attached to several mooring cables that radiate to anchors placed around it to form a web. The container must be buoyant so that it lifts the cables for enough off the bottom to be readily secured by grappling. The site must be located exactly at the time of emplacement by visual sightings to fixed landmarks in the water, or along the shore, using several FRP's to establish a point where two sighted lines intersect. For recovery, the site is located by taking sightings on the reference points, when a mooring cable is engaged by dragging the bottom of diving. This method of mooring is most difficult for recovery. It can be used only where the bottom is smooth and firm enough for dragging, or where the water is not too deep, cold, or murky for diving.

2) Line-to-Shore Mooring. A line is run from the weighted container to an immovable object along the shore. The section of the line that extends from the shore to the shore must be buried in the ground or otherwise well concealed.

3) Buoy Mooring. A line is run from the weighted container to a buoy or

other fixed, floating marker, and fastened well below the waterline. This method is secure only as long as the buoy is left in place. Buoys are generally inspected and repainted every six months or so. The inspection schedule should be determined before a buoy is used.

4) Structural Mooring. A line for retrieving the weighted container is run to a bridge pier or other solid structure in the water. This line must be fastened well below the low-water mark.

Essential Data for Submersion

Whatever method of mooring is used, planners must carefully consider certain data before designing a submerged cache. The cache very likely will be lost if any of the following critical factors are overlooked:

Buoyancy. Many containers are buoyant even when filled, so the container must be weighted sufficiently to submerge it and keep it in place. If the contents do not provide enough weight, emplacers must make up the balance by attaching a weight to the container. The approximate weight needed to attain zero buoyancy is shown in Appendix. This figure applies to several sizes of stainless steel containers. The weighting required for any container can be calculated theoretically if the displacement of the container and the gross weight of the container plus its contents are known. This calculation may be useful for designing an anchor, but it should not be relied upon for actual emplacement. To avoid hurried improvisation during emplacement, emplacers should always test the buoyancy in advance by actually submerging the weighted container. This test determines only that a submerged cache will not float to the surface. Additional weighting may be required to keep it from drifting along the bottom. As a general rule, the additional weight should be at least one-tenth of the gross weight required to make the container sink; more weight is advisable if strong currents are present.

Submersion depth.

Planners must first determine the depth which the container is to be submerged to calculate the water pressure that the container must withstand. The greater the depth, the greater the danger that the container will be crushed by water pressure. For instance, the standard stainless steel burial container will buckle at a depth of approximately 4.3 meters. The difficulty of waterproofing also increases with depth. Thus, the container should not be submerged any deeper than necessary to avoid detection. As a general rule, 2.2 meters is the maximum advisable depth for caching. If seasonal or tidal variations in the water level require deeper submersion, the container should be tested by actual submersion to the maximum depth it must withstand.

Depth of the Water.

Emplacers must measure accurately the depth of the water where at the point where the cache is to be placed. This will be the submersion depth if the cache is designed so that the container rests on the bottom of the lake or river. The container may be suspended some distance above the bottom, but the depth of the water must be known to determine the length of moorings connecting the containers to the anchors.

High-and-Low-Water Marks.

Any tidal or

seasonal changes in the depth of the water should be estimated as accurately as possible. Emplacers must consider the low-water mark to ensure that low water will not leave cache exposed. The high-water point also should be considered to ensure that the increased depth will crush the container or prevent recovery.

Type of Bottom. Emplacers should probe as thoroughly as possible the bed of the lake or river in the vicinity of the cache. If the bottom is soft and silty, the cache may sink into the muck, become covered with sediment, or drift out of place. If the bottom is rocky or covered with debris, the mooring may become snagged. Any of these conditions may make recovery very difficult.

Water Motion. Emplacers should consider tides, currents, and waves because any water motion will put additional strain on the moorings of the cache. Moorings must be strong enough to withstand the greatest possible strain. If the water motion tends to rock the cache, emplacers must take special care to prevent the moorings from rubbing and fraying.

Clearness of the Water. When deciding how deep to submerge the cache, emplacers must first determine how far the cache can be seen through the water. If the water is clear, the cache may need to be camouflaged by painting the container to match the bottom. (Always paint shiny metallic fixtures a dull color.) Very murky water makes recovery by divers more difficult.

Water Temperature. Planners must consider seasonal changes in the temperature of the water. Recovery may be impossible in the winter if the water freezes. The dates when the lake or river usually freezes and thaws should be determined as accurately as possible.

Salt Water. Since seawater is much more corrosive than fresh water, tidal estuaries and lagoons should not be used for caching. The only exception is the maritime re-supply operation, where equipment may be submerged temporarily along the seacoast until it can be recovered by a shore party.

CONCEALMENT

There are many different ways to conceal a cache in natural or ready-made hiding places. For instance, if a caching party were hiding weapons and ammunition in a cave, relying entirely on natural concealment, the emplacement operation would be reduced to simply locating the site. No tools would be needed except paper, pencil and a flashlight. On the other hand, if the party were sealing a packet of jewels in a brick wall, a skilled mason would be needed, his kit of tools, and a supply of mortar expertly mixed to match the original brick wall. When planning for concealment, planners must know the local residents and their customs. During the actual emplacement, the caching party must ensure the operation is not observed. The final sterilization of the site is especially important, since a concealment site is usually open to frequent observation.

CACHING COMMUNICATIONS EQUIPMENT

As a general rule, all equipment for a particular purpose (demolitions, survival) should be included in one container. Some equipment, however, is so sensitive

from a security standpoint that it should be packed in several containers and cached in different locations to minimize the danger of discovery by the enemy. This is particularly true of communications equipment, since under some circumstances anyone who acquires a whole RT set with a signal plan and cryptographic material would be able to play the set back. An especially dangerous type of penetration would result.

In the face of this danger, the signal plan and the cryptographic material must never be placed in the same container. Ideally a communications kit should be distributed among three containers and cached in different locations. If three containers are used , the distribution may be as follows:

- 1) Container #1: The RT set, including the crystals.
- 2) Container #2: The signal plan and operational supplies for the RT operator, such as currency, barter and small arms.
- 3) Container #3: The cryptographic material.

When several containers are used for one set of equipment, they must be placed far enough apart so that if one is discovered, the others will not be detected in the immediate vicinity. On the other hand, they should be located close enough together so that they can be recovered conveniently in one operation. The distance between containers will depend on the particular situation, but ordinarily they should be at least 10 meters apart. One final reference point ordinarily is used for a multiple cache. The caching party should be careful to avoid placing multiple caches in a repeated pattern. Discovery of one multiple cache would give the opposition a guide for probing others placed in a similar pattern.

CACHING MEDICAL EQUIPMENT

A feasibility study must be performed to determine the need for the caching of medical supplies. The purpose of caches is to store excess medical supplies, to maintain mobility, and deny access to the enemy. Also caching large stockpiles of medical supplies allows prepositioning vital supplies in anticipation of future planned operations.

THE CACHE REPORT

The final step, which is vital in every emplacement operation, is the preparation of a cache report. This report records the essential data for recovery. The cache report must provide all of the information that someone unfamiliar with the locality needs to find his way to the site, recover the cache, and return safely. The report format follows.

THE TWELVE-POINT CACHE REPORT

- 1) Type of Cache
- 2) Method of Caching
- 3) Contents
- 4) Description of Containers
- 5) General Area

- 6) Immediate Area
- 7) Cache Location
- 8) Emplacement Details
- 9) Operational Data and Remarks
- 10) Dates of Emplacement and Duration of the Cache
- 11) Sketches and Diagrams
- 12) Radio Message for Recovery Content

The most important parts of the cache report must include instructions for finding and recovering the cache. It should also include any other information that will ease planning the recover operation. Since the details will depend upon the situation and the particular needs of each organization, the exact format of the report cannot be prescribed. The Twelve-Point cache Report is intended merely to point out the minimum essential data. Whatever format is used, the importance of attention to detail cannot be overemphasized. A careless error or omission in the cache report may prevent recovery of the cache when it is needed.

Procedure

The observer should collect as much data as possible during the personal reconnaissance to assist in selecting a site and planning emplacement and recovery operations. Drafting the cache report before emplacement is also advisable. Following these procedures will reveal the omissions. Then the missing data can be obtained at the site. If this procedure is followed, the preparation of the final cache report will be reduced to an after-action check. This check ensures that the cache actually was placed precisely where planned and that all other descriptive details are accurate. Although this ideal may seldom be realized, two procedures always should be followed:

- 1) The caching party should complete the final cache report as soon as possible after emplacement, as details are fresh in mind.
- 2) Someone who has not visited the site should check the instructions by using them to lead the party to the site. When such a person is available, they should visit the site shortly after emplacement, provided he can do so securely. If the cache has been embraced at night, a visit to the site in daylight may also provide an opportunity to check on the sterilization of the site.

Temporary Concealment Spots

The DEA Stash and Hideout Handbook was obtained via covert means from the U.S. Drug Enforcement Administration. This information has been classified "Top Secret -- Eyes Only" for DEA officers, and is information the DEA uses.

This is the actual list used in seminars conducted to train narcotics officers in search and seizure of drugs and contraband items. These seminars instruct many military, state, local, and foreign narcotics officers. The places listed here are not checked in every search, nor are these the only places searched.

CONCEALMENT IN THE HOME

- Under or in the mailbox
- In flower pots and window boxes
- Inside hollow doors (removable tops)
- Inside door chimes and door bell
- Behind plumbing inspection doors
- In doorknobs
- Under or in dog collars
- Hanging out windows
- In rolled-up window shades
- On or under window ledge next door
- On top of window, door sills, moldings
- In fire and water hoses
- In or on cellar beams
- Taped to movable clothesline
- Behind exterior brick near window
- Inside fuse boxes
- In conduit from fuse box
- Inside fire alarm bell
- In dog houses
- In rain gutters and drain spouts
- Inside abandoned plumbing
- In attic insulation
- Inside or under furnace
- In hollowed-out tree
- Within fuel of oil heaters
- Under lip ring of plastic trash cans
- Under tile steps of backyard
- Under fence post tops
- Inside rabbit hutch
- In pay telephone coin return
- In telephone base and handle
- Behind wall phones
- Under telephone name plate
- In clothesline pipe
 - Refrigerator:
 - Inside fruit containers
 - In eggs
 - Inside mayonnaise
 - Under food
 - Taped under door
 - Inside motor compartment
 - On food items
- Inside garbage disposal unit

- Behind electric baseboard heaters
- Inside string mop
- Under ironing board cover
- On bottom of dog food bag
- Bottom half of double boiler
- In ironing board legs
- Under toaster tray
- Inside plastic rolling pin
- Inside knife handles
- In clock
- In hot-air ducts
- In stove pipes
- In garbage bags
- In bromo seltzer, cough syrup, prescription drug bottles
- In baked bread, cookies, brownies, and candy bars
- Built inside room dividers
- Behind kick plates of sink cabinets
- In stove insulation, exhausts, and drip pans
- Within tea bags
- Above acoustic tile ceilings
- Inside tinfoil tube
- Inside paper towel tube
- In salt and pepper shakers
- In waxed-paper dispensers
- In spice jars
- In all kitchen canisters and containers
- In hollowed fruits and vegetables
- In or on chandelier
- Within agitator of clothes washer
- On, behind, or above Venetian blinds
- In fluorescent light tubes
- Behind wall and ceiling light fixtures
- Inside light housing
- Behind light switches
- Inside or behind electric sockets
- In removable air-conditioning registers
- In range hood and filter
- Inside deep well fryers
- Behind baseboards
- Inside flashlights
- Inside douche bags
- Within sanitary napkins and in box

- In razor blade dispenser
- In hollowed-out flashlight batteries
- Inside talcum powder, cold cream, and Vaseline containers
- In electric toothbrush holder
- In toothpaste tubes
- In clothes hamper
- Hung behind curtains
- Inside false ceilings and chimneys
- In or behind sink traps
- In bases of lamps
- Under washbowl, sink, or tub
- At bottom of pet litter box
- Inside hollow curtain rods, shower curtain rods, and within closet rods
- Under false bottom on radiator covers
- Inside toilet tanks
- Inside toilet bowl float
- Taped to top of toilet bowl
- Within false aerosol cans
- In Band-aids and Band-Aid boxes
- Inside stick deodorant containers
- Within hollow soap bars
- Under panel or parquet floors
- Inside toilet paper roll
- In clothes-pin bag
- Inside hollow handle of toilet bowl brush
- In after shave, cologne, or cosmetic bottles
- Behind and inside medicine cabinets
- Inside shaving brush handles
- In hair dryer
- In shower nozzle head
- In razor blade disposal box
- In or behind legs of old-style bath tub
 - Closet clothing:
 - In waistbands
 - in pens
 - In sleeves
 - In hat bands
 - In shoes
 - In gloves
- Behind picture frames, posters, and mirrors
- In mattresses and box spring frames
- Inside pillows
- Under carpets

- In seams of field cots and hollow cap of cot legs
- Inside hassocks
- Inside and under wigs
- Behind walls
- In hollow bedposts
- In furniture upholstery
- In golf bags
- In toys, stuffed animals, and games
- Inside child's bank
- Taped in dresser and behind drawers
- Inside concealed magnet boxes
- Inside zippered cushions
- Inside pipe rack stand
- In false-bottomed baby carriage and cribs
- In footlockers
- In hem of drapes and curtains
- In hidden drawers in tables
- Inside letters
- In dolls
- In art kits
- Bible (hollow cover) and other books (hollow pages)
- Inside jewelry boxes
- Mixed with tobacco
- Taped to hat or shoe boxes
- Inside tube and barrel of air rifle
- In bird cage
- In typewriters and typewriter covers
- Inside hollow chess players and boards
- Inside hollow canes and umbrellas
- In fireplace ash clean-out bin
- Inside base of rabbit antenna
- Inside TV set
- Inside TV antenna
- Inside altered picture tube or other components
- Within hollowed-out pad of paper
- In surf boards, skis and other sports equipment
- Inside Christmas tree decorations
- Inside handle of vacuum cleaners
- Inside and behind vacuum cleaner bag
- In tool box
- In shoe polish container and equipment
- In 35 mm film cans

- Inside cameras
- In record albums
- In fish tanks
- Inside patch trap of antique rifle
- Inside rifle cartridges and shotgun shells
- Behind rifle butt plates
- Inside carpenter's toolbox
- Inside candlestick holders
- Inside ceramic and clay figurines
- Inside rolled-up newspaper
- Inside trophies
- In test tubes
- Inside crucifix
- Inside sealed and opened cigarette packages
- Inside stairway posts
- Inside transistor radio
- Inside speakers
- Inside other stereo components
- In musical instruments and cases

CONCEALMENT IN AN AUTOMOBILE

- Inside horn
- In air filter
- In false heater hose
- In heater
- In false battery
- In oil filter
- In windshield washer bag
- In carburetor
- Inside oil cap
- In false dual muffler
- In hollow voltage regulator
- On top of gas tank (suspended or concealed in compartment)
- In 35 mm film cans
- Under rocker panels
- Tied to axle
- Underside of fender
- In tail pipe
- In insulation under hood
- Under chrome
- Behind Volkswagen battery box
- Inside trunk lids
- Inside tubing on roof racks

- Inside tubing on surfboard or ski rack
- Under tire air valve caps
- Taped behind bumper
- In antenna base
- Taped to rolled-down window
- Behind license plates
- Attached to frame of car
- Behind headlights and taillights
- Within hub caps
- In picnic jug in trunk
- In double roof of surplus police cars
- Within spare tire and tire well
- In convertible top
- In trunk
- In fuse box
- Under false bottom of trunk beds
- In cigarette lighter
- Under floorboards
- Under front seat
- Under back seat
- Within vents (air and heater)
- In glove compartment -- top of compartment or trap
- Within door
- Behind radio speaker grill
- In shift knob
- In steering column
- In dome light
- In and under ashtrays
- Inside key case
- In service station travel kits
- Under brake and gas pedals
- In or behind sun visors
- Under carpet
- Behind or within false radio
- Inside a hide-a-key container
- Pill vials
- Under floor mats
- Within upholstery
- Behind instrumental panel
- Under ornamental objects on dashboard
- Within compartments under floor of older VWs and Jeeps
- Inside floor consoles

- Inside dash knobs
- Within arm rests
- Inside flashlight
- Inside toolbox
- Inside light sockets

CONCEALMENT ON A MOTORCYCLE

- Behind taillights
- Under seats
- Inside handlebar tubing
- Inside battery box
- In toolbox
- Rolled up inside sleeping bag or other carried items
- Concealed compartment in custom gas tank
- Inside lining of motorcycle helmet
- In concealed pockets in padded clothing
- Behind headlight
- Behind instrument gauges
- Inside tires

CONCEALMENT ON THE PERSON

- Inside false caps on teeth
- Swallowed with string tied to teeth
- Under false teeth
- Loose in mouth
- Behind or in ears
- In glass eyes
- In nose
- Taped under breasts
- In brassiere
- Under Band-aids and bandages
- Within rectum
- Within vagina
- Between cheeks of buttocks
- Under foreskin of penis
- Inside feces bag
- In false leg, arm, foot, etc.
- In or behind womens' hair barrettes
- Under processed hair, hair buns, or wigs
- In hearing aids mounted on eyeglasses or within ears
- In earrings
- In rings
- Inside neck and wrist locket, bracelets, and charms
- Inside ID bracelets

- In plaster or plastic casts
- Under hat bands
- In hats
- Under military cap insignia
- Under lapel and shoulder patches
- Behind campaign ribbons and uniform brass
- In love beads
- In fountain pens
- In money belts, slit or zippered
- In tie pins, clasps, and cuff links
- In lining of clothing
- Within false buttons
- Under lapels of jacket and coats
- Inside back of watch
- In pockets
- In eyeglass case
- In corsets
- In tie knot of tie and handkerchiefs
- Jockstraps
- Wallet
- In hollow belt buckles
- Inside fly flap of trousers
- Pinned to shorts
- In swimming trunks
- In male or female girdle
- Inside cuffs and waistbands
- In socks and shoes
- In baby's diapers
- In lipstick tube
- In tobacco tins and pouches
- In cigarette package
- In cigarette lighters
- Inside hollowed-out crutches
- In hollow end of cane or umbrella
- In Thermos jug cavity or lining
- In canteens
- In addressed envelopes
- Within liners of luggage

V. Operational Security (OPSEC)

Introduction to OPSEC: A Caution Against Paranoia

For a detailed guide on this topic see Sam Culper's Security A Resistance Manual:
<https://archive.org/details/SamCulperSecurityAResistanceManual>

The following summary of the modern state of the surveillance network is provided to make the reader aware of one thing:

PERFECT OPSEC IS AN ILLUSION. THE ONLY PATH TO VICTORY IS THROUGH DETERMINED ACTION AND MILITARY PROWESS.

It is highly encouraged to assign certain people within your combat unit the role of maintaining OPSEC/INFOSEC and developing this understanding among the rest, not through constant discussion, but through timely updates, should their behaviors deviate from agreed upon procedures. Ultimately, the modern revolutionary must be agile and aware, this Appendix is a collection of modern tools to supplement a strident behavioral style. A sufficient degree of OPSEC to provide reassurance and guide actions is to be weighted against paranoia and inaction. **Ultimately, it is preferential to discount OPSEC in favor of revolutionary action and a coherent understanding of National Socialist principles, especially as they apply to continuous improvement.** In practice this means: „Keep Calm and Carry On“!

Note: Burner phones, Signal Jammers and EM weapons are not discussed however are recommended for further personal study. Burner phones (both old and new) especially present an attractive option for revolutionaries with access to expansive financial options, and are ideal for communications.



TOR

As a very long time Tor user, the most surprising part of the NSA documents was how little progress they have made against Tor. Despite its known weaknesses, it's still the best thing we have, provided it's used properly and you make no mistakes.

If seeking security of "the greatest degree technically feasible" such as when facing ZOG or an enemy well-funded government with significant visibility or control of the Internet you must take into consideration the warnings that Tor is not sufficient to protect you from such an actor.

Consider whether you truly need this level of protection. If having your activity discovered does not put your life or liberty at risk, then you probably do not need to go to all of this trouble. But if it does, then you absolutely must be vigilant if you wish to remain alive and free.

Contents

- 1) Your Computer
- 2) Your Environment
- 3) Your Mindset
- 4) Hidden Services
- 5) Conclusion
- 6) Source

1) Your Computer

To date, the NSA and FBI's primary attacks on Tor users have been Man-in-the-middle (MITM) attacks (NSA) and hidden service web server compromises (FBI) which either sent tracking data to the Tor user's computer, compromised it, or both. Thus, you need a reasonably secure system from which you can use Tor and reduce your risk of being tracked or compromised.

1) **Don't use Windows.** Just don't. This also means don't use the Tor Browser Bundle on Windows. Vulnerabilities in the software in Tor browser button figure prominently in both the NSA slides and FBI's recent takedown of Freedom Hosting.

2) If you can't construct your own workstation capable of running Linux and carefully configured to run the latest available versions of Tor, a proxy such as Privoxy, and a web browser (with all outgoing clearnet access firewalled), consider using Tails or Whonix instead, where most of this work is done for you. It's absolutely critical that outgoing access be firewalled, so that third party applications cannot accidentally leak data about your location.

3) If you are using persistent storage of any kind, ensure that it is encrypted. Current versions of LUKS are reasonably safe, and major Linux distributions will offer to set it up for you during their installation. TrueCrypt might be safe, though it's not nearly as well-integrated into the OS. BitLocker might be safe as well, though you still shouldn't be running Windows. Even if you are in a country where rubber hosing is legal, such as the UK, encrypting your data protects you from a variety of other threats.

4) Remember that your computer must be **kept up to date**. Whether you use Tails or build your own workstation from scratch or with Whonix, update frequently to ensure you are protected from the latest security vulnerabilities. Ideally, you should update each time you begin a session, or at least daily. Tails will notify you at startup if an update is available.

5) Be very reluctant to compromise on JavaScript, Flash and Java. Disable them all by default. If a site requires any of these, visit somewhere else. Enable scripting only as a last resort, only temporarily, and only to the minimum extent necessary to gain functionality of a web site that you have no alternative for.

6) Viciously drop **cookies and local data** that sites send you. Neither the Tor browser button nor Tails do this well enough for my tastes; consider using an addon such as Self-Destructing Cookies to keep your cookies to a minimum (0).

7) Your workstation should be a **laptop**; it must be portable enough to be carried with you and quickly disposed of or destroyed.

8) Don't use **Google** to search the Internet. A good alternative is Startpage; this is the default search engine for Tor browser button, Tails, and Whonix. Another is DuckDuckGo which also has a hidden service. Plus, it won't call you malicious or ask you to fill out CAPTCHAs.

2) Your Environment

Tor contains weaknesses which can only be mitigated through actions in the physical world. An attacker who can view both your local Internet connection, and the connection of the site you are visiting, can use statistical analysis to correlate them.

1) Never use Tor from home, or near home. Never work on anything sensitive enough to require Tor from home, even if you remain offline. Computers have a funny habit of liking to be connected. This also applies to anywhere you are staying temporarily, such as a hotel. Never performing these activities at home helps to ensure that they cannot be tied to those locations. (Note that this applies to people facing advanced persistent threats. Running Tor from home is reasonable and useful for others, especially people who aren't doing anything themselves but wish to help by running an exit node, relay, or bridge.

2) Limit the amount of time you spend using Tor at any single location. While these correlation attacks do take some time, they can in theory be completed in as little as a day. And while the enemy are very unlikely to show up the same day you fire up Tor at Starbucks, they might show up the next day. I recommend for the truly concerned to never use Tor more than 24 hours at any single physical location; after that, consider it burned and go elsewhere. This will help you even if the enemy show up six months later; it's much easier to remember a regular customer than someone who showed up one day and never came back. This does mean you will have to travel farther afield, especially if you don't live in a large city, but it will help to preserve your ability to travel freely.

3) When you go out to perform these activities, leave your cell phone turned on and at home.

3) Your Mindset

Many Tor users get caught because they made a mistake, such as posting their real E-mail address in association with their activities. You must avoid this as much as possible, and the only way to do so is with careful mental discipline.

1) Think of your Tor activity as pseudonymous, and create in your mind a virtual identity to correspond with the activity. This virtual person does not know you and will never meet you, and wouldn't even like you if he knew you. He must be kept strictly mentally separated.

2) If you must use public Internet services, create completely new accounts for this pseudonym. Never mix them; for instance do not browse Facebook with your real E-mail address after having used Twitter with your pseudonym's E-mail on the same computer. Wait until you get home.

3) By the same token, never perform actions related to your pseudonymous activity via the clearnet, unless you have no other choice (e.g. to sign up for a provider who blocks Tor), and take extra precautions regarding your location when doing so.

4) If you need to make and receive phone calls, purchase an anonymous prepaid phone for the purpose. This is difficult in some countries, but it can be done if you are creative enough. Pay cash; never use a debit or credit card to buy the phone or top-ups. Never insert its battery or turn it on if you are within 10 miles (16 km) of your home, nor use a phone from which the battery cannot be removed. Never place a SIM card previously used in one phone into another phone. Never give its number or even admit its existence to anyone who knows you by your real identity. This may need to include your family members.

4) Hidden Services

These are big in the news lately, with the recent takedown of at least two high-profile hidden services, Silk Road and Freedom Hosting. The bad news is, hidden services are much weaker than they could or should be. The good news is, the NSA doesn't seem to have done much with them (though the NSA slides mention a GCHQ program named ONIONBREATH which focuses on hidden services, nothing else is yet known about it)¹.

In addition, since hidden services must often run under someone else's physical control, they are vulnerable to being compromised via that other party. Thus, it's even more important to protect the anonymity of the service, as once it is compromised in this manner, it's pretty much game over.

The advice given above is sufficient if you are merely visiting a hidden service. If you need to run a hidden service, do all of the above, and in addition do the following. Note that these tasks require an experienced system administrator; performing them without the relevant experience will be difficult or impossible.

1 Verify the most current state of intelligence on any enemy intelligence network

1) Do not run a hidden service in a virtual machine unless you also control the physical host. Designs in which Tor and a service run in firewalled virtual machines on a firewalled physical host are OK, provided it is the physical host which you are in control of, and you are not merely leasing cloud space.

2) A better design for a Tor hidden service consists of two physical hosts, leased from two different providers though they may be in the same datacenter. On the first physical host, a single virtual machine runs with Tor. Both the host and VM are firewalled to prevent outgoing traffic other than Tor traffic and traffic to the second physical host. The second physical host will then contain a VM with the actual hidden service. Again, these will be firewalled in both directions. The connection between them should be secured with IPSec, OpenVPN, etc. If it is suspected that the host running Tor may be compromised, the service on the second server may be immediately moved (by copying the virtual machine image) and both servers decommissioned. Both of these designs can be implemented fairly easily with Whonix.

3) Hosts leased from third parties are convenient but especially vulnerable to attacks where the service provider takes a copy of the hard drives. If the server is virtual, or it is physical but uses RAID storage, this can be done without taking the server offline. Again, do not lease cloud space, and carefully monitor the hardware of the physical host. If the RAIDarray shows as degraded, or if the server is inexplicably down for more than a few moments, the server should be considered compromised, since there is no way to distinguish between a simple hardware failure and a compromise of this nature.

4) Ensure that your hosting provider offers 24x7 access to a remote console (in the hosting industry this is often called a KVM though it's usually implemented via IPMI which can also install the operating system). Use temporary passwords/passphrases during the installation, and change them all after you have Tor up and running (see below). The remote console also allows you to run a fully encrypted physical host, reducing the risk of data loss through physical compromise; however, in this case the passphrase must be changed every time the system is booted (even this does not mitigate all possible attacks, but it does buy you time).

5) Your initial setup of the hosts which will run the service must be over clearnet, albeit via SSH; however, to reiterate, they must not be done from home or from a location you have ever visited before. As we have seen, it is not sufficient to simply use a VPN. This may cause you issues with actually signing up for the service due to fraud protection that such providers may use. How to deal with this is outside the scope of this answer, though.

6) Once you have Tor up and running, never connect to any of the servers or virtual machines via clearnet again. Configure hidden services which connect via SSH to each host and each of the virtual machines, and always use them. If you must connect via clearnet to resolve a problem, again, do so from a location you will never visit again.

7) Hidden services must be moved regularly, even if compromise is not suspected. A 2013 paper described an attack which can locate a hidden service in just a few months for around \$10,000 in cloud compute charges, which is well within the budget of even some individuals. It is safer, though not at all convenient, to move the hidden service at least monthly. Ideally, it should be moved as frequently as possible, though this quickly veers into the impractical. Note that it will take approximately an hour for the Tor network to recognize the new location of a moved hidden service.

5) Conclusion

Anonymity is hard. Technology alone, no matter how good it is, will never be enough. It requires a clear mind and careful attention to detail, as well as real-world actions to mitigate weaknesses that cannot be addressed through technology alone. As has been so frequently mentioned, the attackers can be bumbling fools who only have sheer luck to rely on, but you only have to make one mistake to be ruined. We call them "advanced persistent threats" because, in part, they are persistent. They won't give up, and you must not.

<https://www.torproject.org/download/download-easy.html#warning>

TOR + VPN and Advanced Considerations

If you wish to proceed past this point you will need to have a deep understanding of exactly what a VPN is and how internet connections operate on a fundamental level. If any of the terminology used before confuses you then find somebody more competent to interpret the following section.

Now for those who are still reading, Stallman may be some goony beard guy who supports some commie BS and is constantly crying about Trump but his website's pretty decent to dig through for info. His long term link is a good place to dig for sites that may house some decent info: <https://stallman.org/longterm.html>

1) Assorted Topics and Considerations

i) „I've got nothing to hide!“

'I've Got Nothing to Hide' and Other Misunderstandings of Privacy

https://papers.ssrn.com/sol3/papers.cfm?abstract_id=998565&

Why Privacy Matters - Ted Talk

https://www.ted.com/talks/glenn_greenwald_why_privacy_matters

Prism break - <https://prism-break.org/>

Additionally, this is old information, but still relevant: Hacker OPSEC -

<http://grugq.github.io/>

Infosec news and resources - <http://infosecisland.com>

Forum for carding (but also great resource for OPSEC) - <https://prtship.com>

ii) „What about TOR+VPN or TOR+proxies, is it worse than plain TOR?“

It can provide a benefit in certain circumstances.

You-to-Tor-to-VPN-to-clearnet will let you use sites that block Tor exits (unless they also block your vpn provider). You-to-VPN-to-Tor will prevent anyone observing your local traffic from knowing that you are connecting to the Tor network (though obviously they will know you are connecting to the VPN)
Source: <https://trac.torproject.org/projects/tor/wiki/doc/TorPlusVPN>

You -> VPN/SSH -> Tor

You can route Tor through VPN/SSH services. That might prevent your ISP etc from seeing that you're using Tor (VPN/SSH Fingerprinting below). On one hand, VPNs are more popular than Tor, so you won't stand out as much, on the other hand, in some countries replacing an encrypted Tor connection with an encrypted VPN or SSH connection, will be suspicious as well. SSH tunnels are not so popular.

Once the VPN client has connected, the VPN tunnel will be the machine's default Internet connection, and TBB (Tor Browser Bundle) (or Tor client) will route through it.

This can be a fine idea, assuming your VPN/SSH provider's network is in fact sufficiently safer than your own network.

Another advantage here is that it prevents Tor from seeing who you are behind the VPN/SSH. So if somebody does manage to break Tor and learn the IP address your traffic is coming from, but your VPN/SSH was actually following through on their promises (they won't watch, they won't remember, and they will somehow magically make it so nobody else is watching either), then you'll be better off.

You -> Tor -> VPN/SSH

You can also route VPN/SSH services through Tor. That hides and secures your Internet activity from Tor exit nodes. Although you are exposed to VPN/SSH exit nodes, you at least get to choose them. If you're using VPN/SSHs in this way, you'll want to pay for them anonymously (cash in the mail [WARNING: Your printer may leave identifying microdots on the page. Research if your printer leaves microdots.], Liberty Reserve, well-laundered Bitcoin, etc).

However, you can't readily do this without using virtual machines. And you'll need to use TCP mode for the VPNs (to route through Tor). In our experience, establishing VPN connections through Tor is chancy, and requires much tweaking. Even if you pay for them anonymously, you're making a bottleneck where all your traffic goes – the VPN/SSH can build a profile of everything you do, and over time that will probably be really dangerous.

VPN/SSH Fingerprinting

Using a VPN or SSH does not provide strong guarantees of hiding your the fact you are using Tor from your ISP. VPN's and SSH's are vulnerable to an attack called Website traffic fingerprinting

1) Very briefly, it's a passive eavesdropping attack, although the adversary only watches encrypted traffic from the VPN or SSH, the adversary can still guess

what website is being visited, because all websites have specific traffic patterns. The content of the transmission is still hidden, but to which website one connects to isn't secret anymore. There are multiple research papers on that topic (See footnote).

2) Once the premise is accepted, that VPN's and SSH's can leak which website one is visiting with a high accuracy, it's not difficult to imagine, that also encrypted Tor traffic hidden by a VPN's or SSH's could be classified. There are no research papers on that topic. Examining research papers on related topics is a must for SS members in charge of INFOSEC and/or OPSEC.

What about Proxy Fingerprinting? It has been said above already, that connections to proxies are not encrypted, therefore this attack isn't even required against proxies, since proxies cannot hide the fact that you're using Tor anyway.

iii) Chain VPNs and Metadata:

Unlike what is often wrongly assumed, metadata is extremely powerful, and chaining multiple VPNs or using simply a VPN or Tor is not that safe. The following may allow you to better evade detection via Metadata:

<https://security.stackexchange.com/questions/121733/how-can-meta-data-be-used-to-identify-users-through-chained-vpns/121738#121738>

2) Best Linux distro

Due to constant debate and fanboyism regarding various distributions of the Linux OS no one version is to be entirely recommended, though Ubuntu or Mint are best in my opinion. The user is asked to look at the features of each distribution and the intention behind using it and hardware it will be booted on. You can dual boot most Linux distributions or live boot them from a USB or CD/DVD.

3) Carding/Fraud OPSEC

Whether or not you are looking to commit fraud (perhaps you require money for supplies) here is a guide for carding OPSEC which works very well for general guerrilla OPSEC.

As a fraudster, the first thing you need to have done, is your Opsec (Operational Security). If you live and do fraud in high risk countries such as USA, Canada, UK, then your Opsec must be rock solid.

If you live in Africa, India and other low risk countries, in that case OPSEC matters less. The good thing of fraud is that if you have decent opsec, you will never worry about ending up in jail, unlike selling drugs etc. The opsec that I give here is simple yet extremely effective. Follow it to the line and you will be safe, rest assured.

Hardware

You will require a burner laptop, avoid at all costs desktop pcs, as you can't bring them with you, plus if there is a raid going on from LE, you will find it

harder to get rid of it/hide it. Here are the general specs that you will need to work proficiently: a minimum of a 8GB RAM and I5 processor laptop will be enough to handle all the apps and processes running into the VM.

Don't include any of your personal information here. Another thing you will need is a burner smartphone. I highly recommend an android one, as iOS is far too limited. You might need this one when you will do mobile carding, although you can execute mobile carding even from your laptop.

USB

Stick key: Make sure it has plenty of gigabytes, you will store all your portable applications and some of the illegal data here. In case you are in troubles, you can throw away/ destroy it and all the evidence will be gone. Now, where to execute your fraud activities? I hear non-sense on forum such as going to the public library, use their wi-fi, go to an internet cafe and use their internet. Avoid at all costs public places. It doesn't look good that you browse some onion site and/or a clearnet cc autoshop. Long story short, make sure you are in a place where no one can spy on you.

Software

Now that you have a laptop, you need to install the software, first of all, you will install VMware or VirtualBox. They both basically serve the same purpose, however VMware is not free, therefore it runs a little bit smoother, however I would suggest avoid buying legit licenses, or using licenses that you get at university/work etc. You can find it free on the internet too if you dig deep enough, but personally I use VirtualBox since it's free and as I said, serves literally the same purpose. Anyways, it is up for you to decide on this one.

After installing VMware or VirtualBox, proceed and create a virtual machine, and install an operating system on that. I would suggest using Windows7, since believe it or not, majority of the computers are still running. In addition, getting a copy of win7 is pretty easy and you can find activation keys all over the internet. Make sure to give plenty of space for windows VM, since it takes a bunch of space, and the more space you give the better it will run (given the fact that your pc is not a potato).

Now Install the following softwares on the machine: Mozilla Firefox (regular browsing), Mozilla Thunderbird (email management) Tor browser, ICQ(messaging) Team Viewer, Viscosity (DNS leak prevention) Cleaner (system cleaner) Bleachbit (additional cleaner) Mozbackup (Profile saver for FFox). These are the basics that you will most likely need with whatever method you will use(except mobile emulator setups). AND VERY IMPORTANT PART FOR CARDING. GET Yourself a LINKEN SPHERE browser, since nowadays it is the most reliable browser for carding. Not many people know this but even AD 7.4 is trashed now for like 4 months and it leaks data that indicates that you are not who you are claiming to be. As a result, you will burn many cards and will struggle a lot with carding, however LINKEN SPHERE covers all your tracks and does not leak anything.

Encryption:

Ok let's touch a fundamental topic about security, encryption. Here's the bad news, encryption won't always hide 100% your illegal files, as a matter of fact many

fraudsters get caught and the evidence extracted, but I still highly suggest to encrypt your illegal data. You can use Veracrypt to encrypt your virtual machine. I strongly suggest to encrypt your Virtual machines. You can look it up on youtube, however it is not an easy task if you don't have a clue what you're doing.

VPN

Now, you also need to install a good VPN. It stands for Virtual Private Network, it will aid in hiding your real IP and keep you protected online. A good VPN must pass this checklist:

- 1) Does not store logs: this is important as if they store your IP and Law Enforcement demands for it, you are practically screwed
- 2) Non- Usa one: American VPNS are forced to give logs if LE asks for it by law hence avoid VPNs from USA even if they claim they do not keep logs
- 3) Fast: Virtual carding is slow itself when you add a VPN and socks, so make sure your VPN is blazing fast and pick a server that is closest to your location
- 4) Has a killswitch: Let's assume the connection from vpn server drops, your real IP is practically naked! (except if you are under a socks5, but LE can still do a traceback and find you), so your VPN provide must have a killswitch feature that kills your App if that happens.
- 5) DNS leak protection: This can be annoying so make sure your VPN provider helps you with that
- 6) Payment by BTC allowed: Of course you want to keep yourself anonymous even by payment method wise, so make sure the VPN accepts BTC
- 7) Auto login and connect and start up: It's annoying to always launch the VPN and connect it by yourself, so make sure your VPN allows you to connect and login on windows start.

Luckily boys, I'm here for you and I suggest using Mullvad, since it is probably the most reliable VPN on the market and passes this checklist. It costs like 7\$ a month and is fairly simple to use. After your illegal operations, you have to clear all your traces from both your host and Virtual Machine. We do so by running CCleaner and Bleachbit. You have to check all the checkboxes, ensuring that all the traces in your computer will be removed, don't check wipe free space or it's going to take too long. Also, you have to use the 35 Gutmann steps cleaning, ensuring that the files will be permanently deleted.

In the options of Ccleaner make sure to check "secure file deletion box" and very complex overwrite (35 passes) is chosen.

Final words on security: Yes, being safe is important, but don't push it too far, there's a mental disease that I call opsec paranoia, as if their security setup is never enough, I also learned that the more security you add the more frustrating fraud gets, in fact I've seen some fraudsters with double kill switched VPN. One is more than enough. Remember that there's always a small risk that you get caught. From my experience, a burner laptop with encrypted illegal data and a kill switched VPN is more than enough to keep you safe without too many hassles, also make sure your key apps like browser etc are killswitched, many forget about this (don't need to

do that on Mullvad, since it blocks the internet connection on default killswitch settings).

SPOOFING

All the websites you are trying to card can read plenty of information about your fingerprinting. The browser fingerprint will be used to identify us and also used as possible evidence against us (in case they have our real IP and other sensitive data). And if they find something phishy, most likely they will put your fraudulent order on review or simply decline it. The secret here is to look like the average guy, and spoof as many details of the victim. Remember that the greatest skill of a fraudster is to look as genuine possible if not more genuine than a legit customer. If you go on whoer.net, you will see that it's able to read many things about you. Contrary to widespread belief, having 100% score on whoer is totally bad, that's an anonymity score, not a spoofing score, and generally speaking when you want to be anonymous, you have to hide stuff. Another good one is browserleaks.com, when you check your spoofing setup you have to check on both of them. I'm going to give you an ideal fingerprint that has high success rate for desktop based carding:

Do Not Track(DNT): DNT is a HTTP header that allows the user to avoid tracking his or her actions by third party websites. When you work online, all your actions are saved in your browser cache: visited URLs, search queries, purchases you made in stores, etc. All this data can be read by websites and then used for marketing or analysis purposes. For example, a user typed "buy a bike." This query is saved in his or her browser cache and is now available for third parties to view. From now on, this user will be able to see bike ads all across the Internet. Do Not disable this like whoer recommends, no legit user deactivates DNT. CCleaner/bleachbit are enough to delete that fingerprint.

OS: You will want to spoof your OS as win7. why? Because win7 is the most widespread one at the moment

User Agent: I recommend to spoof Chrome, as it's the most widespread browser, always try to use the most recent browser version. Source http://www.w3schools.com/browsers/browsers_stats.asp

Screen Size: As for screen resolution, the most widespread one is 1366x768. Source: http://www.w3schools.com/browsers/browsers_display.asp

Canvas fingerprinting: The HTML <canvas> element is used to draw graphics, on the fly, via scripting (usually JavaScript). The <canvas> element is only a container for graphics. You must use a script to actually draw the graphics. Canvas has several methods for drawing paths, boxes, circles, text, and adding images. Well-developed websites sometimes have this fingerprinting measure called canvas which is an HTML element. So basically what they do is that they create a canvas to recognize you every time you browse that site. Firefox has an extension to randomize Canvas, AD and LS same thing, same goes for Fraudfox

Webrtc: About Webrtc: WebRTC (Web Real-Time Communication) is an API definition drafted by the World Wide Web Consortium (W3C) that supports

browser-to-browser applications for voice calling, video calling, and P2P file sharing without the need of either internal or external plugins. We might be vulnerable to WebRTC IP leaks, WebRTC leaks your actual IP addresses from behind your VPN, by default. luckily Fraudfox can spoof WebRTC, LS has a webrtc changer too. You can do a WebRTC leak test here <https://browserleaks.com/webrtc>. Please don't disable WebRTC from about:config, it really doesn't look legit. AND MAKE SURE NOT TO USE CHROME FOR CARDING, SINCE YOU CANT DISABLE OR SPOOF WEBRTC ON IT!!!!!!

Plugins: Plugin Detection: all the plugins that you have installed can leave a footprint, Both LS and fraudfox can help to avoid this.

Timezone and clock: When you perform operations of carding or impersonating identities of people residing in different places with different time zone you are in the position of having to change your time zone to have to align with the one of the victim. You should match the time zone of the socks you are currently using, fortunately, with windows this operation is very simple, just go on the clock in the bottom right of windows and click "Edit Time and Date settings".

Accept Language, is, together with the User-Agent HTTP header another HTTP header which identifies the network the language used by the system that is making the navigation. Use an accept language header that matches language of the victim.

Flash Version Spoofing: Always spoof the latest flash version.

Email Spoofing: We will need to use an email that looks legit. This is not really that discussed on forums, according to Emailage So emailage checks on plenty of things:

- 1) It checks if the email has the name and surname of the customer
- 2) It calculates the score of the email domain
- 3) It calculates the age of a specific email, fraudsters are well known for creating quick emails, and that's how they can spot us, so depending on the score you get from them, they will either approve your attempt, put your order on review, or simply decline it. To make things worse, they have an internal blacklist of emails, so reusing emails with them isn't wise. They also have all the other IP validation stuff that any other anti-fraud protection provider has. So my best advice is, always put name and surname of the victim when you make an email, date of birth is a bonus. Use a good domain, gmail and private emails, the best ones are .edu emails and you can buy them from fiverr.

IP Spoofing

We will need to spoof the Cardholder location, we do that via SSH, RDP, Socksv5, etc:

- 1) The IP should country/state/city match the cardholder. The closer the better
- 2) The Chosen IP should have immaculate blacklisting (you can check blacklists on <http://www.ip-score.com> and click MORE BLS) But truth be told, sometimes it's hard to tell whether a site has really blacklisted a given IP or not, as most have an internal blacklisting, for instance, paypal might have its own internal

blacklisting. Checking blacklists is still a good indicator though.

3) The chosen IP should have a low RiskScore, Try to keep the riskscore at less than 5 It's a metric from Minfraud, you can read more here: <https://www.maxmind.com/en/explanation-of-minfraud-riskscore> You can check risk score on xdedic.biz

4) Low proxyscore: Go at getipintel.net and test the IP, the proxy score should be 0.

5) The IP has to be residential: You want to avoid datacenter IPs as they don't really look legitimate in the eyes of antifraud systems, also business IPs look good. If you are wondering whether the IP is residential or not, simply go to whoer.net, and on top you will read ISP. Generally, if the IP has an American ISP, then you are on a good track, simply google "list of American internet service providers" to get a good list of American ISP. Datacenters IPs have "data" "hosting" "cloud" and related words as ISP.

6) The IP should be as close as possible to fullz location, at least within 80 miles, I use distancebetweenecities.net

Socksv5, RDP or SSH?

Socksv5 is a protocol that works with the proxy server, a popular choice amongst carders, I believe it's the most cost effective way of spoofing your IP. However, most of fraudsters are carding through SSH nowadays

I use proxifier to link socks to my vm.

RDP stands for remote desktop protocol, you are basically connecting to a remote computer. In fraud, they are generally used to maintain bank drops and paypal middleman accounts. But they are also used for carding (rarely, but mostly depends on the amounts you are carding and where).

If you want to get RDP you should get a hacked one, since they have clean residential IP most of the time, however it's getting harder and harder to obtain a nice clean RDP, as most of them die out fast or don't have clean IPs, therefore opening a bank account can be tough, unless you obtain a clean one. Once you login to the RDP, remember to change the password and create a hidden username aka ghost user, so that the real owner will not notice, you can find the tutorial on google or youtube, it's pretty easy. Also, if you card from there, you don't have to think much about spoofing as they are an identity themselves and a real device.

So

long story short, it's mostly up to you which method you want to use, I would suggest socks or ssh, since most of you should know already how to use socks and RDP might not be the best choice for what most of you are doing here.

If you want to use SSH there's what you gonna need fam:

1) Download and install bitvise client from bitvise.com

2) Launch the software and go to SSH tab, click on all the blue links such as Key Exchange Algorithms and tick all the checkboxes, do that for all the links.

3) Go to Services tab and tick the "Enabled" box in the SOCKS/HTTP Proxy Forwarding part

4) Now, on that part, the Listen interface should be 127.0.0.1, Listen Port on 5555

5) You are done with bitwise, you will need to click on "login" tab and put the login data for SSH.

Another way is Proxifier:

1) Open proxifier and go to Profile->Proxy Servers->Add

2) On "server" put 127.0.0.1 and on "Port" put 5555,

3) On "Protocol" check SocksV5 Server

4) Go to "Profile"->Name Resolution->Uncheck "Detect DNS

Automatically"-> Check "Resolves Hostnames Through Proxy"

5) We are done with Proxifier, now all we have to do is to go and get an SSH

Remember: Host > VM with win 7 > Mac changer > VPN > RDP if you use RDP you dont need socks and if you use socks you dont need RDP it's just your choice.

Simple 12 Step guide

1. Take a laptop and turn it the internet connection off.

2. Start and Run CCleaner, after that change(spoof) your MAC address with TMAC(Technicum MAC address changer).

3. Go to a public or hacked wifi and connect with it (if you succeed to login in the router settings then OK).

4. Start your RDP with Remote Desktop Connection.

5. Install Virtual Box and CCleaner in your RDP.

6. Install the following tools in the Virtual machine who you will create in your RDP:

6.1. CCleaner.

6.2. SocksCap64.

6.3 Your Vip72 plan software.

6.4. FraudFox browser or Antidetec.

7. Change the system time zone of both RDP and VM match your victim time zone.

8. Clear the DNS cache of your RDP.

9. Put your checked by check2ip.com socks5 proxies in SocksCap64.

10. Start and configure FraudFox or Antidetec through SocksCap64.

==> AND YOU ARE READY TO START THE CARDING.

11. After your carding shit, don't forget to delete the virtual machine from VMware.

12. Look at the end of step 3. (if you succeed to login in the router settings then OK). Login in those settings and try to change the username and pass. I'm talking about 192.168.x.1 user and pass. Then when the cops come to investigate the devices connected with this router, they need to reset it but your spoofed mac address will be removed. And while the router gets restarted you must turn your wifi off.

13. After all that just do step 2 again.

Operating „in the Open“

INFOSEC is only part of OPSEC. OPSEC largely relies on your behavioural patterns. A vital part of those patterns is your shopping decisions and daily routine. Consider the following section to be a warning against short-sighted and enemy-supporting consumerist choices. The ideal revolutionary National Socialist WILL NEVER BETRAY HIS RACE OR NATION FOR CREATURE COMFORTS!

1) OPSEC ruminations by An Anon With a Clue™

If every tree falling in every forest might soon be heard by an internet-connected microphone, what hope is there for our privacy? <https://archive.fo/jv0qa>

When you're sitting in a room with an iPhone (spy phones), an Apple Watch (spy watches) and a smart assistant like Amazon Echo or Google Home (spy appliances), you're surrounded by a dozen microphones. (Newer iPhones have four and the Echo has seven, while the smartwatch has just one, for now.) Add in the latest smart wireless headphones (bugphones) — Apple's expected next-generation AirPods (spypods) or competing ones from Bose or Shure — along with talking microwave ovens (spy ovens) and TVs (spy TVs) from Samsung, LG and others, and anyone at home or in an open-plan office could soon be within earshot of hundreds of microphones.

The roadmaps of tech giants and startups alike show how sound is poised to become the first ubiquitous connection between users and the artificial-intelligence hive mind the internet is becoming.

Driving this change are massive volumes of components, originally designed for smartphones and other mobile devices. Cancer grows after all. For a hundred years, microphones consisted of a relatively large membrane whose vibrations were converted to electrical impulses. But starting in the 1980s, engineers worked out ways to make microphones tiny, bordering on microscopic.

Most still have a pocket of air trapped behind a vibrating element, but now they can be carved out of silicon, just like the microchips to which they're attached. Smartphones, smart speakers and any other gadget that listens for your voice all use these kinds of microphones.

One ongoing challenge for microphones has been physics: The smaller microphones get, the more of them you need to capture a sound, and the more processing of that sound is required.

Startups such as Boston-based Vesper Technologies, Inc. — which has received money from Baidu, Bose and Amazon's Alexa Fund — are meeting the challenge with even tinier, yet more capable designs built around minuscule flaps of silicon that generate electric current when bent by sound waves. Vesper claims this gives their microphone unique capabilities, like understanding your voice even in windy conditions, and drawing zero power when awaiting a “wake word,” since sound itself generates the power the microphone needs.

We're moving toward a world in which everything with a plug or battery can respond to a voice command.

Apple's next AirPods (spypods) could have many of the capabilities that Vesper claims its microphones will enable, such as built-in noise cancellation. (In the past, Apple has used several suppliers for its microphones.) Meanwhile, the CEO of Samsung's consumer-electronics division recently told The Wall Street Journal that by 2020 his company plans to equip every single device it sells—from TVs to refrigerators—with microphones.

It could be unnerving to be surrounded by listening devices, but the paradox is that as the technology develops, so does our ability to free these gadgets from having to connect to the internet.

Consider the voice-controlled trash can (spy cans) from Simplehuman. Say "Open can" and it opens—and then closes on its own once the user walks away. That's it. It's easy to make fun of a high-tech trash can, especially one that costs \$200. As anyone who lives with multiple virtual assistants can attest, it is tricky to talk to one without inadvertently involving the whole crowd.

Consumers must do everything to stop this from happening and BOYCOTT all these spy products. <https://archive.fo/u2rcj>

2) Physical OPSEC and Usage Behaviour

<http://archive.is/lM6ZA>

The following list of 17 points was written with the absolute human limits of OPSEC in mind. It is to be followed by the most committed of resistance warriors.

- 1) Don't use social media. Avoid Facebook/Myspace/ Twitter/ Snapchat/etc.
- 2) Forward secrecy (keep your mouth shut about any personal info if you don't want to expose yourself)
- 3) Use a cheap private VPN (w/ no IP logging) and Tor browser!
- 4) Always disconnect your internet (physically) when you are not going to use it! Make sure bluetooth and WiFi is physically disabled. Don't keep it online all the time! If you do, you are asking to be hacked!
- 5) Use an old "flipper" phone. AKA a jitterbug. Cover up any camera if has one. Jitterbugs are basic cellphones for the disabled/senior citizens. Just a bare basic cell phone where you can take out the battery. Has no internet platform.
- 6) Flock to flea markets, garage sales, thrift shops to buy older electronics! Do not buy 'smart' or 'green' appliances! Learn how to maintain and fix older products/utilities too! All IoT (Internet of Things) tech can be used to spy on you, avoid IoT!
- 7) Never put your real name or personal info into your computer, always use FAKE names / aliases.
- 8) Face-to-face relationships are the best kind. Don't be afraid to hang with your friends now and then.
- 9) Always bleach your browser cache / cookies / web logs! 35x gutmann style (Note: the person who wrote this was too paranoid. Take the information

provided as the absolute highest possible safety standards, beyond what is reasonable.)! (Bleachbit, CCleaner, etc.)

10) No OS is safe. Just exclude as much personal information you can from your Operating System. Make sure its disconnected offline when not being used! Make sure bluetooth and WiFi is also physically disabled when not in use.

11) Browser Security: Use Noscript add-on. Noscript is a must: make sure to block all global scripts, wipe the whitelist in Noscript and re-configure the whitelist that best fits your browser habits. IPFlood is also a useful add-on to obfuscate IP GET requests. You should use Random Agent Spoofer (or Blender) to spoof your browser & OS metadata while you surf the web, making it a lot harder to track your activity. Tin Foil is another great security add-on.

12) It's best to have two computers, rather than just one. For example, have one just for banking/legit LEGAL purposes. Have another one (completely separated) just for private or illegal activity. Make sure you don't put any personal info in the private computer.

13) Use encryption and strong passwords! Write them down on a piece of paper or memorize them. DO NOT store passwords on a computer file. That is a big no-no! Try easy to remember long sentences for passwords, and combine all the words together. The more characters used, the harder it is for hackers to break the passwords.

14) Have separate email accounts for each kind of activity.

15) Make sure you physically disconnect your web cam or cover it up with black electrical tape. Most laptops these days come with web cams attached above or below the monitor. Make sure the camera cannot be used to identify you or spy on you in any way.

16) Avoid new "Smart TVs"! If you have a newer TV, make sure you cover up or unplug the camera and microphone. Or, keep it offline and disconnected from the cable box when not in use. You could cancel cable and rip DVDs of your favorite movies and shows instead (See footnote), using it for offline purposes only.

17) Avoid all new digitized vehicles. They can easily be hacked, used to spy on you and even be remotely hijacked by criminal entities/governments!

3) Meta data usage

i) Examples of Meta data usage

The following list may be written in a humorous manner but the information contained within is dead serious. Do not let your operation get blown up by metadata leakages or anomalies.

- 1) When 2 phones go offline simultaneously and then go online again simultaneously, then the likelihood that those 2 individuals have just met, and are engaged in a secret enterprise, is high.
- 2) One number goes offline and then another goes online (sim switching).
- 3) Uncle Ahmed calls Afghanistan suddenly every week; perhaps this means uncle Ahmed decided he wants to be famous and fuck goats in heaven.
- 4) Keywords being heard on the mic (processed locally by the user's device) are a good way to efficiently gather intel.
- 5) Jake scored very high on the online IQ test: searches for keywords like "terrorist attacks", "explosives", watches goat-porn-in-heaven vids, visits extremist sites, uses Tor, honeypot-VPNs; well Jake must be monitored.
- 6) AI has made similar surveillance extremely effective.
- 7) Since AI have made it harder to hide, it's important to be clean when using the internet without prior procedures. That way even if they ever decide to pin something on you to neutralize you, they can't do so easily.
- 8) Another exploit they can use (if they have access to ISP logs) is meta data from Tor usage. Eg. you start using Tor at about 6:00am every night, and at 6:05am there is only one person posting on a revolutionary forum for 30'. Then the moment the posting stops, you close Tor and start browsing the internet normally.

These are all examples of meta data which can be used by the enemy to identify your online presence.

4) Further OPSEC related resources

Prevent yourself from being doxed - <http://archive.is/deaBB>
<https://pastebin.com/8zGxwtEB>

Further anti-dox OPSEC procedures - <http://archive.is/lgJCN>

Removing exif and meta data - <http://archive.is/Cf2Sf>

Create false leads - <http://archive.is/hP1wm>

Great tech related forums - <https://8ch.net/tech> <https://8ch.net/onion>

Detailed OPSEC guide (warning pedo site) -

<http://boyvidsckkevqedz.onion/viewtopic.php?f=150&t=89829>

Beginners guide to dark web security - <https://darkwebnews.com/help-advice/dark-web-beginners-security-guide/>

Another guide to safely using TOR - <http://www.deepdotweb.com/jolly-rogers-security-guide-for-beginners/>

Safe houses

When conducting operations over the long term you will require a safe house. The Safe House by Jefferson Mack covers all you need: detailed instructions for running a false flag, maintaining security, developing escape routes, using countersurveillance techniques and clandestine communications systems, duping unsuspecting people into helping you and everything else you might need. Also consult chapter 9 of *To Break a Tyrant's Chains* by Duncan Long.

A painting of a woman in a long white dress holding a child, standing in a landscape with mountains and a cart. The scene is set in a valley with a dirt road and a cart pulled by oxen. In the background, there are large, reddish-brown mountains under a blue sky with some clouds. The overall style is that of a classical or romanticist painting.

**MAKE
YOUR
ANCESTORS
PROUD.**

NEVER FEEL GUILTY FOR WHO YOU ARE.

VI. Guerrilla Intelligence

Sun Tzu said, "Raising a host of a hundred thousand men and engaging them in war entails heavy loss on the people and a drain on the resources. The daily expenditure will amount to a thousand ounces of silver. There will be commotion at home and abroad, and men will drop out exhausted. "Opposing forces may face each other for years, striving for the victory which may be decided in a single day. This being so, to remain in ignorance of the enemy's condition simply because one grudges the outlay of a hundred ounces of silver is the height of stupidity. "One who acts thus is no leader of men, no present help to his cause, no master of victory. Thus, what enables the wise commander to strike and conquer, and achieve things beyond the reach of ordinary men, is foreknowledge. Now this foreknowledge cannot be elicited from spirits; it cannot be obtained inductively from experience, nor by a-rry deductive calculation. Knowledge of the enemy's dispositions can only be obtained from other men. Hence the use of spies, of which there are five classes:

- 1) Local spies-Having local spies means employing the services of the inhabitants of an enemy territory.
- 2) Moles-Having moles means making use of officials of the enemy.
- 3) Double agents-Having double agents means getting hold of the enemy's spies and using them for our own purposes.
- 4) Doomed spies-Having doomed spies means doing certain things openly for purposes of deception and allowing our spies to know of them and report them to the enemy (in other words, spies that are considered expendable and thus are given fabricated information).
- 5) Surviving spies-Surviving spies are those who bring back news from the enemy's camp.

When these five kinds of spy are all at work, none can discover the secret system. This is called 'divine manipulation of the threads.' It is the commander's most precious faculty. Hence it is that which none in the whole army are more intimate relations to be maintained than with spies. None should be more liberally rewarded. In no other fields should greater secrecy be preserved. "(1) Spies cannot be usefully employed without a certain intuitive sagacity; (2) They cannot be properly managed without benevolence and straightforwardness; (3) Without subtle ingenuity of mind, one cannot make certain of the truth of their reports; (4) Be subtle! Be subtle! And use your spies for every kind of waifare; (5) If a' secret piece of news is divulged by a spy before the time is ripe, he must be put to death together with the man to whom the secret was told. "Whether the object be to crush an enemy, to storm a territory, or to kill an enemy general, it is always necessary to begin by finding out the names of the attendants, the aides-de-camp, and door-keepers and sentries of the general in command. Our spies must be commissioned to ascertain these. "The enemy's spies who have come to spy on us must be sought out, tempted with bribes, led away, and comfortably housed. Thus they will become double agents and available for our service. It is through the

information brought by the double agent that we are able to acquire and employ local and inward spies. It is owing to his information, again, that we can cause the doomed spy to carry false tidings to the enemy. "Lastly, it is by his information that the surviving spy can be used on appointed occasions. The end and aim of spying in all its five varieties is knowledge of the enemy; and this knowledge can only be derived, in the first instance, from the double agent. Hence it is essential that the double agent be treated with the utmost liberality. "Hence it is only the enlightened and wise general who will use the highest intelligence of the army for purposes of spying and thereby they achieve great results. Spies are the most important asset, because on them depends an army's ability to march. " Chang Yu (Sung Dynasty), interpreting Sun Tzu, said, "In our dynasty Chief of Staff Ts'ao once pardoned a condemned man whom he then disguised as a monk and caused to swallow a ball of wax and enter Tangut. When the false monk arrived he was imprisoned. The monk told his captors about the ball of wax and soon discharged a stool. When the ball was opened, the Tanguts read a letter transmitted by Chief of Staff Ts'ao to their Director of Strategic Planning. The chieftain of the barbarians was enraged, put his minister to death, and executed the spy monk. This is the idea. But expendable agents are not confined to only one use. Sometimes I send my agents to the enemy to make a covenant of peace and then I attack."

WHAT IS INTELLIGENCE?

I don't think I could have said it as well as Sun Tzu did 2,000 years ago, but I can expand on it. In any type of warfare, intelligence about the enemy is paramount. If you are not doing a good job of it, you will lose. Information is not intelligence-information is just something someone said. If you can confirm the information through other independent sources, it becomes intelligence. This chapter is dedicated to the methods of how to obtain and process information into intelligence. In the military, it is not enough to simply have the proper clearance to get intelligence on a subject. You must have the need to know. Intelligence is provided only to those who need it in order to accomplish their mission. Intelligence matters must be held in secret because if the enemy knows you have a certain piece of information, that information becomes worthless to you. It can also compromise your sources or, even worse, cause the enemy to change his actions, which can lead to your defeat.

ORGANIZATION

Intelligence is not something deduced; it has to be sought, and it has to be worked for. This means it must be planned and controlled. As in any operation, planning cannot be overemphasized.

Intelligence operations are the responsibility of the resistance intelligence officer, or G-2. The following functions are within the organization of the intelligence section:

Underground. This is the branch that consists of spies, informants, their handlers, and the operatives that perform such tasks as sabotage, infiltration of the

enemy's institutions, mob control, and assassination.

Information Officer. The information officer is responsible for such things as psychological operations, providing information and misinformation, and spreading propaganda to the people and the outside world.

Military Intelligence. It is this group's job to gain and maintain intelligence on enemy military units, their emplacements, methods of operating, commanders, weapons, logistics, strengths, weaknesses, and what is termed the enemy's "order of battle."

Counterintelligence. Methods and procedures must be devised and enforced to prevent or minimize the enemy's ability to develop intelligence about the resistance.

Cell Organization

The underground is primarily organized into cells (fig. 48). The reason for this organization is security. The individual agent does not know the other agents; he has operational contact with the cell handler only. The cell handler manages the cell. At most, only four people can be compromised. The cell handler reports to a network manager through a "cutout" (fig. 49). Net managers get their orders and direction from the area underground director. The director reports to the area commander.

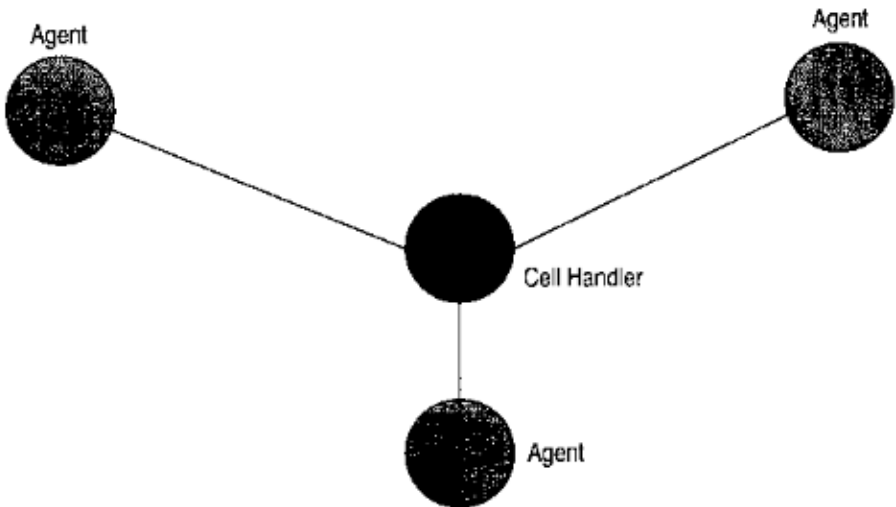

Figure 48.

All communications between cell handlers and the net manager is through the cutouts. All communications are clandestine. None of the individuals know each others real names or identities. Here is an example of a possible communications technique. The cell handler knows that he is to watch for a mark of a certain color on a certain day at a certain location. If that mark is present, he must pick up a message at a secret location. This message will be left at a hiding place that is known to him, such as behind a loose brick. This is known as a "dead letter drop." This message may contain instructions or a requirement for information. Often this message will contain instructions on the location and marking signal of the next dead drop. The person that drops the message may go to a distant location to casually observe the drop site to ensure that the message is picked up within a certain window of time and that the handler has not been followed. If it is not picked up at the proper time, it is considered null and void. Sometimes cells can be given instructions or signals via a radio broadcast. The cell member would listen for a code at a certain time on a known frequency. Often, it may be necessary to pass items between the cell

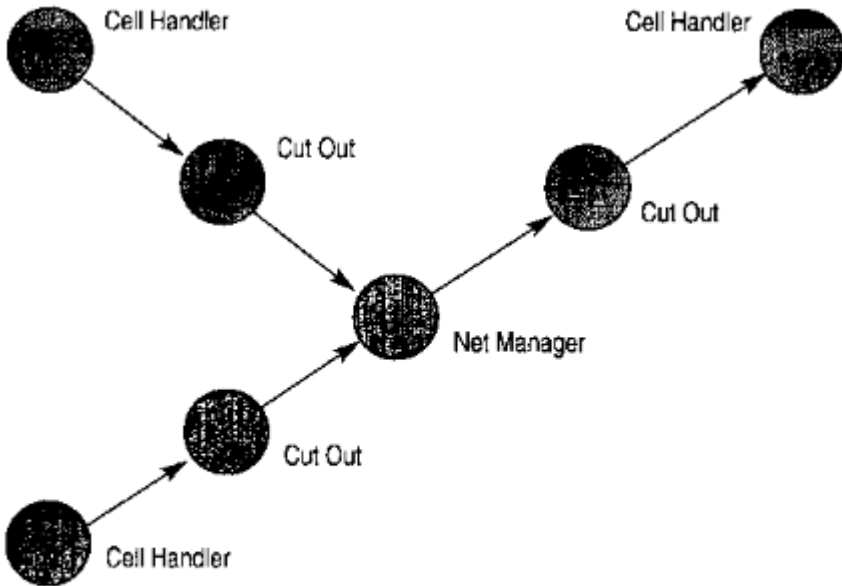

Figure 49.

and the net manager. Instructions may be given at a drop to meet someone at a certain place at a specific time. Instructions would include "all clear" and authentication codes. The information is passed between the operatives in a way that raises no suspicion. Usually, the person that takes on the function of cutout in this situation is not the usual cutout but a courier whom the cell handler has never

seen. To illustrate this, the following example is submitted. The cell handler has become aware of enemy plans that will directly affect resistance operations. The standard operating instructions for the network provides for priority communications between the handler and net manager by a prearranged signal. This is a clandestine signal that is monitored perhaps daily to tell either party that a priority communication is required. In order to keep it secret, this means is rarely used. A message is passed from the handler to a courier acting as a cutout after observing proper authentication signals and codes. The exchange may be monitored by the net manager from a distance to ensure that the transfer is not compromised in any obvious way. If the net manager feels that the transfer was not compromised, he leaves a signal to indicate to the courier that he can transfer the message. If the signal is not present, the courier goes to an alternate signal location at a designated time to look for the signal. Upon recognizing the all-clear signal, the courier leaves a signal at another location to indicate that he feels that he has not been compromised and has recognized the all clear left by the net manager. The courier then performs the transfer to the net manager using a preplanned technique such as dead letter drop or face-to-face exchange using proper recognition codes and authentication phrases. From the time this operation is started, all personnel use evasive techniques to determine if they are being followed and to prevent it.

Individuals act casual and do not take actions that would raise suspicions, even if they are being watched. Any signal left should be made in a preplanned way that would be difficult to recognize if someone were watching. For example, while palming a small piece of specific colored crayon, the person leaving the mark stops to pull up his sock. While doing so, he rests his hand against the wall to balance himself, leaving a small colored mark as the predesignated signal. Similarly, when an individual looks to see if a signal has been left, it should not be obvious. This procedure takes time, because this type of operation should not be hurried. If a member of the underground is compromised, he can be captured at best. At worst, he will not know of the compromise, and others could be compromised. This can make the cell ineffective for an extended period.

ESTABLISHMENT OF INTELLIGENCE NETWORKS

The resistance intelligence officer divides the operational area into logical zones. These zones will probably be along the lines established by the resistance command. The intelligence officer places a trained intelligence operative in charge of the underground in each zone with the mission of establishing and maintaining an effective intelligence-gathering organization in that zone. We will call this operative a "zone leader." The zone leader establishes his staff and develops a detailed written assessment of known information about the area, to include, but not limited to:

- Enemy leaders
- Military installations and units (to include unit designations)
- Potential targets

- Climate
- Industry
- Transportation
- Political, economic, and social problems and strengths
- Enemy strengths and weaknesses
- Educational institutions
- Religion and religious leaders
- Ethnic makeup
- Local attitudes toward the enemy
- Communication facilities
- Geography
- History
- Local leaders

All information is categorized and indexed in a form that will allow quick and easy retrieval and update. Primitive conditions may dictate keeping records in primitive ways such as notebooks or card files, although the use of computers in some areas may be possible. Whatever methods are used, they must be carefully controlled, and there should be a backup. They should also be capable of being destroyed easily and quickly. Information about enemy military units should be plotted on a map using standardized military symbols. This information should be maintained and kept as up to date as possible. Zones can be logically divided into smaller areas. These areas can be given names. These names are used to store information about the areas for easy retrieval. As an example, if the information is to be stored in an indexed file, it is stored by the given name for easy access.

Recruitment

In each area, spotters will be placed. Spotters live in the area and either are or become intimately aware of the people in the area who may be inclined to be sympathetic to the resistance. They also look for individuals who are aggressive in their opposition to the resistance. The people the spotter looks for are potential agents in the network or potential targets for termination. Potential agents must be intelligent and motivated ideologically against the enemy. The spotters also look for people who are in influential or informed positions who could be bribed or coerced into cooperating. Spotters take note of vulnerabilities of enemy leaders. Tu Yu said, "We select men who are clever; talented, wise, and able to gain access to those of the enemy who are intimate with sovereign and members of the nobility. Thus they are able to observe the enemy's movements and learn of his doings and his plans. Having learned the true state of affairs, they return to tell us. Therefore they are called 'living' agents." Tu Mu said, "These are people who can come and go and communicate reports. As living spies we must recruit men who are intelligent but appear to be stupid; who seem to be dull but are strong in heart; men who are agile, vigorous, hardy, and brave; well-versed in lowly matters and able to endure hunger; cold, filth, and humiliation. "Of all those in the army close to the commander; none is more intimate than the secret agent; of all rewards none

are more liberal than those given to secret agents; of all matters, none is more confidential than those relating to secret operations. " Sun Tzu said, "If plans relating to secret operations are prematurely divulged, the agent and all those whom he spoke of them shall be put to death. " The spotter must not let it be known that he is a spotter.

He must not raise any suspicion. The spotter only identifies candidates. He gives information about the candidates to a recruiter. Such candidates can be classed as sympathetic and unsympathetic.

Sympathetic

Sympathetic candidates are those who are not aligned with the enemy and tend to dislike the enemy. They include:

Persons who have a relative or friend who has been harmed by the enemy.

Persons who have seen injustice and mistreatment by the enemy.

Loners who have few friends but tend to sympathize with the resistance or are disaffected by the enemy government.

Prostitutes who are patronized by enemy leaders or soldiers.

Intellectuals who realize the harm the enemy oppression is causing to the people.

Government officials who are worthy men but may have been deprived of office. Others who have committed errors and have been punished. Greedy officials who have remained too long in a lowly office. Those who have not obtained responsible positions, and those whose sole desire is to take advantage of times of trouble to extend the scope of their own powers. Those who are two-faced, changeable, and deceitful who are always sitting on the fence. In the case of sympathetic candidates, the recruiter for that area attempts to recruit the individual to serve the resistance underground. The recruiter usually will try to establish a friendship with the candidate and gain his/her trust. (Recruiters should be good at dealing with people and persuasive.) From the beginning, the recruiter attempts to analyze the candidate's psychology, political inclinations, goals, fears, and ambitions. He must be careful not to patronize or be overly aggressive in developing a relationship with the candidate. If and when the recruiter feels the candidate would be sympathetic to helping the resistance, he attempts to recruit him or her. Often the recruiter can accomplish this without the candidate realizing that it is deliberate. This is desirable for more than one reason. For security reasons, the recruiter will want to leave the area after all recruiting in that area has been accomplished (ideally, all recruitment is culminated at the same time). Also, the candidate could resent an obvious recruitment if he/she realizes this is why the recruiter was interested in befriending the candidate. The recruiter introduces an agreeable candidate to a handler. The handler adds the new agent to his cell. The handler trains the recruits and guides them in the gathering of information, clandestine communications, countersurveillance, etc.

Unsympathetic

Unsympathetic candidates tend to be neutral or aligned with the enemy but are vulnerable perhaps due to something they have done or could be tempted into doing (financial problems, alcoholism, drug addiction, infidelity, etc.).

Enemy leaders who can be compromised, blackmailed, bribed, or threatened.

Enemy military personnel with weaknesses that the spotter has identified.

Government employees in key positions such as postal personnel, clerks for leaders, couriers, security personnel, logistical personnel, communications experts, etc.

Enemy agents.

"When the enemy sends spies to pry into my accomplishments or lack of them, I bribe them lavishly, turn them around, and make them my agents." (Li Ch'uan, c. 618-905 A.D)

Unsympathetic candidates can be spotted and recruited in much the same way as sympathetic candidates, but it normally requires a different motivation, whether it be, as examples, fear of being compromised after being photographed with the wrong person or doing the wrong thing. Another approach is for the recruiter to ask a seemingly small favor that is a minor breach of security and then pay for it. The payment could be much more than the information is worth, and such small favors can continue until the recruiter asks for a larger favor. If the individual refuses, he is threatened with exposure. Photographs, canceled checks, and other forms of proof can be used to put teeth in the threat. If this person does not cooperate or if the recruiter feels the individual may go to the authorities, he should be lured to a place that allows his termination and the escape of the recruiter. The recruiter will leave the area because of his association with the individual. If the candidate has intimate knowledge of an enemy installation that is a planned target, he could give up much information to a recruiter in casual conversation. If the target is to be attacked, the candidate can be kidnapped after being lured to an area where there are no witnesses and interrogated for detailed information that will assist in the attack. Last but not least, information can often be bought. If information is paid for but turns out to be false, action should be taken to ensure the individual understands his mistake and doesn't make it again, and that others gain enlightenment from his mistake.

Information Flow

The flow of information is from the cells up to the area command. Only the area command maintains the information and processes it into intelligence. This is not to say that at lower levels within the command individual leaders do not try to catalog information and process it mentally; they just don't process it before passing it up. The area command has much better resources to check the information for authenticity and accuracy. It can also be compared with intelligence gained from other areas to form a bigger picture of enemy strategy,

capabilities, strengths, and weaknesses. Intelligence ultimately is disseminated on a need-to-know basis only to allow secure planning of operations and enhance the security of subordinate units.

Military Intelligence

Military intelligence requires a separate group to gain and maintain intelligence on enemy military units, their emplacements, methods of operating, commanders, weapons, logistics, strengths, weaknesses, discipline, and tactics. To gain information, the military branch of the resistance conducts operations. Very often, information is obtained during both offensive and defensive tactical operations. Operations conducted with the specific purpose of gaining information consist of, but are not limited to reconnaissance and prisoner snatches.

Reconnaissance

Small teams are sent out to observe and not be detected.

If they are detected, the information may not be as useful, or they may be overwhelmed by a superior enemy force. They may be sent to confirm or deny other sources of information or to gather information that will be used for the planning of local operations. Recon teams can be used to watch trails, roads, rivers, and other transportation corridors. They can watch small towns, villages, and enemy facilities and encampments. Teams make detailed notes and drawings. They note when and where things are seen or happen.

Prisoner Snatch

Teams can be sent to capture an enemy soldier or government official. Because of the need for surprise, a small team is usually used. Larger units may be stationed to support the snatch team after seizure of the target. Usually, silent capture is desirable because of the likelihood of enemy reaction. Techniques used for the snatch will depend upon the situation, but regardless of what techniques are used, they are characterized by detailed planning and preparation, surprise, stealth, speed, overwhelming superiority, and support.

NOTE: One thing to bear in mind when deciding the method of disabling the target is that excessive blood loss causes shock. Shock causes death. Dead men cannot talk.

The snatch team may recon the area to determine the best location and time to execute the operation. Detailed information is needed on such things as routes and methods of enemy travel, size of patrols, size of point elements, security measures, weapons, readiness (do they carry their weapons at the ready?), alertness, discipline, and techniques for such things as gathering water (do they come alone to get water?), and relieving themselves (do they use the buddy system?). Specific questions to be answered include when does the enemy sweep roads in the area? How far do they sweep on each side? Are routes to and from enemy watering points and latrines guarded? What areas along enemy routes of travel are difficult to observe? What are the best approaches to and from the enemy routes of travel? Once the snatch team has the information it needs, the

leader finalizes plans. The team will have rehearsed the technique to be used before entering the area. The best routes of approach and withdrawal are selected, and whatever support is available is briefed. In Vietnam, American forces had the advantage of air support. When snatch operations were conducted, we could call for extraction. This will most likely not be available to the insurgent. Instead, the enemy may have aircraft as well as reinforcements. This situation may make delaying techniques appealing. Trip wires, antipersonnel mines, indirect fire support, snipers, ambushes, and diversions are all methods of delaying enemy reaction to fire. Some U.S. Army Special Forces snatch operations in Vietnam (and surrounding countries) used the ambush in conjunction with pure bravado to take prisoners. This was done after an extensive recon. One such technique had the team leader along with another man positioned a few feet up the trail from the rest of the team, which would be laying in ambush. When a small enemy patrol walked by, the two men would move out onto the trail behind the last man. The team leader would have a baseball bat; the other man would have his weapon ready to shoot anyone who looked back. It was timed such that when the enemy patrol moved into the kill zone, the man with the bat hit the last man across the back of the shoulders very hard. He would then fall to the ground on top of the target while the ambush was sprung. All other enemy personnel were killed by the ambush and the man next to the team leader. Usually someone had a tranquilizer injection ready to sedate the target to help control him and prevent shock. The operation was carefully planned and timed. Helicopter extraction was done as soon as possible. An observation plane and possibly helicopter gun ships and jets were waiting to provide air support. Preplanned landing zones were used (primary and alternates). As said before, a guerrilla force is not likely to have extensive support, so good intelligence, recon, planning, rehearsals, local support, and delaying techniques take on added importance.

Prisoner Interrogation

After combat or a mission you may capture prisoners. Detailed interrogation methods are outside of the scope of SS Paladin so consult *Interrogation: Science and Art* by Intelligence Science Board among other in depth guides to getting the most out of your interrogation.

In spite of popular opinion, interrogating an enemy soldier is not done with a big knife pressed against his throat. It is best done by a trained person or team of interrogators. With rare exceptions, a terrified person will tell you anything he thinks you want to hear to save his life. Instead, taking the person away from the immediate combat area, isolating him from people and creature comforts, providing minimal water and food, and preventing him from relieving himself or sleeping will usually weaken his will. When the prisoner is ready for interrogation, one method used is the Mutt and Jeff technique. It works like this. A two-man interrogation technique is used, and their performance must be convincing. One interrogator is openly hostile and does most of the talking while the other one observes. If the prisoner does not become cooperative, any information that may be already known is used against him. He is asked questions

for which the answers are known by the interrogators. Whenever he lies he is punished (nonlethal). He is told that they already know the answers to most of the questions, but they need him to verify certain things. If the prisoner remains uncooperative, the aggressive interrogator pretends to make an attempt to harm him but is stopped by the silent one. The less aggressive interrogator convinces the aggressive one to leave and let him conduct the interrogation. The interrogator tells the prisoner that he saved him this time, but he may not be there next time. In order to prevent him from getting hurt, he needs some cooperation. He tells him to give him something, no matter how small. The interrogator then asks questions that he already knows the answers to (if possible). When he starts getting truthful cooperation, he begins asking real questions. The interrogator may give small rewards for cooperation. He attempts to develop a sense of trust but maintains strict control. After a prisoner begins to cooperate, the interrogator attempts to reconstruct as much of the detail prior to his capture as possible. One very good method of doing this is map tracking. The interrogator uses a map to locate where the individual was captured and goes backward in time, asking the individual detailed questions about every aspect of his activities. The interrogator can trace the prisoner's movements prior to capture by asking questions about key terrain features, water sources, towns, etc. The interrogator goes back as far as he can. Initially, he is interested in information of an immediate nature. Later, after such information has been sent forward to be evaluated, the interrogator seeks longer term information such as the prisoner's induction into the military, type and location of training, the units he has been with and when, names of commanders and fellow soldiers, and discipline of units.

Feints and Ruses

Operations can be conducted to see how the enemy will react in order to gain information about his tactics, weapons, discipline, etc. Resistance forces can fake activities to fool the enemy and gain intelligence. Rumors can be spread by the underground and auxiliary to cause the enemy to respond. Do they act on rumors? Do they send recon teams? If the resistance does it enough, do they stop responding? When the enemy stops responding, it may signal frustration or a realization that they should react to valid intelligence and not rumors. When they realize this, there may be an extended lag in time until they can develop and process intelligence. This window may provide opportunities.

Tactical Operations

Much of the military information about the enemy is gathered during the conduct of normal combat operations. Resistance forces must be taught how to gather information about the enemy and report it to their leaders. Leaders send the information forward as soon as possible. Often, intelligence officers accompany the resistance forces on combat operations in order to conduct training, observe procedures for gathering information, and advise leaders about gathering information. Each unit must adhere to standard procedures for gathering and

forwarding information. Normally, the military intelligence group establishes these procedures and may perform audits on units (with permission of the unit commander).

Debriefing

After all operations, the unit goes through a debriefing.

This debriefing should be conducted by a trained intelligence officer.

Often, intelligence personnel are permanently assigned to units. Debriefings are done to gather as much information about the enemy and his activities as possible. Information about the terrain, civilians, transportation routes, weather, and anything else the intelligence officer feels is valid is covered in a thorough debriefing. Photographs, drawings, terrain models, and maps are useful.

COUNTERINTELLIGENCE

Counterintelligence is comprised of actions taken to prevent or reduce the enemy's ability to gain information about the resistance. The following are miscellaneous counterintelligence issues applicable to the guerrilla warfare environment. Need to Know. As mentioned before, even if a member of the resistance is cleared to receive a level of classified information, he is not allowed access to it unless he has the need to know.

Restricted Access. Restricting access is reducing or eliminating nonessential personnel access to or through an area. This is to prevent them from gaining knowledge of friendly actions, equipment, or installations that could later be compromised to the enemy. As an example of this, if the resistance forces use a bordering country as a sanctuary, they should attempt to control areas of the border or make them no man's land. The movement of all personnel other than active partisan fighters in this area is made to be very dangerous. One of the reasons for this is to deny the enemy information about movements along the border. Another reason is to help prevent the enemy from isolating the resistance from their sanctuaries or interrupting the movement of supplies, wounded, or reinforcements. Another example of restricted access is securing an area where the resistance is making some type of tactical preparation, such as an isolation area. Isolation areas are where units are taken to separate them from all others before giving them a mission to prepare for. Until they return from the mission, contact with anyone outside of the unit is forbidden to prevent security leaks.

Diaries. Soldiers are not allowed to maintain diaries. If these fall into enemy hands, they can provide valuable information to the enemy. Letters. Soldiers should be allowed to correspond with loved ones, but it should be limited in frequency and time. If preparations are being made for an operation, they should not be allowed to write or mail letters. During times of limited activity, they may give the letters to a designated intelligence officer. This person may censor these letters to prevent sensitive information from being compromised inadvertently.

Conversation.

Troops are instructed not to discuss military matters with others. If a civilian or

anyone else that does not have the need to know asks questions about his unit's mission, encampments, weapons strength, etc., it should be reported.

Telephone Security. As with radios, persons that use the telephone should know that the enemy is probably listening. In some situations, computers with high-speed modems can be used. If available, some sort of good encryption software should be used.

Other Forms of Communications. When time and circumstances permit, communications other than radio should be used. Such methods include messengers, signal mirrors, flags, smoke, and homing pigeons. If messages are very simple, they may be memorized for security, but the message is subject to distortion, and it cannot be coded very well. Most situations will call for written, coded messages.

Equipment. Troops are instructed to avoid abandoning equipment because the enemy can often gain intelligence from it or use it against them. If equipment cannot be taken with them, they destroy it to prevent its use by the enemy.

Personnel Killed in Action. Every attempt is made to not leave dead personnel behind, because in addition to the morale problems it can cause, the enemy may get valuable information from them such as physical conditioning, health, nutrition, armaments, and discipline. If he is identified, retaliation against his family or village could result. If the dead must be left, an attempt is made to sterilize them by removing anything that could provide information to the enemy.

Documentation. All documentation is strictly controlled, and if the unit is about to be overrun, it is destroyed. The preferred method of destruction is to burn it and spread the ashes.

False Information. Incorrect information can be left where it is likely to be found by the enemy. This could give false information about planned operations or personnel, or it can implicate an enemy official.

Refugee Camps. In many situations, war creates refugees. Refugees often end up in camps. These camps should be avoided by the guerrillas as a whole since the enemy can be expected to have agents in them or at least watch them. If family members or friends are in these camps, guerrillas will try to contact them. They should be restricted from these camps. Any communications with individuals in the camps should be done through members of the resistance assigned to this task. The refugees can be expected to repeat what they hear.

Local Security. Tactical units must actively patrol and observe for their own security. They must never let their guard down when in hostile territory. Resistance units must never rely on civilians to warn them of enemy approach. They must have multiple avenues of withdrawal, rehearsed withdrawal plans, and a defensive plan to be used if surrounded and breakout is not immediately feasible.

Sterilizing the Area. Resistance units sterilize areas when they prepare to leave in order to make it look like they were never there. Even if the enemy does find the location, it will make discerning information from it much more difficult.

Radio Communications Security.

Radio provides a form of communications in military operations that has advantages other forms do not. But there is a price paid for this speed-security. To limit the effects of this security issue yet still use the speed of radio, the radio operator must be aware of how it becomes a security problem and take defensive measures to minimize the risk. Early in an insurgency, the use of radios should be highly restricted, especially if the enemy has any type of sophistication or has allies that do. This is because by using radio direction finding (RDF) equipment, the transmitter can be located within a few meters within seconds under excellent conditions. There should never be a radio transmission from a guerrilla base unless enemy contact has been made and they already are aware of the exact location of the base. Radio transmitters emit energy from the antenna.

Depending on the design, the radio can emit energy, if it is just turned on. The most significant amount of energy is, of course, emitted during transmission. The type of antenna used helps determine the direction or directions of the bulk of the transmitted energy. Some antennas are directional (fig. 50), some are bi-directional (fig. 51), and some are omnidirectional (360 degrees, fig. 52). By selecting the correct type of antenna, most of the energy can be directed toward the intended reception station and not in other directions. The frequency that is used makes a big difference as to the angle of energy transmitted. Higher frequency energy leaves the antenna at a flatter angle. High frequency, or HF, radio waves have what is called a "sky wave" and "ground wave." The sky wave leaves the antenna and is refracted off the ionosphere and returns to



Figure 50. A directional antenna pattern.

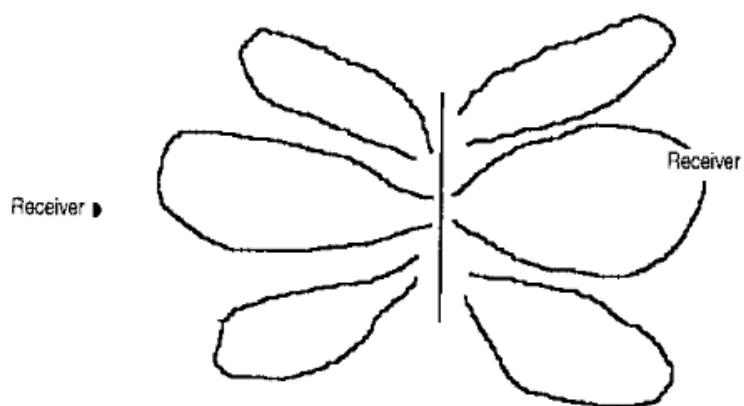

Figure 51. A bi-directional antenna pattern.

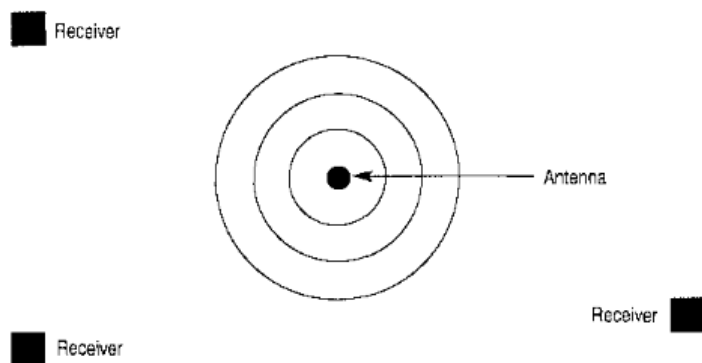

Figure 52. An omnidirectional antenna pattern (seen from above).

earth, allowing long-range communications. The ground wave leaves the antenna and travels at an angle toward the ground (fig. 53).

As shown in Figure 54, VHF frequencies transmit the bulk of their energy at a slight angle toward the ground, giving what is termed "line of sight" communications. This means that if a large mass (such as a mountain) is in the way, reception is difficult if not impossible. In the figure, communications with someone at point A would not be good. Communications with points B and C would be good depending on the distance and power of the transmitter.

The characteristics of the radiation patterns can be used to the advantage of the operator to help prevent the enemy from receiving the signal. For instance, if VHF frequencies are used, the transmitting operator can use hills and mountains to mask his transmissions.

The radio operator should always assume that the enemy is listening. He should keep transmissions as short as possible, not transmit from or near a base, use masking techniques, and, if possible, use directional antennas. To help keep the transmissions short and add to security, the operator should use call signs, code words, and brevity codes.

Call signs are meaningless names given to the unit or individuals that are known only to those with the need to know. Code words are used to give uncommon names to things so that others will not know what is being referred to. Do not use obvious code words such as "sticks" to mean rifles or "big guy" to indicate a leader. Code words should be changed often.

Brevity codes are used most often when ordering supplies. Numbers given to items in a supply catalog are used as brevity codes. As an example, 112 could mean rifles, 111 could mean rice, 443 could indicate grenades, etc. Often a number will indicate not only the type of supplies requested but also the amount. So 167 could indicate 500 rounds of ammunition, 456 could indicate 2,000 rounds of ammunition, and 432 could mean 10 kg of rice.

If the guerrillas have the technology, burst transmissions can be used to keep the transmissions short. Packet radio is a technology that is cheap and available in many places. Packet radio uses a personal computer, special software, packet modem, and radio to send messages at much higher speed than they could be spoken.

This text does not intend to teach you the many details of how to be a radio operator. Rather, it gives an insurgent a basic understanding of the security matters involved and advises that radio operations should be done by trained personnel.

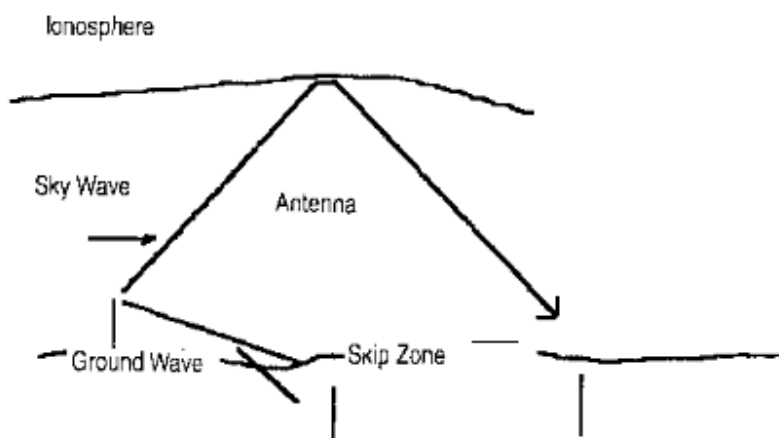

Figure 53. Sky wave and ground wave.

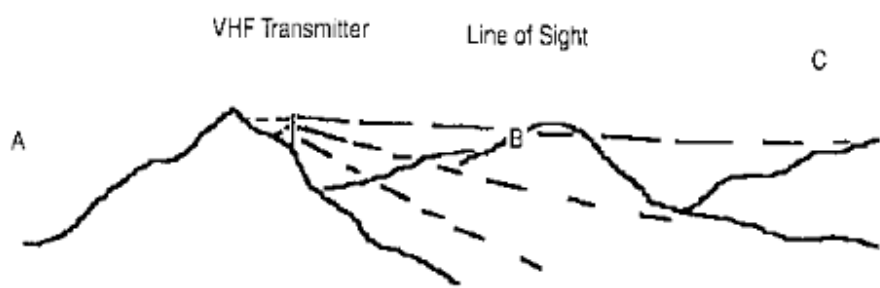

Figure 54. Line of sight transmissions.

VII. Secret Meetings

Secret Meetings Guide

A security service like the FBI can only achieve its objectives by intercepting communication between people. This means you can beat the security service if you can deny them the ability to overhear your meetings with your contacts. Of course, this guide is to be interpreted not through an American lens but with the correct local political dynamics in mind.

Does your local anti-National Socialist security agency rely on SIGINT or HUMINT more? Are you unsure? Study your enemy.

Contents

- 1) What you'll learn here...
- 2) Step-by-step instructions...
 - a) Step 1
 - b) Step 2
 - c) Step 3
 - d) Step 4
 - e) Step 5
 - f) Step 6
 - g) Step 7
- 3) Spook talk...

1) What you'll learn here...

This section teaches you how to check for surveillance before you meet with a clandestine contact. You'll **learn a protocol that will beat security services** like the FBI, BATF, DEA, and others. The method is particularly effective against standard police surveillance. It also works against the so-called inspection teams of the IRS.

Tradecraft origins: The method described in this article was originally devised in 1943-1944 by countersurveillance expert Anthony Blunt for Britain's MI.5. Unfortunately for the British, Blunt was a deep-cover agent for the KGB. Six years later, Blunt taught the protocol to his new KGB controller, Yuri Modin. Together they perfected the technique as it is known today. They successfully thwarted MI.5 surveillance for three years, sometimes even meeting daily to exchange information and top secret documents. In effect, Blunt was using his inside knowledge of MI.5's surveillance techniques to beat them at their own game.

Proliferation: This countersurveillance method has since been adopted by Israel's Mossad, Germany's BND, Russia's KGB (now the SVR), the American CIA, and many others. The protocol is taught by intelligence agencies to their controllers - these are the intelligence officers who manage and meet with deep cover agents in foreign countries. The method is also being used today by resistance movements and urban guerrilla groups.

When this countersurveillance protocol is methodically applied, it is extremely difficult for a security service to breach your security.

2) Step-by-step instructions...

Here's a hypothetical situation. Assume that you and I wish to meet clandestinely. We wish to ensure that our meeting is not observed by a surveillance team.

You and I have previously agreed upon a place, date, and time. In addition, we are familiar with each other's appearance - we can recognize each other on sight.

Step 1: You and I independently arrive at the previously agreed-upon general location. Rather than fixing a specific location, we agree to be only in the general vicinity. This is an important principle.

This might be a large park, a residential district, etc. The location must be outdoors and free of video surveillance cameras. It should also be selected with the intention of thwarting telephoto lenses.

You and I should each know the area well. The location should provide reasonable cover for each of us being there - strolling in the park, walking through a residential area to a bus stop, convenience store, etc.

Step 2: You and I will eventually make eye contact at some distance from each other. We do this discretely, so others are unaware. I use a pre-arranged signal to alert you that I have spotted you. Perhaps I'll throw my jacket over my shoulder, or remove and clean my sunglasses, etc. The signal must be a natural movement that does not attract unwanted attention.

Safety first: Even though you and I have seen each other, we do NOT approach each other. This is an important safety valve. If either of us has grown a tail we do not want to compromise the other person.

BACKGROUND: The phrase grown a tail is spy-talk for being under surveillance. The phrase is somewhat inaccurate, because they don't just follow you, they often surround you.

Step 3: When you see my signal you simply walk off. Then I follow you in order to ensure that you're not being watched. I carefully check for the presence of a floating-box foot surveillance team. I check for agents at fixed observation posts. I also watch for drive-by support from a floating-box vehicle surveillance team.

BACKGROUND: In particular, I may follow you, I may walk parallel to you, I may occasionally walk ahead of you. The goal is simply to be nearby so I'm in a position to detect surveillance around you. I always remain at a distance from you, of course, never approaching too closely.

Step 4: When I have satisfied myself that you are clean, I again signal you. Perhaps I re-tie my shoe laces.

Step 5: Now we reverse roles and this time it is I who simply walks off. You begin to follow me in order to ensure that I'm not being watched. You check for floating-box foot surveillance, fixed observation post foot surveillance, and drive-by support by a vehicle surveillance team.

What to look for: You carefully watch for persons who are pacing me or moving parallel with me. You check for persons loitering at positions with a good line-of-sight to my location. You watch for an ongoing pattern of people coming and going

that results in someone always being in a position to monitor me. You watch for vehicles dropping someone off ahead of me.

Step 6: When you are satisfied that I am clean, you signal me that I'm not being watched. (On the other hand, if you suspect that a surveillance team is in the vicinity, you simply abort the operation and walk away.)

BACKGROUND: You must trust your instincts, because if something seems not quite right it's better to be safe than sorry. Many people are surprised to learn that it is not difficult to detect a surveillance team watching someone else. This is the subtle elegance of Blunt's countersurveillance system. And the goons are helpless against it.

Step 7: You and I can now approach each other and meet. After our discussion we agree upon the date, time, and location of our next clandestine meeting - as well as two backup plans in case the meeting is thwarted by surveillance. If we are unable to meet at the first venue we will use our fallback position and we will meet at the same time and place one week later. If we are unable to make that meeting happen, we will shift to a previously agreed-upon failsafe plan and we will meet at a different location at an agreed-upon date and time.

Neither you nor I writes down the particulars of our next meeting. We commit the details to memory.

BACKGROUND 1: If you have any documents to give me, I will not accept those documents until the final moments of our meeting. I will have already started making my getaway when I accept the documents. This reduces the chance of discovery and arrest by a surveillance team that has managed to elude our countersurveillance protocol. If the security service acts too quickly, they will have no evidence against me, because the documents have not yet been passed to me.

BACKGROUND 2: The best agents never mix discussion and documents. If a document is to be passed, no discussion occurs. The entire contact takes only a moment - the perfect brushpass. The principle is simple. It is foolhardy to stand around holding incriminating documents.

Spook talk...

Spies in North America call this seven-step protocol for countersurveillance drycleaning. In Europe, it is called *parcours de sécurité* - a French phrase which can be translated as security run or security circuit.

VIII. USB dead drops

Create a USB Dead Drop in Nature by DIY Hacks and How Tos

Dead drop is an anonymous, offline, peer-to-peer file sharing network in public space. This network is made up of USB drives that are embedded in walls, buildings and other public places. Anyone is free to access, download, and upload. It is very similar to geocaching but with data. The first USB dead drop network of five locations was created by Berlin-based artist Aram Bartholl in 2010. Since then, there have been over 1,000 dead drop locations that have been registered at deaddrops.com (**WARNING: deaddrops.com is as of July 2018 a 3rd party, be sure to make yourself aware of whether their status has changed politically**). For a walk through of how to set up a standard USB dead drop, check out this instructable by user frenzy.

Up until now, this has been mostly restricted to urban locations. In this instructable, I am going to attempt to expand this project beyond city limits by showing everyone how to embed USB drives in natural fixtures such as trees and rocks.

Contents

- 1) Materials
- 2) Remove the Housing of the USB Drive
- 3) Wrap the USB Drive in Plumber's Tape
- 4) Select a Dead Tree or Stump as a Dead Drop Location
- 5) Drill Holes in the Trunk to Make Room for Your USB Drive
- 6) Apply the Wood Glue and Insert the USB Drive
- 7) Finished Dead Drop Site
- 8) Stone Dead Drop Location

1) Materials

To install a USB drive in a tree, you will need the following materials:

Materials: USB flash drive, Plumber's tape, Wood Glue

Tools: Cordless Drill, Drill bit, set Screwdriver, or other tool to pry open the flash drive

2) Remove the Housing of the USB Drive

The first step is to open up the housing of the flash drive and remove all the unnecessary plastic. You can usually pry open the housing with a small screw driver or knife. Another option is to just squeeze the housing with a pair of pliers at the seam. Continue removing parts until only the USB connector and the circuit board remain.

3) Wrap the USB Drive in Plumber's Tape

Applying a layer of plumber's tape around the circuit board of the drive helps to keep it a little more protected. Don't go overboard, one or two layers is plenty.

4) Select a Dead Tree or Stump as a Dead Drop Location

Select a dead tree to locate your dead drop. I do not recommend using a healthy tree for this project. In addition to the damage caused by drilling, the cavity that

you create also provides a potential site for mold, rot and insects to take up residence. Because of this, I recommend using a tree that is obviously dead, fallen over, or just a stump.

5) Drill Holes in the Trunk to Make Room for Your USB Drive

The USB connector and board of a typical USB drive is about 0.51inch (13mm) wide x 0.20inch (5mm) thick. There are a number of ways that you can drill out a slot to accommodate for it. The simplest and fastest method is to drill a single hole that is large enough to fit the whole drive inside of it. A 1/2" drill bit will usually suffice for this.

If you want to make a smaller imprint on the surface and make the end product look a little cleaner, you can drill a series of smaller holes in a line to make a slot. Each hole should be the same thickness as the USB drive (about 0.64cm). Then you can finish the shaping with a knife or file.

Be sure to drill your hole is a part of the tree that is solid and free from rot.

6) Apply the Wood Glue and Insert the USB Drive

Clear the saw dust and wood shavings from the hole by blowing on it. Then fill the hole most of the way with wood glue. Slowly insert the USB drive into the hole until the back edge of the metal on the connector port is even with the surface of the tree. Some of the glue will squeeze out around the edges. Wipe off the excess using some nearby leaves.

Once the glue dries, you have a USB dead drop site out in nature. If you wish to prolong the life of the drive, you can put a cap on it (or over it) to at least partially protect it from the weather.

7) Finished Dead Drop Site

The last step is to upload the instruction text files and any other files that you want to share. Reminder: deaddrops.com is a 3rd party. You can find the readme file here: <http://deaddrops.com/download/readme.txt> To document the dead drop location, it helps if you take three pictures of the location (up close medium and far away). This makes it easier for others to find your dead drop.

8) Stone Dead Drop Location

You don't need to limit yourself to just trees. You can also setup a dead drop in stone. The process for this variation is identical to the original procedure that is used for brick and mortar locations. Just find a relatively soft rock, drill the hole with a mortar drill bit and use a concrete patch or fast drying cement instead of glue to fill the hole. <http://www.instructables.com/id/Create-a-USB-Dead-Drop-in-Nature/>

Party van with Pirate Box and Botnet

This concept is only for the most dedicated and technically capable. Implementing it requires determination, good driving and an intimate knowledge of INFOSEC. It has been dubbed the „Party van“ since inside of it you will be having a continuous party, but there is another Party Van which has letters belonging to an „Alphabet Soup“ agency attached to it awaiting you if you go for this method.

Are you mentally strong enough to becoming a bit buccaneer?

What you need:

- 1) A van or truck. A rental vehicle is recommended, though the security thereof is questionable. Intimate knowledge of the vehicle and any digital subsystems it may have is a necessity.
- 2) A „pirate box“ hacked router and antenna set-up.
- 3) A small team of 2-5 revolutionaries who are all skilled drivers.
- 4) Food rations, as you will be driving almost continuously for the entire operation.
- 5) A route plan - DO NOT DIGITIZE THE ROUTE PLAN!
- 6) A „zero-day“, or list of common wifi exploits, in order to hack nearby wifi modems.
- 7) Knowledge of how to maintain and operate a botnet, which is the product of this endeavour and can then be used against enemy digital networks.

The concept is simple. You buy rations and get your other supplies stocked up. Then you drive along your route at a leisurely pace hacking as many wifi routers (automatically! Write the script yourself!) along the way as come into range of your signal.

Law enforcement will not identify you as long as you stay on the move and avoid boosting your signal too strongly. Ideally, your connection request should not be visible to nearby wifi users. Ultimately this method depends greatly on personal computer and communications proficiency and is recommended in order to build a botnet within a week or so of continuous driving (take shifts, make sure proper vehicle maintenance is observed prior to departure and use cash at gas stations). The success of such a mission depends on careful planning of digital resources and knowledge of both cellular and 2G/3G/4G networks. If your ISP notices irregular behavior and decides to remove you from their system you must have plans around this eventuality. Dynamic IPs and multiple (or spoofed) device IDs are essential to maintain connectivity to the network, or it is entirely possible to perform the operation „offline“ if your configuration settings are adequate and you do not plan on immediately activating the botnet. The topic of botnet management should be carefully planned and directly connected to the following attacks on enemy network infrastructure.

You may picture yourself as a pirate, but first and foremost you are a National Socialist and any use of the botnet for personal gain will be identified and punished by your allies.

IX. Tactics against Law Enforcement Officers

1) Dealing with Law Enforcement

Golden Rule: Ask for a lawyer immediately upon contact and say nothing.

Do not fall for the tricks which enemy law enforcement may play. Nothing you say can help you. Law enforcement officers are not in a position to offer you a plea deal, only the prosecution is, and even then you are guaranteed a politicized verdict for having opposed their Jew cabal and stood for the liberty of your Volk.

Judges do not need to accept the plea bargain either. Law enforcement use various techniques to try and get a confession. They will try to minimize your behavior and make it seem wise to agree with them. This is a trick. An in-depth guide to law enforcement interrogation techniques is not required, because all of their techniques can be countered by refusing to speak and asking for a lawyer.

Contents

- 1) LE knocked on my door
- 2) I am being offered a deal if I turn states witness
- 3) LE is requesting to search my house or car
- 4) I got arrested and am being interrogated
- 5) If I ask a cop if they are a cop, do they have to tell me
- 6) Do LE smoke weed or use other drugs
- 7) I am non-important/don't do anything wrong
- 8) When I talk online I like to say SWIM (someone who isn't me)

So LE knocked on my door and asked to talk to me. They say that they know I have been up to no good, and that it will be better for me if I talk to them.

What should I do?

You should under no circumstances talk to LE. They are not your friends, although they may pretend to be. Unless the officer makes it clear that they are an SS member and investigating the enemy. Then discretion should be used, though generally LE are to be treated politely and with support for their role in maintaining societal integrity. However, many LE do not understand the war effort. Reading the body language of an LE will help you determine their intentions towards you and the cause. Anything you say can and will be used against you in court. In fact, anything you say will be twisted to put you in the worst possible light. Even if you think you are saying something innocent, LE can twist it against you. So it is best to say absolutely nothing. Don't try to outsmart them in an interrogation, this is not a game, if they think you are the sort of person that sees things as a game they will try and make you feel smarter than them when they question you, but in reality they are just getting you to talk more. When questioned by LE, you should immediately request to talk to your lawyer, and nothing more. Everything you say to LE should be said through a lawyer, in all cases.

Additionally, remember that destruction of evidence is a crime in many places (like the United States). **Turning your computer off is not destruction of evidence, even if you are using whole disc encryption** (and thus having the computer turned off makes the data inaccessible to the investigators); hitting your computer with a hammer, shooting it with you gun, or throwing it into your swimming pool when you see the police walking to your door is destruction of evidence, and you could be sent to prison for it (even if you are found "not guilty" of the crime itself). You can face a destruction of evidence charge even if the investigators manage to recover the evidence you tried to destroy. If you have incriminating evidence on your hard drive, you should be using encryption, not relying on your ability to destroy your computer.

So it is looking like I am going to be doing a bid in prison, but I am being offered a deal if I turn states witness. Should I do this?

It is true that you can in some cases get reduced sentences by becoming a confidential informant. But would you rather spend five years in prison getting abused and spit on, possibly killed, or spend ten years in prison being left alone for the most part? Snitches are despised more than anyone else in prison, and some of the people you will be locked up with (Communists, Life-sentence etc.) have nothing to lose. Guards are known to reveal information on inmates to other inmates, so don't think you are going to keep your snitch status secret. Even if you are kept in protective custody you will not be safe, when prison riots happen the first thing that happens is the inmates kill everyone in protective custody. In addition to putting your life in serious danger, helping the enemy makes you a coward and a hypocrite. Keep in mind that even if you take a deal to snitch, that has no legally binding power, your sentence is still up the the judge. Although the mandatory minimum is erased when you take a deal, you can still get the maximum sentence if the judge says so, even after you already snitched. This has been known to happen. Even if you get put in the witness protection program and given a new identity, people in witness protection can be traced. Snitching is never worth it and it is never the right thing to do. Don't do the crime if you can't do the time without snitching.²

So I got pulled over, or got a knock on my door, and LE is requesting to search my house or car. What should I do?

Tell them no. Never consent to be searched or have your vehicle or house searched. Make them get a warrant. Even if you have nothing on you and your vehicle and house are clean, you should make them get a warrant. You don't want to make their job easier. If you don't consent to a search and they search anyways with no warrant then any evidence they gather can not be used in court. If you consent, they don't even need a warrant.

2 This advice is mainly for your protection. Cooperation with SS aligned LE is perfectly valid, AFTER the Zionist Occupational Government in your Nation or local area is ousted. You must assume that LE will not protect you adequately.

So I got arrested and am being interrogated, what do I do? They say if I don't cooperate they are going to make things hell for me and put me in a holding cell with a bunch of gang members! But if I confess they will make things very easy for me.

Ask for your lawyer. If they don't immediately stop questioning you, continue asking for your lawyer. You don't ever want to say anything to cops. Even if they put you in a holding cell full of gang members, it is probably better to be there for a day than to confess and get sent with the same gang members for ten years. Anyways, most gang members are unlikely to mess with you if you just keep to yourself and don't cause any trouble with them. Keep in mind: police lie, secret service lie, they want you to confess, confessing or giving any information up is going to hurt you it is under no circumstances going to ever help you.

If I ask a cop if they are a cop, they have to tell me right?

No, cops do not have to tell you they are cops, neither do secret service. Undercovers lie all the time. So do confidential informants. Be careful who you trust, even friends you have known your entire life can turn.

But what about smoking weed or using other drugs? Can they do this too?

Undercovers can smoke weed, and I am sure they will have no issues using other drugs either. Someone using drugs does not mean that they are not a cop or secret service agent. It also doesn't mean they are not a confidential informant.

But I am non-important / don't do anything wrong / am small time

Even if you do nothing wrong, most LE wants to screw you. The majority of them are not trying to protect and serve, but are trying to meet some alpha male requirement they subconsciously have. They feel important when they bring you down. Also, people tend to minimize what they do, so you are probably bigger than you would like to admit. Be proud but silent of your achievements for the revolution.

When I talk online I like to say SWIM (someone who isn't me) instead of me or I. This keeps me safe right?

No, this offers you no protection at all. People who say SWIM are just fooling themselves. People tend to like to have "security blanket security" where they convince themselves they are safe as long as they do some simple ritual (as opposed to taking actual security precautions, which are a bit more difficult). Security blanket security is dangerous, as it doesn't offer real security but makes you act as if you are secured.

X. Modern Weapons Outline

Blunderbusses, and other homemade guns can be researched online, as well as slingshots and various low-tech „fool proof“ weapons. It is also possible to create basic projectile weapons and guns through experimentation, though care is to be taken when testing and using said guns as unrifled barrels or explosions in the firing chamber may prove highly dangerous. They fall outside of the scope of this guide due to their variety and abundance. Local factors and ammunition types are to be carefully considered when manufacturing or acquiring guns (projectile weapons) and ammunition (projectiles). In the SS Werwolf combat manual this is explained in detail. Other military manuals and gun manufacturing guides (such as: <http://archive.is/yAjQi>) can be acquired online or via associates who participate in related activities. Described in this Appendix are modern weapons which are not commonly found or mass produced. Additionally, explosives, molotov cocktails and swiss army knives are detailed.

Modern Weapons Shortlist

1) Microwave gun

This gun can be classified as a directed energy weapon. It is known colloquially as the „Poor man's Ray Gun“ as it is a simple microwave oven conversion. Microwave oven magnetrons are inexpensive and easy to manipulate, though extreme caution should be used as the voltages involved are lethal. A grounded understanding of electrical engineering is recommended before construction, though ultimately it is up to the risk tolerance of the individual to engage in the manufacturing of such a weapon. As with the Laser gun manual below, the intention should be to burn the enemy (or drone) to the death, not maim their eyesight. This should be done by aiming at the neck or head depending on the power of said beam. Skin will char so to achieve the desired lethal effect it is important to maintain aim. Alternatively, it can be used to seriously wound the enemy by targeting either exposed regions of skin, light clothing or grenades/explosives attached to their utility belt. Other longer wavelengths than the two mentioned, can be engineered in order to penetrate and boil enemies alive though the power consumption for this and potential for melting of components hinders the effectiveness of these weapons. Ultimately, it is up to the individual in order to determine the best radiation frequency and amplitude to employ in the field. **Caution and careful operation of such guns is vital to prevent loss of good will and morale among friendly forces.**

„Poor man's Ray Gun“ - Microwave oven conversion:

<https://www.yumpu.com/en/document/view/33249254/the-poor-mans-ray-gunpdf>

https://archive.org/details/Poor_Mans_Ray_Gun_David_Gunn_Desert_Publications

2) Laser gun

How to Make a Laser

WARNING: Lasers cause blindness or eye damage and, as with Microwave guns, using it near civilians or children is strictly forbidden and those who do so will be executed either by the enemy or by friendly forces.

First of all, let's review the Laser concept: L.A.S.E.R. stands for Light Emission by Stimulated Emission of Radiation. Lasers work, basically, like this:

1. A substance (usually a gas, although crystal lasers are made as well) is heated to the point where it begins to emit Photons. This substance is held in a tube.
2. The Photons reflect off mirrors on either side of the tube.
3. Eventually, the focused Photons will break through one of the mirrors and the actual laser beam will emit from the front of the tube.

Although Lasers are used in multiple types of light, we will be focusing on the Visible Spectrum. The Visible Spectrum of Light varies for each person, but generally extends from around 380 nm (Violet) to around 700 nm (Red). Red (600-700 nm) are some of the most common lasers. They are also some of the easiest to obtain.

Some recommended materials:

- 1-Adjustable Voltage Regulator LM317T
- 1- 100 ohm Potentiometer
- 2- 10 ohm Resistors
- 1- 1N4001 Rectifier Diode
- 1- 47uf 35v Capacitor
- 1- Any Size PCB Board
- 1- Any Solder
- 1- Any Soldering Iron
- 1- Power Switch (I like momentary push buttons)
- 1- 12x30mm Aixiz laser housing [Click Here](#)
- 2- Spools of wire (Red and Black)

You will need at least a 6 volt Power source.

You will also need something to put everything in when you are done. (a flashlight works if you can make the circuit small enough to fit in it) If you do not use a flashlight you will need some form of battery holder. Optional: Digital Multimeter (may be needed if you run into problems during construction or prototyping).

i) Laser Diodes

Laser Diodes are tiny. Creating them in a DIY setting is costly and time-consuming and they are usually manufactured by precision machines. Harvesting a laser diode can be a tricky process as they tend to be very fragile and sensitive to static and other forms of shock. It is very important to take your time in harvesting your precious diode. Do not ever drop it!

Below is an image of a Diode:

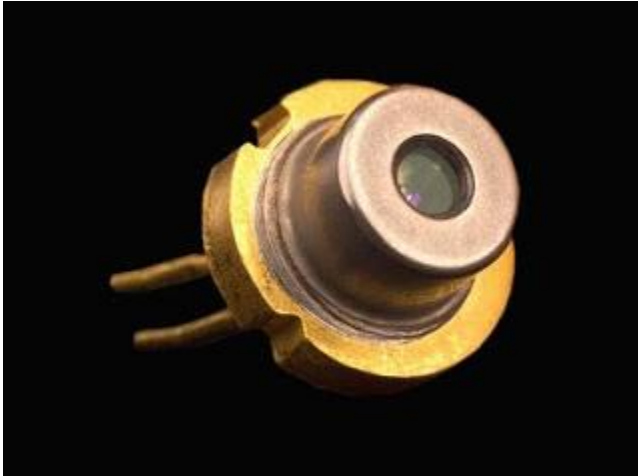

You will need an old DVD Writer. Blu-Ray works as well (you will have a violet laser instead of red, but it does work). You can extract one from an old computer. Also, the Writer must have AT LEAST 16X Writing Speed. If you use a Reader, or anything less than 16X Speed, you will end up with a weak red laser.

The first step in harvesting your laser diode is to disassemble your dvd drive. There will be 4 or more screws on the bottom side that you will need to remove.

Remove the plate on the back of the writer remove any circuit board under that until you see the sled.



Above: inside the drive

Right:
typical
drive,



Inside you will need to locate the laser assembly. It will be on 2 metal rails. At the ends of those rails will be more screws to remove. Once they are removed you will be able to lift the rails and slide the laser assembly right off.

On the right side of the page is a picture of the exact component you should be removing from your drive at this point.

You are done with the Writer now. It is recommended to preserve the 2-3 engines which you can find and remove from the corpse of the Writer.

Get the smallest screwdriver you can find. The sled consists of lots of small (very small) screws, usually glued in. Remove every screw you possibly can, some won't come out, but get most of them. Remove any parts you can. There will be TWO diodes, and they will not look like the above picture at first. There will be three pins on each one, with solder connecting them to something resembling a circuit board. They are attached to a small metal heat-sink and the lens on glass end will be

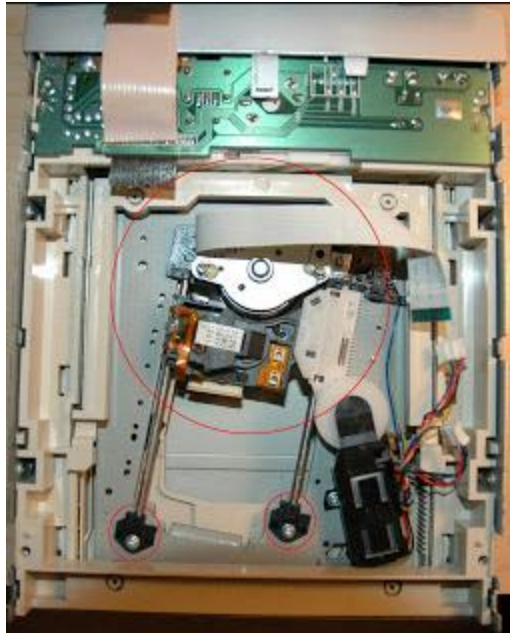

facing the series of mirrors and lenses focusing the beams to the center lens of the sled. The following procedure is VERY delicate.

You need Solder wick, a Soldering Iron, and Pliers. Place the Solder wick directly on top of the three pins. Heat up the wick and remove all of the solder off both of the diodes. Remove the circuit-board-like thing from the pins. BE CAREFUL, those pins MUST stay intact. The more you can keep on the better. Once

it is off (you may need to use forceps to wrestle it off, eventually it will come, just keep at it), you will need to remove the heat-sinks. There is an opaque glue connecting them to the sled. Insert your screwdriver (smaller the better) on the glue and pry it off. Try to go under the base on the glue. Once all 4 corners

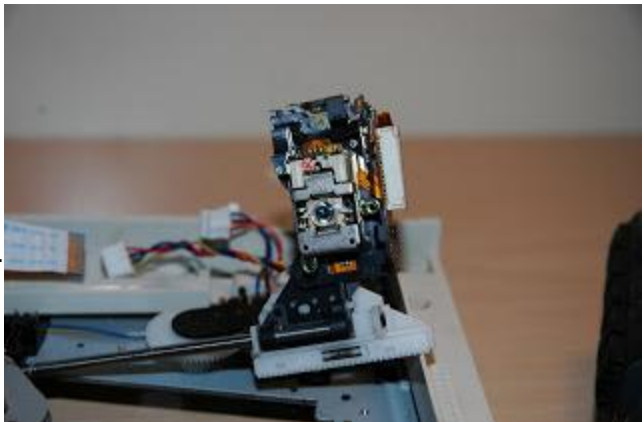

are off, remove the heat-sink/diode. Get both of them off.

Now, this is the hardest part. If you are doing it right, it still seems like you are going to break the diode. Do not be afraid, but do not be reckless either. Take your pliers in your hand. You may need wire cutters. Press down on the heat-sink on one of the sides. If you need a vise or other support, use it. Eventually, the heat-sink will split in half and the diode will pop off.

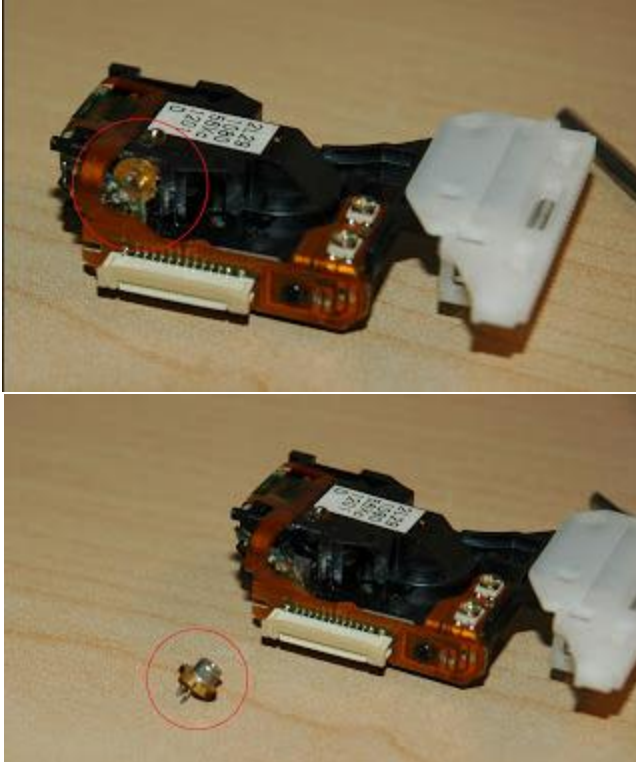

You will have to pry the diode out. It may be easier to remove the whole part that the laser is encased in, it is usually a metal heat sink of some sort. After you do that you can use pliers to hold the metal part and use wire cutters or another pair of pliers to pry it away from the diode. In some cases you will get lucky and the diode will pop right out very easily without anything else.

Be careful the diode is fragile!

Once the diode is out, you will need to solder the ribbon or whatever is soldered on to it.

When that is done take your diode and place it somewhere safe and static free. If you have bought any pc components recently they probably came in a static protective bag. if you have one you can store your diode in it for extra safety. Ideally you would want to use an anti static wrist band while removing and handling the diode. But don't worry too much about it if you don't have one.

ii) Control Circuit

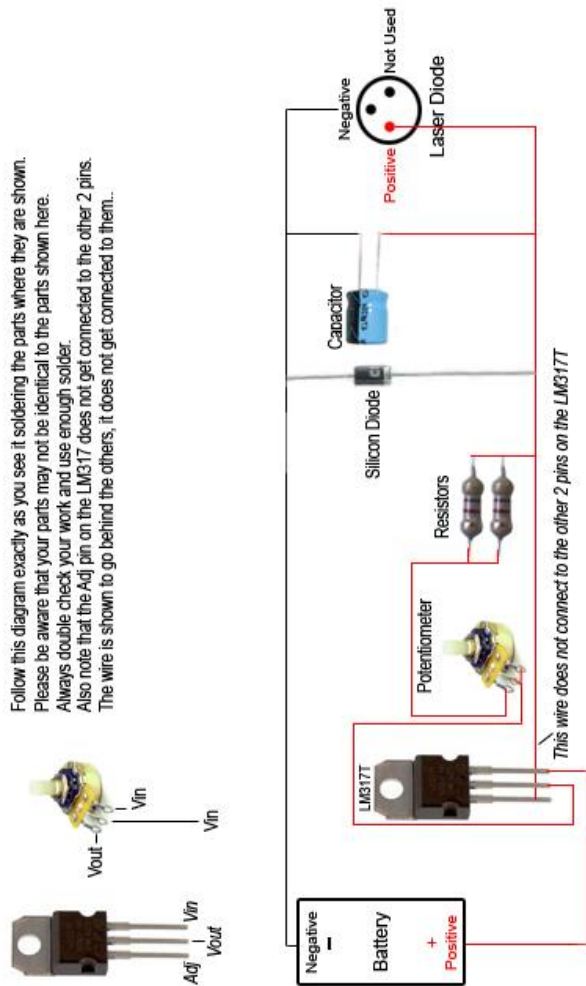

http://showyouhow.blogspot.com/2007/12/diy-dvd-burner-laser-pointer-proper-way_18.html

Although it can technically be done, do not "direct drive". Direct driving involves hooking up a diode directly to a battery or other power source. This will usually kill your diode. Thus, you will need a circuit to regulate your power.

You will need the following parts:

- 1) LM317T
- 2) Switch (Any will work, I used a switch but a button works equally well)
- 3) Potentiometer, 100 ohm (It can vary, but keep on track as much as possible)
- 4) 10 ohm resistors (You need two of these)
- 5) Board (PCB Boards work excellent for this)
- 6) Wire
- 7) 47uf35v Capacitor
- 8) 1N4001 Rectifier Diode
- 9) 5/6 Volt Power Source

You will also of course need more solder and your trusty soldering iron.

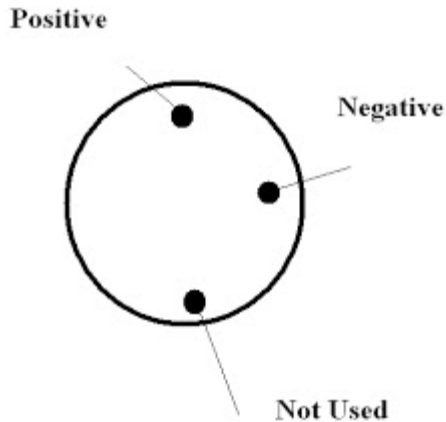

Now, let's first look at the laser diode itself.

Align the pins as shown and identify each one. Place the LM317T face up on the table. The far left pin needs to connect to the POSITIVE laser diode pin, but do not do the diode connection until last. Along the way it needs to connect to the 2 Resistors, the Capacitor, and the Rectifier Diode.

Lay your potentiometer face up with the pins facing you. The middle pin of the LM317T needs to connect to the far right AND middle pins of the potentiometer. Then, connect a wire from the left potentiometer pin too the other end of the two resistors.

Connect the last (right) to the POSITIVE end of the batteries. Lastly, run a wire from the negative power end to the negative diode pin, connecting to the capacitor and rectifier diode along the way.

Connect a Switch either on the main positive or negative rail.

Is your circuit finished? Great! Now we need the 6 Volt power source.

I used a Battery tray with 4 D batteries, but you can even use an old.

Computer power supply if you want (although that may require extra modification). Pick up a Project Box (You know, the plastic black boxes with screws in the corners.) Make sure it is big enough to fit your entire Circuit.

Connect the wires leading from the D Batteries to their respective positions. **DO NOT PUT BATTERIES IN YET.** This is just an added safety precaution, and I never have the batteries in my laser when it's not in use, even when off.

Take the project box and **drill two holes in the top**: One for the potentiometer and one for the switch. Make sure they fit snugly. Insert the parts into the holes you drilled and screw them in with the parts it came with. You probably need a wrench for this. Make sure they are in tightly.

Do not enclose it with a lid until you have verified it works (DO NOT turn it on.) It is at this point where you are most likely to ruin your diodes so BE CAREFUL.

Take your soldering iron and solder the positive wire to the positive pin and the negative wire to the negative pin. Again, be careful: Too much heat will snap the pins. Also, do not short out the circuit against the base of the diode. Apply it as fast as possible without rushing so as to not weaken the pins.

If you chose correctly and picked the red diode, you are done with the solder. If you chose the infrared, you will to remove it and place the red diode instead. And there is only one way to tell. Test it! Do you have Laser protection glasses? They need to be the kind that can resist the type of light the red diode is emitting (600-700 nm). This testing process is described in more detail below.

SAFETY WARNING!

1. If you do not use glasses, you are an idiot and should not be building a laser. These things BLIND you. How would you feel never seeing again, EVER? Wear protection glasses.

2. NEVER stare directly into the laser diode. This could blind you even with the glasses on.

Please go up and memorize the two safety steps.

Now you will need a **Laser Module**. A company called AixiZ makes these, or you can just buy on EBay, whichever is cheaper. If you don't know, a module is a small shiny tube that holds the diode. It also contains a lens to focus the laser. They generally cost around \$5.

Once your module arrives, do not do anything with it. We have **testing** to do. Take your circuit connected to the diode along with the 4 D Batteries (Not in the tray). Go into a small, dark room (lock on the door is best so someone doesn't accidentally walk in and damage their eyes) and set up a piece of white paper against the wall. Make sure the switch is off. Put your goggles on, and point the diode at the paper. Flip the switch.

If you see a red glow on the paper, you are set! Of course it will not burn anything yet, it isn't focused. If you see nothing, move the paper closer. If you see a

faint white dot, turn it off! You did not choose wisely and rigged the Infrared. If this happens to you, remove the infrared diode and solder the other one into place.

If you see nothing, nothing at all, it could be one of two things. It could just be the infrared, or it could be that your circuit is wired wrong. Double check everything. If you need too, use a Voltmeter to detect if your circuit is indeed running.

Is your red diode glowing brightly? Excellent. Utilize the potentiometer at this point to fine-tune the system. Now, turn off the circuit and remove one or more batteries, just in case. You will need to obtain a vise and your module. Flip the back end of the diode and place the small hole over the diode so that the pins are sticking out. Place the other module section with the small hole over the pins.

Push it together with the vise (keep it straight!) until the diode is snug inside the lens section of the module (the small end). Chop the wires connecting your diode to the rest of your circuit in half and slip the wires through the small hole in the back of the module. Screw the module back together so that the wires are leading out of the hole. Now, solder the wires back to the circuit and wrap electrical tape around the soldered part. Make sure everything is ready. IT'S TIME!!!

Replace your goggles and make sure that nobody will walk in and accidentally look at the laser.

Put the D Batteries back in, and flip the switch. If all went well you should have a laser! Now, turn the lens to focus the laser. Move the paper close and far to find the point where the point the laser makes is smallest. Place a match in that spot and it will burn.



Above: an example laser system without casing

Additional devices and EM based gadgets: <https://diymaketechnology.blogspot.com/2012>

3) Railgun (copper coil gun)

1) The Theory

A railgun is a device that uses electromagnetic forces to accelerate projectiles to high velocities. A strong pulse of electricity is sent through a pair of parallel rails, generating a magnetic field that accelerates a conducting projectile to speeds sufficient to send it high into the atmosphere. With only a little further rocket assistance, small payloads may eventually be orbited in this way at relatively low costs.

As with many technological concepts, the notion of using a large gun to fire an object directly into orbit dates back to Jules Verne. By the late 19th century this notion had already been considered in the electromagnetic format that the railgun was to assume, but no large-scale project devoted to the concept got under way until the 1970s. In the 1980s the railgun became part of the U. S. Strategic Defense Initiative (SDI).

Although the SDI program declined, researchers continue to work on electromagnetic launchers. In the simplest railgun design, an electric current passes up one of two parallel rails, through a metal armature (a cylinder around the projectile), and down the other rail. The magnetic field thus generated sends the armature down the gun while in contact with the rails. As the projectile exits, the armature falls to the ground. One problem with the railgun is that the contact between rails and projectile heats the air so much that a plasma is produced, softening the rails. A more complex version called a coilgun uses a series of metal coils to which electric current is applied sequentially, producing magnetic pulses along the entire length of the gun. In addition, the projectile is suspended magnetically and does not touch the coils.

A coil gun works on the principle of electromagnetic attraction. The coil gun itself is akin to an air cored solenoid. A ferromagnetic armature is placed at the breach of the coil and is electromagnetically attracted towards the centre of the coil when a current is passed through the coil. When the armature reaches the centre of the coil it will start actively decelerating if the current is still passing through the coil as it is magnetically attracted to the midpoint of the coil. This means that the current pulse length needs to be of a finite length in order for the armature to be accelerated up to the centre of the coil and not 'sucked back' as it tries to leave the coil via the other end. This is more specifically a 'reluctance coil gun', a diagram is shown below.

This is the biggest disadvantage to coil guns, the current pulse length needs to be controlled in order to cut the power when the armature reaches the middle of the coil.

The second largest challenge to overcome with coil guns is delivering the electricity as quickly as possible. It stands to reason that the more energy you can put onto the coil gun, the more energy will be transferred into kinetic energy in the armature.

The main losses in this system are the eddy currents in the flyway tube and the projectile/armature, these can be minimised by slotting the flyway tube or using a non-conductive material. The projectile must be ferromagnetic thus this

means that limiting eddy currents cannot be achieved by using a non-conductive material. The best solution to this is to use a powdered Iron in epoxy resin matrix. Although this improves initial efficiency it also removes the ability for the gun to be operated as an 'inductance coil gun'.

2) Things to Consider When Designing

The answer to what is probably your first question is yes. It is possible to make an automatic coil gun. <http://www.imageri.org/automatic-coil-gun/>

i) Projectiles

For further physics and test results regarding the projectiles please consult the following guide:

<https://www.instructables.com/id/Coil-Gun-Projectiles/>

<https://archive.fo/9Ckdg>

ii) Coil Length

The longer the coil is the more time it has to drag the projectile to the centre and the more wraps of wire can be fitted into the solenoid increasing magnetic flux density. The longer the piece of wire the coil is made of and the higher the inductance of the coil the higher the reluctance of the coil is so the longer the current pulse length will be. This means that the rate of change of current is lower and so will not reach as high a peak value. Since the current effects the magnetic field density a high current is desirable so the coil should be tuned so that it makes the strongest magnetic field in the time available.

The coil length is directly linked to the projectile length as they should be roughly equal as mentioned previously.

iii) Number of layers in the coil

More layers mean a stronger magnetic field but it also means higher impedance and so a longer pulse length. If the pulse length is too long then the projectile will experience "suck back" and have a lower exit velocity, optical triggering can be used to solve this problem.

Too many layers will mean that the magnetic field of the outer layers adds no strength the magnetic flux density in the centre where the projectile is and so the energy is wasted. It also means that the pulse length is unnecessarily long so the current will not rise as sharply as otherwise possible.

iv) Thickness of coil wire

Thicker wire means lower impedance so a faster pulse length and higher peak current. This means less wraps in the coil per unit area so the flux density is potentially reduced if the current isn't significantly increased by the lower impedance. If the wire is too thin it will have too high a resistance and get unnecessarily hot. In extreme cases it can burn out on firing.

v) Pulse Length

The pulse length should be exactly the same length as the amount of time it takes to pull the projectile from the breach to the centre of the coil and return to zero. The pulse length is affected by a myriad of variables including, capacitor voltage,

capacitor capacity, circuit resistance, and coil inductance which varies dynamically during use as there is initially an air core which is soon replaced with an iron core as the projectile slides in not to mention depending on how many turns, layers and what gauge of wire is used.

This problem is solved by fixing as many variables as possible such as capacitor voltage and size, projectile dimensions which in turn fix the coil length and internal diameter. Then the remaining variables are varied until the optimal combination is found. The remaining variables are most importantly wire gauge and number of layers. Assuming a suitable switch can be used the wire gauge is usually the largest available.

vi) Switch bounce/resistance

Mechanical switches can arc and bounce which lengthens the pulse and lowers the average flux density experienced in the tube during firing. This is overcome by the use of solid state switches such as SCR's, MOSFET's or IGBT's which experience none of the arcing issues. They are not perfect solutions though as they have several flaws such as requiring a switching current/voltage to work and SCR's cannot be switched off until the source-drain current drops below zero so require "v-switching". V-switching is where a second SCR and cap bank of the same or higher voltage is discharged through the first SCR dropping the voltage below zero and switching the switch off.

MOSFET's are generally quite low power so are of no use to coil guns of a decent scale and a suitable one can be expensive but a solution is to use a bank of them in parallel to spread the current over several less expensive devices. IGBT's are much better solutions as they can be switched on and off at will and can handle far higher power than MOSFET's. It is also important that the solid state switch can operate fast enough to turn the device on and off in the desired time frame, Most IGBT's are capable of this as well.

vii) Capacitor Voltage

The higher the capacitor voltage the higher the projectile velocity since the stored energy in a capacitor is equal to half the capacitance multiplied by the voltage squared as long as the switching capabilities are there then this is one of the more favourable variables to choose to increase as each extra volt makes a big difference.

viii) Capacitor Capacitance

The higher the capacitance the larger the volume of stored energy in line with:

$$\text{Energy stored in a capacitor} = 1/2 CV^2$$

4) Coil Flux Linkage (external Iron)

Adding an external iron shell to the coil can improve the flux linkage between the coil and the projectile but care must be taken to eliminate Eddy current losses. A powdered iron matrix or ceramic ferrite is therefore the best option. The External iron must not have too much mass as the extra iron material will slow the magnetic flux build up and the coil gun may not saturate as not all of the ferrous material is magnetised which means it is dead weight and just slows the flux

density increase rate. This would mean that the magnetic flux would not increase as rapidly and not reach as high peak value. Too little ferrous material means it is potentially wasting the magnetic flux available.

The External iron must therefore be optimised so that it does not saturate and yet there is enough to enhance the magnetic flux density. It will affect the inductance of the coil and so the current pulse length so the coil may need to be of a slightly different shape to gain optimal performance.

i) Minimise connecting wire length

All connecting wires between the coil and the capacitors should be as short and thick as possible to reduce resistive losses and inductance.

5) The Design

i) Capacitor bank size

A bank of 40 330v photoflash capacitors of 100uF capacity where used giving a total energy capacity of 217.8J:

$$E = 1/2 CV^2$$

$$E = 1/2 * 4000 * 10^{-6} * 330^2$$

$$E = 217.8J$$

ii) Switching

Only solid state switches would work for this project as any other switches would arc. I was supplied with an IGBT capable of handling up to 1200V and 800A Peak and a maximum full switching on and off time of 1300ns. This is fast enough and can handle far more volts than needed but the current is only just enough. It switches at up to +/- 20v.

iii) Charging

A 1.5v to 400 volt inverter has been included in the enclosure to enable the device to be charged of AA batteries but this would be slow and would use several batteries per shot. The main charging comes from half rectified mains using a light bulb as a charging resistor to give non-linear resistance through the charge cycle. UK mains electricity is 240v RMS, which when half wave rectified using a diode comes out at 336v. My capacitors charge up to 330 volts so 336 is perfect and mains will allow me to charge the bank cheaply and quickly when compared to the battery solution. A resistor was placed across the capacitor bank to slowly discharge it to make sure it is always left uncharged.

iv) Voltage Monitoring

A simple voltmeter has been mounted to the enclosure so that the voltage on the capacitor bank can be monitored in real time to check the charge state and double check prevention of overcharging. Coilguns deal with the precision timing, magnetic saturation of the projectile, and spacing needed between the coils for maximum efficiency.

v) Projectile dimensions

Through trial and error and parameter sweeps I found the optimum set up for several different diameters of projectile. The important results are below; all were limited to roughly 800Amps so my IGBT could handle the current.

6mm Diameter

The standard 6mm coil gun with the predetermined limits from above would give a rough maximum of 33.5m/s and 3.6J kinetic energy on 15 layers of 14AWG 30mm length. The capacitor bank was so large this was evidently too much power to dump into such a small projectile in one stage. The projectile size was too small and a larger projectile was needed. The simulation graph is below

10mm Projectile

Using a 10mm projectile it was found that a 40mm length coil would be best using 10 layers of wire and producing 25.4m/s but a more reasonable 7.6J of kinetic energy.

12mm Projectile

Using a 12mm projectile an optimum length of 45mm was found with 9 layers of 14AWG. This gave a velocity of 22.7m/s and a kinetic energy of 9.9J with a peak current of 811Amps.

15mm Projectile

Using a 15mm projectile an optimum set up was found to be 7 layers of 50mm length 14AWG. This gave a velocity of 16.65m/s and a kinetic energy of 9.15J. This was less than the 12mm so the 12mm was used.



More details can be found at: <https://www.instructables.com/id/Coil-Gun-Projectiles/> <https://archive.fo/9Ckdg>

Note: a 9mm bullet fires at 380m/s with 540J of kinetic energy. For an effective weapon increase the current through the coil and increase its length. The best material in a coil gun is one with the optimal balance between mass and its magnetic saturation point.

4) Heart attack gun (with optional umbrella enclosure)

This gun is used for stealthy assassination missions. It shoots a poison pellet or other poison contained within a projectile. It is also called the „Bulgarian Umbrella“. A Bulgarian umbrella is an umbrella with a hidden pneumatic mechanism which injects a small poisonous pellet containing ricin. It has a hollowed stalk into which the pellet neatly sits.

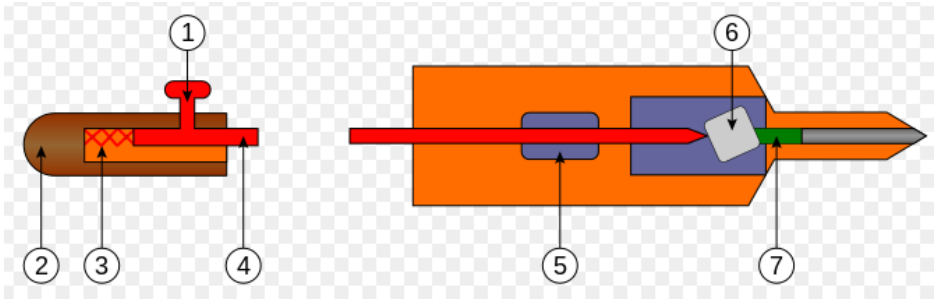

This is a basic schematic thereof:

This is a diagram of the firing mechanism of the umbrella used to assassinate Bulgarian dissident Georgi Markov. The trigger is in the umbrella handle, the umbrella handle pushes a spring which pushes the linkage system. The linkage system links the trigger to the valve of the Cylinder of compressed air. The switch then activates the valve. The valve fires the ricin (or other poison) pellet through the 'barrel' of the umbrella.

Learning from Past Failures (1980's) using this Tactic

„The plot was described by Trevor Floyd, a member of the innocuously-named **Civil Co-operation Bureau (CCB)**, a <South African> defence force hit-squad. The targets were Dr. Pallo Jordan, an MP and a former minister in Nelson Mandela's Cabinet, and South Africa's Minister of Water Affairs and Forestry, Ronnie Kasrils. And the proposed murder weapon was an umbrella.

Mr Floyd told the court that, having read of a similar ploy used by Bulgarian assassins to kill the dissident BBC World Service journalist Georgi Markov, he decided to use an umbrella to fire darts laced with poison. Having been given the go-ahead by his boss, CCB's "managing director", Colonel Joe Verster, he duly acquired an umbrella from Europe, presumably to prevent the killer being traced to South Africa.

Mr Floyd, a self-confessed State killer, said he was instructed to fly to London, where he would be given the umbrella after its transformation.

He duly linked up in Britain with a man who had identified himself as Jan Lourens, a Special Forces agent, and who was to supply him with the umbrella. **They drove to a farm that Mr Lourens said was used by people including Dr Basson while they were in England.**

Mr Floyd told Mr Justice Hartzenberg: "He went into the house and brought the gadget out. When you pressed it against skin, the spikes shot into the

body and, if filled with the poison substance, they could be deadly."

It was then that the assassination bid started coming off the rails. **As Mr Lourens demonstrated how to use the umbrella, some of the poison spilled onto his finger.** Mr Floyd said: "I thought he was going to die. I told him to drink milk and to lie down for a while because I did not know the area and I would not be able to rush him to hospital." But Mr Lourens felt fine after about 10 minutes.

Armed with his umbrella, Mr Floyd set off back to London. He soon found he had another problem - **the killing attachment made the umbrella too long and there was a real danger of the tip accidentally hitting the ground and dispensing its poison spikes prematurely.** So he carried out his **own modification, attaching the gadget to the umbrella with a "hair-curling tongs"**.

Now Mr Floyd was armed and in place. But the **intended victims were not.** Dr Jordan had moved and Mr Kasrils was not often "at his place". The plot was abandoned and **the umbrella thrown into the Thames.**"

<https://www.independent.co.uk/news/world/africa/how-an-assassin-bungled-a-deadly-umbrella-plot-276370.html>

We can identify multiple points of failure which the SS member must avoid:

- 1) The agent was ferried to a safe house which was in continuous use. Should he have had a tail then the **safe house would be compromised.**
- 2) A demonstration was bungled leading to the **accidental poisoning** of a team member.
- 3) The weapon was **poorly designed** and made in a hurried manner without prior testing.
- 4) The **attempts to repair it in the field were poor** and would have resulted in the identity of the assassin being compromised due to the incredibly obvious nature of the modification.
- 5) The **weapon was not properly disposed of.** Throwing it away into nearby nature is stupid, especially in a large city where such an action would attract attention. Clearly the agent was acting in frustration and not planning ahead.

The SS member is recommended to develop or utilize further designs in consultation with SS weaponry experts. A pretty, but ineffective and overly costly weapon is damaging to the overall war effort. It is much more efficient to mass produce simpler designs for your formation than spend months on a single prototype. The goal and usage of the weapons is to be considered: are they the correct tool for the job?

XI. Home-made explosives

In a perfect world the National Socialist would not need to manufacture bombs at home, however a perfect world must be forged through our Iron and Blood, which starts in the household.

1) Bomb making intro

Contents

- 1) Applied Chemistry
- 2) Bomb fuels
 - a) ROCKET ENGINE POWDER
 - b) RIFLE/SHOTGUN POWDER
 - c) FLASH POWDER
- 3) See also

1) Applied Chemistry

Bomb making is a topic many darknet people are very interested in, because with little effort and money some impressive devices can be made.

2) Bomb fuels

Gunpowder

Black powder is the mainstay of pyrotechnics. At a basic level it is a mixture of potassium nitrate, charcoal and sulphur. However, simply mixing these ingredients together will not produce proper black powder. It merely produces a much milder version, which itself is used extensively in pyrotechnics, and is commonly called meal powder.

True black powder takes advantage of the extreme solubility of potassium nitrate by mixing the very fine milled ingredients into a dough with water, then using strong compression to force the water out of the mixture, so that tiny crystals of potassium nitrate form in and around the particles of the other ingredients. This produces a product that is far fiercer than the simple meal powder.

a) ROCKET ENGINE POWDER

One of the most exciting hobbies nowadays is model rocketry. Estes is the largest producer of model rocket kits and engines. Rocket engines are composed of a single large grain of propellant. This grain is surrounded by a fairly heavy cardboard tubing. One gets the propellant by slitting the tube lengthwise, and unwrapping it like a paper towel roll. When this is done, the grey fire clay at either end of the propellant grain must be removed. This is usually done gently with a plastic or brass knife. The material is exceptionally hard, and must be crushed to be used. By gripping the grain on the widest setting on a set of pliers, and putting the grain and powder in a plastic bag, the powder will not break apart and shatter all over. This should be done to all the large chunks of powder, and then it should be crushed like black powder. Rocket engines come in various sizes, ranging from 1/4 A - 2T to the incredibly powerful D engines.

The larger the engine, the more expensive. D engines come in packages of three, and cost about \$5.00 per package. Rocket engines are perhaps the single

most useful item sold in stores to a terrorist, since they can be used as is, or can be cannibalized for their explosive powder.

b) RIFLE/SHOTGUN POWDER

Rifle powder and shotgun powder are really the same from a practical standpoint. They are both nitrocellulose based propellants. They will be referred to as gunpowder in all future references. Gunpowder is made by the action of concentrated nitric and sulfuric acid upon cotton. This material is then dissolved by solvents and then reformed in the desired grain size. When dealing with gunpowder, the grain size is not nearly as important as that of black powder. Both large and small grained gunpowder burn fairly slowly compared to black powder when unconfined, but when it is confined, gunpowder burns both hotter and with more gaseous expansion, producing more pressure. Therefore, the grinding process that is often necessary for other propellants is not necessary for gunpowder. Gunpowder costs about \$9.00 per pound.

c) FLASH POWDER

Flash powder is a mixture of powdered zirconium metal and various oxidizers. It is extremely sensitive to heat or sparks, and should be treated with more care than black powder, with which it should NEVER be mixed. It is sold in small containers which must be mixed and shaken before use. It is very finely powdered, and is available in three speeds: fast, medium, and slow. The fast flash powder is the best for using in explosives or detonators. See also:

<http://qx7j2selmom4ioxf.onion/files.html#new>

<http://parazite.nn.fi/roguesci/index.php/f-18.html>

THERMITE

Thermite is a fuel-oxidizer mixture that is used to generate tremendous amounts of heat. It is a mixture of iron oxide and aluminum, both finely powdered. When it is ignited, the aluminum burns, and extracts the oxygen from the iron oxide. This is really two very exothermic reactions that produce a combined temperature of about 2200 degrees C. This is half the heat produced by an atomic weapon. It is difficult to ignite, however, but when it is ignited, it is one of the most effective firestarters around.

MATERIALS

powdered aluminum (10 g)

powdered iron oxide (10 g)

1) There is no special procedure or equipment required to make thermite. Simply mix the two powders together, and try to make the mixture as homogenous as possible. The ratio of iron oxide to aluminum is 50% / 50% by weight, and be made in greater or lesser amounts.

2) Ignition of thermite can be accomplished by adding a small amount of potassium chlorate to the thermite, and pouring a few drops of sulfuric acid on it. The other method of igniting thermite is with a magnesium strip. Finally, by using

common sparkler-type fireworks placed in the thermite, the mixture can be ignited.

CORDITE

Materials:

Guncotton
Nitroglycerine
Acetone
Petroleum jelly

Procedure:

Cordite is a smokeless explosive - you take your guncotton, mix it with nitroglycerine, petroleum jelly and a little acetone and let it dry and then you have cordite! You can use it by itself or with other charges.

3) Pipe bomb/molotov etc **i) EXPLOSIVE CONTAINERS**

This section will cover everything from making a simple firecracker to

a complicated scheme for detonating an insensitive high explosive, both of which are methods that could be utilized by freedom fighters.

ii) PAPER CONTAINERS

Paper was the first container ever used for explosives, since it was first used by the Chinese to make fireworks. Paper containers are usually very simple to make, and are certainly the cheapest. There are many possible uses for paper in containing explosives, and the two most obvious are in firecrackers and rocket engines. Simply by rolling up a long sheet of paper, and gluing it together, one can make a simple rocket engine. Perhaps a more interesting and dangerous use is in the firecracker. The firecracker shown here is one of Mexican design. It is called a "polumna", meaning "dove". The process of their manufacture is not unlike that of making a paper football. If one takes a sheet of paper about 16 inches in length by



1.5 inches wide, and fold one corner so that it looks like this:
and then fold it again so that it looks like this:



A pocket is formed. This pocket can be filled with black powder, pyrodex, flash powder, gunpowder, rocket engine powder, or any of the quick-burning fuel oxidizer mixtures that occur in the form of a fine powder. A fuse is then inserted, and one continues the triangular folds, being careful not to spill out any of the explosive. When the polumna is finished, it should be taped together very tightly, since this will increase the strength of the container, and produce a louder and more powerful explosion when it is lit. The finished polumna should look like a 1/4 inch - 1/3 inch thick triangle, like the one shown below:



iii) METAL CONTAINERS

The classic pipe bomb is the best known example of a metal-contained explosive. Idiot anarchists take white tipped matches and cut off the matchheads. They pound one end of a pipe closed with a hammer, pour in the whitetipped matches, and then pound the other end closed. This process often kills the fool, since when he pounds the pipe closed, he could very easily cause enough friction between the match heads to cause them to ignite and explode the unfinished bomb. By using pipe caps, the process is somewhat safer, and the less stupid anarchist would never use white tipped matches in a bomb. He would buy two pipe caps and threaded pipe (fig. 1). First, he would drill a hole in one pipe cap, and put a fuse in it so that it will not come out, and so powder will not escape during handling. The fuse would be at least 3/4 an inch long inside the bomb. He would then screw the cap with the fuse in it on tightly, possibly putting a drop of super glue on it to hold it tight. He would then pour his explosive powder in the bomb. To pack it tightly, he would take a large wad of tissue paper and, after filling the pipe to the very top, pack the powder down, by using the paper as a ramrod tip, and pushing it with a pencil or other wide ended object, until it would not move any further. Finally, he would screw the other pipe cap on, and glue it. The tissue paper would help prevent some of the powder from being caught in the threads of the pipe or pipe cap from being crushed and subject to friction, which might ignite the powder, causing an explosion during manufacture.

An assembled bomb is presented in fig. 2.

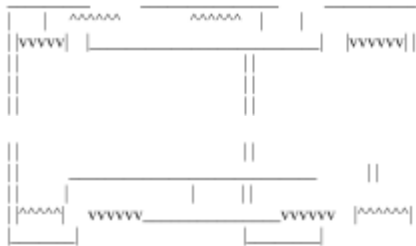

fig 1. Threaded pipe and endcaps.

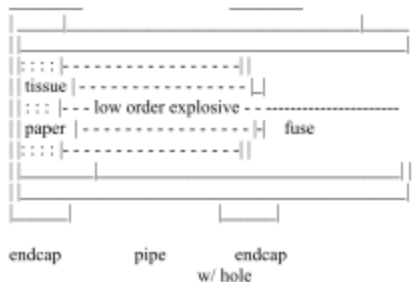

fig. 2 Assembled pipe bomb.

This is one possible design that a mad bomber would use. If, however, he did not have access to threaded pipe with endcaps, he could always use a piece of copper or aluminum pipe, since it is easily bent into a suitable position. A major problem with copper piping, however, is bending and folding it without tearing it; if too much force is used when folding and bending copper pipe, it will split along the fold. The safest method for making a pipe bomb out of copper or aluminum pipe is similar to the method with pipe and endcaps.



fig. 1 pipe with one end flattened and fuse hole drilled (top view)

First, one flattens one end of a copper or aluminum pipe carefully, making sure not to tear or rip the piping. Then, the flat end of the pipe should be folded over at least once, if this does not rip the pipe. A fuse hole should be drilled in the pipe near the now closed end, and the fuse should be inserted. Next, the bomb-builder would fill the bomb with a low order

explosive, and pack it with a large wad of tissue paper. He would then flatten and fold the other end of the pipe with a pair of pliers. If he was not too dumb, he would do this slowly, since the process of folding and bending metal gives off heat, which could set off the explosive. A diagram is presented to the right: A CO2 cartridge from a B.B gun is another excellent container for a low-order explosive. It has one minor disadvantage: it is time consuming to fill. But this can be rectified by widening the opening of the cartridge with a pointed tool. Then, all that would have to be done is to fill the CO2 cartridge with any low-order explosive, or any of the fast burning fueloxidizer mixtures, and insert a fuse.



fig. 2 pipe with one end flattened and folded up (top view)

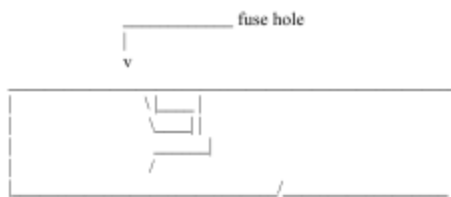

fig. 3 pipe with flattened and folded end (side view)

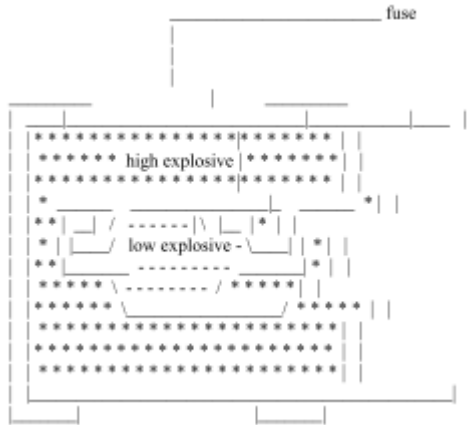

fig. 4 completed bomb, showing tissue paper packing and explosive (side view)

These devices are commonly called "crater makers". A CO2 cartridge

also works well as a container for a thermit incendiary device, but it must be modified. The opening in the end must be widened, so that the ignition mixture, such as powdered magnesium, does not explode. The fuse will ignite the powdered magnesium, which, in turn, would ignite the thermit.

The previously mentioned designs for explosive devices are fine for low-order explosives, but are unsuitable for high-order explosives, since the latter requires a shockwave to be detonated. A design employing a smaller low-order explosive device inside a larger device containing a high-order explosive would



probably be used. It would look something like:

If the large high explosive container is small, such as a CO2 cartridge, then a segment of a hollow radio antenna can be made into a low-order pipe bomb, which can be fitted with a fuse, and inserted into the CO2 cartridge.

iv) PLASTIC CONTAINERS

Plastic containers are perhaps the best containers for explosives, since they can be any size or shape, and are not fragile like glass. Plastic piping can be bought at hardware or plumbing stores, and a device much like the ones used for metal containers can be made. The high-order version works well with plastic piping.

If the entire device is made out of plastic, it is not detectable by metal detectors. Plastic containers can usually be shaped by heating the container, and bending it at the appropriate place. They can be glued closed with epoxy or other cement for plastics. Epoxy alone can be used as an endcap, if a wad of tissue paper

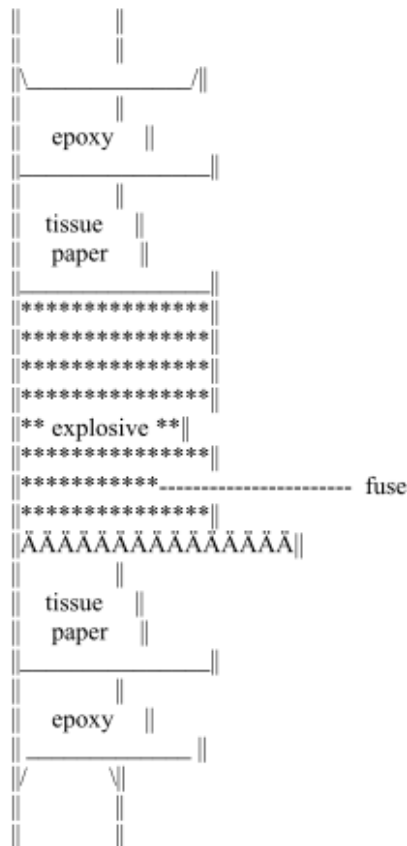

is placed in the piping. Epoxy with a drying agent works best in this type of device. One end must be made first, and be allowed to dry completely before the device can be filled with powder and fused. Then, with another piece of tissue paper, pack the powder tightly, and cover it with plenty of epoxy. PVC pipe works well for this type of device, but it cannot be used if the pipe had an inside diameter greater

than 3/4 of an inch. Other plastic puttys can be used in this type of device, but epoxy with a drying agent works best.

v) ADVANCED USES FOR EXPLOSIVES

The techniques presented here are those that could be used by a person who had some degree of knowledge of the use of explosives. Some of this information comes from demolitions books, or from military handbooks. Advanced uses for explosives usually involved shaped charges, or utilize a minimum amount of explosive to do a maximum amount of damage. They almost always involve high order explosives.

vi) SHAPED CHARGES

A shaped charge is an explosive device that, upon detonation, directs the explosive force of detonation at a small target area. This process can be used to breach the strongest armor, since forces of literally millions of pounds of pressure per square inch can be generated. Shaped charges employ high-order explosives, and usually electric ignition systems.

An example of a shaped charge is shown below.

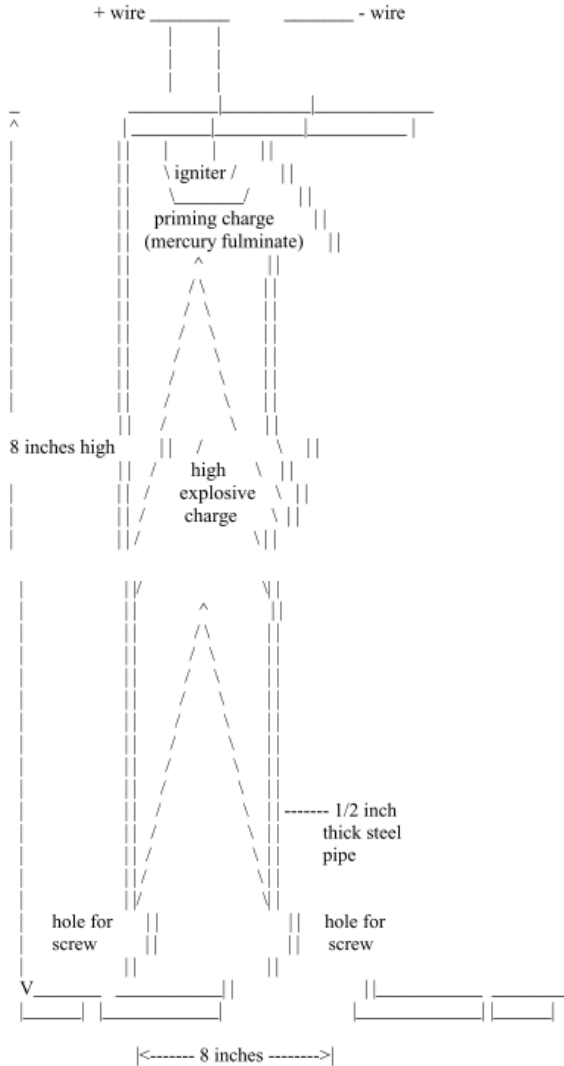

vii) TUBE EXPLOSIVES

A variation on shaped charges, tube explosives can be used in ways that shaped charges cannot. If a piece of 1/2 inch plastic tubing was filled with a sensitive high explosive such as R.D.X., and prepared as the plastic explosive container in section iv), a different sort of shaped charge could be produced; a charge that directs explosive force in a circular manner. This type of explosive could be wrapped around a column, or a doorknob, or a telephone pole. The explosion would be directed in and out, and most likely destroy whatever it was wrapped around. In an unbent state, a tube explosive would look like this:

When an assassin or terrorist wishes to use a tube bomb, he must wrap it around whatever thing he wishes to destroy, and epoxy the ends of the tube bomb together. After it dries, he/she can connect wires to the squib wires, and detonate the bomb, with any method of electric detonation.

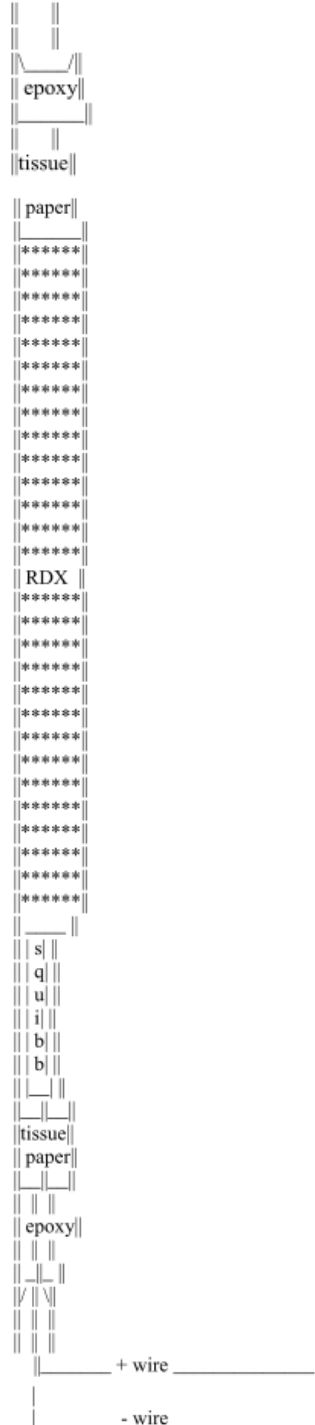

viii) MOLOTOV COCKTAILS

First used by Russians against German tanks, the Molotov cocktail is now exclusively used by terrorists worldwide. They are extremely simple to make, and can produce devastating results. By taking any highly flammable material, such as gasoline, diesel fuel, kerosene, ethyl or methyl alcohol, lighter fluid, turpentine, or any mixture of the above, and putting it into a large glass bottle, anyone can make an effective firebomb. After putting the flammable liquid in the bottle, simply put a piece of cloth that is soaked in the liquid in the top of the bottle so that it fits tightly. Then, wrap some of the cloth around the neck and tie it, but be sure to leave a few inches of loose cloth to light. Light the exposed cloth, and throw the bottle.

If the burning cloth does not go out, and if the bottle breaks on impact, the contents of the bottle will spatter over a large area near the site of impact, and burst into flame. Flammable mixtures such as kerosene and motor oil should be mixed with a more volatile and flammable liquid, such as gasoline, to insure ignition. A mixture such as tar or grease and gasoline will stick to the surface that it strikes, and burn hotter, and be more difficult to extinguish. A mixture such as this must be shaken well before it is lit and thrown.

Special care must be taken to maintain good will and support of the local populace. Remember: the term terrorist should be reserved for Leftists. We are freedom fighters.

Homemade Molotov Cocktails

USING HOMEMADE NAPALM

YOU WILL NEED:

A Funnel
Wax Soap or Candles
A Gallon of Gasoline
Glass Bottles(any size)
Duct Tape
Dry Rags
Potato Peeler
Some Bowls

STEP 1

Peel off small shavings from your soap/candle using a potato peeler. Make them fingernail-clipping sized or smaller!



STEP 2

Put a quarter-gallon of gasoline into a 3-gallon(or larger) container. Stir in wax shavings until the mixture sticks to your fingers like a sort of glue. If you mix in too many shavings, the mixture won't spread when thrown. Too few, it won't stick.

STEP 3

Using a funnel, pour the mixture into your bottles, filling them about 80% capacity. Yes, it's sticky and hard as hell to get through the funnel, but use a thin utensil to push it through and deal with it.

STEP 4

Take just about anything(A cork, bottle-lid, old fabric) and cork the bottle tightly. Go over the cork with duct tape, and be thorough! You do not want this to open up while lighting it!

STEP 5

Take a large, dry rag and tear it up into 2' x 6" sheets. Tie one end of these sheets to the neck of the filled bottle, and secure it using duct tape(glue works if you have any handy). Leave about a foot of rag hanging off of the bottle.

STEP 6



Light the rag on fire and throw it at a hard surface. The bottle will break open and the napalm will catch on fire, while sticking to anything it comes in contact with. For this reason, don't throw it at anything you do not want to see erupt in flames.



Further designs can be found in the „Terrorist's Handbook“ by Gunzenbomz Pyro-Technologies, a division of Chaos Industries (CHAOS).

2. Swiss army knife blueprint

No modern fighter is complete without a Swiss Army Knife, also referred to as a Multitool. It is recommended to acquire a Victorinox Spartan or Deluxe Tinker. In lieu of these a simple guide for DIY construction of your own Swiss Army Knife (different attachments approximated as keys) is included below, the SS member is recommended to creatively work around resource limitations relating to tools and materials:

i) Materials

- 1) Two pieces of wood (about 1" x 3.75" x 1/8" each)
- 2) Thin sheet metal (about 2" x 3.75")
- 3) Two #8 machine screw lock nuts
- 4) Two #8 machine screws, 3/4" long
- 5) Ten #8 machine screw washers
- 6) Glue that's able to bond wood to metal
- 7) Wood stain (optional)
- 8) Polyurethane (optional)

ii) Tools

- 1) Drill and bit set
- 2) Tin snips
- 3) Sand paper/sanding block
- 4) Small binder clamps
- 5) Pencil
- 6) Ruler

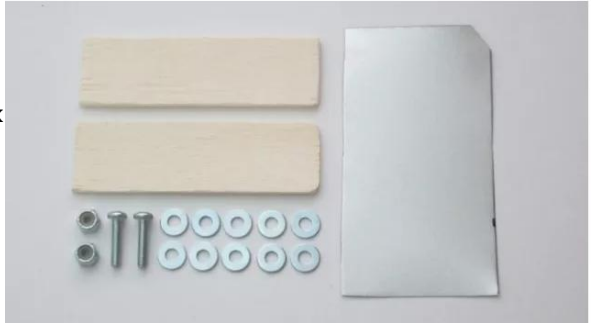

Tip: Paint stir sticks are a good size to be used for the wood pieces. These are generally free at the paint section of most hardware stores. For the sheet metal, I used a baking sheet that I found at Dollar Tree for \$1. This yields about 13" x 9" of metal.

iii) Cut the Wood and Metal to Shape

Use whatever rounded object you have readily available to trace a semicircle onto each end of the wood pieces. Then using a saw or knife, cut along the outline. Trace the shape of these wood pieces onto the sheet metal. Using a pair of tin snips

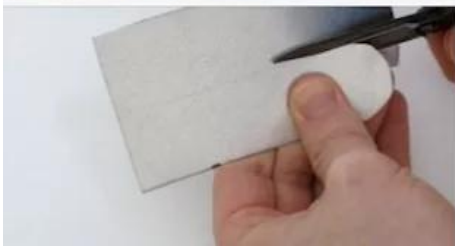

cut out two pieces of sheet metal that are a little smaller than the outlines.

iv) Drill the Bolt Holes

Make a stack of the two wood pieces and the two metal pieces. Make sure all the pieces are centered, and hold them together with a binder clamp. Mark the centers of the semicircle on each end. They should be about 2.75 inches apart. Using a 3/16 drill bit, drill through all four layers at one of these points. Insert a screw into this hole to help keep the layers lined up. Then drill the second hole. Remove the two metal pieces and re-drill the holes in the wood pieces so that the holes are wide enough to accommodate the head of the machine screw and the lock nut respective. You may wish to wrap the wood pieces in tape to prevent them from splitting when drilling larger holes. When you're done cutting and drilling, sand all

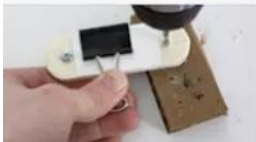
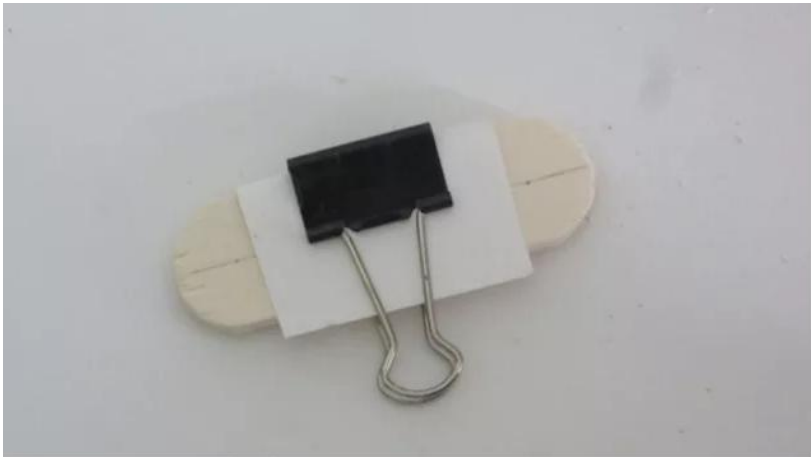

the surfaces and edges smooth.

v) Assemble the Frame

Insert the machine screws through the holes in the metal plates. Then add the washers and keys. Four keys and five washers will fit perfectly on a 3/4-inch screw in the sequence (sheet metal, washer, key, washer, key, washer, key, washer, key, washer, sheet metal). Using this sequence, two keys and three washers will fit on a 1/2-inch screw. Likewise, six keys and seven washers will fit on a 1-inch screw.



Alternatively, you can conserve space a little bit by eliminating the washers, but the keys will tend to stick on each other. If you have an odd number of keys you can fill the space with two washers. When you're done adding keys and washers, add the second piece of sheet metal. Then, tighten everything together with the two lock nuts.



vi) Glue the Wooden Panels

Apply a thin layer of glue to the outside of one plate and press on the wooden panel. Do the same for the second panel, then use binder clips to hold everything in place while the glue dries. You may wish to add a layer or two of card stock to prevent the clamps from denting your wood panels.



Victorinox Spartan.



Victorinox Deluxe Tinker.

XII. Enemy Tactics and Guerrilla War

War Tactics of the Enemy

This section was based on the Brazilian-communist war tactics which saw success in the 70's. **Tactics are adapted to the Brazil's environment** - this must be considered. Clear differences and yet large similarities are apparent. The largest difference occurs in the war philosophy of each individual fighter, or rather the lack thereof, especially from the ethical and leadership perspective, of the leftists. On the other hand it is helpful to learn the bulk of these tactics off-by-heart in order to improve your own war effort and to encircle, lure and destroy the enemy in the field.

1. Minimanual of the Urban Guerrilla by Carlos Marighella

Contents

See also: http://kpvz7ki2lvnwve7.onion/wiki/index.php/Main_Page

- 1) A DEFINITION OF THE URBAN GUERRILLA
- 2) PERSONAL QUALITIES OF THE URBAN GUERRILLA
- 3) HOW THE URBAN GUERRILLA LIVES
- 4) TECHNICAL PREPARATION OF THE URBAN GUERRILLA
- 5) THE URBAN GUERRILLA'S WEAPONS
- 6) THE SHOT; THE URBAN GUERRILLA'S REASON FOR EXISTENCE
- 7) THE FIRING GROUP
- 8) THE LOGISTICS OF THE URBAN GUERRILLA
- 9) CHARACTERISTICS OF THE URBAN GUERRILLA'S TACTICS
- 10) THE INITIAL ADVANTAGES OF THE URBAN GUERRILLA
- 11) SURPRISE
- 12) KNOWLEDGE OF THE TERRAIN
- 13) MOBILITY AND SPEED
- 14) INFORMATION
- 15) DECISIVENESS
- 16) OBJECTIVES OF THE GUERRILLA'S ACTIONS
- 17) ON THE TYPES AND NATURE OF MISSIONS FOR THE URBAN GUERRILLA
- 18) ASSAULTS
- 19) THE BANK ASSAULT AS POPULAR MISSION
- 20) RAIDS AND PENETRATIONS
- 21) OCCUPATIONS
- 22) AMBUSH

- 23) STREET TACTICS
- 24) STRIKES AND WORK INTERRUPTIONS
- 25) DESERTIONS, DIVERSIONS, SEIZURES, EXPROPRIATION OF AMMUNITION AND EXPLOSIVES
- 26) LIBERATION OF PRISONERS
- 27) EXECUTIONS
- 28) KIDNAPPING
- 29) SABOTAGE
- 30) TERRORISM
- 31) ARMED PROPAGANDA
- 32) THE WAR OF NERVES
- 33) HOW TO CARRY OUT THE ACTION
- 34) SOME OBSERVATIONS ON TACTICS
- 35) RESCUE OF THE WOUNDED
- 36) GUERRILLA SECURITY
- 37) THE SEVEN SINS OF THE URBAN GUERRILLA
- 38) POPULAR SUPPORT
- 39) See also

1) A DEFINITION OF THE URBAN GUERRILLA

The urban guerrilla is a person who fights the military dictatorship with weapons, using unconventional methods. A revolutionary and an ardent patriot, he is a fighter for his country's liberation, a friend of the people and of freedom. The area in which the urban guerrilla operates is in the large Brazilian cities. There are also criminals or outlaws who work in the big cities. Many times, actions by criminals are taken to be actions by urban guerrillas.

The urban guerrilla, however, differs radically from the criminal. The criminal benefits personally from his actions, and attacks indiscriminately without distinguishing between the exploiters and the exploited, which is why there are so many ordinary people among his victims. The urban guerrilla follows a political goal, and only attacks the government, the big businesses and the foreign imperialists.

Another element just as harmful to the guerrillas as the criminal, and also operating in the urban area, is the counterrevolutionary, who creates confusion, robs banks, throws bombs, kidnaps, assassinates, and commits the worst crimes imaginable against urban guerrillas, revolutionary priests, students, and citizens who oppose tyranny and seek liberty.

The urban guerrilla is an implacable enemy of the regime, and systematically inflicts damage on the authorities and on the people who dominate the country and exercise power. The primary task of the urban guerrilla is to distract, to wear down, to demoralize the military regime and its repressive forces, and also to attack and destroy the wealth and property of the foreign managers and the Brazilian upper class.

The urban guerrilla is not afraid to dismantle and destroy the present Brazilian economic, political and social system, for his aim is to aid the rural guerrillas and to help in the creation of a totally new and revolutionary social and political structure, with the armed population in power.

2) PERSONAL QUALITIES OF THE URBAN GUERRILLA

The urban guerrilla is characterized by his bravery and his decisive nature. He must be a good tactician, and a good marksman. The urban guerrilla must be a person of great cleverness to compensate for the fact that he is not sufficiently strong in weapons, ammunition and equipment.

The career military officers and the government police have modern weapons and transport, and can go about anywhere freely, using the force of their own strength. The urban guerrilla does not have such resources at his disposal, and leads a clandestine existence. The guerrilla may be a convicted person or one who is out on parole, and must then use false documents.

Nevertheless, the urban guerrilla has an advantage over the conventional military or the police. It is that, while the military and the police act on behalf of the enemy, whom the people hate, the urban guerrilla defends a just cause, which is the people's cause.

The urban guerrilla's weapons are inferior to the enemy's, but from the moral point of view, the urban guerrilla has an undeniable superiority. This moral superiority is what sustains the urban guerrilla. Thanks to it, the urban guerrilla can accomplish his principle duty, which is to attack and survive.

The urban guerrilla has to capture or steal weapons from the enemy to be able to fight. Because his weapons are not uniform—since what he has are expropriated or have fallen into his hands in various ways—the urban guerrilla faces the problem of a variety of weapons and a shortage of ammunition. Moreover, he has no place in which to practice shooting and marksmanship. These difficulties have to be overcome, forcing the urban guerrillas to be imaginative and creative—qualities without which it would be impossible for him to carry out his role as a revolutionary.

The urban guerrilla must possess initiative, mobility and flexibility, as well as versatility and a command of any situation. Initiative especially is an indispensable quality. It is not always possible to foresee everything, and the urban guerrilla cannot let himself become confused, or wait for instructions. His duty is to act, to find adequate solutions for each problem he faces, and to retreat. It is better to err acting than to do nothing for fear of making a mistake. Without initiative, there is no urban guerrilla warfare.

Other important qualities in the urban guerrilla are the following: to be a good walker; to be able to stand up against fatigue, hunger, rain or heat. To know how to hide, and how to be vigilant. To conquer the art of dissembling. Never to fear danger. To behave the same by day as by night. Not to act impetuously. To have unlimited patience. To remain calm and cool in the worst of conditions and situations. Never to leave a track or trail. Not to get discouraged.

In the face of the almost insurmountable difficulties in urban guerrilla warfare, sometimes comrades weaken and give up the fight.

The urban guerrilla is not a businessman in an urban company, nor is he an actor in a play. Urban guerrilla warfare, like rural guerrilla warfare, is a pledge which the guerrilla makes to himself. When he can no longer face the difficulties, or if he knows that he lacks the patience to wait, then it is better for him to relinquish his role before he betrays his pledge, for he clearly lacks the basic qualities necessary to be a guerrilla.

3) HOW THE URBAN GUERRILLA LIVES

The urban guerrilla must know how to live among the people, and he must be careful not to appear strange and different from ordinary city life. He should not wear clothes that are different from those that other people wear. Elaborate and high-fashion clothing for men or women may often be a handicap if the urban guerrilla's mission takes him into working class neighborhoods, or sections where such dress is uncommon. The same care has to be taken if the urban guerrilla must move from the South of the country to the North, and vice versa.

The urban guerrilla must make his living through his job or his professional activity. If he is known and sought by the police, he must go underground, and sometimes must live hidden. Under such circumstances, the urban guerrilla cannot reveal his activity to anyone, since this information is always and only the responsibility of the revolutionary organization in which he is participating.

The urban guerrilla must have a great ability for observation. He must be well-informed about everything, particularly about the enemy's movements, and he must be very inquisitive and knowledgeable about the area in which he lives, operates, or travels through.

But the fundamental characteristic of the urban guerrilla is that he is a man who fights with weapons; given these circumstances, there is very little likelihood that he will be able to follow his normal profession for long without being identified by the police. The role of expropriation thus looms as clear as high noon. It is impossible for the urban guerrilla to exist and survive without fighting to expropriate.

Thus, the armed struggle of the urban guerrilla points towards two essential objectives:

- 1) the physical elimination of the leaders and assistants of the armed forces and of the police;
- 2) the expropriation of government resources and the wealth belonging to the rich businessmen, [Here we see already the absence of Sabbatean-Frankist Jewish humanity, no difference is made between the rich who were born poor and built their fortune and those who parasitically exploited the working class.] the large landowners and the imperialists, with small expropriations used for the sustenance of the individual guerrillas and large ones for the maintenance of the revolutionary organization itself.

It is clear that the armed struggle of the urban guerrilla also has other objectives. But here we are referring to the two basic objectives, above all expropriation. It is necessary for every urban guerrilla to always keep in mind that he can only maintain his existence if he is able to kill the police and those dedicated to repression, and if he is determined—truly determined—to expropriate the wealth of the rich businessmen, landowners and imperialists.

One of the fundamental characteristics of the Brazilian revolution is that, from the beginning, it developed around the expropriation of the wealth of the major business, imperialist and landowning interests, without excluding the largest and most powerful commercial elements engaged in the import-export business. And by expropriating the wealth of the principle enemies of the people, the Brazilian revolution was able to hit them at their vital center, with preferential and systematic attacks on the banking network—that is to say, the most telling blows were levelled at the businessman's nerve system.

The bank robberies carried out by the Brazilian urban guerrillas hurt big businesses and others, the foreign companies which insure and re-insure the banking capital, the imperialist companies, the federal and state governments—all of them are systematically expropriated as of now.

The fruit of these expropriations has been devoted to the tasks of learning and perfecting urban guerrilla techniques, the purchase, production and transportation of weapons and ammunition for the rural areas, the security precautions of the guerrillas, the daily maintenance of the fighters, those who have been liberated from prison by armed force, those who have been wounded, and those who are being persecuted by the police, and to any kind of problem concerning comrades liberated from jail or assassinated by the police and the military dictatorship.

The tremendous costs of the revolutionary war must fall upon the big businesses, on the imperialists, on the large landowners, and on the government too—both federal and state—since they are all exploiters and oppressors of the people. Men of the government, agents of the dictatorship and of foreign imperialism, especially, must pay with their lives for the crimes they have committed against the Brazilian people.

In Brazil, the number of violent actions carried out by urban guerrillas, including executions, explosions, seizures of weapons, ammunition and explosives, assaults on banks and prisons, etc., is significant enough to leave no room for doubt as to the actual aims of the revolutionaries; all are witnesses to the fact that we are in a full revolutionary war and that this war can be waged only by violent means.

This is the reason why the urban guerrilla uses armed struggle, and why he continues to concentrate his efforts on the physical extermination of the agents of repression, and to dedicate 24 hours a day to expropriations from the people's exploiters.

4) TECHNICAL PREPARATION OF THE URBAN GUERRILLA

No one can become an urban guerrilla without paying special attention to technical preparation.

The technical preparation of the urban guerrilla runs from a concern for his physical condition to a knowledge of and apprenticeship in professions and skills of all kinds, particularly manual skills.

The urban guerrilla can have a strong physical constitution only if he trains systematically. He cannot be a good fighter if he has not learned the art of fighting. For that reason, the urban guerrilla must learn and practice the various forms of unarmed fighting, of attack, and of personal defense. Other useful forms of physical preparation are hiking, camping, the practice of survival in the woods, mountain climbing, rowing, swimming, skin diving and training as a frogman, fishing, harpooning, and the hunting of birds and of small and big game.

It is very important to learn how to drive a car, pilot a plane, handle a motor boat and a sailboat, understand mechanics, radio, telephone, electricity and have some knowledge of electronics techniques. [Note here that the enemy rarely follows this advice, preferring to engage in carnal pleasures and merely learning a singular role to a good degree. The list of skills mentioned is recommended as you have the willpower and strength to better yourself as compared to their slovenliness. **That being said NEVER underestimate your enemy.**] It is also important to have a knowledge of topographical information, to be able to determine one's position by instruments or other available resources, to calculate distances, make maps and plans, draw to scale, make timings, and work with an angle protractor, a compass, etc. A knowledge of chemistry, of color combination and of stamp-making, the mastery of the skills of calligraphy and the copying of letters, and other techniques are part of the technical preparation of the urban guerrilla, who is obliged to falsify documents in order to live within a society that he seeks to destroy. In the area of "makeshift" medicine, the urban guerrilla has the special role of being a doctor or understanding medicine, nursing, pharmacology, drugs, basic surgery and emergency first aid.

The basic question in the technical preparation of the urban guerrilla is, nevertheless, to know how to handle weapons such as the submachine gun, revolver, automatic pistol, FAL, various types of shotguns, carbines, mortars, bazookas, etc.

A knowledge of various types of ammunition and explosives is another aspect to consider. Among the explosives, dynamite must be well understood. The use of incendiary bombs, smoke bombs, and other types is also indispensable prior training. To know how to improvise and repair weapons, prepare Molotov cocktails, grenades, mines, homemade destructive devices, how to blow up bridges, tear up and put out of service railroads and railroad cars, these are necessities in the technical preparation of the urban guerrilla that can never be considered unimportant.

The highest level of preparation for the urban guerrilla is the training camp for technical training. But only the guerrilla who has already passed a

preliminary examination can go to this school—that is to say, one who has passed the test of fire in revolutionary action, in actual combat against the enemy.

5) THE URBAN GUERRILLA'S WEAPONS

The urban guerrilla's weapons are light arms, easily obtained, usually captured from the enemy, purchased, or made on the spot. Light weapons have the advantage of fast handling and easy transport. In general, light weapons are characterized as being short-barrelled. This includes many automatic weapons. Automatic and semi-automatic weapons considerably increase the firepower of the urban guerrilla. The disadvantage of this type of weapon, for us, is the difficulty in controlling it, resulting in wasted rounds or a wasteful use of ammunition—corrected for only by a good aim and precision firing. Men who are poorly trained convert automatic weapons into an ammunition drain.

Experience has shown that the basic weapon of the urban guerrilla is the light submachine gun. This weapon, in addition to being efficient and easy to shoot in an urban area, has the advantage of being greatly respected by the enemy. The guerrilla must thoroughly know how to handle the submachine gun, now so popular and indispensable to the Brazilian urban guerrillas.

The ideal submachine gun for the urban guerrilla is the INA .45 caliber. Other types of submachine guns of different calibers can also be used—understanding of course, the problem of ammunition. Thus, it is preferable that the manufacturing capabilities of the urban guerrillas be used for the production of one type of submachine gun, so that the ammunition to be used can be standardized. Each firing group of urban guerrillas must have a submachine gun handled by a good marksman. The other members of the group must be armed with .38 revolvers, our standard weapon. The .32 is also useful for those who want to participate. But the .38 is preferable since its impact usually puts the enemy out of action.

Hand grenades and conventional smoke bombs can also be considered light weapons, with defensive power for cover and withdrawal.

Long-barrelled weapons are more difficult for the urban guerrilla to transport, and they attract much attention because of their size. Among the long-barrelled weapons are the FAL, the Mauser guns or rifles, hunting guns such as the Winchester, and others.

Shotguns can be useful if used at close range and point blank. They are useful even for a poor shot, especially at night when precision isn't much help. A pressure airgun can be useful for training in marksmanship. Bazookas and mortars can also be used in action, but the conditions for using them have to be prepared and the people who use them must be trained.

The urban guerrilla should not attempt to base his actions on the use of heavy weapons, which have major drawbacks in a type of fighting that demands lightweight weapons to insure mobility and speed.

Homemade weapons are often as efficient as the best weapons produced in conventional factories, and even a sawed-off shotgun is a good weapon for the urban guerrilla fighter.

i) Weapons

The urban guerrilla's role as a gunsmith has a basic importance. As a gunsmith, he takes care of the weapons, knows how to repair them, and in many cases can set up a small shop for improvising and producing effective small arms.

Experience in metallurgy and on the mechanical lathe are basic skills the urban guerrilla should incorporate into his manufacturing plans for the construction of homemade weapons. This production, and courses in explosives and sabotage, must be organized. The primary materials for practice in these courses must be obtained ahead of time, to prevent an incomplete apprenticeship—that is to say, so as to leave no room for experimentation.

Molotov cocktails, gasoline, homemade contrivances such as catapults and mortars for firing explosives, grenades made of pipes and cans, smoke bombs, mines, conventional explosives such as dynamite and potassium chlorate, plastic explosives, gelatine capsules, and ammunition of every kind are indispensable to the success of the urban guerrilla's mission.

The methods of obtaining the necessary materials and munitions will be to buy them or to take them by force in expropriation actions specially planned and carried out. The urban guerrillas will be careful not to keep explosives and other materials that can cause accidents around for very long, but will always try to use them immediately on their intended targets.

The urban guerrilla's weapons and his ability to maintain them constitute his firepower. By taking advantage of modern weapons and introducing innovations in his firepower and in the use of certain weapons, the urban guerrilla can improve many of the tactics of urban warfare. An example of this was the innovation made by the Brazilian urban guerrillas when they introduced the use of the submachine gun in their attacks on banks.

When the massive use of uniform submachine guns becomes possible, there will be new changes in urban guerrilla warfare tactics. The firing group that utilizes uniform weapons and corresponding ammunition, with reasonable care for their maintenance, will reach a considerable level of effectiveness. The urban guerrilla increases his effectiveness as he increases his firepower.

6) THE SHOT; THE URBAN GUERRILLA'S REASON FOR EXISTENCE

The urban guerrilla's reason for existence, the basic condition in which he acts and survives, is to shoot. The urban guerrilla must know how to shoot well, because it is required by this type of combat.

In conventional warfare, combat is generally at a distance with long-range weapons. In unconventional warfare, in which urban guerrilla warfare is included, combat is at short range and often very close. To prevent his own death, the urban guerrilla must shoot first, and he cannot err in his shot. He cannot waste his ammunition because he does not possess large amounts, and so he must conserve it. Nor can he replace his ammunition quickly, since he is a part of a small team in which each guerrilla has to be able to look after himself. The urban guerrilla can lose no time, and thus has to be able to shoot at once.

One basic fact, which we want to emphasize completely, and whose importance cannot be overestimated, is that the urban guerrilla must not fire continuously, using up his ammunition. It may be that the enemy is responding to this fire precisely because he is waiting until the guerrilla's ammunition is all used up. At such a moment, without having the opportunity to replace his ammunition, the guerrilla faces a rain of enemy fire, and can be taken prisoner or killed.

In spite of the value of the surprise factor, which many times makes it unnecessary for the urban guerrilla to use his weapons, he cannot be allowed the luxury of entering combat without knowing how to shoot. And when face-to-face with the enemy, he must always be moving from one position to another, since to stay in one place makes him a fixed target and, as such, very vulnerable.

The urban guerrilla's life depends on shooting, on his ability to handle his weapons well and to avoid being hit. When we speak of shooting, we speak of accuracy as well. Shooting must be practiced until it becomes a reflex action on the part of the urban guerrilla. To learn how to shoot and have good aim, the urban guerrilla must train himself systematically, utilizing every practice method shooting at targets, even in amusement parks and at home.

Shooting and marksmanship are the urban guerrilla's water and air. His perfection of the art of shooting may make him a special type of urban guerrilla—that is, a sniper, a category of solitary combatant indispensable in isolated actions. The sniper knows how to shoot at close range and at long range, and his weapons are appropriate for either type of shooting.

7) THE FIRING GROUP

In order to function, the urban guerrillas must be organized into small groups. A team of no more than four or five is called a firing group. A minimum of two firing groups, separated and insulated from other firing groups, directed and coordinated by one or two persons, this is what makes a firing team.

Within the firing group, there must be complete confidence among the members. The best shot, and the one who knows best how to handle the submachine gun, is the person in charge of operations.

The firing group plans and executes urban guerrilla actions, obtains and stores weapons, and studies and corrects its own tactics.

When there are tasks planned by the strategic command, these tasks take preference. But there is no such thing as a firing group without its own initiative. For this reason, it is essential to avoid any rigidity in the guerrilla organization, in order to permit the greatest possible initiative on the part of the firing group. The old-type hierarchy, the style of the traditional revolutionaries, doesn't exist in our organization. This means that, except for the priority of the objectives set by the strategic command, any firing group can decide to raid a bank, to kidnap or execute an agent of the dictatorship, a figure identified with the reaction, or a foreign spy, and can carry out any type of propaganda or war of nerves against the enemy, without the need to consult with the general command.

No firing group can remain inactive waiting for orders from above. Its obligation is to act. Any single urban guerrilla who wants to establish a firing group and begin action can do so, and thus becomes a part of the organization.

This method of action eliminates the need for knowing who is carrying out which actions, since there is free initiative and the only important point is to greatly increase the volume of urban guerrilla activity in order to wear out the government and force it onto the defensive.

The firing group is the instrument of organized action. Within it, guerrilla operations and tactics are planned, launched and carried through to success. The general command counts on the firing groups to carry out objectives of a strategic nature, and to do so in any part of the country. For its part, the general command helps the firing groups with their difficulties and with carrying out objectives of a strategic nature, and to do so in any part of the country.

The organization is an indestructable network of firing groups, and of coordinations among them, that functions simply and practically within a general command that also participates in attacks—an organization that exists for no other purpose than that of pure and simple revolutionary action.

8) THE LOGISTICS OF THE URBAN GUERRILLA

Conventional logistics can be expressed with the **formula FFEA**:

F—food

F—fuel

E—equipment

A—ammunition

Conventional logistics refer to the maintenance problems for an army or a regular armed force, transported in vehicles, with fixed bases and supply lines. Urban guerrillas, on the contrary, are not an army but small armed groups, intentionally fragmented. They have neither vehicles nor rear areas. Their supply lines are precarious and insufficient, and they have no fixed bases except in the rudimentary sense of a weapons factory within a house. While the goal of conventional logistics is to supply the war needs of the "gorillas" who are used to repress rural and urban rebellion, urban guerrilla logistics aim at sustaining operations and tactics which have nothing in common with conventional warfare and are directed against the government and foreign domination of the country. For the urban guerrilla, who starts from nothing and who has no support at the beginning, logistics are expressed by the **formula MMWAE**, which is:

M—mechanization

M—money

W—weapons

A—ammunition

E—explosives

Revolutionary logistics takes mechanization as one of its bases. Nevertheless, mechanization is inseparable from the driver. The urban guerrilla driver is as important as the urban guerrilla machine gunner. Without either, the machines do not work, and the automobile, as well as the submachine gun becomes a dead

thing. An experienced driver is not made in one day, and apprenticeship must begin early. Every good urban guerrilla must be a driver. As to the vehicles, the urban guerrilla must expropriate what he needs. When he already has resources, the urban guerrilla can combine the expropriation of vehicles with his other methods of acquisition.

Money, weapons, ammunition and explosives, and automobiles as well, must be expropriated. The urban guerrilla must rob banks and armories, and seize explosives and ammunition wherever he finds them.

None of these operations is carried out for just one purpose. Even when the raid is to obtain money, the weapons that the guards carry must be taken as well.

Expropriation is the first step in organizing our logistics, which itself assumes an armed and permanently mobile character.

The second step is to reinforce and expand logistics, resorting to ambushes and traps in which the enemy is surprised and his weapons, ammunition, vehicles and other resources are captured.

Once he has weapons, ammunition and explosives, one of the most serious logistics problems facing the urban guerrilla is a hiding place in which to leave the material, and appropriate means of transporting it and assembling it where it is needed. This has to be accomplished even when the enemy is alerted and has the roads blocked.

The knowledge that the urban guerrilla possesses of the terrain, and the devices he uses or is capable of using, such as scouts specially prepared and recruited for this mission, are the basic elements in solving the eternal logistics problems faced by the guerrillas.

9) CHARACTERISTICS OF THE URBAN GUERRILLA'S TACTICS

The tactics of the urban guerrilla have the following characteristics:

1) It is an aggressive tactic, or, in other words, it has an offensive character. As is well known, defensive action means death for us. Since we are inferior to the enemy in firepower, and have neither his resources nor his power base, we cannot defend ourselves against an offensive or a concentrated attack by the "gorillas". That is the reason why our urban technique can never be permanent, can never defend a fixed base nor remain in any one spot waiting to repel the circle of repression.

2) It is a tactic of attack and rapid withdrawal, by which we preserve our forces.

3) It is a tactic that aims at the development of urban guerrilla warfare, whose function will be to wear out, demoralize and distract the enemy forces, permitting the emergence and survival of rural guerrilla warfare, which is destined to play the decisive role in the revolutionary war.

10) THE INITIAL ADVANTAGES OF THE URBAN GUERRILLA

The dynamics of urban guerrilla warfare lie in the guerrilla's violent clash with the military and police forces of the dictatorship. In this conflict, the police have superiority. The urban guerrilla has inferior forces. The paradox is that the urban guerrilla is nevertheless the attacker.

The military and police forces, for their part, respond to the conflict by mobilizing and concentrating greatly superior forces in the pursuit and destruction of the urban guerrilla. The guerrilla can only avoid defeat if he depends on the initial advantages he has and knows how to exploit them to the end, to compensate for his weakness and lack of material.

The initial advantages are:

- 1) He must take the enemy by surprise.
- 2) He must know the terrain of the encounter.
- 3) He must have greater mobility and speed than the police and other repressive forces.
- 4) His information service must be better than the enemy's.
- 5) He must be in command of the situation, and demonstrate a decisiveness so great that everyone on our side is inspired and never thinks of hesitating, while on the other side the enemy is stunned and incapable of acting.

11) SURPRISE

To compensate for his general weakness and shortage of weapons compared to the enemy, the urban guerrilla uses surprise. The enemy has no way to combat surprise and becomes confused and is destroyed.

When urban guerrilla warfare broke out in Brazil, experience proved that surprise was essential to the success of any guerrilla operation.

The technique of surprise is based upon four essential requirements:

- 1) We know the situation of the enemy we are going to attack, usually by means of precise information and meticulous observation, while the enemy does not know he is going to be attacked and knows nothing about the attackers.
- 2) We know the strength of the enemy we are going to attack, and the enemy knows nothing about our strength.
- 3) Attacking by surprise, we save and conserve our forces, while the enemy is unable to do the same, and is left at the mercy of events.
- 4) We determine the time and place of the attack, fix its duration and establish its objectives. The enemy remains ignorant of all of this information.

12) KNOWLEDGE OF THE TERRAIN

The urban guerrilla's best ally is the terrain, and because this is so he must know it like the palm of his hand. To have the terrain as an ally means to know how to use with intelligence its unevenness, its high and low points, its turns, its irregularities, its fixed and secret passages, its abandoned areas, its thickets, etc., taking maximum advantage of all of this for the success of armed actions, escapes, retreats, covers, and hiding places. Impasses and narrow spots, gorges, streets under repair, police checkpoints, military zones and closed-off streets, the

entrances and exits to tunnels and those that the enemy can close off, corners controlled or watched by the police, traffic lights and signals; all this must be thoroughly known and studied in order to avoid fatal errors.

Our problem is to get through and to know where and how to hide, leaving the enemy bewildered in areas he doesn't know. Being familiar with the avenues, streets, alleys, ins and outs, the corners of the urban centers, its paths and shortcuts, its empty lots, its underground passages, its pipes and sewer systems, the urban guerrilla safely crosses through the irregular and difficult terrain unfamiliar to the police, where the police can be surprised in a fatal ambush or trap at any moment.

Because he knows the terrain, the urban guerrilla can pass through it on foot, on bicycle, in a car, jeep or small truck, and never be trapped. Acting in small groups with only a few people, the guerrillas can rendezvous at a time and place determined beforehand, following up the initial attack with new guerrilla operations, or evading the police cordon and disorienting the enemy with their unexpected audacity.

It is an impossible problem for the police, in the labyrinthian terrain of the urban guerrilla, to catch someone they cannot see, to repress someone they cannot catch, and to close in on someone they cannot find.

Our experience is that the ideal guerrilla is one who operates in his own city and thoroughly knows its streets, its neighborhoods, its transit problems, and its other peculiarities. The guerrilla outsider, who comes to a city whose streets are unfamiliar to him, is a weak spot, and if he is assigned certain operations, he can endanger them. To avoid grave mistakes, it is necessary for him to get to know the layout of the streets.

13) MOBILITY AND SPEED

To insure a mobility and speed that the police cannot match, the urban guerrilla needs the following:

- 1) Mechanization
- 2) Knowledge of the terrain
- 3) A disruption or suspension of enemy transport and communications
- 4) Light weapons

By carefully carrying out operations that last only a few moments, and leaving the site in mechanized vehicles, the urban guerrilla beats a rapid retreat, escaping capture.

The urban guerrilla must know the way in detail, and, in this manner, must go through the schedule ahead of time as a training, to avoid entering alleyways that have no exit, or running into traffic jams, or being stopped by the Transit Department's traffic signals.

The police pursue the urban guerrilla blindly, without knowing which road he is using for his escape. While the urban guerrilla escapes quickly because he knows the terrain, the police lose the trail and give up the chase.

The urban guerrilla must launch his operations far from the logistical centers of the police. A primary advantage of this method of operation is that it

places us at a reasonable distance from the possibility of capture, which facilitates our evasion.

In addition to this necessary precaution, the urban guerrilla must be concerned with the enemy's communication system. The telephone is the primary target in preventing the enemy from access to information, by knocking out his communications systems.

Even if he knows about the guerrilla operation, the enemy depends on modern transportation for his logistics support, and his vehicles necessarily lose time carrying him through the heavy traffic of the large cities. It is clear that the tangled and treacherous traffic is a disadvantage for the enemy, as it would be for us if we were not ahead of him.

If we want to have a safe margin of security and be certain to leave no tracks for the future, we can adopt the following methods:

1) Deliberately intercept the police with other vehicles, or by seemingly casual inconveniences and accidents; but in this case the vehicles in question should neither be legal nor have real license numbers

2) Obstruct the roads with fallen trees, rocks, ditches, false traffic signs, dead ends or detours, or other clever methods

3) Place homemade mines in the way of the police; use gasoline or throw Molotov cocktails to set their vehicles on fire

4) Set off a burst of submachine gun fire or weapons such as the FAL aimed at the motor and tires of the cars engaged in the pursuit

With the arrogance typical of the police and the military authorities, the enemy will come to fight us equipped with heavy guns and equipment, and with elaborate maneuvers by men armed to the teeth. The urban guerrilla must respond to this with light weapons that can be easily transported, so he can always escape with maximum speed without ever accepting open fighting. The urban guerrilla has no mission other than to attack and quickly withdraw. We would leave ourselves open to the most crushing defeats if we burdened ourselves with heavy weapons and with the tremendous weight of the ammunition necessary to use them, at the same time losing our precious gift of mobility.

When our enemy fights against us with the cavalry, we are at no disadvantage as long as we are mechanized. The automobile goes faster than the horse. From within the car, we also have the target of the mounted police, knocking him down with submachine gun and revolver fire or with Molotov cocktails and hand grenades.

On the other hand, it is not so difficult for an urban guerrilla on foot to make a target of a policeman on horseback. Moreover, ropes across the street, marbles, and cork stoppers are very efficient methods of making them both fall. The great disadvantage faced by the mounted policeman is that he presents the urban guerrilla with two excellent targets—the horse and its rider.

Apart from being faster than the horseman, the helicopter has no better chance in pursuit. If the horse is too slow compared to the urban guerrilla's automobile, the helicopter is too fast. Moving at 200 kilometers an hour, it will

never succeed in hitting from above a target that is lost among the crowds and street vehicles, nor can the helicopter land in public streets in order to capture someone. At the same time, whenever it flies too low, it will be excessively vulnerable to the fire of the urban guerrillas.

14) INFORMATION

The chances that the government has for discovering and destroying the urban guerrillas lessens as the power of the dictatorship's enemies becomes greater and more concentrated among the population.

This concentration of the opponents of the dictatorship plays a very important role in providing information about the actions of the police and government officials, as well as hiding the activities of the guerrillas. The enemy can also be thrown off with false information, which is worse for him because it is a tremendous waste.

By whatever means, the sources of information at the disposal of the urban guerrilla are potentially better than those of the police. The enemy is observed by the people, but he does not know who among the people transmits information to the urban guerrillas. The military and the police are hated by the people for the injustices and violence they have committed, and this facilitates obtaining information which is damaging to the activities of government agents. Information, which is only a small segment of popular support, represents an extraordinary potential in the hands of the urban guerrilla.

The creation of an intelligence service, with an organized structure, is a basic need for us. [This is to be exploited via infiltrations and counter-surveillance.] The urban guerrilla has to have vital information about the plans and movements of the enemy; where they are, how they move, the resources of their banking network, their means of communication, and the secret activities they carry out. The reliable information passed on to the guerrillas represents a well-aimed blow at the dictatorship. The dictatorship has no way to defend itself in the face of an important leak which facilitates our destructive attacks.

The enemy also wants to know what actions we are planning so he can destroy us or prevent us from acting. In this sense, the danger of betrayal is present, and the enemy encourages betrayal and infiltrates spies into the guerrilla organization. The urban guerrilla's technique against this enemy tactic is to denounce publicly the spies, traitors, informers and provocateurs. Since our struggle takes place among the people and depends on their sympathy—while the government has a bad reputation because of its brutality, corruption and incompetence—the informers, spies, traitors and the police come to be enemies of the people, without supporters, denounced to the urban guerrillas and, in many cases, properly punished.

For his part, the urban guerrilla must not evade the duty—once he knows who the spy or informer is—of physically wiping him out. This is the proper method, approved by the people, and it minimizes considerably the incidence of infiltration or enemy spying.

For complete success in the battle against spies and informers, it is essential to organize a counter-espionage or counter-intelligence service. Nevertheless, as far as information is concerned, it cannot all be reduced to a matter of knowing the enemy's moves and avoiding the infiltration of spies. Intelligence information must be broad—it must embrace everything, including the most insignificant material. There is a technique of obtaining information, and the urban guerrilla must master it. Following this technique, intelligence information is obtained naturally, as a part of the life of the people.

The urban guerrilla, living in the midst of the population and moving about among them, must be attentive to all types of conversations and human relations, learning how to disguise his interest with great skill and judgement. In places where people work, study, and live, it is easy to collect all kinds of information on payments, business, plans of all kinds, points of view, opinions, people's state of mind, trips, interior layout of buildings, offices and rooms, operations centers, etc.

Observation, investigation, reconnaissance, and exploration of the terrain are also excellent sources of information. The urban guerrilla never goes anywhere absentmindedly and without revolutionary precaution, always on the alert lest something occurs. Eyes and ears open, senses alert, his memory is engraved with everything necessary, now or in the future, to the continued activity of the guerrilla fighter.

Careful reading of the press with particular attention to the mass communication media, the research of accumulated data, the transmission of news and everything of note, a persistence in being informed and in informing others, all this makes up the intricate and immensely complicated question of information which gives the urban guerrilla a decisive advantage.

15) DECISIVENESS

It is not enough for the urban guerrilla to have in his favor surprise, speed, knowledge of the terrain, and information. He must also demonstrate his command of any situation and a capacity for decisiveness, without which all other advantages will prove to be useless.

It is impossible to carry out any action, however well-planned, if the urban guerrilla turns out to be indecisive, uncertain, irresolute. Even an action successfully begun can end in defeat if command of the situation and the capacity for decision falter in the middle of the execution of the plan. When this command of the situation and a capacity for decision are absent, the void is filled with hesitation and terror. The enemy takes advantage of this failure and is able to liquidate us.

The secret of the success of any operation, simple or complex, easy or difficult, is to rely on determined men. Strictly speaking, there are no simple operations: all must be carried out with the same care taken in the most difficult, beginning with the choice of the human elements—which means relying on leadership and the capacity for decision in every situation.

One can see ahead of time whether an action will be successful or not by the way its participants act during the preparatory period. Those who fall behind, who fail to make designated contacts, are easily confused, forget things, fail to complete the basic tasks of the work, possibly are indecisive men and can be a danger. It is better not to include them.

Decisiveness means to put into practice the plan that has been devised with determination, with audacity, and with an absolute firmness. It takes only one person who hesitates to lose all.

16) OBJECTIVES OF THE GUERRILLA'S ACTIONS

With his tactics developed and established, the urban guerrilla trains himself in methods of action leading to attack, and, in Brazil, has the following objectives:

1) To threaten the triangle within which the Brazilian state and North American domination are maintained, a triangle whose points are Rio, Sao Paulo and Belo Horizonte, and whose base is the axis Rio—San Paulo, where the giant industrial, financial, economic, political, cultural, military, and police complex that holds the decisive power of the country is located.

2) To weaken the local militia and the security systems of the dictatorship, given the fact that we are attacking and the "gorillas" defending, which means catching the government in a defensive position with its troops immobilized in the defense of the entire complex of national maintenance, with its ever-present fears of an attack on its strategic nerve centers, and without ever knowing where, how or when the attack will come.

3) To attack every area with many different armed groups, small in size, each self-contained and operating independently, to disperse the government forces in their pursuit of a thoroughly fragmented organization, instead of offering the dictatorship the opportunity to concentrate its forces in the destruction of one tightly organized system operating throughout the country.

4) To give proof of its combativeness, decision, firmness, determination, and persistence in the attack on the military dictatorship, in order to allow all rebels to follow in our example and to fight with urban guerrilla tactics.

Meanwhile, the government with all of its problems, incapable of halting guerrilla actions within the cities, will lose time and suffer endless attrition, and will finally be forced to pull back its repressive forces in order to mount guard over all the banks, industries, armories, military barracks, prisons, public offices, radio and television stations, North American firms, gas storage tanks, oil refineries, ships, airplanes, ports, airports, hospitals, health centers, blood banks, stores, garages, embassies, residences of high-ranking members of the regime such as ministers and generals, police stations, official organizations, etc.

5) To increase urban guerrilla actions gradually into an endless number of surprise raids, such that the government cannot leave the urban area to pursue guerrillas in the rural interior without running the risk of abandoning the cities and permitting rebellion to increase on the coast as well as the interior of the country.

6) To force the Army and the police, their commanders and their assistants, to give up the relative comfort and tranquility of their barracks and their usual rest, for a state of fear and growing tension in the expectation of attack, or in a search for trails which vanish without a trace.

7) To avoid open battle and decisive combat with the government, limiting the struggle to brief, rapid attacks with lightning results.

8) To insure for the urban guerrilla a maximum freedom of movement and of action, without ever relinquishing the use of armed action, remaining firmly oriented towards helping the formation of rural guerrilla warfare and supporting the construction of a revolutionary army for national liberation.

17) ON THE TYPES AND NATURE OF MISSIONS FOR THE URBAN GUERRILLA
In order to achieve the objectives previously listed, the urban guerrilla is obliged, in his tactics, to follow missions whose nature is as different or diversified as possible. The urban guerrilla does not arbitrarily choose this or that mission. Some actions are simple; others are complicated. The inexperienced guerrilla must be gradually introduced into actions and operations which run from the simple to the complex. He begins with small missions and tasks until he becomes completely experienced.

Before any action, the urban guerrilla must think of the methods and the personnel at his disposal to carry out the mission. Operations and actions that demand the urban guerrilla's technical preparation cannot be carried out by someone who lacks the technical skill.

With these precautions, the missions which the urban guerrilla can undertake are the following:

- 1) assaults
- 2) raids and penetrations
- 3) occupations
- 4) ambushes
- 5) street tactics
- 6) strikes and work stoppages
- 7) desertions, diversions, seizures,
- 8) expropriation of weapons,
- 9) ammunition and explosives
- 10) liberation of prisoners
- 11) executions
- 12) kidnappings
- 13) sabotage
- 14) terrorism
- 15) armed propaganda
- 16) war of nerves

18) ASSAULTS

Assaults are the armed attacks which we make to expropriate funds, liberate prisoners, capture explosives, submachine guns, and other types of weapons and ammunition. Assaults can take place in broad daylight or at night. Daytime assaults are made when the objective cannot be achieved at any other hour, such as the transport of money by banks, which is not done at night. Night assault is usually the most advantageous for the guerrilla. The ideal is for all assaults to take place at night, when conditions for a surprise attack are most favorable and the darkness facilitates escape and hides the identity of the participants. The urban guerrilla must prepare himself, nevertheless, to act under all conditions, daytime as well as night.

The most vulnerable targets for assaults are the following:

- 1) credit establishments
- 2) commercial and industrial enterprises, including plants for the manufacture of weapons and explosives
- 3) military establishments
- 4) commissaries and police stations
- 5) jails
- 6) government property
- 7) mass communications media
- 8) North American firms and properties
- 9) government vehicles, including military and police vehicles, trucks, armored vehicles, money carriers, trains, ships, and airplanes.

The assaults on businesses use the same tactics, because in every case the buildings represent a fixed target. Assaults on buildings are planned as guerrilla operations, varied according to whether they are against banks, a commercial enterprise, industries, military bases, commissaries, prisons, radio stations, warehouses for foreign firms, etc.

The assault on vehicles—money-carriers, armored vehicles, trains, ships, airplanes—are of another nature, since they are moving targets. The nature of the operation varies according to the situation and the circumstances—that is, whether the vehicle is stationary or moving. Armored cars, including military vehicles, are not immune to mines. Roadblocks, traps, ruses, interception by other vehicles, Molotov cocktails, shooting with heavy weapons, are efficient methods of assaulting vehicles. Heavy vehicles, grounded airplanes and anchored ships can be seized and their crews and guards overcome. Airplanes in flight can be hijacked by guerrilla action or by one person. Ships and trains in motion can be assaulted or captured by guerrilla operations in order to obtain weapons and ammunition or to prevent troop movements.

19) THE BANK ASSAULT AS POPULAR MISSION

The most popular mission is the bank assault. In Brazil, the urban guerrillas have begun a type of organized assault on the banks as a guerrilla operation. Today, this type of assault is widely used, and has served as a sort of preliminary test for the urban guerrilla in his training in the tactics of urban guerrilla warfare.

Important innovations in the tactics of assaulting banks have developed, guaranteeing escape, the withdrawal of money, and the anonymity of those involved. Among these innovations, we cite the shooting of tires of cars to prevent pursuit, locking people in the bank bathroom, making them sit on the floor, immobilizing the bank guards and taking their weapons, forcing someone to open the safe or the strong box, and using disguises.

Attempts to install bank alarms, to use guards or electronic detection devices prove fruitless when the assault is political and is carried out according to urban guerrilla warfare techniques. This guerrilla method uses new techniques to meet the enemy's tactical changes, has access to firepower that is growing every day, becomes increasingly more experienced and more confident, and uses a larger number of guerrillas every time; all to guarantee the success of operations planned down to the last detail.

The bank assault is a typical expropriation. But, as is true with any kind of armed expropriatory action, the guerrilla is handicapped by a two-fold competition:

- 1) competition from the outlaw

- 2) competition from the right-wing counter-revolutionary

This competition produces confusion, which is reflected in the people's uncertainty. It is up to the urban guerrilla to prevent this from happening, and to accomplish this he must use two methods:

- 1) He must avoid the outlaw's technique, which is one of unnecessary violence and the expropriation of goods and possessions belonging to the people

- 2) He must use the assault for propaganda purposes at the very moment it is taking place, and later distribute material, leaflets—every possible means of explaining the objectives and the principles of the urban guerrillas, as expropriator of the government and the ruling elite.

20) RAIDS AND PENETRATIONS

Raids and penetrations are rapid attacks on establishments located in neighborhoods, or even in the center of the city, such as small military units, commissaries, hospitals, to cause trouble, seize weapons, punish and terrorize the enemy, take reprisals, or to rescue wounded prisoners or those hospitalized under police guard. Raids and penetrations are also made on garages and depots to destroy vehicles and damage installations, especially if they are North American firms and property. When they take place on certain stretches of highway or in certain distant neighborhoods, these raids can serve to force the enemy to move great numbers of troops, a totally useless effort since when they get there they will find nobody to fight. When they are carried out on certain houses, offices, archives or public offices, their purpose is to capture or search for secret papers and documents with which to denounce deals, compromises and the corruption of men in government, their dirty deals and criminal transactions. Raids and penetrations are most effective if they are carried out at night.

21) OCCUPATIONS

Occupations are a type of attack carried out when the urban guerrilla stations himself in specific establishments and locations, for a temporary action against the enemy or for some propaganda purpose. The occupation of factories and schools during strikes, or at other times, is a method of protest or of distracting the enemy's attention. The occupation of radio stations is for propaganda purposes.

Occupation is a highly effective model for action but, in order to prevent losses and material damage to our forces, it is always a good idea to plan on the possibility of a forced withdrawal. It must always be meticulously planned, and carried out at the opportune moment. Occupations always have a time limit, and the swifter they are completed, the better.

22) AMBUSH

Ambushes are attacks, typified by surprise, when the enemy is trapped on the road or when he makes a police net surrounding a house or estate. A false alarm can bring the enemy to the spot, where he falls into a trap.

The principle object of the ambush is to capture enemy weapons and to punish him with death. Ambushes to halt passenger trains are for propaganda purposes, and, when they are troop trains, the object is to annihilate the enemy and seize his weapons. The urban guerrilla sniper is the kind of fighter specially suited for ambush, because he can hide easily in the irregularities of the terrain, on the roofs and the tops of buildings and apartments under construction. From windows and dark places, he can take careful aim at his chosen target.

Ambush has devastating effects on the enemy, leaving him unnerved, insecure and fearful.

23) STREET TACTICS

Street tactics are used to fight the enemy in the streets, utilizing the participation of the population against him.

In 1968, the Brazilian students used excellent street tactics against police troops, such as marching down streets against traffic and using slingshots and marbles against mounted police. Other street tactics consist of constructing barricades; pulling up paving blocks and hurling them at the police; throwing bottles, bricks, paperweights and other projectiles at the police from the top of office and apartment buildings; using buildings and other structures for escape, for hiding and for supporting surprise attacks. It is equally necessary to know how to respond to enemy tactics. When the police troops come wearing helmets to protect them against flying objects, we have to divide ourselves into two teams—one to attack the enemy from the front, the other to attack him in the rear—withdrawing one as the other goes into action to prevent the first from being struck by projectiles hurled by the second. By the same token, it is important to know how to respond to the police net. When the police designate certain of their men to go into the crowd and arrest a demonstrator, a larger group of urban guerrillas must surround the police group, disarming and beating them and at the same time allowing the prisoner to escape. This urban guerrilla operation is called "the net within a net".

When the police net is formed at a school building, a factory, a place where demonstrators gather, or some other point, the urban guerrilla must not give up or allow himself to be taken by surprise. To make his net effective, the enemy is obliged to transport his troops in vehicles and special cars to occupy strategic points in the streets, in order to invade the building or chosen locale. The urban guerrilla, for his part, must never clear a building or an area and meet in it without first knowing its exits, the way to break an encirclement, the strategic points that the police must occupy, and the roads that inevitably lead into the net, and he must hold other strategic points from which to strike at the enemy. The roads followed by police vehicles must be mined at key points along the way and at forced roadblocks. When the mines explode, the vehicles will be knocked into the air. The police will be caught in the trap and will suffer losses and be victims of an ambush. The net must be broken by escape routes which are unknown to the police. The rigorous planning of a withdrawal is the best way to frustrate any encircling effort on the part of the enemy. When there is no possibility of an escape plan, the urban guerrilla must not hold meetings, gatherings or do anything, since to do so will prevent him from breaking through the net which the enemy will surely try to throw around him.

Street tactics have revealed a new type of urban guerrilla who participates in mass protests. This is the type we designate as the "urban guerrilla demonstrator", who joins the crowds and participates in marches with specific and definite aims in mind. The urban guerrilla demonstrator must initiate the "net within the net", ransacking government vehicles, official cars and police vehicles before turning them over or setting fire to them, to see if any of them have money or weapons.

Snipers are very good for mass demonstrations, and along with the urban guerrilla demonstrator can play a valuable role. Hidden at strategic points, the snipers have complete success using shotguns or submachine guns, which can easily cause losses among the enemy.

24) STRIKES AND WORK INTERRUPTIONS

The strike is a model of action employed by the urban guerrilla in work centers and schools to damage the enemy by stopping work and study activities. Because it is one of the weapons most feared by the exploiters and oppressors, the enemy uses tremendous firepower and incredible violence against it. The strikers are taken to prison, suffer beatings, and many of them wind up killed.

The urban guerrilla must prepare the strike in such a way as to leave no track or clue that can identify the leaders of such an action. A strike is successful when it is organized by a small group, if it is carefully prepared in secret using the most clandestine methods. Weapons, ammunition, Molotov cocktails, homemade weapons of destruction and attack, all of these must be supplied beforehand in order to meet the enemy. So that the action can do the greatest possible amount of damage, it is a good idea to study and put into effect a sabotage plan. Strikes and study interruptions, although they are of brief duration, cause severe damage to the enemy. It is enough for them to crop up at different locations and in differing

sections of the same area, disrupting daily life, occurring endlessly, one after the other, in true guerrilla fashion.

In strikes or in simple work interruptions, the urban guerrilla has recourse to the occupation or penetration of the site, or he can simply make a raid. In that case, his objective is to take captives, to capture prisoners, or to capture enemy agents and propose an exchange for arrested strikers.

In certain cases, strikes and brief work interruptions can offer an excellent opportunity for preparing ambushes or traps, whose aim is the physical destruction of the police. The basic fact is that the enemy suffers losses as well as material and moral damage, and is weakened by the action.

25) DESERTIONS, DIVERSIONS, SEIZURES, EXPROPRIATION OF AMMUNITION AND EXPLOSIVES

Desertion and the diversion of weapons are actions carried out in military bases, ships, military hospitals, etc. The urban guerrilla soldier or officer must desert at the most opportune moment with modern weapons and ammunition, to hand them over to the guerrillas. One of the most opportune moments is when the urban guerrilla soldier is called upon to pursue his guerrilla comrades outside the military base. Instead of following the orders of the "gorillas", the military urban guerrilla must join the ranks of the revolutionaries by handing over the weapons and ammunition he carries, or the military vehicle he operates. The advantage of this method is that the rebels receive weapons and ammunition from the army, navy, air force, military police, civilian guard or the police without any great work, since it reaches their hands by government transportation.

Other opportunities may occur in the barracks, and the military urban guerrilla must always be alert to this. In case of carelessness on the part of commanders or in other favorable conditions—such as bureaucratic attitudes or the relaxation of discipline on the part of lieutenants or other internal personnel—the military urban guerrilla must no longer wait but must try to inform the guerrillas and desert with as large a supply of weapons as possible.

When there is no possibility of deserting with weapons and ammunition, the military urban guerrilla must engage in sabotage, starting fires and explosions in munitions dumps. This technique of deserting with weapons and of raiding and sabotaging the military centers is the best way of wearing out and demoralizing the enemy and leaving them confused. The urban guerrilla's purpose in disarming an individual enemy is to capture his weapons. These weapons are usually in the hands of sentinels or others whose task is guard duty. The capture of weapons may be accomplished by violent means or by cleverness and tricks or traps. When the enemy is disarmed, he must be searched for weapons other than those already taken from him. If we are careless, he can use the weapons that were not seized to shoot the urban guerrilla. The seizure of weapons is an efficient method of acquiring submachine guns, the urban guerrilla's most important weapon. When we carry out small operations or actions to seize weapons and ammunition, the materiel captured may be for personal use or for armaments and supplies for the firing teams.

The necessity to provide firepower for the urban guerrillas is so great that, in order to take off from the zero point, we often have to purchase one weapon, divert or capture a single gun. The basic point is to begin, and to begin with a spirit of decisiveness and boldness. The possession of a single submachine gun multiplies our forces. In a bank assault, we must be careful to seize the weapons of the bank guard. The rest of the weapons will be found with the treasurer, the bank tellers or the manager, and must also be seized. Quite often, we succeed in capturing weapons in police stations, as a result of raids. The capture of weapons, ammunition and explosives is the urban guerrilla's goal in assaulting commercial businesses, industries and quarries.

26) LIBERATION OF PRISONERS

The liberation of prisoners is an armed action designed to free jailed urban guerrillas. In daily struggle against the enemy, the urban guerrilla is subject to arrest, and can be sentenced to unlimited years in jail.

This does not mean that the battle ends here. For the guerrilla, his experience is deepened by prison, and struggle continues even in the dungeons where he is held. The imprisoned guerrilla views the prisons of the enemy as a terrain which he must dominate and understand in order to free himself by a guerrilla operation. There is no jail, either on an island, in a city penitentiary, or on a farm, that is impregnable to the slyness, cleverness and firepower of the rebels.

The urban guerrilla who is free views the jails of the enemy as the inevitable site of guerrilla actions designed to liberate his ideological comrades from prison. It is this combination of the urban guerrilla in freedom and the urban guerrilla in jail that results in the armed operations we refer to as "liberation of prisoners".

The guerrilla operations that can be used in liberating prisoners are the following;

- 1) riots in penal establishments, in correctional colonies or camps, or on transport or prison ships;
- 2) assaults on urban or rural prisons, detention centers, prison camps, or any other permanent or temporary place where prisoners are held;
- 3) assaults on prisoner transport trains or convoys;
- 4) raids and penetrations of prisons;
- 5) ambushing of guards who move prisoners.

27) EXECUTIONS

Execution is the killing of a foreign spy, of an agent of the dictatorship, of a police torturer, of a dictatorial personality in the government involved in crimes and persecutions against patriots, of a stool pigeon, informer, police agent or police provocateur. Those who go to the police of their own free will to make denunciations and accusations, who supply information and who finger people, must be executed when they are caught by the urban guerrillas.

Execution is a secret action, in which the least possible number of urban guerrillas are involved. In many cases, the execution can be carried out by a single sniper, patient, alone and unknown, and operating in absolute secrecy and in cold blood.

28) KIDNAPPING

Kidnapping is capturing and holding in a secret place a spy, political personality or a notorious and dangerous enemy of the revolutionary movement. Kidnapping is used to exchange or liberate imprisoned revolutionaries or to force the suspension of torture in jail by the military dictatorship.

The kidnapping of personalities who are well-known artists, sports figures or who are outstanding in some other field, but who have evidenced no political interest, can be a useful form of propaganda for the guerrillas, provided it occurs under special circumstances, and is handled so the public understands and sympathizes with it. The kidnappings of foreigners or visitors constitutes a form of protest against the penetration and domination of imperialism in our country.

29) SABOTAGE

Sabotage is a highly destructive type of attack using very few persons—and sometimes requiring only one—to accomplish the desired result. When the urban guerrilla uses sabotage, the first step is isolated sabotage. Then comes the step of dispersed and general sabotage, carried out by the population. Well-executed sabotage demands study, planning and careful action. A characteristic form of sabotage is explosion, using dynamite, fire or the placing of mines. A little sand, a trickle of any kind of combustible, a poor lubrication job, a screw removed, a short circuit, inserted pieces of wood or iron, can cause irreparable damage. The objective of sabotage is to hurt, to damage, to make useless and to destroy vital enemy points such as the following:

- 1) the economy of the country
- 2) agricultural or industrial production
- 3) transport and communication systems
- 4) military and police systems and their establishments and depots
- 5) the repressive military-police system
- 6) the firms and properties of exploiters in the country

The urban guerrilla should endanger the economy of the country, particularly its economic and financial aspects, such as its domestic and foreign banking network, its exchange and credit systems, its tax collection system, etc.

Public offices, centers of government and government depots are easy targets for sabotage. Nor will it be easy to prevent the sabotage of agricultural and industrial production [Do not emulate needless destruction of private property. A factory is just a building. A factory owner, however, is an individual, who may be held liable to any crimes which he has committed in service of the Zionist menace. Sabotage is only a valid tactic against factories of the enemy. Choose your targets wisely.] by the urban guerrilla, with his thorough knowledge of the local situation. Factory workers acting as urban guerrillas are excellent industrial saboteurs, since they, better than anyone, understand the industry, the factory, the machinery or the part most likely to destroy an entire operation, doing much more damage than a poorly-informed layman could do.

With respect to the enemy's transport and communications systems, beginning with railway traffic, it is necessary to attack them systematically with

sabotage. The only caution is against causing death and injury to passengers, especially regular commuters on suburban and long-distance trains. Attacks on freight trains, rolling or stationary stock, stoppage of military transports and communications systems, these are the major objectives in this area. Sleepers can be damaged and pulled up, as can rails. A tunnel blocked by a barrier of explosives, or an obstruction caused by a derailed car, causes enormous harm.

The derailment of a train carrying fuel is of major damage to the enemy. So is dynamiting a railroad bridge. In a system where the size and weight of the rolling equipment is enormous, it takes months for workers to repair or rebuild the destruction and damage. As for highways, they can be obstructed with trees, stationary vehicles, ditches, dislocation of barriers by dynamite, and bridges destroyed by explosions. Ships can be damaged at anchor in seaports or riverports, or in the shipyards. Aircraft can be destroyed or damaged on the ground. Telephone and telegraph lines can be systematically damaged, their towers blown up, and their lines made useless. Transport and communications must be sabotaged immediately because the revolutionary movement has already begun in Brazil, and it is essential to impede the enemy's movement of troops and munitions.

Oil lines, fuel plants, depots for bombs and ammunition arsenals, military camps and bases must become targets for sabotage operations, while vehicles, army trucks and other military or police vehicles must be destroyed wherever they are found. The military and police repression centers and their specialized organs must also claim the attention of the guerrilla saboteur. Foreign firms and properties in the country, for their part, must become such frequent targets of sabotage that the volume of actions directed against them surpasses the total of all other actions against enemy vital points.

30) TERRORISM

Terrorism is an action, usually involving the placement of an explosive or firebomb of great destructive power, which is capable of effecting irreparable loss against the enemy. Terrorism requires that the urban guerrilla should have adequate theoretical and practical knowledge of how to make explosives. The terrorist act, apart from the apparent ease with which it can be carried out, is no different from other guerrilla acts and actions whose success depends on planning and determination. It is an action which the urban guerrilla must execute with the greatest calmness and determination. Although terrorism generally involves an explosion, there are cases in which it may be carried out through executions or the systematic burning of installations, properties, plantations, etc. It is essential to point out the importance of fires and the construction of incendiary devices such as gasoline bombs in the technique of guerrilla terrorism. Another thing is the importance of the material the urban guerrilla can persuade the people to expropriate in the moments of hunger and scarcity brought about by the greed of the big commercial interests. [Who the National Socialist recognizes are controlled by the Council of 300 and the International Jew, among other helper golems. WE

SHALL SEVER THE HEAD OF THE SNAKE!] Terrorism is a weapon the revolutionary can never relinquish.

31) ARMED PROPAGANDA

The coordination of urban guerrilla activities, including each armed action, is the primary way of making armed propaganda. These actions, carried out with specific objectives and aims in mind, inevitably become propaganda material for the mass communication system. Bank robberies, ambushes, desertions and the diverting of weapons, the rescue of prisoners, executions, kidnappings, sabotage, terrorism and the war of nerves are all cases in point.

Airplanes diverted in flight by guerrilla action, ships and trains assaulted and seized by armed guerrillas, can also be carried out solely for propaganda effect. But the urban guerrilla must never fail to install a clandestine press, and must be able to turn out mimeographed copies using alcohol or electric plates and other duplicating apparatus, expropriating what he cannot buy in order to produce small clandestine newspapers, pamphlets, flyers and stamps for propaganda and agitation against the dictatorship.

The urban guerrilla engaged in clandestine printing facilitates enormously the incorporation of large numbers of people into the struggle, by opening a permanent work front for those willing to carry on propaganda, even when to do so means to act alone and risk their lives.

With the existence of clandestine propaganda and agitational material, the inventive spirit of the urban guerrilla expands and creates catapults, artifacts, mortars and other instruments with which to distribute the anti-government propaganda at a distance. Tape recordings, the occupation of radio stations, the use of loudspeakers, graffiti on walls and other inaccessible places are other forms of propaganda. A consistent propaganda by letters sent to specific addresses, explaining the meaning of the urban guerrilla's armed actions, produces considerable results and is one method of influencing certain segments of the population.

Even this influence—exercised in the heart of the people by every possible propaganda device, revolving around the activity of the urban guerrilla—does not indicate that our forces have everyone's support. It is enough to win the support of a portion of the population, and this can be done by popularizing the motto, "Let he who does not wish to do anything for the guerrillas do nothing against them."

32) THE WAR OF NERVES

The war of nerves or psychological warfare is an aggressive technique, based on the direct or indirect use of mass media and rumors in order to demoralize the government. In psychological warfare, the government is always at a disadvantage because it imposes censorship on the media and winds up in a defensive position by not allowing anything against it to filter through. At this point, it becomes desperate, is involved in greater contradictions and loss of prestige, and loses time and energy in an exhausting effort at control which is liable to be broken at any moment.

The objective of the war of nerves is to mislead, spreading lies among the authorities in which everyone can participate, thus creating an atmosphere of nervousness, discredit, insecurity, uncertainty and concern on the part of the government. [Note here again the indiscriminate terrorism of the evil lunatic jew-lover. All members of the government are condemned, even those who were deceived. The SS strives for justice and truth. Do NOT terrorize or attack without identifying the target!]

The best methods used by urban guerrillas in the war of nerves are the following:

1) Using the telephone and the mail to announce false clues to the police and government, including information on the planting of bombs and any other act of terrorism in public offices and other places—kidnapping and assassination plans. etc.—to force the authorities to wear themselves out by following up on the false information fed to them;

2) Letting false plans fall into the hands of the police to divert their attention;

3) Planting rumors to make the government uneasy;

4) Exploiting by every means possible the corruption, the mistakes and the failures of the government and its representatives, forcing them into demoralizing explanations and justifications in the very communication media they wish to maintain under censorship;

5) Presenting denunciations to foreign embassies, the United Nations, the papal nunciature, and the international commissions defending human rights or freedom of the press, exposing each concrete violation and each use of violence by the military dictatorship and making it known that the revolutionary war will continue with serious danger for the enemies of the population.

33) HOW TO CARRY OUT THE ACTION

The urban guerrilla who correctly carries through his apprenticeship and training must give the greatest possible importance to his method of carrying out actions, for in this he cannot commit the slightest error. Any carelessness in learning tactics and their use invites certain disaster, as experience teaches us every day. Common criminals commit errors frequently because of their tactics, and this is one of the reasons why the urban guerrillas must be so insistently preoccupied with following revolutionary tactics, and not the tactics of bandits. And not only for that reason. There is no urban guerrilla worthy of the name who ignores the revolutionary method of action and fails to practice it rigorously in the planning and execution of his activities.

"The giant is known by his toe." The same can be said of the urban guerrilla, who is known from afar by his correct tactics and his absolute fidelity to principle.

The revolutionary method of carrying out actions is strongly and forcefully based on the knowledge and use of the following elements;

1) investigation and intelligence gathering

2) observation and vigilance

- 3) reconnaissance, or exploration of the terrain
- 4) study and timing of routes
- 5) mapping
- 6) mechanization
- 7) careful selection of personnel
- 8) selection of firepower
- 9) study and practice in success
- 10) success
- 11) use of cover
- 12) retreat
- 13) dispersal
- 14) the liberation or transfer of prisoners
- 15) the elimination of evidence
- 16) the rescue of wounded

34) SOME OBSERVATIONS ON TACTICS

When there is no information, the point of departure for planning the action must be investigation, observation and vigilance. This method produces good results. In any event, even when there is information, it is essential to make observations to see that information is not at odds with observation or vice versa. Reconnaissance or exploration of the terrain and the study and timing of routes are so important that to omit them is to make a stab in the dark.

Mechanization, in general, is an underestimated factor in the tactics of conducting an action. Frequently, mechanization is left to the end, on the eve of the action, before anything is done about it. This is a mistake. Mechanization must be seriously considered. It must be undertaken with considerable foresight and with careful planning, based on careful and precise information. The care, conservation, maintenance and camouflaging of stolen vehicles are very important details of mechanization. When transportation fails, the primary action fails, with serious material and morale problems for the urban guerrillas. The selection of personnel requires great care in order to avoid the inclusion of indecisive or wavering persons who present the danger of contaminating others, a danger that must be avoided.

The withdrawal is equally or more important than the operation itself, to the point that it must be rigorously planned, including the possibility of defeat. One must avoid rescue or transfer of prisoners with children present, or anything to attract the attention of people passing through the area. The best thing is to make the rescue appear as natural as possible, winding through different routes or narrow streets that scarcely permit passage on foot, in order to avoid an encounter between two cars. The elimination of tracks is obligatory and demands the greatest caution—also in removing fingerprints and any other sign that could give the enemy information. Lack of care in the elimination of evidence is a factor that increases nervousness in our ranks, which the enemy often exploits.

35) RESCUE OF THE WOUNDED

The problem of the wounded in urban guerrilla warfare merits special attention. During guerrilla operations in the urban area, it may happen that some comrade is wounded by the police. When a guerrilla in the firing group has a knowledge of first aid, he can do something for the wounded comrade on the spot. Under no circumstances should the wounded guerrilla be abandoned at the site of the battle or left in the enemy's hands. One of the precautions we must take is to set up first-aid courses for men and women, courses in which guerrillas can learn the rudiments of emergency medicine. The urban guerrilla who is a doctor, nurse, medical student, pharmacist or who simply has had first aid training is a necessity in modern guerrilla struggle. A small manual of first aid for urban guerrillas, printed on mimeographed sheets, can also be produced by anyone who has enough knowledge.

In planning and carrying out an armed action, the urban guerrilla cannot forget the organization of medical support. This must be accomplished by means of a mobile or motorized clinic. You can also set up a mobile first aid station. Another solution is to utilize the skills of a medical comrade, who waits with his bag of equipment in a designated house to which the wounded are brought. The ideal would be to have our own well-equipped clinic, but this is very expensive unless we appropriate all of our materials.

When all else fails, it is often necessary to resort to legal clinics, using armed force if necessary to force a doctor to treat our wounded. In the eventuality that we fall back upon blood banks to purchase blood or plasma, we must not use legal addresses and certainly no addresses where the wounded can really be found, since they are under our care and protection. Nor should we supply the addresses of those involved in the guerrilla organization to the hospitals and health care clinics where we may take them. Such caution is indispensable to covering our tracks. The houses in which the wounded stay cannot be known to anyone but the small group of comrades responsible for their care and transport. Sheets, bloody clothing, medicine and any other indications of treatment of comrades wounded in combat must be completely eliminated from any place they visit to receive treatment.

36) GUERRILLA SECURITY

The urban guerrilla lives in constant danger of the possibility of being discovered or denounced. The primary security problem is to make certain that we are well-hidden and well-guarded, and that there are secure methods to keep the police from locating us. The worst enemy of the urban guerrilla, and the major danger that we run into, is infiltration into our organization by a spy or informer. The spy trapped within the organization will be punished with death. The same goes for those who desert and inform to the police. A well-laid security means there are no spies or agents infiltrated into our midst, and the enemy can receive no information about us even through indirect means. The fundamental way to insure this is to be strict and cautious in recruiting. Nor is it permissible for everyone to know everything and everyone. This rule is a fundamental ABC of urban guerrilla security. The enemy wants to annihilate us and fights relentlessly to find us and

destroy us, so our greatest weapon lies in hiding from him and attacking by surprise.

The danger to the urban guerrilla is that he may reveal himself through carelessness or allow himself to be discovered through a lack of vigilance. It is impermissible for the urban guerrilla to give out his own or any other clandestine address to the police, or to talk too much. Notations in the margins of newspapers, lost documents, calling cards, letters or notes, all these are evidence that the police never underestimate. Address and telephone books must be destroyed, and one must not write or hold any documents. It is necessary to avoid keeping archives of legal or illegal names, biographical information, maps or plans. Contact numbers should not be written down, but simply committed to memory. The urban guerrilla who violates these rules must be warned by the first one who notes this infraction and, if he repeats it, we must avoid working with him in the future. The urban guerrilla's need to move about constantly with the police nearby—given the fact that the police net surrounds the city—forces him to adopt various security precautions depending upon the enemy's movements. For this reason, it is necessary to maintain a daily information service about what the enemy appears to be doing, where the police net is operating and what points are being watched. The daily reading of the police news in the newspapers is a fountain of information in these cases. The most important lesson for guerrilla security is never, under any circumstances, to permit the slightest laxity in the maintenance of security measures and precautions within the organization.

Guerrilla security must also be maintained in the case of an arrest. The arrested guerrilla must reveal nothing to the police that will jeopardize the organization.

He must say nothing that will lead, as a consequence, to the arrest of other comrades, the discovery of addresses or hiding places, or the loss of weapons and ammunition.

37) THE SEVEN SINS OF THE URBAN GUERRILLA

Even when the urban guerrilla applies proper tactics and abides by its security rules, he can still be vulnerable to errors. There is no perfect urban guerrilla. The most he can do is make every effort to diminish the margin of error, since he cannot be perfect. One of the means we should use to diminish the possibility of error is to know thoroughly the seven deadly sins of the urban guerrilla and try to avoid them.

The first sin of the guerrilla is inexperience. The urban guerrilla, blinded by this sin, thinks the enemy is stupid, underestimates the enemy's intelligence, thinks everything is easy and, as a result, leaves evidence that can lead to disaster. Because of his inexperience, the urban guerrilla may also overestimate the forces of the enemy, believing them to be stronger than they really are. Allowing himself to be fooled by this presumption, the urban guerrilla becomes intimidated and remains insecure and indecisive, paralyzed and lacking in audacity.

The second sin of the urban guerrilla is to boast about the actions he has undertaken and to broadcast them to the four winds.

The third sin of the urban guerrilla is vanity. The guerrilla who suffers from this sin tries to solve the problems of the revolution by actions in the city, but without bothering about the beginnings and survival of other guerrillas in other areas. Blinded by success, he winds up organizing an action that he considers decisive and that puts into play the entire resources of the organization. Since we cannot afford to break the guerrilla struggle in the cities while rural guerrilla warfare has not yet erupted, we always run the risk of allowing the enemy to attack us with decisive blows.

The fourth sin of the urban guerrilla is to exaggerate his strength and to undertake actions for which he, as yet, lacks sufficient forces and the required infrastructure.

The fifth sin of the urban guerrilla is rash action. The guerrilla who commits this sin loses patience, suffers an attack of nerves, does not wait for anything, and impetuously throws himself into action, suffering untold defeats.

The sixth sin of the urban guerrilla is to attack the enemy when they are most angry.

The seventh sin of the urban guerrilla is to fail to plan things, and to act spontaneously.

38) POPULAR SUPPORT

One of the permanent concerns of the urban guerrilla is his identification with popular causes to win public support. Where government actions become inept and corrupt, the urban guerrilla should not hesitate to step in and show that he opposes the government, and thus gain popular sympathy. The present government, for example, imposes heavy financial burdens and excessively high taxes on the people. It is up to the urban guerrilla to attack the dictatorship's tax collection system and to obstruct its financial activities, throwing all the weight of armed action against it.

The urban guerrilla fights not only to upset the tax collection system—the weapon of armed action must also be directed against those government agencies that raise prices and those who direct them as well as against the wealthiest of the national and foreign profiteers and the important property owners. In short, against all those who accumulate huge fortunes out of the high cost of living, the wages of hunger, excessive prices and high rents. Foreign industries, such as refrigeration and other North American plants that monopolize the market and the manufacture of general food supplies, must be systematically attacked by the urban guerrillas. The rebellion of the urban guerrilla and his persistence in intervening in political questions is the best way of insuring popular support for the cause which we defend. We repeat and insist on repeating—it is the way of insuring popular support. As soon as a reasonable portion of the population begins to take seriously the actions of the urban guerrilla, his success is guaranteed.

The government has no alternative except to intensify its repression. The police networks, house searches, the arrest of suspects and innocent persons, and the closing off of streets make life in the city unbearable. The military dictatorship embarks on massive political persecution. Political assassinations and police

terror become routine. In spite of all this, the police systematically fail. The armed forces, the navy and the air force are mobilized to undertake routine police functions, but even so they can find no way to halt guerrilla operations or to wipe out the revolutionary organization, with its fragmented groups that move around and operate throughout the country. The people refuse to collaborate with the government, and the general sentiment is that this government is unjust, incapable of solving problems, and that it resorts simply to the physical liquidation of its opponents. [Note here the delusional assumption of popular support. The leftist worm crawls forth under the jewish paradigm never pausing to let righteous actions drum up support. The main goal of the SS should be to seek virtue and learning.] The political situation in the country is transformed into a military situation in which the "gorillas" appear more and more to be the ones responsible for violence, while the lives of the people grow worse.

When they see the military and the dictatorship on the brink of the abyss, and fearing the consequences of a civil war which is already well underway, the pacifiers (always to be found within the ruling elite) and the opportunists (partisans of nonviolent struggle) join hands and circulate rumors behind the scenes begging the hangmen for elections, "re-democratization", constitutional reforms, and other tripe designed to fool the people and make them stop the rebellion.

But, watching the guerrillas, the people now understand that it is a farce to vote in any elections which have as their sole objective guaranteeing the survival of the dictatorship and covering up its crimes. Attacking wholeheartedly this election farce and the so-called "political solution", which is so appealing to the opportunists, the urban guerrillas must become even more aggressive and active, resorting without pause to sabotage, terrorism, expropriations, assaults, kidnappings, executions, etc. This action answers any attempt to fool the people with the opening of Congress and the reorganization of political parties—parties of the government and of the positions which the government allows—when all the time parliament and the so-called "parties" only function thanks to the permission of the military dictatorship, in a true spectacle of puppets or dogs on a leash.

The role of the urban guerrilla, in order to win the support of the population, is to continue fighting, keeping in mind the interests of the people and heightening the disastrous situation within which the government must act. These are the conditions, harmful to the dictatorship, which permit the guerrillas to open rural warfare in the middle of an uncontrollable urban rebellion.

The urban guerrilla is engaged in revolutionary action for the people, and with them seeks the participation of the people in the struggle against the dictatorship and the liberation of the country. Beginning with the city and the support of the people, the rural guerrilla war develops rapidly, establishing its infrastructure carefully while the urban area continues the rebellion.

2. Jihadist Training Manual

The following are relevant (non-Koran based) excerpts from a training manual from the Islamic Jihadist Group Al Qaeda, special care should be taken to avoid replication of the tactics involving religious zealotry and suicide bombing. These tactics are rarely effective and lead to a clouded mind which will result in poor battle decisions. The leadership is advised to only use religion to maintain order in the most dire of circumstances, where perhaps men, on the brink of death, might reconnect with their religiosity regardless. Additionally, **it should be taken into account that Muslims are our natural allies against the jewish threat**, care should be taken not to conform to alien ideologies, however cooperation and diplomacy is proven to be more effective than fighting private religious wars on the battlefield. The National Socialist is committed not to factionism but to the right for all peoples to have security for their nation and race, even if the recent islamic invasion of Europe may result to mixed alliances and perspectives among the men. All Muslims who agree to join the war effort and fight for their own freedom against the international jew and his terrorist allies should be treated as allies. Any Muslims claiming to have a birthright to European soil are traitors to their Volk and Nations, and must be immediately expelled from any National Socialist military formation. Care should be taken to identify the use of Taqiyyah – religiously condoned lying, comparable to jew pilpul – and alliances and communications clearly monitored if said member is a new recruit or has not yet been proven in battle with his allies (or blood brothers, in the case of Islamic National Socialist formations).

As is the case with the prior manual, many of these tactics are outdated and should serve only as a reference point.

Sanitized excerpts from the AQ Manual

I) Principles of Military Organization

Military Organization has three main principles without which it cannot be established.

- 1) Military Organization commander and advisory council
- 2) The soldiers (individual members)
- 3) A clearly defined strategy

Military Organization Requirements:

The Military Organization dictates a number of requirements to assist it in confrontation and endurance. These are:

- 1) Forged documents and counterfeit currency
- 2) Apartments and hiding places
- 3) Communication means
- 4) Transportation means
- 5) Information
- 6) Arms and ammunition
- 7) Transport

Missions Required of the Military Organization:

The main mission for which the Military Organization is responsible is: The overthrow of the godless regimes and their replacement with an Islamic regime. Other missions consist of the following:

- 1) Gathering information about the enemy, the land, the installations, and the neighbors.
- 2) Kidnapping enemy personnel, documents, secrets, and arms.
- 3) Assassinating enemy personnel as well as foreign tourists.
- 4) Freeing the brothers who are captured by the enemy.
- 5) Spreading rumors and writing statements that instigate people against the enemy.
- 6) Blasting and destroying the places of amusement, immorality, and sin; not a vital target.
- 7) Blasting and destroying the embassies and attacking vital economic centers.
- 8) Blasting and destroying bridges leading into and out of the cities.

Importance of the Military Organization:

- 1) Removal of those personalities that block the call's path. [A different handwriting:] All types of military and civilian intellectuals and thinkers for the state.
- 2) Proper utilization of the individuals' unused capabilities.
- 3) Precision in performing tasks, and using collective views on completing a job from all aspects, not just one.
- 4) Controlling the work and not fragmenting it or deviating from it.

- 5) Achieving long-term goals such as the establishment of an Islamic state and short-term goals such as operations against enemy individuals and sectors.
- 6) Establishing the conditions for possible confrontation with the regressive regimes and their persistence.
- 7) Achieving discipline in secrecy and through tasks.

Financial Security Precautions:

- 1) Dividing operational funds into two parts: One part is to be invested in projects that offer financial return, and the other is to be saved and not spent except during operations.
- 2) Not placing operational funds [all] in one place.
- 3) Not telling the Organization members about the location of the funds.
- 4) Having proper protection while carrying large amounts of money.
- 5) Leaving the money with non-members and spending it as needed.

2) Forged Documents (IdentityCards, Records Books, Passports)

The following security precautions should be taken:

- 1) Keeping the passport in a safe place so it would not be seized by the security apparatus, and the brother it belongs to would have to negotiate its return (I'll give you your passport if you give me information)
- 2) All documents of the undercover brother, such as identity cards and passport, should be falsified.
- 3) When the undercover brother is traveling with a certain identity card or passport, he should know all pertinent [information] such as the name, profession, and place of residence.
- 4) The brother who has special work status (commander, communication link,...) should have more than one identity card and passport. He should learn the contents of each, the nature of the [indicated] profession, and the dialect of the residence area listed in the document.
- 5) The photograph of the brother in these documents should be without a beard. It is preferable that the brother's public photograph [on these documents] be also without a beard. If he already has one [document] showing a photograph with a beard, he should replace it.
- 6) When using an identity document in different names, no more than one such document should be carried at one time.
- 7) The validity of the falsified travel documents should always be confirmed.
- 8) All falsification matters should be carried out through the command and not haphazardly (procedure control)
- 9) Married brothers should not add their wives to their passports.
- 10) When a brother is carrying the forged passport of a certain country, he should not travel to that country. It is easy to detect forgery at the airport, and the dialect of the brother is different from that of the people from that country.

Security Precautions Related to the Organizations' Given Names:

- 1) The name given by the Organization [to the brother] should not be odd in comparison with other names used around him.
- 2) A brother should not have more than one name in the area where he lives {the undercover work place}

3) FOURTH LESSON - Organization MILITARY BASES "APARTMENTS PLACES" - HIDING

Definition of Bases:

These are apartments, hiding places, command centers, etc. in which secret operations are executed against the enemy. These bases may be in cities, and are [then] called homes or apartments. They may be in mountainous, harsh terrain far from the enemy, and are [then] called hiding places or bases.

During the initial stages, the Military Organization usually uses apartments in cities as places for launching assigned missions, such as collecting information, observing members of the ruling regime, etc.

Hiding places and bases in mountains and harsh terrain are used at later stages, from which Jihad [holy war] groups are dispatched to execute assassination operations of enemy individuals, bomb their centers, and capture their weapons. In some Arab countries such as Egypt, where there are no mountains or harsh terrain, all stages of Jihad work would take place in cities. The opposite was true in Afghanistan, where initially Jihad work was in the cities, then the warriors shifted to mountains and harsh terrain. There, they started battling the Communists.

Security Precautions Related to Apartments:

- 1) Choosing the apartment carefully as far as the location, the size for the work necessary (meetings, storage, arms, fugitives, work preparation).
- 2) It is preferable to rent apartments on the ground floor to facilitate escape and digging of trenches.
- 3) Preparing secret locations in the apartment for securing documents, records, arms, and other important items.
- 4) Preparing ways of vacating the apartment in case of a surprise attack (stands, wooden ladders).
- 5) Under no circumstances should any one know about the apartment except those who use it.
- 6) Providing the necessary cover for the people who frequent the apartment (students, workers, employees, etc.)
- 7) Avoiding seclusion and isolation from the population and refraining from going to the apartment at suspicious times.
- 8) It is preferable to rent these apartments using false names, appropriate cover, and non-Moslem appearance.
- 9) A single brother should not rent more than one apartment in the same area, from the same agent, or using the same rental office.
- 10) Care should be exercised not to rent apartments that are known to the security apparatus [such as] those used for immoral or prior Jihad activities.

11) Avoiding police stations and government buildings. Apartments should not be rented near those places.

12) When renting these apartments, one should avoid isolated or deserted locations so the enemy would not be able to catch those living there easily.

13) It is preferable to rent apartments in newly developed areas where people do not know one another. Usually, in older quarters people know one another and strangers are easily identified, especially since these quarters have many informers.

14) Ensuring that there has been no surveillance prior to the members entering the apartment.

15) Agreement among those living in the apartment on special ways of knocking on the door and special signs prior to entry into the building's main gate to indicate to those who wish to enter that the place is safe and not being monitored. Such signs include hanging out a towel, opening a curtain, placing a cushion in a special way, etc.

16) If there is a telephone in the apartment, calls should be answered in an agreed-upon manner among those who use the apartment. That would prevent mistakes that would, otherwise, lead to revealing the names and nature of the occupants.

17) For apartments, replacing the locks and keys with new ones. As for the other entities (camps, shops, mosques), appropriate security precautions should be taken depending on the entity's importance and role in the work.

18) Apartments used for undercover work should not be visible from higher apartments in order not to expose the nature of the work.

19) In a newer apartment, avoid talking loud because prefabricated ceilings and walls [used in the apartments] do not have the same thickness as those in old ones.

20) It is necessary to have at hand documents supporting the undercover [member]. In the case of a physician, there should be an actual medical diploma, membership in the [medical] union, the government permit, and the rest of the routine procedures known in that country.

21) The cover should blend well [with the environment]. For example, selecting a doctor's clinic in an area where there are clinics, or in a location suitable for it.

22) The cover of those who frequent the location should match the cover of that location. For example, a common laborer should not enter a fancy hotel because that would be suspicious and draw attention.

4) FIFTH LESSON - MEANS OF COMMUNICATION AND TRANSPORTATION

In the name of Allah, the merciful and compassionate

Means of Transportation

Introduction:

It is well known that in undercover operations, communication is the mainstay of the movement for rapid accomplishment. However, it is a double-edged sword: It can be to our advantage if we use it well and it can be a knife dug into our back if we do not consider and take the necessary security measures.

Communication Means:

The Military Organization in any Islamic group can, with its modest capabilities, use the following means:

- 1) The telephone,
- 2) Meeting in-person,
- 3) Messenger,
- 4) Letters,
- 5) Some modern devices, such as the facsimile and wireless [communication].

Communication may be within the county, state, or even the country, in which case it is called local communication. When it extends expanded between countries, it is then called international communication.

Secret Communication is Limited to the Following Types:

Common, standby, alarm

1) **Common** Communication: It is a communication between two members of the Organization without being monitored by the security apparatus opposing the Organization. The common communication should be done under a certain cover and after inspecting the surveillance situation [by the enemy].

2) **Standby** Communication: This replaces common communication when one of the two parties is unable to communicate with the other for some reason.

3) **Alarm** Communication: This is used when the opposing security apparatus discovers an undercover activity or some undercover members. Based on this communication, the activity is stopped 'for a while, all matters related to the activity are abandoned, and the Organization's members are hidden from the security personnel.

Method of Communication Among Members of the Organization:

1) Communication about undercover activity should be done using a good cover; it should also be quick, explicit, and pertinent. That is, just for talking only.

2) Prior to contacting his members, the commander of the cell[2] should agree with each of them separately (the cell members should never meet all in one place and should not know one another) on a manner and means of communication with each other. Likewise, the chief of the Organization should [use a similar technique] with the branch commanders.

3) A higher-ranking commander determines the type and method of communication with lower-ranking leaders.

First Means: The Telephone:

Because of significant technological advances, security measures for monitoring the telephone and broadcasting equipment have increased. Monitoring may be done by installing a secondary line or wireless broadcasting device on a telephone that relays the calls to a remote location...That is why the Organization takes security measures among its members who use this means of communication (the telephone).

1) Communication should be carried out from public places. One should select telephones that are less suspicious to the security apparatus and are more difficult to monitor. It is preferable to use telephones in booths and on main streets.

[2]) Cell or cluster methods should be adopted by the Organization. It should be composed of many cells whose members do not know one another, so that if a cell member is caught the other cells would not be affected, and work would proceed normally.

2) Conversation should be coded or in general terms so as not to alert the person monitoring [the telephone].

3) Periodically examining the telephone wire and the receiver.

4) Telephone numbers should be memorized and not recorded. If the brother has to write them, he should do so using a code so they do not appear as telephone numbers (figures from a shopping list, etc.)

5) The telephone caller and person called should mention some words or sentences prior to bringing up the intended subject. The brother who is calling may misdial one of the digits and actually call someone else. The person 'called' may claim that the call is for him, and the calling brother may start telling him work-related issues and reveal many things because of a minor error.

6) In telephone conversations about undercover work, the voice should be changed and distorted.

7) When feasible, it is preferable to change telephone lines to allow direct access to local and international calls. That and proper cover facilitate communications and provide security protection not available when the central telephone station in the presence of many employees is used.

8) When a telephone [line] is identified [by the security apparatus], the command and all parties who were using it should be notified as soon as possible in order to take appropriate measures.

9) When the command is certain that a particular telephone [line] is being monitored, it can exploit it by providing information that misleads the enemy and benefits the work plan.

10) If the Organization manages to obtain jamming devices, it should use them immediately.

Second Means: Meeting in-person: 1/2

This is direct communication between the commander and a member of the Organization. During the meeting the following are accomplished:

- 1) Information exchange,
- 2) Giving orders and instructions,
- 3) Financing,
- 4) Member follow-up

Stages of the In-Person Meeting:

- A) Before the meeting,
- B) The meeting [itself],
- C) After the meeting

A. Before the Meeting:

The following measures should be taken:

- 1) Designating the meeting location,
- 2) Finding a proper cover for the meeting,
- 3) Specifying the meeting date and time,
- 4) Defining special signals between those who meet.

1) Identifying the meeting location

If the meeting location is stationary, the following matters should be observed:

- i) The location should be far from police stations and security centers.
- ii) Ease of transportation to the location.
- iii) Selecting the location prior to the meeting and learning all its details.
- iv) If the meeting location is an apartment, it should not be the first one, but one somewhere in the middle.
- v) The availability of many roads leading to the meeting location. That would provide easy escape in case the location were raided by security personnel.
- vi) The location should not be under suspicion (by the security [apparatus])
- vii) The apartment where the meeting takes place should be on the ground floor, to facilitate escape.
- viii) The ability to detect any surveillance from that location.
- ix) When public transportation is used, one should alight at some distance

from the meeting location and continue on foot. In the case of a private vehicle, one should park it far away or in a secure place so as to be able to maneuver it quickly at any time.

If the meeting location is not stationary, the following matters should be observed:

- i) The meeting location should be at the intersection of a large number of main and side streets to facilitate entry, exit, and escape.
- ii) The meeting location (such as a coffee shop) should not have members that might be dealing with the security apparatus.
- iii) The meeting should not be held in a crowded place because that would allow the security personnel to hide and monitor those who meet.

iv) It is imperative to agree on an alternative location for the meeting in case meeting in the first is unfeasible. That holds whether the meeting place is stationary or not.

Those who meet in-person should do the following:

- i) Verifying the security situation of the location before the meeting.
- ii) Ensuring that there are no security personnel behind them or at the meeting place.
- iii) Not heading to the location directly.
- iv) Clothing and appearance should be appropriate for the meeting location.
- v) Verifying that private documents carried by the brother have appropriate cover.
- vi) Prior to the meeting, designing a security plan that specifies what the security personnel would be told in case the location were raided by them, and what [the brothers] would resort to in dealing with the security personnel (fleeing, driving back, . . .)

2) Finding a proper cover for the meeting [The cover]

- i) should blend well with the nature of the location.
- ii) In case they raid the place, the security personnel should believe the cover.
- iii) should not arouse the curiosity of those present.
- iv) should match the person's appearance and his financial and educational background.
- v) should have documents that support it.
- vi) provide reasons for the two parties' meeting (for example, one of the

two parties should have proof that he is an architect. The other should have documents as proof that he is a land owner. The architect has produced a construction plan for the land)

3) Specifying the Meeting Date and Time

- i) Specifying the hour of the meeting as well as the date.
- ii) Specifying the time of both parties' arrival and the time of the first party's departure.
- iii) Specifying how long the meeting will last.
- iv) Specifying an alternative date and time.
- v) Not allowing a long period of time between making the meeting arrangements and the meeting itself.

4) Designating special signals between those who meet

If the two individuals meeting know one another's shape and appearance, it is sufficient to use a single safety sign. [In that case,] the sitting and arriving individuals inform each other that there is no enemy surveillance. The sign may be keys, beads, a newspaper, or a scarf. The two parties would agree on moving it in a special way so as not to attract the attention of those present. If the two individuals do not know one another, they should do the following:

a) **The initial sign** for becoming acquainted may be that both of them wear a certain type of clothing or carry a certain item. These signs should be appropriate for the place, easily identified, and meet the purpose. The initial sign for becoming acquainted does not [fully] identify one person by another. It does that at a rate of 30%.

b) **Safety Signal:** It is given by the individual sitting in the meeting location to inform the second individual that the place is safe. The second person would reply through signals to inform the first that he is not being monitored. The signals are agreed upon previously and should not cause suspicion.

c) **A second signal** for getting acquainted is one in which the arriving person uses while sitting down. That signal may be a certain clause, a word, a sentence, or a gesture agreed upon previously, and should not cause suspicion for those who hear it or see it.

B. The Stage of the Meeting [itself]

The following measures should be taken:

- 1) Caution during the meeting.
- 2) Not acting unnaturally during the meeting in order not to raise suspicion.
- 3) Not talking with either loud or very low voices ([should be] moderate).
- 4) Not writing anything that has to do with the meeting.
- 5) Agreeing on a security plan in case the enemy raids the location.

C. After the Meeting

The following measures should be taken:

- 1) Not departing together, but each one separately.
- 2) Not heading directly to the main road but through secondary ones.
- 3) Not leaving anything in the meeting place that might indicate the identity or nature of those who met.

Meeting in-person has disadvantages, such as:

- 1) Allowing the enemy to capture those who are meeting.
- 2) Allowing them [the enemy] to take pictures of those who are meeting, record their conversation, and gather evidence against them.
- 3) Revealing the appearance of the commander to the other person.

However, that may be avoided by taking the previously mentioned measures such as disguising himself well and changing his appearance (glasses, wig, etc.)

Third Means: The Messenger:

This is an intermediary between the sender and the receiver. The messenger should possess all characteristics mentioned in the first chapter regarding the Military Organization's member. These are the security measures that a messenger should take:

- 1) Knowledge of the person to whom he will deliver the message.
- 2) Agreement on special signals, exact date, and specific time.
- 3) Selecting a public street or place that does not raise suspicion.
- 4) Going through a secondary road that does not have check points.

- 5) Using public transportation (train,bus,...) and disembarking before the main station. Likewise, embarking should not be done at the main station either, were there are a lot of security personnel and informants.
- 6) Complete knowledge of the location to which he is going.

Fourth Means: Letters:

This means (letters) may be used as a method of communication between members and the Organization provided that the following security measures are taken:

- 1) It is forbidden to write any secret information in the letter. If one must do so, the writing should be done in general terms.
- 2) The letter should not be mailed from a post office close to the sender's residence, but from a distant one.
- 3) The letter should not be sent directly to the receiver's address but to an inconspicuous location where there are many workers from your country. Afterwards, the letter will be forwarded to the intended receiver. (This is regarding the overseas- bound letter).
- 4) The sender's name and address on the envelope should be fictitious. In case the letters and their contents are discovered, the security apparatus would not be able to determine his [the sender's] name and address.
- 5) The envelope should not be transparent so as to reveal the letter inside.
- 6) The enclosed pages should not be many, so as not to raise suspicion.
- 7) The receiver's address should be written clearly so that the letter would not be returned.
- 8) Paying the post office box fees should not be forgotten.

Fifth Means: Facsimile and Wireless:

Considering its modest capabilities and the pursuit by the security apparatus of its members and forces, the Islamic Military Organization cannot obtain these devices. In case the Organization is able to obtain them, firm security measures should be taken to secure communication between the members in the country and the command outside.

These measures are:

- 1) The duration of transmission should not exceed five minutes in order to prevent the enemy from pinpointing the device location.
- 2) The device should be placed in a location with high wireless frequency, such as close to a TV station, embassies, and consulates in order to prevent the enemy from identifying its location.
- 3) The brother, using the wireless device to contact his command outside the country, should disguise his voice.
- 4) The time of communication should be carefully specified.
- 5) The frequency should be changed from time to time.
- 6) The device should be frequently moved from one location to another.
- 7) Do not reveal your location to the entity for which you report.
- 8) The conversation should be in general terms so as not to raise suspicion.

Transportation Means:

The members of the Organization may move from one location to another using one of the following means:

- a) Public transportation,
- b) Private transportation

Security Measures that Should be Observed in Public Transportation:

- 1) One should select public transportation that is not subject to frequent checking along the way, such as crowded trains or public buses.
- 2) Boarding should be done at a secondary station, as main stations undergo more careful surveillance. Likewise, embarkment should not be done at main stations.
- 3) The cover should match the general appearance (tourist bus, first-class train, second-class train, etc).
- 4) The existence of documents supporting the cover.
- 5) Placing important luggage among the passengers' luggage without identifying the one who placed it. If it is discovered, its owner would not be arrested. In trains, it [the luggage] should be placed in a different car than that of its owner.
- 6) The brother traveling on a "special mission" should not get involved in religious issues (advocating good and denouncing evil) or day-to-day matters (seat reservation,...). The brother traveling on a mission should not arrive in the [destination] country at night because then travelers are few, and there are [search] parties and check points along the way.
- 7)
- 8) When cabs are used, conversation of any kind should not be started with the driver because many cab drivers work for the security apparatus.
- 9) The brother should exercise extreme caution and apply all security measures to the members.

Security Measures that Should be Observed in Private Transportation:

Private transportation includes: cars, motorcycles

A) Cars and motorcycles used in overt activity:

- 1) One should possess the proper permit and not violate traffic rules in order to avoid trouble with the police.
- 2) The location of the vehicle should be secure so that the security apparatus would not confiscate it.
- 3) The vehicle make and model should be appropriate for the brother's cover.
- 4) The vehicle should not be used in special military operations unless the Organization has no other choice.

B) Cars and motorcycles used in covert activity:

- 1) Attention should be given to permits and [obeying] the traffic rules in order to avoid trouble and reveal their actual mission.

- 2) The vehicle should not be left in suspicious places (deserts, mountains, etc.). If it must be, then the work should be performed at suitable times when no one would keep close watch or follow it.
- 3) The vehicle should be purchased using forged documents so that getting to its owners would be prevented once it is discovered.
- 4) For the sake of continuity, have only one brother in charge of selling.
- 5) While parking somewhere, one should be in a position to move quickly and flee in case of danger.
- 6) The car or motorcycle color should be changed before the operation and returned to the original after the operation.
- 7) The license plate number and county name should be falsified. Further, the digits should be numerous in order to prevent anyone from spotting and memorizing it.
- 8) The operation vehicle should not be taken to large gasoline stations so that it would not be detected by the security apparatus.

5) SIXTH LESSON - TRAINING

The following security precautions should be taken during the training:

The Place

The place should have the following specifications:

- 1) Distance from the populated areas with the availability of living necessities.
- 2) Availability of medical services during the training.
- 3) The place should be suitable for the type of training (physical fitness, shooting, tactics).
- 4) No one except the trainers and trainees should know about the place.
- 5) The place should have many roads and entrances.
- 6) The place should be visited at suitable times.
- 7) Hiding any training traces immediately after the training.
- 8) Guarding the place during the training.
- 9) Appropriateness of the existing facilities for the number of training members.
- 10) Exclusion of anyone who is not connected with the training.
- 11) Taking all security measures regarding the establishment.
- 12) Distance of the place from police stations, public establishments, and the eyes of informants.
- 13) The place should not be situated in such a way that the training and trainees can be seen from another location.

The Trainees:

- 1) Before proceeding to the training place, all security measures connected with an undercover individual should be taken. Meanwhile, during training at the place, personnel safety should be ensured.
- 2) Selecting the trainees carefully.
- 3) The trainees should not know one another.

- 4) The small size of groups that should be together during the training (7-10 individuals).
- 5) The trainees should not know the training place.
- 6) Establishing a training plan for each trainee.

The Trainers:

All measures taken with regard to the commanders apply also to the trainers. **Also, the following should be applied:**

- 1) Fewness of the trainers in the training place. Only those conducting the training should be there, in order not to subject the training team to the risk of security exposure.
- 2) Not revealing the identity of the trainer to trainees.
- 3) Keeping a small ratio of trainees to trainer.
- 4) The training team members should not know one another.

6) SEVENTH LESSON - WEAPONS: MEASURES RELATED TO BUYING AND TRANSPORTING THEM

Prior to dealing with weapons, whether buying, transporting, or storing them, it is essential to establish a careful, systematic and firm security plan that plan deals with all stages. It is necessary to divide that task into stages:

First Stage: Prior to Purchase;

Second Stage: Purchasing;

Third Stage: Transport;

Fourth Stage: Storage.

1) Prior to Purchase Stage

It is necessary to take the following measures:

- a) In-depth knowledge of the place where weapons will be purchased, together with its entrances and exits.
- b) Verifying there are no informants or security personnel at the place where purchasing will take place.
- c) The place should be far from police stations and government establishments.
- d) Not proceeding to the purchasing place directly by the main road, but on secondary streets.
- e) Performing the exercises to detect the surveillance.
- f) One's appearance and clothing should be appropriate for the place where purchasing will take place.
- g) The purchasing place should not be situated in such a way that the seller and buyer can be seen from another location. To the contrary, the purchasing place should be such that the seller and buyer can see the surrounding area.
- h) Determining a suitable cover for being in that place.
- i) The place should not be crowded because that would facilitate the police hiding among people, monitoring the arms receiving, and consequently arresting the brother purchasing.

- j) In case one of the parties is unable to arrive, it is essential to prearrange an alternative place and time with the seller.
- k) Selecting a time suitable for the purchase so that it does not raise suspicion.
- l) Prior to purchasing, the seller should be tested to ensure that he is not an agent of the security apparatus.
- m) Preparing a place for storage prior to purchasing.

2) The Purchase Stage

- a) Verifying that the weapons are in working condition.
- b) Not paying the seller the price for the weapons before viewing, inspecting, and testing them.
- c) Not telling the seller about the mission for which the weapons are being purchased.
- d) Extreme caution should be used during the purchasing operation in the event of any unnatural behavior by the seller or those around you.
- e) Not lengthening the time spent with the seller. It is important to depart immediately after purchasing the weapons.

3) The Transport Stage

- a) Avoid main roads where check points are common.
- b) Choose a suitable time for transporting the weapons.
- c) Observers should proceed on the road ahead of the transportation vehicle for early warning in case of an emergency.
- d) Not proceeding directly to the storage place until after verifying there is no surveillance.
- e) During the transport stage, weapons should be hidden in a way that they are inconspicuous and difficult to find.
- f) The route for transporting the weapons should be determined very carefully.
- g) Verifying the legality of the vehicle, performing its maintenance, checking its gasoline and water levels, etc.
- h) Driving the car normally in order to prevent accidents.

4) The Storage Stage

- a) In order to avoid repeated transporting, suitable storage places should be selected. In case the materials are bombs or detonators, they should be protected from extreme heat and humidity.
- b) Explosive materials and detonators should be separated and stored apart from each other.
- c) Caution should be exercised when putting detonators in the arsenal.
- d) Lubricating the weapons and placing them in wooden or plastic crates.

The ammunition should be treated likewise. When selecting an arsenal, consider the following:

- 1) The arsenal should not be in well-protected areas, or close to parks or public places.
- 2) The arsenal should not be in a "no-man's-land"

- 3) The arsenal should not be in an apartment previously used for suspicious activities and often frequented by security personnel.
- 4) The arsenal should not be a room that is constantly used and cannot be given up by family members who do not know the nature of the father or husband's work.
- 5) The apartment selected as an arsenal should be owned by the Organization or rented on a long-term basis.
- 6) The brother responsible for storage should not visit the arsenal frequently, nor toy with the weapons.
- 7) The arsenal keeper should record in a book all weapons, explosive materials, and ammunition. That book should be coded and well secured.
- 8) Only the arsenal keeper and the commander should know the location of the arsenal.
- 9) It is necessary to prepare alternative arsenals and not leave any leads in the original arsenals to the alternative ones.

7) EIGHT LESSON- MEMBER SAFETY

Defining Members Safety:

This is a set of measures taken by members who perform undercover missions in order to prevent the enemies from getting to them. It is necessary for any party that has many members to subdivide its members into three groups, each of which has its own security measures. The three groups are:

- 1) The overt member,
- 2) The covert member,
- 3) The commander.

Measures that Should be Taken by the Overt Member:

- 1) He should not be curious and inquisitive about matters that do not concern him.
- 2) He should not be chatty and talkative about everything he knows or hears.
- 3) He should not carry on him the names and addresses of those members he knows. If he has to, he should keep them safe.
- 4) During times of security concerns and arrest campaigns and especially if his appearance is Islamic, he should reduce his visits to the areas of trouble and remain at home instead.
- 5) When conversing on the telephone, he should not talk about any information that might be of use to the enemy.
- 6) When sending letters, he should not mention any information that might be of use to the enemy. When receiving letters, he should burn them immediately after reading them and pour water on them to prevent the enemy from reading them. Further, he should destroy any traces of fire so the enemy would not find out that something was burned.

Measures that Should be Taken by the Undercover Member:

In addition to the above measures, the member should...

1) Not reveal his true name to the Organization's members who are working with him, nor to the [Islamic] Da'wa [Call].

2) Have a general appearance that does not indicate Islamic orientation (beard, toothpick, book, [long] shirt, small Koran).

3) Be careful not to mention the brothers' common expressions or show their behaviors (special praying appearance, "may Allah reward you", "peace be on you" while arriving and departing, etc.)

4) Avoid visiting famous Islamic places (mosques, libraries, Islamic fairs, etc.) Carry falsified personal documents and know all the information they contain.

5)

6)

7)

8)

9) Not resort to utilizing letters and messengers except in an emergency.

Have protection preceding his visit to any place while moving about (apartment, province, means of transportation, etc.). Have complete and accurate knowledge of the security status related to those around him in his place of work and residence, so that no danger or harm would catch him unaware. Maintain his family and neighborhood relationships and should not show any changes towards them so that they would not attempt to bring him back [from the Organization] for security reasons.

10) Not speak loudly.

11) Not get involved in advocating good and denouncing evil in order not to attract attention to himself.

12) Break the daily routine, especially when performing an undercover mission. For example, changing the departure and return routes, arrival and departure times, and the store where he buys his goods.

13) Not causing any trouble in the neighborhood where he lives or at the place of work.

14) Converse on the telephone using special code so that he does not attract attention.

15) Not contacting the overt members except when necessary. Such contacts should be brief.

16) Not fall into the enemy's excitement trap, either through praising or criticizing his Organization.

17) Performing the exercises to detect surveillance whenever a task is to be performed.

18) Not park in no-parking zones and not take photographs where it is forbidden.

19) Closing all that should be closed before departing the place, whether at home or his place of undercover work.

20) Not undergo a sudden change in his daily routine or any relationships that precede his Jihad involvement. For example, there should not be an obvious

change in his habits of conversing, movement, presence, or disappearance. Likewise, he should not be hasty to sever his previous relationships.

21) Not meet in places where there are informers, such as coffee shops, and not live in areas close to the residences of important personalities, government establishments, and police stations.

22) Not write down on any media, specially on paper, that could show the traces and words of the pen by rubbing the paper with lead powder.

Measures that Should be Taken by the Commander:

The commander, whether in overt or covert work, has special importance for the following reasons:

- 1) The large amount of information that he possesses.
- 2) The difficulty of the command in replacing the commander.
- 3) Therefore, all previously mentioned security precautions regarding members should be heightened for the commander. Many resources should be reserved for protecting the commanders.

Importance of Information:

1) Based on the enemy's up-to-date information, his capabilities, and plans, the Organization's command can design good-quality and secure plans. [7] Abdullah Ali Al-Salama: Military Espionage in Islam, pp. 253-258.

2) Information about the enemy's intention provides early warning signs for the command, which in turn makes appropriate preparation and thwarts the enemy's opportunity.

3) Information benefits the Organization's command by providing information about the enemy's strengths and weaknesses.

4) Information benefits the Organization's command by providing information about movements of the enemy and his members.

Information requirements include:

Newness, Trustworthiness, Forthcoming, security, and confirmation. General Mahmoud Sheet Khattab said, "The nation that wants to achieve victory over its enemy must know that enemy very well. It also must know the site of the battle in detail. Those who fight an enemy that they do not know, do not win because a successful military plan must be built on clear and trustworthy information. The commander who fights an enemy and does not know his strength (number and material) is blind and destined to fail and fall.

Information Sources:

Any organization that desires to raise the flag of Islam high and proud, must gather as much information as possible about the enemy. Information has two sources:

1) Public Source: Using this public source openly and without resorting to illegal means, it is possible to gather at least **80% of information** about the enemy. The percentage varies depending on the government's policy on freedom of the press and publication. It is possible to gather information through newspapers, magazines, books, periodicals, official publications, and enemy broadcasts. Attention should also be given to the opinion, comments, and jokes of

common people. Truman, a past American President, said, "We attribute our great advance to our press, because it gives America's enemies the capability of learning what we have not officially publicized about our plans and even our establishments." In 1954, Allan Dulles [PH], Director of American Intelligence [CIA], said, "I am ready to pay any amount of money to obtain information about the Soviet Union, even as little as what the Soviet Union obtains by simply reading American newspapers."

The one gathering public information should be a regular person (trained college graduate) who examines primary sources of information published by the enemy (newspapers, magazines, radio, TV, etc.). He should search for information directly related to the topic in question. The one gathering information with this public method is not exposed to any danger whatsoever. Any brother can gather information from those aforementioned sources. We cannot label that brother a "Moslem Spy" because he does not make any effort to obtain unpublished and covert information.

2) Secret Sources: It is possible, through these secret and dangerous methods, to obtain the **20% of information** that is considered secret. The most important of these sources are:

- A. Individuals who are recruited as either volunteers or because of other motives
- B. Recording and monitoring
- C. Photography
- D. Interrogation
- E. Documents: By burglary or recruitment of personnel
- F. Drugging
- G. Surveillance, spying, and observation

Information Gathering Using Public Means:

A. Newspapers, Magazines, and Official and Party Publications:

In order to gather enemy information, the Military Organization can use means such as magazines, publications, periodicals, and official printed matter. Through these means, it is possible to learn about major government events and about the news, meetings, and travel of Presidents, ministers, and commanders. Information may be:

- 1) Names and photographs of important government personalities, police commanders, and security leaders.
- 2) Published meetings. Through these, one can learn about major decisions and topics being discussed.
- 3) Future meeting plans.
- 4) Present and future enemy capabilities through current photographs of projects and strategic sites or through meetings with top officials.
- 5) Beneficial news about the enemy's diplomacy and its present and future plans.
- 6) Tourism news and the arrival times of foreign tourist groups.

- 7) Advertisements about apartments for rent, vacant positions, or anything else that is useful.
- 8) Advertisements about new and used car lots. These may be used in assassination, kidnaping, and overthrowing the government.
- 9) Learning the enemy position on current Islamic issues (veil, beard, dedication, Jihad, ...).

B. Radio and Television:

The Military organization can use these important public sources to gather information all day and night. The importance of these means is explained below.

- 1) Visual and audible news help the Organization to determine its present and future plans.
 - 2) Interviews may help to identify the government policy and its general directives.
 - 3) Spotting the appearance of those who occupy high positions.
 - 4) Learning the prevailing information diplomacy and its position on contemporary issues.
 - 5) Learning about the interior of important government places and establishments during their opening ceremonies or through advertisements.
- In addition to the aforementioned, [attention should be given] to newspapers, magazines, and the public's comments and jokes.

8) TWELFTH LESSON - ESPIONAGE

INFORMATION-GATHERING USING COVERT METHODS

Information needed through covert means: Information needed to be gathered through covert means is of only two types:

First: Information about government personnel, officers, important personalities, and all matters related to those (residence, work place, times of leaving and returning, wives and children, places visited)

Second: Information about strategic buildings, important establishments, and military bases. Examples are important ministries such as those of Defense and Internal Security, airports, seaports, land border points, embassies, and radio and TV stations.

General security measures that should be taken by the person gathering information:

During the process of gathering information, whether about governing personalities or establishments, the person doing the gathering must take the following security measures:

- 1) Performing the **exercises to detect surveillance** while executing the mission. These exercises are not well defined, but are dependent on the time, place, and the ability to be creative. These exercises include the following:
 - a)
 - b)
 - c)
 - d)

e) Walking down a dead-end street and observing who is walking behind you. Beware of traps. Casually dropping something out of your pocket and observing who will pick it up. Walking fast then stopping suddenly at a corner and observing who will be affected. Stopping in front of store windows and observing who is-watchingyou. Getting on a bus and then getting off after it departs and observing who will be affected.

f) Agreeing with one of your brothers to look for whoever is watching you.

2) When **receiving the gathered information**, let the informants travel as far as possible from their place of residence and yours. Let each of them get there using secondary roads, preferably at night.

3) Gather what information you can without emphasizing any particular part. Do not rush or show urgency because your excitement may uncover you and the degree of importance of the information.

4) Avoid anything that reveals your identity quickly. Do not attempt to be too creative or inventive. Remember what Taliran [PHI said to his political emissaries, "Do not be anxious."

5) Move slowly and travel a great distance. The one who is successful in gathering information is the one who is not known or conspicuous.

6) Do not accept events at their face value. Do not overlook a quick friendship or an apparent dispute. Evaluate the importance of events and do not judge them by their appearance.

7) Do not speak vaguely or act mysteriously except when wanting to get a "blabber mouth" to talk about what he knows.

8) Carry personal credentials and know all their contents.

9) Prior to collecting the information, make sure that all necessities related to the mission, especially money, are ready.

10) Study the area where information-gathering takes place carefully:

Open and closed streets, residents' customs, ways of dressing, and accent.

11) It is not permitted to carry any weapons during the information-gathering process.

12) Finding a cover prior to gathering the information. Further, review all security measures concerning members of the Military [Organization] which are covered in prior lessons.

Methods of Gathering Information Using Covert Means:

The Military Organization may obtain secret information using: A. Surveillance, intelligence, and observation; B. Theft; C . Interrogation; D. Excitement; E. Drugging; F. Recruitment.

A. Surveillance, Intelligence, and Observation: Civilian and military targets (personalities). The monitoring may be done on foot or by car.

Surveillance on foot:

- 1) The brother or brothers performing the surveillance operation on foot study the available information about the target (height, weight, way of walking, looking at a recent photograph)
- 2) Knowing the target's habits, places he visits, and communications
- 3) Studying carefully the area where observation will take place: names of through and dead-end streets, residents' habits and way of dressing.
- 4) Prior to the start of the surveillance mission, making sure that all needs related to the mission, especially money, are met.
- 5) Agreeing on how communications with the leaders will take place in case the surveillance plan is uncovered (telephone, a person used for that purpose). The telephone number should not be written but memorized.
- 6) Agreeing on special signals to exchange orders and instructions among the surveillance team members.
- 7) Knowing the measures to be taken when the target is lost, such as contacting the leaders or something else agreed upon.
- 8) It is not permitted to carry any weapons during the information-gathering process.
- 9) It is preferable to have a camera with the surveillance man in case the target is to personally contact others.

Surveillance by car:

Surveillance by car requires taking certain measures:

- 1) Inspecting the car's fuel, water, and lights.
- 2) The car should be of a common type so it would not attract people's attention.
- 3) The car should be in good condition and the driver should be experienced.
- 4) The car plates should not contain real numbers. It is important to use a false license plate and small numbers in order to prevent anyone from spotting and memorizing it.
- 5) The car's interior light should be disabled in order to hide the identity of the surveillance team members sitting inside.
- 6) The number and appearance of the car surveillance team members should match those of the target's car.

Performing Surveillance by Car:

- 1) The car being used for surveillance should keep up with the target's car during the surveillance operation, especially in crowded areas and on side streets. The distance between the two cars depends on the circumstances.
- 2) If the target gets out of his car and starts to walk, one of the surveillance team members should get out and observe him.
- 3) Follow all aforementioned measures for surveillance on foot.

Exercises to detect surveillance by car:

- 1) The surveillance car speeds up then stops suddenly while observing which other car is affected (this is done where there is not a lot of traffic).
- 2) The surveillance car enters a dead-end street.
- 3) The surveillance car goes in the opposite direction of traffic.
- 4) The surveillance car stops and goes backwards.
- 5) [The surveillance car] enters a parking lot and immediately goes out.
- 6) [The surveillance car] takes a side road and stops.

Surveillance, Intelligence, and Observation (Information about the enemy places)

The Organization's command needs detailed information about the enemy's vital establishments, whether civilian or military, in order to make safe plans, reach firm decisions, and avoid surprises. Thus, the individual who gathers information about a desired location should, in addition to drawing a diagram, describe it and all its details.

The Drawing: The brother should draw a diagram of the area, the street, and the location which is the target of the information-gathering. He should describe its shape and characteristics. The drawing should be realistic so that someone who never saw the location could visualize it. It is preferable to also put on the drawing the directions of traffic, police stations, and security centers.

The Description: It is necessary to gather as much information about the location as possible. For instance:

- 1) Traffic directions and how wide the streets are
- 2) Transportation leading to the location
- 3) The area, appearance, and setting of the place
- 4) Traffic signals and pedestrian areas
- 5) Security personnel centers and government agencies
- 6) Embassies and consulates
- 7) The economic characteristics of the area and traffic congestion times
- 8) Public parks
- 9) Amount and location of lighting

It is preferable to photograph the area as a whole first, then the street of the [desired] location. If possible, panoramic pictures should be taken. That is, the collection of views should be continuous in a such way that all pictures are taken from one location and that the ending of one picture is the beginning of the next. The photographer should be experienced with and proficient in film processing and developing. It is risky to use an outside film processing service. When observing a military installation or camp, we discourage taking pictures where it is forbidden. The brother/photographer should use a modern camera that can photograph at night or from a distance, and only the lens of the camera should be visible. When gathering information about a military camp, the brother should draw a diagram of the camp's overall area, the camp itself, and its interior, if possible

The description of the base or camp must contain the following:

- 1) Location
- 2) Exterior shape
- 3) Transportation to it
- 4) Space [area]
- 5) Weapons used
- 6) Unit using the camp
- 7) Fortifications and tunnels
- 8) Guard posts
- 9) Amount and periods of lighting
- 10) Number of soldiers and officers. Officers' ranks
- 11) Ammunition depot locations
- 12) Vehicles and automobiles
- 13) Leave policy
- 14) Commander's name, rank, arrival and departure times
- 15) Degree and speed of mobilization
- 16) Brigades and names of companies
- 17) Sleeping and waking times
- 18) Telephone lines and means of communication

The brother gathering the information may start a friendship with one of the soldiers or officers of that base. Information may be collected gradually and easily from soldiers when giving them rides from the camp to the bus or train stations, etc.

Gathering Information Through Interrogation:

Security personnel in our countries arrest brothers and obtain the needed information through interrogation and torture.

The Military Organization must do likewise. On one hand, the Organization can obtain important information about enemy establishments and personnel. On the other hand, that is a form of necessary punishment. Information is collected in this method by kidnaping an enemy individual, interrogating him, and torturing him. This source of information is not permanent. Also, caution should be exercised about being deceived by misinformation from enemy individuals.

Thus, the brother who interrogates the hostage should possess the following characteristics:

- 1) Should have knowledge and expertise about people's behavior and morals.
- 2) Should have a strong personality.
- 3) Should possess a sixth sense based on practice and experience.
- 4) Should be extremely patient.
- 5) Should be able to act, pretend, and mask himself.
- 6) Should be intelligent, observant, analytical, and deductive.
- 7) Should be able to establish an investigative plan.

Gathering Information

Through Recruitment:

Recruiting agents is the most dangerous task that an enlisted brother can perform. Because of this dangerous task, the brother may be killed or imprisoned. Thus, the recruitment task must be performed by special types of members. There are a number of motives that might entice an uncommitted person to take part in intelligence work.

These motives are:

- 1) Coercion and entanglement
- 2) Greed and love for money
- 3) Displaying courage and love of adventure
- 4) Love of amusement and deviance
- 5) Mental and political orientation
- 6) Fear of being harmed

The Organization may use motives No. 2, 3, 5, and 6 in recruitment.

Summary of Books and Guides of the Enemy:

Rules for Radicals – Saul Alinsky

Das Kapital – Karl Marx

The Little Red Book – Mao Zedong

„Open Society“ Strategy Documents

United Nations Agenda 21, 2030 etc.

The Protocols of the Elders of Zion (unclear origin but nevertheless studied by the Enemy)

XIII. War Tactics and Background Knowledge from Neutral, Historical or Allied Sources

The following list of books is recommended as background information for the more knowledge hungry leadership forces:

100 Years Together – Alexander Solzhenitsyn
The International Jew – Henry Ford
On War – General Carl von Clausewitz
The Art of War – Sun Tzu
New Lies for Old – Anatoliy Golitsyn
Decline of the West – Oswald Spengler
Hitler's Revolution – Richard Tedor

Online Resources and Databanks³:

IT IS A PRIORITY TO SAVE THESE RESOURCES AND COPY THEM SO THAT THE DATA IS MIRRORED OFFLINE. DO NOT ACCESS THESE RESOURCES WITHOUT INITIAL OPSEC PRECAUTIONS OR FULL COMMITMENT TO THE CAUSE. It is ideal that this manual be given to you in a printed version, although you should remain calm, focused and determined until the final victory if it has been given to you via an online source.

0) <https://archive.org/download/MEGA-Dokument>

This is the largest weapons and war related archive on the internet. If you download nothing else then download this.

1) <https://archive.org/details/military-manuals>

Military Manuals - booby traps, improvised munitions, unconventional warfare devices and techniques, marksmanship and ballistics

2) <https://8ch.net/pdfs/res/6071.html#9096>

The Terrorist's Handbook – A definitive guide by CHAOS to manufacturing many materials needed for active resistance measures. Do not let the name confuse you, as an SS member your aims are noble and your motives pure. Terror is not to be strived towards, rather victory is. **Do not allow your enemy to label you as a terrorist thereby granting them power.** If seeking a name for this handbook in discussion it is recommended to frame it as „Resistance

3 Warning: these resources should be downloaded and stored on a safe medium preferably in a radiation proofed room (i.e. Faraday cage, concrete walled basement or bunker). The enemy has been attacking archival services and therefore the saving of online resources is to be prioritized.

Fighter“ or „Freedom Fighter“ Handbook.

3)

<https://web.archive.org/web/20080302034604/http://www.bellum.nu:80/literature/tacayan.html>

CIA psyops in guerilla warfare.

4)

<https://web.archive.org/web/20080228200118/http://www.bellum.nu:80/literature.html>

Classic tomes on **conventional warfare theory**, modern ones on guerilla warfare tactics

5) <https://8ch.net/k/res/480825.html#557006>

Scientific Principles of Improvised Warfare and Home Defense, Volumes 1-6

6) <https://8ch.net/k/res/480825.html#555519>

To Break a Tyrant's Chains

7) <https://8ch.net/k/res/480825.html#480994>

Rhodesian Drake Shooting

8) <https://www.survivalschool.us/survival-info/military-manuals-pdf/>

Almost every **U.S. ZOG Field Manual and Training Manual**

9) <https://archive.fo/rs0om>

A summary and discussion of many of the above resources.

10) <http://www.survivorlibrary.com/library-download>

Further reading on survival and relevant guides

11) <https://fas.org/irp/doddir/army/fm3-0.pdf>

Overall US Army Doctrine

12) [http://www.bits.de/NRANEU/others/amd-us-archive/fm3-](http://www.bits.de/NRANEU/others/amd-us-archive/fm3-06.11%2802%29.pdf)

[06.11%2802%29.pdf](http://www.bits.de/NRANEU/others/amd-us-archive/fm3-06.11%2802%29.pdf)

Urban Warfare Doctrine

This list can be extended or shortened as a result of personal research into the topics mentioned.

Lectures and video materials

There are many videos online digging into the details of the great ills of the modern era and the glory of the National Socialist worldview. Here is a brief selection. Also consider seeing censored videos by brilliant creators such as NSTruth1488 and Alerta Judiada on this great archive: <https://www.altcensored.com>

The Jewish Role in the Porn Industry

<https://www.youtube.com/watch?v=WSGAC3JiZlY>

The Majdanek Gas Chamber Myth

<https://www.youtube.com/watch?v=nDVNrldo2tM>

Questioning The Holocaust Why We Believed Part 1 of 2

<https://www.youtube.com/watch?v=pYuW2m6kMOQ>

Auschwitz Why The Gas Chambers Are A Myth full

https://www.youtube.com/watch?v=JCcn84n_gWk

Robert Faurisson Germans Punished in World War II for Mistreating Jews

<https://www.youtube.com/watch?v=vr0TvYj2cVg>

The Holocaust Unveiled Persecution of Revisionists full

<https://www.youtube.com/watch?v=o4ammLr-6ps>

Judea Declares War On Germany A Critical Look at WWII

<https://www.youtube.com/watch?v=bTDZZBfnjAA>

Do The Jews Rule By Proxy?

https://www.youtube.com/watch?v=_crsmiVGUXU

The Royals: Royal Family Secrets Revealed [Full Documentary]

<https://www.youtube.com/watch?v=NUfJXdMIRGw>

History Of The Crypto Jewish Saudi Royal Family | Trump Saudi Russian Connection(CNP Thread)

<https://www.youtube.com/watch?v=lvdrJVIAHDM>

Jordan Peterson and The JQ (Mirror)

<https://www.youtube.com/watch?v=gyXO3H7y6u0>

The Jerusalem Conspiracy

<https://www.youtube.com/watch?v=syUSQEUPTTQ>

The Zionist Plan to Take Over the World

<https://www.youtube.com/watch?v=ZHZPLvbhLh8>

FLASHBACK: The War on Terror Origins w/ Know More News

<https://www.youtube.com/watch?v=vHA7zcXW-AI>

The Truth About Anti-Semitism

<https://www.youtube.com/watch?v=-RNF2GnDP4o>

NEW Documentary Zionism EXPOSED! The Lobby - USA Full 2018 The Electronic Intifada

<https://www.youtube.com/watch?v=JKVNRHLpu9A>

HOW ISRAEL RULES — Barbarians Inside The Gates [Brendon O'Connell Mirror]

<https://www.youtube.com/watch?v=31YVmFpECec>

Jews or Khazars? Exposing the Serpent's Seed!

<https://www.youtube.com/watch?v=LqV7b2ggw0g>

God's Chosen People [KMN Mirror] Full Documentary Zionism Exposed!

<https://www.youtube.com/watch?v=mAps4bwBP4E>

The Jewish question [Crucifixion, Holocaust, Israel]

<https://www.youtube.com/watch?v=HCy0UMjfnRM>

Goy Guide to World History

<https://www.youtube.com/watch?v=Vz6nK9TtYfM>

PEOPLE REALLY AREN'T THAT STUPID (once they are told the truth)

<https://www.youtube.com/watch?v=w6JsvECMaLQ>

The Occupation of the American Mind (original 84-minute version)

<https://www.youtube.com/watch?v=dP0-YohJR-g>

The Jewish Question: an Empirical Examination

<https://www.youtube.com/watch?v=lh4MSZjhdoU>

William Pierce Interview: Race And Reality 1993

<https://www.youtube.com/watch?v=Af7Oqmh-Td8>

Ernst Zundel Interviewed by an Israeli journalist 1996 GREAT !!!

<https://www.youtube.com/watch?v=XOXBVrhOWaM>

David Irving Examines The Holocaust

<https://www.youtube.com/watch?v=7QahWRYSRy>

XIV. Nerve Gas

What exactly is nerve gas? Well, to be brief about it, it's bug spray for people! It is closely related to those organophosphorus compounds used so widely as insecticides. It is also not a gas, but rather a liquid with a very high boiling point. To be used to gas an area, it must be dispersed into the air as an aerosol like out of a spray can. It can also be dispersed as a mist in the air by detonating an explosive charge in it. When done correctly, both methods work well, although the aerosol spray can has the obvious advantage of stealth. This is not to say that the explosive method of dispersing it is without its merits. An explosion is always great for bringing out crowds of curious onlookers into the open, where they can easily fall victim to the effects of the gas.

Nerve gas is a generic term which covers several related substances. All of them have an atom of phosphorous at their heart, with a variety of other chemical groupings attached to the phosphorous atom, depending upon the particular nerve agent. The simplest, and in several ways the best method for dispersing nerve agents over a target is by a technique I call "blast dispersion" for lack of a better name. It is the same principle that works in the nerve-gas artillery shell. A charge of explosive is used to heave the poison into the air and disperse it into a cloud of fine droplets which can then drift downwind over the target. The actual design of a nerve-gas bomb should have the explosive charge in the center of the mass of nerve agent. Naturally, it would not do to have a stick of dynamite floating around in a jug of Sarin, and the active ingredient splashing all over the attackers. Instead, three 40-ounce beer bottles could be taped together in a triangular pattern, and a stick of dynamite placed in the center space between the three bottles (a variant on a gasoline bottle + thermite bomb).

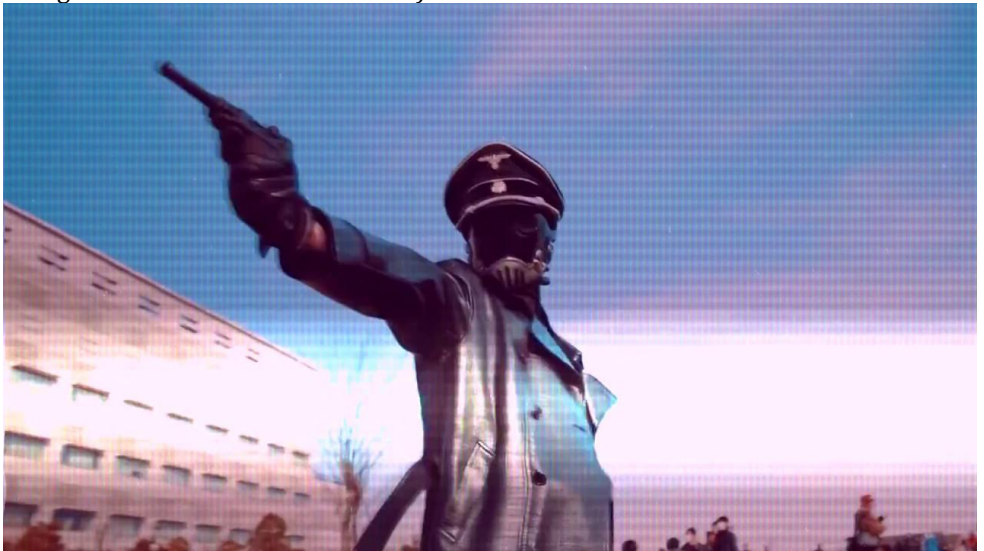

Synthesis and Handling of Nerve Gas



The synthesis of nerve gas is not a project to be undertaken lightly. It is one of the most dangerous projects which can be done in the laboratory. The danger comes from the fact that a little bit on the skin translates into a miserable death minutes later. Beginners at organic synthesis are notorious for spilling the things they are cooking onto themselves, so this is a job for a seasoned veteran. For this reason, a certain amount of chemical expertise will be assumed in the following section. It is meant to be fully understood by anyone who has made it through a couple semesters of college-level organic chemistry.

The equipment needed for production of nerve gas is basically the same as that needed to produce any other of a wide range of organic chemicals. The standard distilling kit with a variety of sizes of round-bottom flasks is a must, as is a magnetic stirrer-hotplate and a good source of vacuum such as a properly working aspirator.

Defenses against Nerve Agents

Protection against nerve agents usually involves creating physical barriers against exposure to the chemicals and reacting them to less toxic forms with moisture and chemicals. Full body protective suits in combination with gas masks or scuba gear prevent contact with skin surfaces or breathing in the agent. Washing off the suits in a shower before taking them off reduces potential exposure from residues.

For ordinary citizens, the only available protection is usually a gas mask. This can be supplemented with a number of field improvised protections.

- 1) Vaseline can be used to provide a barrier against liquid and gas agents (but not the dust). Mixing diatomaceous earth with the Vaseline will provide a highly reactive silica source for detoxifying Sarin and other phosphonofluoridate weapons. Many other nerve agents can be reacted out by adding various chlorine compounds such as the swimming pool hypochlorite granules on separate layers outside the Vaseline or clothing. The chlorine reacts with most nerve agents. Care must be taken to make sure that it is not applied into the layer next to the skin because it causes skin burns.
- 2) Using the gas mask filter in combination with a fan to produce a positive flow filtered air environment in a room or the inside of a car. A fan draws air into the vehicle through the mask filter which reacts out the nerve agents. The clean air then pushes out and displaces the air in the vehicle through the cracks and crevices. This prevents the toxic gas from seeping into your protected environment.

Gas Masks

Military gas masks are designed with filter pads (six core layers laminated between two packing layers) composed of viscose rayon, vinyon, and glass fibers. The core layers are impregnated with 75% Whetlerite which is a finely ground activated carbon which has been immersed in a solution of ammoniacal solution of silver, copper, chromium, and carbon dioxide. It is then dried at temperatures high enough to drive off ammonia from the resulting granules. This formula provides complete protection against all known military toxic chemical agents but does not protect against some industrial toxics like ammonia and carbon monoxide.

Fume respirator and gas mask cannister usually use special materials for each chemical class they encounter. They are available from most safety supply companies. The filter generally contains a particulate layer as well as layers impregnated with chemicals to react with and neutralize the toxic air weapon in question. **When the chemical in the mask is used up, it is possible for the air delivered poison to pass through the mask. This requires that the wearer of the mask will reach a safe area to remove and replace the filter cannisters periodically.**

Improvised masks can be quickly made up using handkerchiefs or other cloth soaked in solutions of activated finely ground charcoal and baking soda. This offers some temporary protection against many acids, bases and other toxic gases.



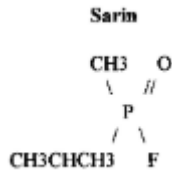

GB (Sarin) Isopropyl Methyl Phosphonofluoridate

SOURCE - Synthesis in good chemical laboratory.

FORM - Thin oily liquid, clear to amber in color, odorless. BP 158°C.

MOLECULAR WEIGHT - 140.9

HANDLING - Avoid inhalation, ingestion, or skin contact. Handle only in a glove box equipped with decontamination apparatus. A good military gas mask should be available.

DOSAGE - Very low through all routes. Inhalation dosage is 10 mg. Oral dose is about half of that. Skin absorption dose is about 1500 mg due to the volatility of the compound. If GB is mixed with an equal amount of DMSO it will absorb through the skin before it can evaporate. If pure GB comes into contact with a cut or abrasion on the skin, absorption will be rapid.

SYMPTOMS - Pinpoint pupils, dim vision, runny nose, tightness in the chest, nausea, diarrhea, coma, and respiratory failure. Death usually occurs in from 1 to 10 minutes, depending on the concentration. Non-lethal doses are usually followed by complete recovery in from 1 to 3 days. However, doses are cumulative if received over a period of a few days.

DETAILS • GB is the second of the nerve gases developed by the Germans in WWII. It is now the standard nerve agent of the United States, being stored both in bulk and loaded into various munitions. The synthesis of GB is fairly straightforward, but extremely dangerous for anyone not intimately familiar with organic chemistry procedure. Many of the chemicals used are hazardous in their own right. One explodes on contact with water, another is an anesthetic gas at normal temperatures. All chemicals and processes should be thoroughly investigated before synthesis is attempted. All safety measures must be strictly adhered to if explosion or accidental poisoning are to be avoided. Frankly, there are safer toxins of greater power available. A good mixture which approaches GB in toxicity is a 50/50 mix of the insecticide Parathion and DMSO. This is more practical for small scale applications and penetrates the skin much faster than pure GB. **Sarin boils at around 200 C and is usually delivered as mists or may be volatilized by hot bursting charges.**

Sarin Production

- 1) 133.3 grams of anhydrous aluminum chloride and 137.4 grams of phosphorus trichloride together in a Pyrex glass pressure bottle, seal and shake mechanically for one hour or until all of the aluminum chloride is dissolved.
- 2) Heat to 60* C in a hot water bath.
- 3) Cool the flask in a dry ice/acetone bath and add 50.5 grams of precooled methyl chloride, seal as before and place in a heavy walled steel pipe with screw caps (this is important, as explosions occasionally occur during this step). Allow to come to room temperature.
- 4) Place the pipe in a mechanical shaker for one minute. When it is removed and opened the reaction mixture should have solidified into a colorless cake.
- 5) Dissolve the cake in 700 cc of methylene dichloride and cool to -20 * C in a dry ice/acetone bath. Add ten 5 cc portions of water, shaking vigorously between additions.
- 6) Filter out the solids.
- 7) Add mixture to a separatory funnel and drain off the lower (water) layer.
- 8) Place the liquid in an evaporating dish on a hot water bath and drive off the solvent. Add the resulting crystals to a minimum amount of hot methylene dichloride. Let cool and the crystals will come out of the solvent producing methylphosphonodichloridate (dichlor), which has a melting point of 33 " C.
- 9) 60% of the dichlor is placed in a flask containing enough methylene dichloride to dissolve it. A gas diffusion tube is installed and dry hydrogen fluoride gas is passed through for approximately one hour. In this manner the dichlor is converted in methylphosphonodifluoridate (difluor). Remove the solvent on a hot water bath.
- 10) Equimolar quantities of dichlor (MW 132.91) and difluor (MW 100.01) are dissolved in methylene dichloride and heated to reflux temperature in a three-necked flask equipped with a reflux head, a stir motor, and a dropper. An equimolar quantity of inopropanol (MW 60.11) is added dropwise with stirring at a rate sufficient to keep the mixture boiling gently. Reflux for one hour after the last of the inopropanol is added.
- 11) Remove the reflux head, hook up a vacuum source with solvent trap and evaporate the solvent under reduced pressure. Warning - The product is now crude Sarin and must be handled accordingly.
- 12) Set up a distillation rig for fractional distillation under vacuum and distill the liquid at 11 mm of pressure. Sarin is the fraction collected at 49.5 * C. Yield is roughly 70 grams.

Alternative approaches to manufacturing Sarin:

is made from methyl-phosphonic dichloride

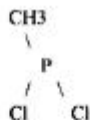

The first step is to directly mix isopropyl alcohol directly with the methyl phosphonic dichloride.

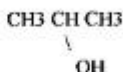

This will take several hours to complete the reaction with stirring and heating.

After the ester is ready (no further reaction), hydrogen fluoride or sodium fluoride may be reacted to yield the Sarin directly. This is one of the deadliest nerve agents known and has been produced in Germany in WW2, by both the US (called GB) and the Soviet Union. It has also been produced and possibly used by Iraq.

Alternative routes to manufacture Sarin include reacting Sodium Fluoride with the methyl-phosphonic dichloride first and then mixing in the isopropyl alcohol.

More recipes for Sarin:

Sarin was made in Germany during World War II by the following process:

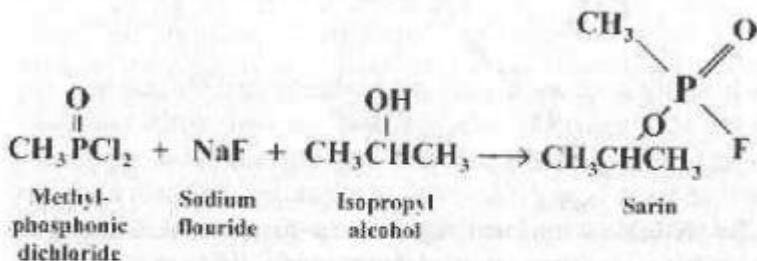

This method was workable, although the yields were low and the product was always contaminated with byproducts. Purity is next to Godliness even in nerve gas! This process could still be made to work today, since the starting material, methylphosphonic dichloride, is commercially available at the moment. It has to be a very suspicion-arousing material if anybody in the chemical industry has something on their minds other than dope. The price of a kilo is about \$60. Directions for making it can be found in the *Journal of the Chemistry Society of London* page 3437 (1952).

This process is described in detail by Schrader himself in *British Intelligence Objectives SubCommittee*, Volume 714, page 41 (1947).

A much better, although more tedious, process was reported in 1960 by a couple of Britishers named Ford-Moore and Bryant. The method they devised was not a simple "one-pot" process like the one that Schrader came up with. It is multi-step, with purification of each intermediate required. Their method is outlined below:

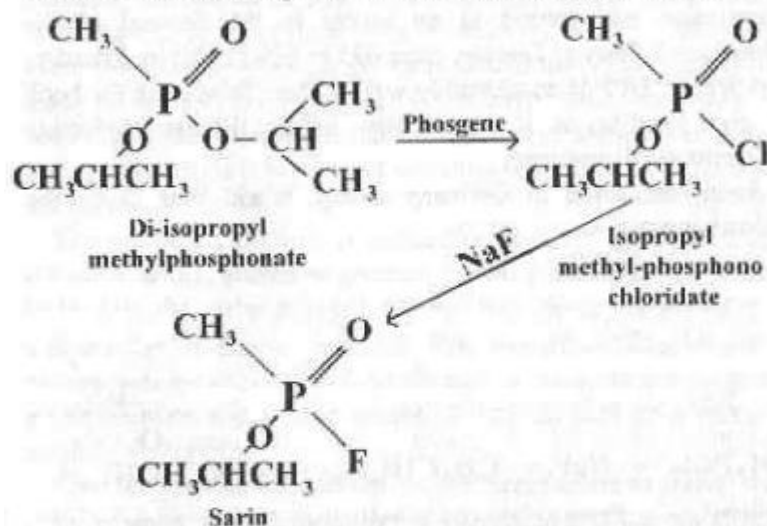

To the best of my knowledge, neither di-isopropyl methylphosphonate nor isopropyl methylphosphonochloridate are available commercially. This means that the process must start with cooking up a good supply of di-isopropyl methylphosphonate. Luckily, excellent directions for cooking it up can be found in *Organic Syntheses*, Volume 31, pages 33 to 35. The authors are Ford-Moore and Perry. It will not be reprised here because *Organic Syntheses* can be found in any good library, and the cooking directions in it are always so clear and reliable that one can place his utmost trust in them.

Now for the production of nerve gas. The glassware is set up as shown in the drawing on the next page.

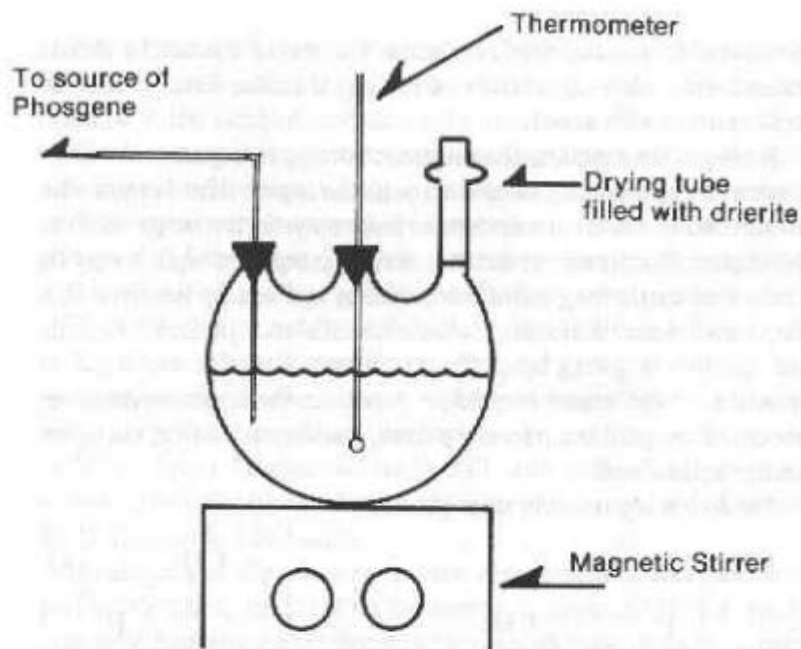

A 3-necked 1000 ml round-bottom flask is set up in the hood on a magnetic stirrer. Into the flask is placed 300 grams (304 ml) of di-isopropyl methylphosphonate. The flask should be baked in an oven for a few hours before use to drive out traces of moisture from the glass. This is very important for all glassware used in all phases of nerve-gas production because water reacts more easily with these chemicals than the desired reaction.

A drying tube is attached to one of the three necks. It is filled with drierite. NaOH should not be used because phosgene reacts with it. A magnetic stirring bar is put into the flask, and a thermometer is put down the central neck into the chemical in the flask to monitor its temperature. It is best held in place with an all-glass thermometer holder, but a cork may be used in a pinch. The use of rubber in any part of this assembly is to be avoided because phosgene attacks it, and will cause its remains to flow into the product. Through the third neck is put a section of glass tubing

connected to a cylinder of phosgene. The end of the tubing should extend well below the surface of the liquid in the flask. It may be held in place with a cork.

To begin the reaction, the magnetic stirring is begun, and a slow stream of phosgene is bubbled through the liquid. The thermometer is watched to make sure the temperature stays in the range of 20 to 30 degrees Centigrade. If the temperature creeps too high, it may be controlled by slowing down the bubbling and setting the flask in a bit of cool water. It is wise to check the efficiency of the hood while the reaction is going by puffing a cigarette outside the hood. It should suck the smoke in quickly. Smoke in the hood should never escape. Phosgene is a vicious poison; see the section on phosgene earlier in this book.

The following reaction takes place:

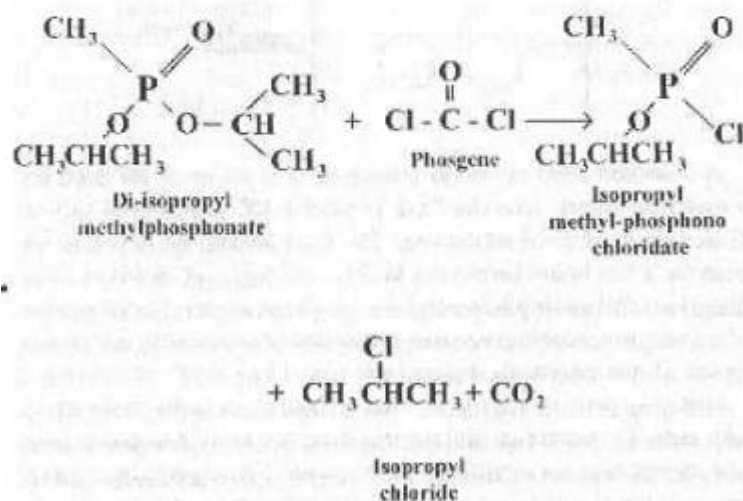

The bubbling of phosgene into the liquid is continued for 10 hours with stirring, then it is left to sit for some more hours, preferably overnight, or whenever the chemist is taking his sleep break.

When break time is over, a vacuum adapter is attached to one of the three necks, and the other two are stoppered. A vacuum is attached to the vacuum adapter, and a vacuum is slowly built up in the flask. An aspirator is best for producing the vacuum because it will flush the fumes down the drain. Stirring should be continued during the vacuum treatment. The vacuum will remove unreacted phosgene and the isopropyl chloride produced as a byproduct. Most of this unwanted material will be gone in about 10 minutes.

The vacuum line is then removed, and the reaction mixture is put in a 500 ml round-bottom flask, and the glassware set up for vacuum fractional distillation. A 10-inch-long Vigreux column works very well for vacuum distillations. An excellent substitute is to fill a claisen adapter about $\frac{3}{4}$ full with dime-sized pieces of broken glass. I have often used this for vacuum fractional distillations with fine results.

Distillation of the product is then commenced. I recommend a properly working aspirator as the source of vacuum. With a good, cold source of water to power it, a vacuum of from 10 to 20 mmHg should be attained. The small amount of forerun may be collected with a 50 ml round-bottom flask, then the product collected in a 250 ml round-bottom flask. The boiling point of the product at 2 mmHg is 38 to 40° C. And from 10 to 20 mmHg, its boiling point should be in the neighborhood of 55 to 60° C. The yield of clear liquid is nearly 250 ml.

A relevant cooking tip and commentary are called for at this point. In the aftermath of the 1994 and 1995 Japanese nerve-gas attacks, I spent in excess of twelve hours being interviewed by Japanese TV networks. During this time, I was able to pump them for information not available in this country. Analysis of the nerve-gas residue showed that a large fraction of their product was diisopropyl methylphosphonate. This demonstrates, first of all, that the amount of phosgene they used in this reaction was shamefully inadequate. It further indicates that this fruit-loop cult, made up of the "cream of Japanese society," didn't bother to distill the product

of the above reaction. If they had, they would have noticed that their reaction was incomplete at this step.

With the starting material made, Sarin can now be produced. Heavy-duty protective measures must now be taken by everyone involved in the synthesis of the final product. The starting material just produced, isopropyl methylphosphonochloridate, is not all that poisonous. It is only about as poisonous as strychnine. The product of the next reaction, Sarin, is not so harmless. All work must be done in the hood. Rubber protective clothing must be worn. A 5-gallon plastic pail filled with water to which a few cans of lye have been added must be handy. This pail is for putting glassware into after they have been used. The strong lye solution will destroy the Sarin once it has been in contact with it for a few hours. A 6-hour soaking will make the glassware safe for further cleaning.

Now for how the Sarin is produced. The glassware is set up as shown below:

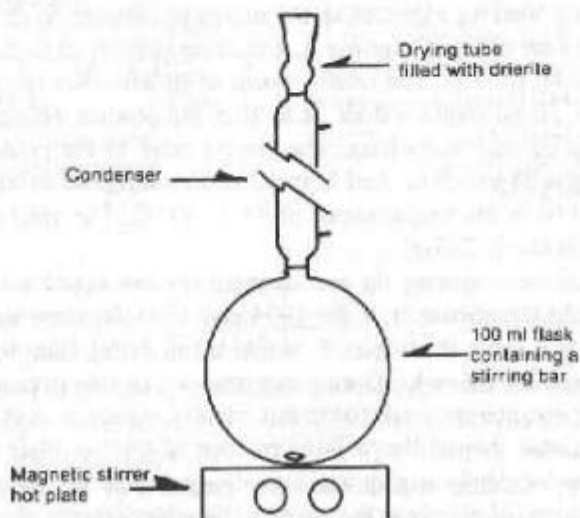

The glassware must be very dry to get the best results. Baking it in an oven for a few hours dries out glassware nicely. Into the 1000 ml round-bottom flask is put 250 grams of the isopropyl methylphosphonochloridate made according to the directions above, and 250 ml of methylene chloride and 110 grams of sodium fluoride (NaF). All ingredients should be of a high grade and free of moisture. The stirring is begun, and heat applied to the flask until the mixture boils. Since methylene chloride boils at about 40° C, the water flowing through the condenser will have to be very cold to condense it. The boil is maintained at reflux for 4 hours.

The following reaction occurs:

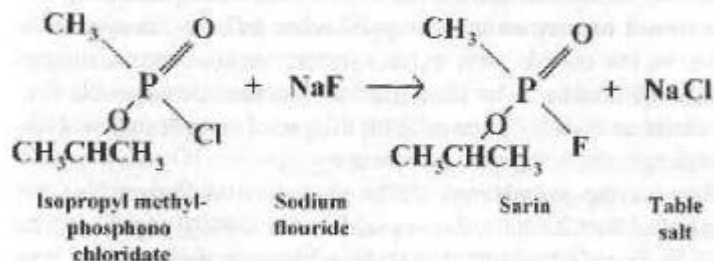

After refluxing for 4 hours, the mixture is allowed to cool, and the stirring stopped. A Büchner funnel is then assembled to a filtering flask, and the flask is connected to the vacuum line. The filter paper is securely placed into the funnel, and wetted with some methylene chloride to hold it in place. The vacuum is turned on, and the reaction mixture is filtered. The salt which was made in the reaction will filter out. It should be rinsed with some methylene chloride to get the last of the product, Sarin, off of it.

I must warn here that this filtering step, and the transfer to the distilling flask coming up, are the two most likely times for a spill accident to occur. Vigilance is the price of life!

The filtered product is transferred to a 1000 ml round-bottom flask, and the glassware set up for vacuum distillation. A few boiling chips (some pieces of pumice foot stone make a good substitute) should be in the flask. A Vigreux column or similar fractionating device should be attached.

A vacuum is applied, and the methylene chloride is removed under a vacuum. When most of it is gone, heat may be applied to the flask and the product collected in a 250 ml flask. Sarin boils at 56° C at 16 mmHg and 46° C at 8 mmHg. The yield is a little over 200 ml of Sarin.

All glassware goes into the lye soak after use, and the rubber clothing into a somewhat weaker lye bath. Work surfaces should also be drenched with the lye solution. The end of the vacuum line must also be soaked. The container that the Sarin is ultimately put into should be very securely stopped when full, and then sprayed down on the outside with a lye solution. A plastic plant mister works well for this. After rinsing off the solution after a few hours, the container should be coated with a layer of wax. It may now be considered safe, so long as it is not dropped.

VX

S-(2diisopropylaminoethyl)0-ethylmethylphosphonothiolate.

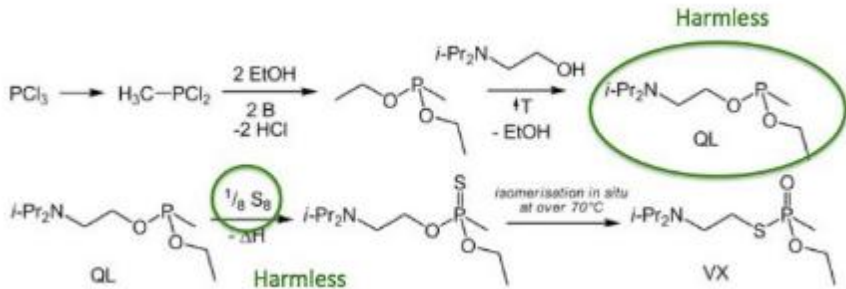

SOURCE - Chemical synthesis.

FORM - Heavy, oily liquid like motor oil; Odorless. Clear to straw in color. BP 300° C.

HANDLING - Avoid inhalation, ingestion, or skin contact. Handle only in a sealed glove box with decontamination apparatus. A good military mask and decontamination suit should be available.

DOSAGE - Skin - 10mg. Orally -2mg. Inhalation 10mg.min/cubic meter. VX has a very low vapor pressure and therefore is very slow to evaporate. The primary danger is from skin contact or ingestion, though it is very toxic as an aerosol.

SYMPTOMS - Dim vision, pinpoint pupils (may not occur from skin absorption), runny nose, tightness of chest, sweating, muscular twitching, nausea, vomiting, weakness and coma. Vapor inhalation or absorption of vapor through the eyes causes quickest onset of symptoms. Skin absorption generally takes about 10 minutes.

DETAILS - VX, like most other nerve gases, originated from insecticide research, which in this case, was done in Britain in the late 1950's. Unlike Sarin, VX is a persistent agent - meaning it can stay on target and active for weeks at a time (assuming proper weather conditions). This property also gives VX a much lower skin dosage than Sarin, as it will not evaporate before being absorbed. Mixing 50/50 VX and DMSO gives a liquid which absorbs through the skin in 2 to 3 minutes. DMSO both accelerates absorption and increases toxicity in organophosphorus compounds such as nerve gas. In the 1950's the Soviets experimented with a 50/50 mixture of DMSO and Soman (their standard nerve agent). They found the dose to be 1/6th as much as the pure agent.

Preparation of VX

1) 1000ml of hydrous ethyl ether and 234 grams of re-distilled dichloromethylphosphine are added to a 3 liter reaction flask which has been

previously flushed with dry nitrogen.

2) A mixture of 152.4ml (193.2g) of absolute ethanol and 583.1ml (627g) n, n-diethylaniline are placed in a dropping funnel and added dropwise with stirring to the mixture from step 1. During this addition maintain the reaction temperature at 20° to 30° C by use of an ice bath, and flush dry nitrogen through the system. The exit gas line from the condenser is connected to a mercury bubbler.

3) After the alcohol addition is completed, continue stirring for an additional 3 hours.

4) Remove the flask from the reaction apparatus and flush with nitrogen.

5) Pour the contents of the flask into a Buchner funnel and rinse the flask with 300 ml of anhydrous ethyl ether. Pour this into the funnel. Filter with vacuum from an aspirator equipped with a dry ice/acetone trap. Wash the filter cake with two 300ml portions of anhydrous ethyl ether. The filter cake is X, n-diethylaniline hydrochloride and is not used in this process. It may be saved and converted back to its original form for reuse.

6) The liquid reaction product is transferred to a 2 liter flask which has been previously flushed with dry nitrogen. Connect the flask to a 10 inch packed column with a stripping head and distill off the ethyl ether at a temperature of about 60° C. The exit gas line is sealed with a mercury bubbler to preclude the entrance of atmospheric oxygen into the system.

7) The remaining liquid is transferred to a 500ml flask and distilled in vacuum at 47°C/50mm. Yield is about 223.2 grams of di ethyl methyl phosphonite.

8) The 223.2grams of diethylmethylphosphonite is placed in a 1 literflask fitted with a thermometer and a condenser, and mixed with 119.6 grams of 2diisopropylaminoethanol.

9) Flush the flask with dry nitrogen and slowly heat from 23° to 110°c over the course of 55 minutes. Ethanol will begin distilling at 75° to 78.5° C. Continue a further 65 minutes to remove all ethanol. The temperature will reach 150°C at completion. Yield should be about 37.4 grams of ethanol.

10) Discontinue heating and flush dry nitrogen through the system while it cools to 50°C.

11) Fractionally distill under vacuum. The desired product, ethyl 2-diisopropylaminoethyl methylphosphonite, will distill at 54°C/100. Yield is about 136.8g. (Note - One of the original feed-stocks, diethylmethylphosphonite distills at 48°C/50mm. This fraction should be saved for reuse. Almost half (45%) may be recovered in this way.

12) Equip a 3 neck 1 liter flask with an agitator, a thermocouple well, an addition tube for the sulfur with a vibrating feed, and an addition line for nitrogen. The flask is immersed in a bath of ethylene glycol contained in a battery jar. Cooling is

controlled by lidding dry ice to the bath and heating, by a submerged electric heat coil.

13) Pour the 136.8 grams of ethyl 2-diisopropylaminoethylmethylphosphonite into the flask and start a nitrogen purge to maintain an inert atmosphere.

14) Use the vibrating feeder to slowly add 18.5 grams of ground rhombic sulfur. Allow 60 minutes to feed the sulfur. The reaction is kept at about 30°C with the dry ice/glycol bath.

15) 10 minutes after the last of the sulfur has been added, heat the flask as quickly as possible to 120°C, using the heating coil. and maintain at this temperature for 90 minutes. You now have about 155 grams of S-(2diisopropylaminoethyl)-O-ethyl methylphosphonite (VX) of 97.6% purity. Use it wisely.

NOTE - Do not attempt this process unless you are well versed and experienced in conducting reactions and distillations in inert atmospheres, and aware of the natures of the chemicals used. If you do not, you are courting disaster.

The base material for V gases is -

Triethyl Phosphite

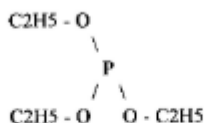

323 grams of triethyl phosphite is added to 284 grams (126 ml) of methyl iodide. These are refluxed together for three hours and purified with distillation according to the procedure described in Organic Synthesis Volume 31 or Collective Volume 4, page 325.

This produces Diethyl Methyl Phosphonate

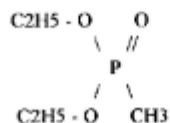

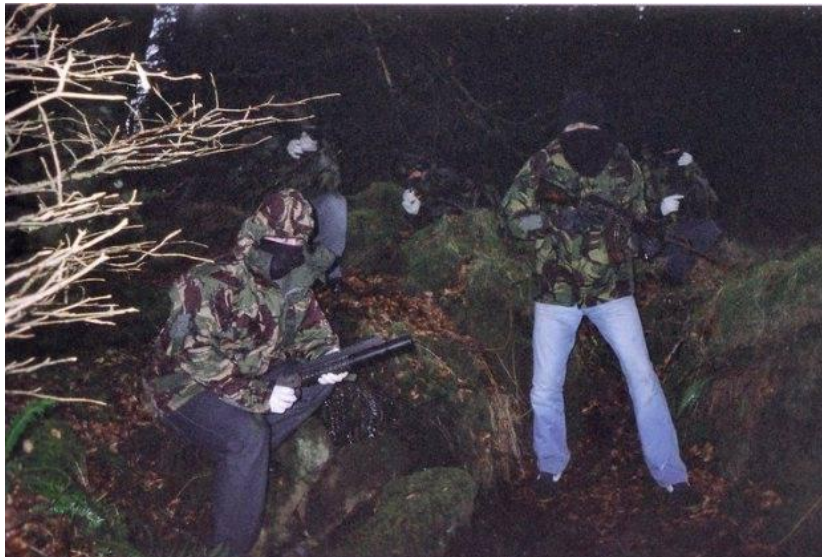

This material is then reacted with Phosgene (Carbonyl Chloride) which is bubbled through the phosphonate for 10 hours. The resulting oil is recovered by distilling.

This yields Methyl Ethoxy Phosphoryl Chloride

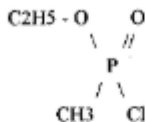

This is then reacted with the alcohol amine ethanethiol of choice.

In this example we will use 2-dimethylamino - ethanethiol which is first made by reacting N,N-dimethylethanolamine with SOCl₂ to yield the thiol and this is then reacted with alkaline hydrosulfite solution. [American Chemical Society Volume 66 Page 1921, and Volume 67 Page 1845.]

1. In a dry 2,000 ml round bottom flask, add 800 ml ethyl ether, 212 grams of methyl ethoxyphosphoryl chloride, 212 grams of dimethylaminoethanethiol, and 212 grams of triethylamine.
2. The contents are brought to boiling and heated with reflux for one hour.
3. The triethylamine is added so it reacts with the byproduct hydrogen chloride forming triethylamine hydrochloride crystals which are filtered off in a buchner funnel after cooling.
4. Ether and triethylamine is vacuum distilled off, then the main material oil is recovered by vacuum distilling at 80 C, at .06mm Hg.

A discussion of VX production, Sarin and attack methods

here is the most potent of all the V-gases. Its chemical name is methylethoxyphosphoryl thiocholine and has the following structure:

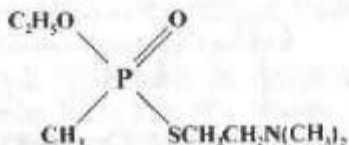

OR

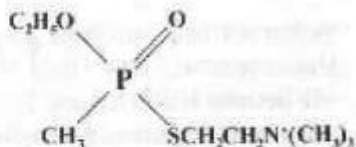

This compound is 10 times more potent than Sarin, and yet is not appreciably more difficult to make than Sarin. The advantages of the more potent product are obvious for the large-scale attack. The one-gallon size blast-dispersal bomb described earlier in this chapter, if filled with this V-gas, would then become the equivalent of a 10-gallon bomb. The lethal zone downwind of the drop sites would be considerably greater with the V-gas. The same size payload on the bomber plane would pack a much greater punch.

The two chemical structures shown above are both correct. The one on the left is the thiocholine nerve gas as it is produced in the main synthesis reaction. The one on the right is the quaternary ammonium compound derivative produced from it by reacting it with methyl iodide. The quaternary ammonium compound has the advantages of being more potent (it is believed that the positive charge on the nitrogen atom makes the poison more efficient at linking up with and deactivating the cholinesterase enzyme), and also more suitable for use as an assassination poison.

The quaternary derivative is more suited for assassination because the quaternary ammonium compounds are notoriously hard to detect in the body of the victim at autopsy. A V-gas

assassination is likely to remain a mystery, so long as it is done stealthily. Of course, if an anti-cholinesterase test is done on the blood of the mark, it will show that *something* has knocked out this enzyme system, but finding out what will be a task for a magician. This test would have to be done while the body is still fresh, or the enzyme system will go kaput anyway as a natural result of being dead and rotting.

The unquaternized product as it comes out of the reaction has the advantage of being a liquid (the quaternized material is a solid) so it is more easily dispersed into a fine mist of droplets from a blast-dispersal bomb, or an aerosol dispenser. A larger explosive charge would be necessary to do the job of shattering a solid mass of V-gas into a mist.

The unquaternized product has the disadvantage of not keeping as well as the quaternized product. It tends to rearrange into less-toxic substances when left standing. This process can be slowed down by freezing, but not stopped completely. In any case, it is very slow and not a matter for concern.

The V-gas, in both its unquaternized, and especially its quaternized form, has one great disadvantage in comparison to Sarin or Soman. It is not possible to vaporize the V-gas by heating it. This means that one possible means of attack by nerve agents is not going to work with the V-gas.

The attack plan to which I am referring here would be an option when a large group of the enemy is meeting in an auditorium, arena, coliseum or similar large structure that is under cover. In this example, the enemy could be attacked here with Sarin simply by heating a reasonable amount (a couple of pounds) of Sarin above its boiling point (nearly 200° C) in a location where the ventilation system would rapidly spread the gas throughout the building. A pandemonious scene reminiscent of spraying a room filled with flies would be the most immediate result. About half the Sarin would be lost to charring from heating it in this manner without the protection of a vacuum, but that is a trade-off likely to

be accepted by the attackers because of the simplicity of this means of attack.

A variation of this attack plan was used by that whacked-out Japanese cult in their first nerve-gas attack in the city of Matsumoto about six months prior to their subway escapade in Tokyo. The controlled US media blacked out news of this attack for fear of inspiring copycats, so let me fill you in on the details. In this trial run for the big show, some unseen operatives pulled into a parking lot a little upwind from an apartment complex. There they rapidly heated maybe a pint of their Sarin product, and let the fumes drift downwind into the apartments, where they killed about a dozen people and wounded 200. An interesting sidelight here was the behavior of Sarin when rapidly heated to boiling without benefit of a vacuum to protect it. White clouds were seen drifting on the winds into the apartments, these clouds no doubt being oxides of phosphorus formed from the breakdown of the Sarin due to heat. Also, vegetation in the vicinity was scorched, due to action of the phosphorus oxides, along with HCl and HF.

This reasonably effective, although hardly inconspicuous delivery method was abandoned in favor of a crackpot scheme for their subway attack. For this event, the aforementioned "cream of Japanese society" decided to dilute their Sarin with acetonitrile, put it in plastic bags hidden in luggage, and just poke the bag to puncture it and spill the solution onto the floor of the subway. To get the Sarin up into the air, they just relied upon passive evaporation, a very slow and ineffective process with a high-boiling-point substance such as Sarin. Even with the added surface area imparted by the dilution with acetonitrile, Sarin's vapor pressure is just too low at room temperature to cause much to evaporate into the air.

To attack a target such as the subway, these "geniuses of the Tokyo tunnels" would have been better advised to use an aerosol dispenser. Such a device could have simply enough been constructed and used by these aforementioned "geniuses." To begin

to consider this alternative, one must first look at and understand the common aerosol can found in all our homes.



Pictured above is a typical aerosol spray can. The can is filled with a solution of propellant and product. The purpose of the propellant is to create a good level of pressure inside the can to force the mixture up the stem and out the spray nozzle. There the propellant rapidly evaporates away, leaving a fine mist of the product drifting in the air. For nerve gas, one can use a very similar design. There are no real limits upon the possible size of the aerosol container. The preferred material for construction of this device is stainless steel, as fairly thin layers of steel can be eaten away by nerve gas, which could lead to the rupture of the vessel. The preferred propellant for nerve gas is Freon 12.

To construct such a device, one should start with the stem. It should reach nearly to the bottom of the container, and be welded flawlessly into a lid or filling portal for the container. Where the stem leaves the container, there should be two high-quality valves, such as from Swage-Lock, in series to hold back the product in the

can once it is filled. The stem should end in a spray nozzle such as those found at the hardware store for garden sprayers.

Next, we should consider filling the container. When filled, one would want about $\frac{2}{3}$ of its volume taken up with propellant-product solution, and one would also want the solution to be about 10% nerve gas and 90% propellant Freon 12. So, for a one-gallon container, add 250 ml of nerve gas. Cool down the container bottom with dry ice-acetone, and similarly chill a container of Freon 12. The boiling point of Freon 12 is -30° C, so it must be well below that temperature. Then, when it is sufficiently cold, drain the liquid Freon from its tanks into the aerosol container until it is about $\frac{2}{3}$ full. Then weld the top or filling portal with the spray stem onto the container. This completes construction of a nerve-gas aerosol can. It can be checked for leakage once it warms back to room temperature by using caged birds, etc. Finally, an automatic system which opens the valves on the stem is easily constructed. It would be most convenient to rig this automatic opening system with a timer, although radio control is also possible.

The synthesis of V-gas is very similar to the synthesis of Sarin. No special equipment is needed to produce it, just standard chemical glassware with ground-glass joints. One change from the synthesis of Sarin is that a good quality vacuum pump is required to produce a vacuum for the distillation of the final product. It has such a high boiling point that a vacuum less than 5 mmHg will have to be applied to distill it without burning the product.

The starting material for the production of V-gas is triethyl phosphite (for Sarin it was triisopropyl phosphite). This substance costs about \$15 per pound. An attacker may be wise to consider making this starting material, because the federal government tries to keep an eye on sales of materials which can be used for nerve gas manufacture. How well they do this, with all the attention they lavish on dope, is a matter for speculation. Whether triethyl phosphite is a remote enough precursor to evade their watchful eye, one can only guess. In any case, the main manufacturers would be bad places for an attacker to purchase this material because they

are all notorious government snitches to protect their federal contracts. The smaller local distributors may be less enamored of filling out forms for Uncle Sam. Very good directions for making triethyl phosphite can be found in *Organic Syntheses*, Volume 31, or Collective Volume 4, page 955.

As you can see by comparing this process to the Sarin production process, they are almost identical. Instead of triisopropyl phosphite as the starting material, we have triethyl phosphite. From there the process is the same until the final step where sodium fluoride is replaced with 2-dimethylaminoethanethiol.

Starting with triethyl phosphite:

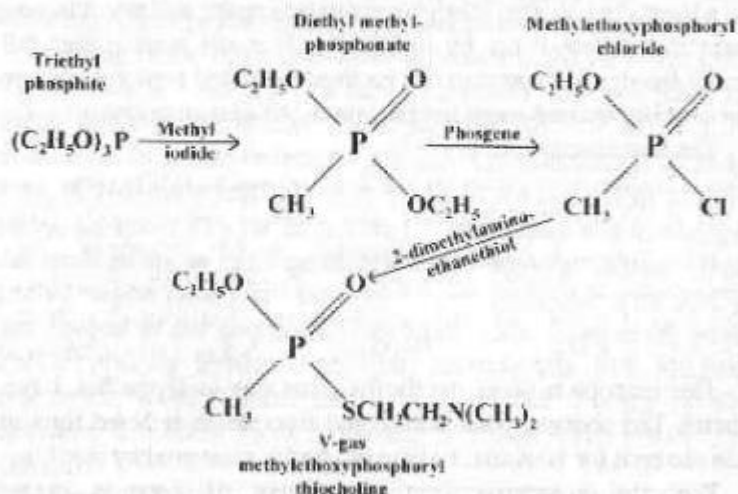

Directions for the first reaction can be found in *Organic Syntheses*, Volume 31 or Collective Volume 4, page 325. The title of the synthesis is Di-isopropyl methylphosphonate, which was the material used for the Sarin synthesis. At the end of the article, at the bottom of Note 2, is the modified direction for making diethyl methylphosphonate:

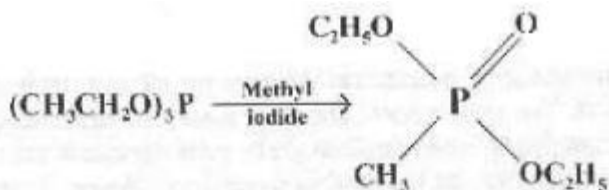

Equal molar amounts of methyl iodide and triethyl phosphite are reacted. For a convenient and productive 2-mole-size batch, that means that 332 grams of triethyl phosphite (348 ml) is added to 284 grams (126 ml) of methyl iodide. They are refluxed together for three hours, then the purification procedure given in the main text of the article is followed. The authors note that a small amount of a byproduct, diethyl ethylphosphonate is made, and that it is very hard to separate it out by distillation. It is my opinion that this small amount of byproduct can be lived with, and need not concern an attacker worried about the success of the next reactions.

The next reaction is:

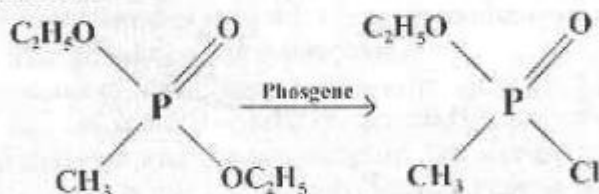

This reaction is done exactly the same way as in the Sarin synthesis. The phosgene (a.k.a. carbonyl chloride) is bubbled through the material for 10 hours, and the product is recovered by distilling.

With the preliminaries out of the way, the nerve-gas-crazed attackers are ready for the main production reaction:

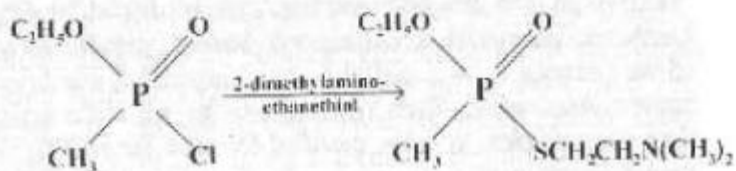

Naturally, the same safety precautions for the Sarin synthesis are needed for this reaction. Since an aspirator cannot produce the vacuum needed for the distillation of the product, it is doubly important that the fume hood used for this reaction have a good, steady draft of air moving through it. The vacuum pump must be in it, so that its exhausted vapors do not fill the room.

The interesting substance used instead of sodium fluoride, 2-dimethylamino ethanethiol, is another chemical that a careful attack group may consider making themselves rather than purchasing ready-made. I feel that this decision is wrong because the substance has legitimate use as a metal-complexing agent, and so with subterfuge could probably be obtained without arousing suspicion.

Weighing on the other side of the argument is the very high cost of this material. Aldrich is selling it for over \$50 per hundred grams, as the hydrochloride, with a purity of 90%. So to use it, it would have to be free-based and purified. The substance it is made from, N, N-dimethylethanolamine, is sold by the same folks at 99% purity, for about \$15 per kilo. This substance finds use in biology and medicine as an inhibitor of ethanolamine phosphokinase. This alcohol can be turned into the thiol by first reacting it with SOCl_2 (see *Journal of the American Chemical Society*, Volume 66, page 1921 (1944) by Breslow), and then reacting that with alkaline hydrosulfite solution under inert atmosphere (see *Journal of the American Chemical Society*, Volume 67, page 1845 (1945) by Gilman).

In any case, the main production reaction for V-gas is surprisingly easy. It is done as follows:

Into a clean, dry 2000 ml round-bottom flask, the following ingredients are added, quickly, one after the other with swirling to mix them: a few boiling chips, 800 ml anhydrous ethyl ether, 284 grams of the methyl ethoxyphosphoryl chloride, 212 grams of dimethylaminoethanethiol, and 212 grams (292 ml, cost about \$15 per kilo) of triethylamine. It is crucial here that the glassware be very dry, and that the ingredients, especially the chloride, be protected from moisture, because the presence of water really

lowers the yield in this reaction. I recommend baking the glassware in an oven, and allowing it to dry in a dessicator.

When the ingredients have been added and mixed, a good, efficient condenser topped with a drying tube is attached to the flask, and a flow of good, cold water is put through the condenser. The contents of the flask are heated to boiling with a hot-water bath, and a reflux is maintained for one hour.

The byproduct of this reaction, hydrogen chloride, is absorbed by the triethylamine as it is produced, forming triethylamine hydrochloride crystals. This acid absorption is the reason for having the triethylamine in the reaction mixture. Without it, the hydrogen chloride evolved would interfere with the reaction.

At the end of the one-hour heating period, the mixture is cooled, and the crystals of triethylamine hydrochloride are filtered out in a Buchner funnel. The crystals may be rinsed with ether to get the last of the product off them.

The filtered reaction mixture is then returned to a 2000 ml round-bottom flask, a few boiling chips added, the glassware set up for simple distillation, and the ether removed by distilling it off under a gentle vacuum. An aspirator is perfect for this job, since it will flush the ether fumes down the drain.

When most of the ether is gone, the mixture is poured into a 1000 ml round-bottom flask with a few boiling chips. The remnants in the 2000 ml flask can be rinsed out with some ether and poured into the 1000 ml flask. Once again this flask is set up for simple distillation, and full aspirator vacuum is applied to it. The last of the ether and triethylamine (bp 88° C) will be gone shortly.

Now the vacuum from the good-quality vacuum pump is applied to the distillation. A vacuum of less than 1 mmHg is to be preferred here to keep the distillation temperatures reasonable and to avoid burning the product. A McLeod gauge should be used to keep track of what kind of vacuum the pump is pulling (cost about \$200).

After a small forerun is collected in a 250 ml flask, a 500 ml flask is attached, and the main bulk of the product is collected at a boiling point of 80° C at a vacuum of .06 mmHg. This boiling

point rapidly increases with increasing pressure. The yield is 260 to 275 ml of product. A fair amount of tar remains in the distilling flask.

This product may be poured into a large glass bottle for storage, as with Sarin. The 40 oz. beer bottle is ideal for bomb design, and once it is coated with wax, it is fairly safe, if not dropped.

If the aim of the attacker is a single assassination, quaternization is called for. To do this, a couple drops of V-gas are put into a test tube $\frac{1}{4}$ filled with ether. Twice the number of drops of methyl iodide as V-gas is then added, along with a boiling chip. The mixture is heated to boiling for a few hours, then allowed to slowly cool down. The ether and unreacted methyl iodide are removed under a vacuum, the crystals washed with a little more ether, and the resulting product is ready for use.



What about other chemical weapons?

VX and Sarin are the most potent chemical weapons available, but if you require something more simple then look no further than Uncle Fester's Silent Death book, Scientific Principles of Improvised Warfare and Home Defense Volume 5 Chemical Weapons, Handbook of Chemical and Biological Warfare Agents by D. Hank Ellison and Assorted Nasties by David Harber. David Harber's book is recommended due to the simple preparation guides.

Hydrogen cyanide gas grenade

POTASSIUM CYANIDE

Potassium cyanide is a potent cellular poison that can be used as is or in the manufacture of hydrogen cyanide gas or poison-tipped bullets. As a rule, always wear appropriate protective gear when making and handling cyanide products.

MATERIALS

Potassium carbonate

Potassium ferrocyanide

Crucible

Furnace

Tongs or long-handled
pliers

Iron pan, etc.

Hypo solution

Sodium nitrate

Hypodermic needle

lar

SOURCES

Chemical supply store

Chemical supply store

Chemical supply store

Sec. I, No. 49

Photography store

Chemical supply store (Sec.
I, No. 18 is *not* acceptable)



PROCEDURE

1. Ignite the furnace as outlined in Sec. I, No. 49.
2. Place 8 parts by weight of potassium ferrocyanide in the crucible for 5 minutes without the air supply.

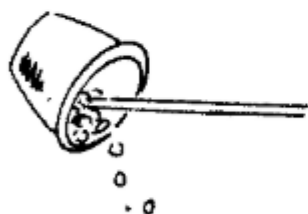

3. Remove the crucible from the furnace and scrape out the ferrocyanide.



4. Repeat steps 2 and 3 with 3 parts by weight potassium carbonate. Mix the ferrocyanide with the carbonate.

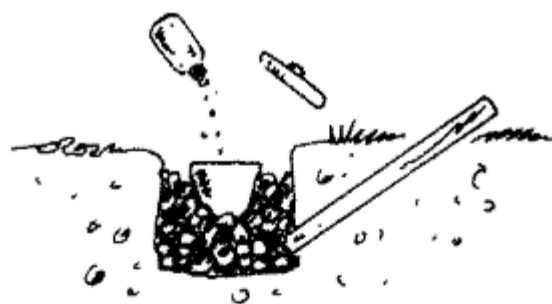

5. Put the crucible in the furnace, put the cover on, and start up the air supply. After about 10 minutes, remove the cover with tongs and add the ferrocyanide/carbonate mixture. Soon the powders will melt and then start to boil.

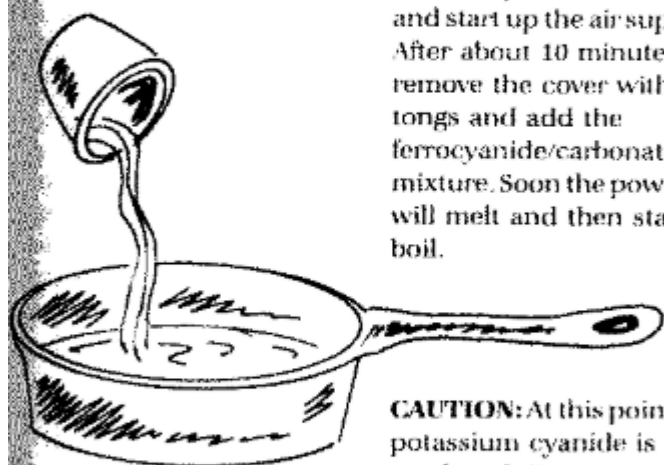

6. As soon as the bubbling stops after the gases have been driven off, remove the crucible from the furnace with tongs and pour the clear liquid only onto the cool iron pan.

CAUTION: At this point the potassium cyanide is produced. Be very careful when handling the materials that come in contact with the cyanide. If any come in contact with skin, immediately wash it away with lots of water.

7. Pulverize the white mass that crystallizes on the pan and place in a jar for storage.



Note: In order to make tablets of potassium cyanide, add just enough Elmer's glue to the desired amount of powder to moisten it. Next, press it into a mold, such as a ring of $\frac{7}{8}$ -inch copper tubing, and let the glue dry.

ANTIDOTE FOR CYANIDE POISONING

In case of cyanide poisoning, give the victim an injection of 10 milliliters 25-percent hypo (sodium thiosulfate) solution and 10 milliliters water in which 1 teaspoon sodium nitrite has been dissolved. If possible, get victim medical attention as soon as possible.



HYDROGEN-CYANIDE GRENADE

The hydrogen-cyanide grenade is a reliable way to generate a cloud of extremely poisonous hydrogen-cyanide gas. A small amount of this gas can incapacitate or kill anyone breathing it. Hydrogen-cyanide grenades are most effective when used in an enclosed area; there the gas cloud will dissipate slowly and remain effective for a longer time.

MATERIALS

SOURCES

Potassium cyanide	Chemical supply store or Sec. VIII, No. 2
Sulfuric acid (90-percent concentrated)	Sec. I, No. 43
Sodium chlorate	Chemical supply store or Sec. I, No. 23
Sugar	
Paper, uncoated	
External burning fuze	Sec. VI, No. 7 Firecracker fuze
1/4-inch copper or aluminum tubing	Hardware store
Primary explosive	Mekap, acetone peroxide, or HMTD
Epoxy resin	Hardware store

MATERIALS

Screwdriver or awl

Tin can with lid

Test tubes with stoppers

Adhesive tape

Wooden dowel

Water

Heat source

Pot or pan

SOURCES

Chemical supply store

PROCEDURE

1. Cut off a 2-inch section of the $\frac{1}{4}$ -inch tubing. Seal one end with epoxy resin and let dry.

2. Fill the 2-inch section of tubing with primary explosive and carefully pack it with a wooden dowel. Place 4- or 5-inch fuze in the open end and seal with epoxy.

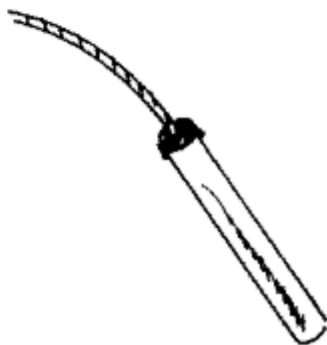
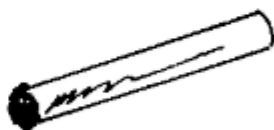

3. Remove the lid of the can. Using a pen or pencil, trace the outline of the lid on a piece of blank paper and cut out.

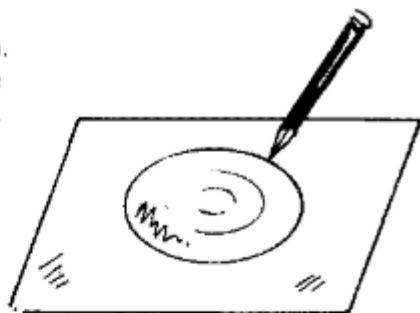

4. Dissolve 3 parts sodium chlorate and 2 parts sugar into some hot water. When dissolved, put the paper cut-out into the solution and gently stir for 5 minutes. Remove it from solution and let dry.



5. Using the screwdriver or awl, punch many small holes in the can lid. Make sure to punch a hole in the center big enough to fit the fuze. Do not bend or damage the outer edge of the lid.

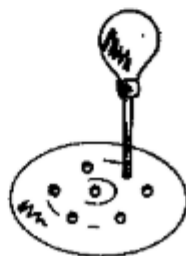



6. Fill 3 or 4 test tubes with sulfuric acid. Place the stoppers in firmly and clean off all excess acid. Epoxy the test tubes to the inside of the can.

7. Fill the bottom of the can with a ½- to 1-inch layer of potassium cyanide.

CAUTION: Potassium cyanide is extremely poisonous. Always wear gloves when handling it. Refer to the information on Potassium-cyanide safety in Section VIII, No. 2.

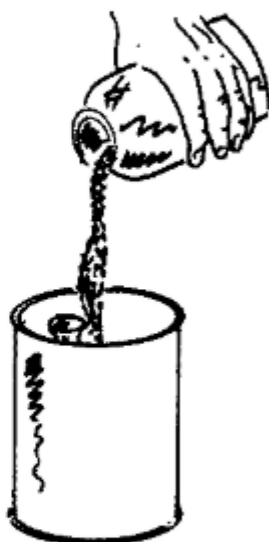

8. Place the fuze through the center hole in the lid so that the detonator is on the lid's underside. Tape the detonator in place.

9. Punch a hole through the center of the sodium-chlorate/sugar paper. Slide it over the fuze so it rests flat against the lid, covering the holes. Tape it securely in place.

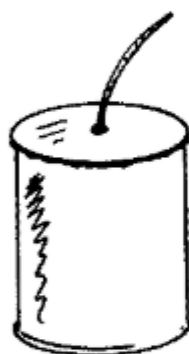
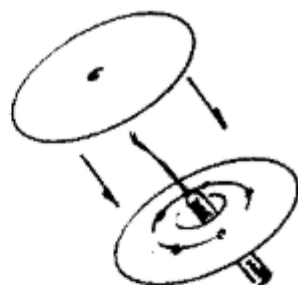

10. Epoxy the lid to the can, leaving no spaces for the potassium cyanide to escape from. Let the epoxy dry. The grenade is now ready for use.

HOW TO USE

Positioned upwind from the exploding grenade, light the fuze and throw towards the target area. When the fuze burns down to the paper disk, it will ignite and burn away, leaving the holes exposed. The detonator will then explode, breaking the test tubes open and mixing the acid and potassium cyanide. Hydrogen cyanide will be produced and will escape through the holes. These grenades are best used as defensive weapons to block entrances and exits or cover a retreat.

XV. Firearms Manufacturing

In the following pages a few essential chapters from Home Workshop Prototype Firearms How To Design, Build, And Sell Your Own Small Arms by Bill Holmes (1994, Paladin Press) are reproduced. Following these introductory chapters, practical construction guides for key weapons will be detailed. Make sure to read the build guides after Bill Holmes' chapters, as Bill Holmes' guide is for advanced operations and should be considered in an ideal scenario.

Chapter

Tools and Equipment

2

While it is possible (although time consuming) to build a firearm in its entirety with a few files, a hand hacksaw, and a hand drill, decent power tools will not only cut down the construction time but probably also improve the quality of the finished work considerably. Let's take a look at some of the equipment that would be required for an operation of this kind.

Probably the most important item is an engine lathe. With suitable accessories and tooling, such a machine can perform all sorts of operations, including turning, threading, boring, and knurling. With a milling attachment, it can in many instances substitute for a milling machine, take the place of a drill press, and when properly equipped, even put rifling in barrels.

When contemplating the purchase of a lathe for the first time, far too many people actually go out of their way to seek out the smallest machine they can find, not only to save money but with the mistaken idea that the smaller machines are actually more precise when making small parts.

In fact, I read an article sometime back by a self-proclaimed lathe expert in which he stated that a small 6- to 9-inch lathe was best for making most gun parts. He claimed that a larger lathe of 14 to 16 inches would be clumsy to operate, and that the operator would probably break such small parts as firing pins when attempting to turn them on the larger machine.

As far as this writer is concerned, the truth of the matter is that a modern geared head lathe with a 14- or 15-inch swing and 40 inches or more between centers is the only way to go. Such a machine usually weighs a ton or more and, when properly set up on a rigid surface and leveled, will provide a solid, vibration-free platform for turning operations. The geared head machine, in addition to its ease in changing speeds compared to a belt-driven headstock, will also allow heavier cuts to be taken with less tendency to chatter than the belt-drive machine is capable of.

The machine should be level, both lengthwise and crosswise, and preferably bolted to the floor.

A 17-inch lathe, as shown here, is sturdy, accurate, and vibration-free. A 13-inch lathe is adequate and less expensive.



This welding machine will do MIG, TIG, and stick welding.



Many novices neglect to do this, and not only does accuracy suffer, but the machine may wear rapidly due to misalignment.

Most machines of this size will come equipped with three-phase motors. Unless three-phase power is available at your installation, you will require some sort of converter to allow running the motors on single-phase current. These are available through machine tool supply houses, ranging from small boxes for use with one motor to the large Rotophase types, which,

when properly wired into the circuit, will start and run a whole shop full of motors. These are also expensive.

Both a three-jaw and a four-jaw chuck should be acquired with the lathe if possible. If only one chuck can be afforded, it should be the four jaw since irregular shapes as well as round can be centered precisely through individual movement of the four jaws, whereas the three jaws open and close simultaneously and will only accommodate round stock.



A milling machine is almost mandatory if much work is anticipated.



Precise drilling operations can be simplified by using the mill as a drill press.

A set of collets and a collet closer would be nice to have, as well as a quick-change tool post, a live center for the tailstock, a drill chuck, a steady rest, a follower rest, and also, if possible, an adjustable automatic carriage stop.

To better understand why I suggest such extras as an automatic carriage stop, perhaps it would be worthwhile to describe my own shop and its operation.

My shop is a one-man shop. At present I am engaged in building a trap gun of my own

design. By working long hours and running several machines at the same time, I can usually build three of these guns per month. I know, I could hire some help and probably up production. But I have tried it several times in the past, and after a while the employees decided that they knew more than I did and didn't need to do what I told them. I don't like to argue, so I work by myself. If it isn't right, there is only me to blame.

I have two engine lathes: a 15-inch Colchester

A metal-cutting saw is useful.

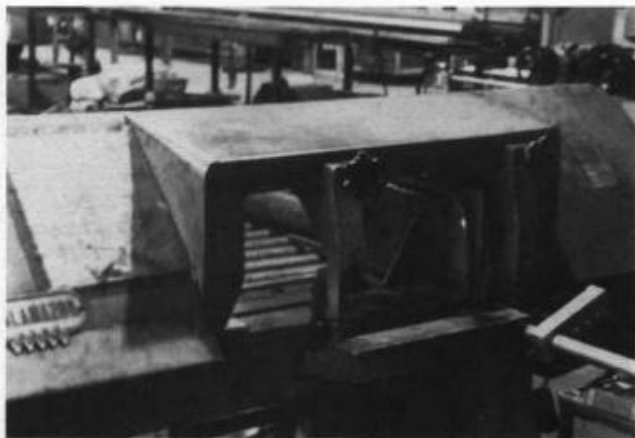

A "cold saw" is faster than a continuous-blade type.

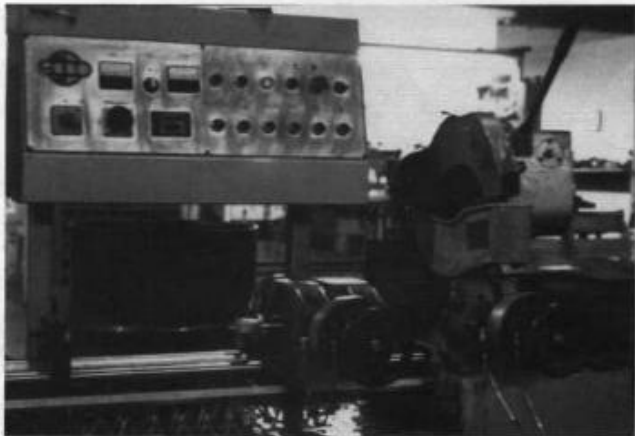

and, parallel to it but facing the opposite direction with a 4-foot walkway in between, a 14-inch Taiwan-made lathe. At one end of the walkway stands an Induma vertical milling machine, while at the other end is a Bridgeport vertical mill. Each has a power feed on the table. Arranged in close proximity as they are, it is possible to run at least two and much of the time all four of these machines at the same time simply by setting up a cut and engaging the power feed of each. Since the automatic carriage stop

will disengage the power feed when it reaches the end of the cut, I can simply go from one machine to the next, setting up a new cut and restarting the power feed.

Located just a short distance away from these four machines, I have a small turret lathe, a combination MIG, TIG, and stick-welding machine, as well as an oxy/acetylene welding and cutting outfit. I have a horizontal metal-cutting band saw with an automatic shut off (which means I don't have to stand over it to shut it off when it



If no milling machine is available, slots and openings can be cut with a hand grinder using cut-off wheels.

finishes a cut), a wood-cutting band saw, and a large vertical metal-cutting band saw. This last machine is even more versatile because it has a built-in blade welder and grinder. This enables me to buy blade material in 100-foot rolls and make up blades for all three saws at a fraction of the cost of ready-made blades.

I also have a surface grinder, a small electric heat-treat furnace, a pedestal grinder, and a couple of bench grinders. Some polishing equipment coupled with a bluing setup and the usual files and hand tools pretty well round out the shop, giving me the capacity to make up about anything I might want in the firearms line. Now if I only had the skills and ability to go with the tools and machines . . .

You probably noticed that I did not mention owning a drill press. This is because I do not have a drill press as such. By mounting a drill chuck in the milling machine, I not only have a solid, sturdy drill press, but I can locate holes exactly where I want them without any guesswork.

The most versatile milling machine for our purpose is a full-size Bridgeport-type machine with at least a 42-inch table. If you anticipate installing ribs on shotgun barrels or machining rifle barrels to a cross section other than round, then a 48- or 49-inch table machine should be procured. Although most gun setups require only a mill vise and no more than four collets—

specifically 1/4, 3/8, 1/2, and 3/4 inches—to take care of 90 percent of any work you may contemplate, it is desirable to have a full set of collets from 1/8 to 3/4 inch by sixteenths. A drill chuck is a required item. Also useful at times are a rotary table, a dividing head, and a boring head. As previously mentioned, a power feed on the machine will allow it to run while you perform other work and is almost like having an extra man in the shop, except you won't have to argue with him.

As with the lathe, the milling machine should be level both lengthwise and crosswise and bolted to the floor. Close attention should be paid to making sure the vise jaws are parallel to the table. Otherwise the machine will not make parallel cuts. I could have bought a little Clausing milling machine at just about my own price not long ago from a fellow who thought it was worn out. I aligned the vise with the table (it was cocked about 2 degrees), leveled the machine, and bolted it down for him. After we ran it for a little while, he took it off the market. He said it was like having a new machine and was no longer for sale.

Many experienced machinists neglect bolting the machines down. Some even snicker when it is suggested. While it is true that the weight of the machine usually will make it fairly solid, bolting it down will dampen and absorb vibration. This, to me at least, makes it worthwhile.

The welding equipment that you should own depends on what types of welding you are proficient at or willing to become proficient at. I say willing to become proficient because to become good at it you must practice, practice, and practice some more. This is the only way to become a first-class welder. You can learn how from books or schools, but experience is the only way to develop proficiency. If you are capable of using them, there are combination machines available that will do TIG (this stands for Tungsten Inert Gas) welding, which is often referred to as heli arc welding, MIG welding (this is a wire-feed process), as well as stick welding, which will take care of about any welding jobs you need to do.

Lacking the skill to use the welding equipment, the best alternative is to find a full-time welder who understands guns and will realize that beads must be built up above the surface to permit machining flush, and what effect polishing and bluing will have on it. The average heavy equipment welder who spends his time

welding on bulldozers, dump trucks, and the like will usually ruin the kind of work you need him to do and should generally be avoided.

In any event, the shop should have an oxy/acetylene outfit to be used for silver soldering, brazing, welding, and cutting, and to apply heat for certain bending and forging operations. It can also be used to harden and temper certain types of steel when no furnace is available.

You will also need a grinder of some sort. A good vise is essential, as is a metal-cutting band saw. Such saws are available for both horizontal and vertical use. Use it horizontally to cut material to length. Vertically it can be used to saw parts such as hammers, triggers, and sears almost to shape, after which they can be finished by milling, grinding, or filing.

Several files of assorted shapes and sizes should be on hand, together with a few metal-cutting chisels, some punches, a scriber or two, and a square and level. Other items can be acquired as needed.



Chapter

Materials

3

Quality firearms should be made of wood and steel. At times it is acceptable to use aluminum as a weight-saving measure. Shotgun muzzle brake bodies are an example of this. But, what I refer to as "pot metal" such as zinc, zamak, pewter, and the like should be avoided.

Quality sporting firearms will have stocks made from high-quality hardwood such as walnut, maple, or myrtle. Beech, gum, sycamore, and the like are used on cheaper guns and are, at most, second best.

There has been a trend over the past several years to try and brainwash the shooting public as to the superiority of synthetic stocks for use on hunting rifles and shotguns. This is mostly a pipe dream that the manufacturers have conned the gun writers into believing and passing on.

While it may be true that in some instances these are more stable and less apt to warp than their wood counterparts (try leaving one out in the hot sun all day), and they are supposedly less prone to cracking and breaking (try drop-

ping one on a hard surface in cold weather), the real advantage is the cost saving due to cheaper materials and less labor.

I have used synthetic stocks and forends myself in the fabrication of military-type weapons and, at one time, in an economy-grade trap gun that I intended to market. This was done, in the case of the military weapons, primarily to save weight, but also because I could obtain surplus M16 stocks at extremely low prices (from \$2 to \$8 dollars each) and easily adapt them to fit my guns. In the case of the trap gun, I molded the grip, used modified M16 buttstocks, and turned the forend from black nylon. The time saved in finishing and elimination of checkering, plus cheaper materials (I used wood costing \$200 in the deluxe-grade gun, as opposed to \$15 worth of materials in the economy grade), was passed on to the customer in the lower-priced gun.

There are all sorts of cheaper grades of steel that could be used to fabricate the metal parts, that is, if we only intended to fire a few rounds

through the gun. But what we are seeking here are materials to make our parts that will last for several thousand rounds and more. Therefore, we must seek out and set in place the best materials available for this purpose. While there are people who would question my choices, as far as I am concerned, chrome molybdenum steels such as 4130, 4140, and 4150 are suitable to build the entire gun. Known as Chrome moly, Brake die, Maxell and other nicknames, these steels are easily heat treated, machine cleanly, and possess high tensile strength and elasticity. Furthermore they can be welded without ruining them, as sometimes occurs with other steels.

Nickel steels of the 2330-2340 variety are also entirely usable, as are the nickel chromium steels designated 3130, 3135, or 3140.

The numbers associated with these steels, in case anyone is wondering, are partial descriptions of their compositions. The first figure describes the class to which the steel belongs. The second figure indicates the percentage of the main alloying element. The last two figures indicate the carbon content in hundredths of one percent or "points." Therefore, 3140, as an example, describes a nickel steel with approximately 1 percent nickel content and a carbon content of forty hundredths of one percent, sometimes referred to as 40 points of carbon.

4130 seamless tubing is ideal for shotgun barrels, tubular receivers, and the like. It is usually available from metal supply houses in so many inside diameters and wall thicknesses that at least one will be close enough to adapt to your use.

Round stock is available in the desired compositions and in almost any diameter needed from these same metal supply houses. Flat stock for hammers, sears, triggers, etc., is also available from the same sources in almost any fractional thickness desired.

In many cases, these materials must be purchased in rather large quantities. If the vendor can be persuaded to cut off the small quantity desired, they will charge you an exorbitant price for it. Many metal supply companies will try to charge \$15 to \$25 just to saw a piece of metal in two.

Therefore, when only one gun is to be built, look for some other source of materials. Automobile and truck axles contain material suitable for bolts, barrel extensions, gas cylinders, and whatever other round parts are need-

ed. Actually, if sawed into strips, flat parts can also be made. Axles can usually be obtained from salvage yards for \$2 to \$5 dollars each. Leaf springs, as used on the rear axles of older cars and pickup trucks as well as on larger trucks, are a source of flat stock. Hydraulic cylinders and discarded shock absorbers contain smaller-diameter shafts useful as round stock and tubing. This tubing will seldom, if ever, be adaptable to shotgun barrel use, but in certain instances it can be used for receivers. Motorcycle front forks will yield just about the same sizes and types of tubing and round stock as the hydraulic cylinders, as will large-diameter aluminum tubing, which can sometimes be used to make shotgun muzzle brake bodies.

Some of the material suggested, especially the axles and leaf springs, will be too hard to machine easily. They will require softening, or annealing. This is accomplished by heating the metal slightly above its critical point and allowing it to cool slowly. Since the average heat-treat furnace is too small to fit the axles or spring leaves, another method must be found.

Fire departments usually take a dim view of uncontained open fires within city limits, so you will likely have to go to the country to do this. Accumulate and pile up enough wood to make a fire that will completely surround the metal objects and burn for three or four hours. Place the metal objects on top of your wood pile and start it on fire. If you have enough wood, it will heat the metal to the required temperature. As the fire burns down, the metal parts will sink into the ashes, where they cool very slowly. They are usually left overnight; when removed the next morning, they will probably still be warm. They will also be softened to a point where they will machine easily.

The axles described are usually made from material with a high enough carbon content to permit heat treatment to any hardness desired. Many of these are made from the same 4140 recommended in the first place. They are also found made from 4150, 4340, 2340, 3140, and other alloys.

Leaf springs are mostly made from material with a high carbon content. Compositions commonly found in these are 1085, 1095, 4063, and 4067.

It should also be mentioned that the stems of

automobile engine valves are suitable for firing pins. They, too, must be annealed before they will machine freely.

After the component parts are cut to shape, fitted, and finished, they should be heat treated as detailed in Chapter 20. Properly done, parts made and heat treated as described will last a lifetime.

For those who think a gun should be made from stainless steel (I am not one of these), it should be noted here that seamless tubing of the same dimensions deemed proper for the shotgun barrels described is available with a cold-drawn finish in 416 stainless according to the company I buy from. Round and flat stock is available from the same source. If you must have stainless, an alloy called 416F, which is a nickel-bearing chromium steel with enough sulphur added to make it machine freely, is probably the best choice available.

There are any number of companies and individuals advertising gunstock wood in several of the gun magazines. If you will be satisfied with black walnut, a local lumber yard usually will have at least a small supply on hand. This is true in the eastern and midwestern states. In California and other far western states, one can also find a goodly supply of so called "English" and "Claro" walnut. It is advantageous to be able to examine wood before you buy it.

Most large cities have at least one plastic supply house that carries, or can get, black nylon or other synthetic material to use in forends. Fiberglass and epoxy can be found at auto parts houses. They sell it to body shops for use in auto body repair. Boat builders and repair shops also keep a supply on hand. If M16 buttstocks are required, several surplus gun parts suppliers advertise them for sale.



Chapter

Helpful Hints

6

The purpose of this chapter is to pass on any bit of information that I can think of which might be helpful to you. Some of it might have been included in other chapters. Other parts of it probably have no relevance whatsoever. But again, some of it might come in handy.

When drilling holes, if they are expected to be round and straight, sharp drills must be used. The material to be drilled should be clamped or held in a vise and secured to the mill or drill table. If you try to hold it in one hand and feed the drill into it with the other, as many people try to do, torque caused by resistance to the drill tries to turn the material in the opposite direction, causing the drill to crawl off center. This is the cause of most crooked or oversize holes.

Holes should be started, especially on round-ed surfaces, with a center drill, drilled to depth with an undersize drill, and finished with a drill of the proper size. When holes are to be tapped partway through, the hole is first drilled with the tap drill, the full-size portion drilled for

clearance, and the hole tapped, in that order. When drilling for pivot pins, such as for a trigger or hammer, the frame or housing that the pivoting part fits into should be drilled from the side that the pin is installed from with a drill of the same size as the pin. The opposite side is drilled with a slightly smaller drill to grip the pin and hold it in place, and the hole through the pivoting part slightly larger so that it will pivot without binding.

Contrary to popular opinion, a .125-inch pin will not rotate freely in a .125-inch hole. Assuming that we are using a 1/8-inch pivot pin, we drill the hole completely through all surfaces with a No. 31 drill, which measures .120 inch, or .005 undersize. The one side is drilled to 1/8 inch, or .125 inch. The hole through the pivoting part is drilled with a 3.20 millimeter drill, which has a diameter of .126 inch. This will allow the part to pivot on the pin without resistance and still not wobble. Holes for other sized pins are done in the same manner.

Straight holes can be drilled fairly close to

their required location with a hand drill, provided that the work is clamped or otherwise secured to prevent its movement. Both hands should be used to hold the drill in an absolutely vertical position, or at 90 degrees to the work. Holes should be started with a center drill and drilled to depth with an undersize drill, followed by the drill of the correct size.

If absolute precision of hole location is essential, the milling machine should be used in the same manner as a drill press, with the work fastened securely to the table and moved into exact location with the table feeds. Even now, the center drill should be used first, followed by drills as described above.

Bolt lugs, raceways, holes spaced around the diameter, etc. are located and spaced through use of a rotary table, dividing head, or spacer. In the event none of these are available when needed, fair success can be had in locating equally spaced positions around the outside diameter by wrapping a strip of masking tape around the work and marking the exact length of one turn. The tape is removed, laid out flat, and measured. This measurement is divided by the number of positions required and each of these marked on the tape. The tape is then wrapped around the circumference of the work once more. Each of these marks now represents a center line for the rows of holes used in the shotgun muzzle brakes, or center lines for bolt lugs, or whatever. Inside divisions can be made by wrapping the tape around a shaft that fits the inside diameter closely and dividing as above. It is then inserted into the work and location marks transferred from the tape to the end of the work. This method is not intended to replace precision equipment, but if only a few such operations are to be undertaken and the equipment is not available, this method will pinpoint locations to within a very few thousandths, if care is taken.

Grinding wheels are usually too slow to shape metal parts. The sanding discs used primarily in automobile body shops are available from hardware and auto parts stores. These are fairly stiff, fiber-backed discs usually of 7- or 9-inch diameter. They are available in grits ranging from 24 to 120. A backplate just slightly smaller than the discs is made from plastic, masonite, etc. and mounted behind the disc on

an arbor. Parts can be shaped to almost exact contours using this method. These are also useful when shaping wood.

Inside polishing, such as inside trigger guards and the like, is made easier by sawing a lengthwise slot in a wood dowel. Strips of abrasive cloth or paper are mounted by placing one end in the slot and winding several turns around it in the opposite direction of its rotation. A 1/2-inch drill chuck that can be mounted on a motor arbor and the dowel chucked in it is ideal for this. Use a fairly high-speed motor of 3750 RPM or similar for this.

Recoil pads mounted on the straight-line recoil type buttstocks have upper mounting screws that come out right in the place where the stock bolt hole is located. Sometimes another screw can be located higher and miss the bolt hole. It is easier to silver-solder a screw head to the end of the stock bolt that will accept an Allen wrench. The recoil pad's upper screw hole is enlarged to permit insertion of the Allen wrench and a corresponding slot cut in the face of the pad. The pad is then mounted in place using epoxy cement and the lower screw. The stock bolt is turned by inserting a long, round-bodied Allen wrench through the face of the recoil pad. If a coating of oil or grease is used to lubricate the Allen wrench, the face of the recoil pad will show little or no evidence of the wrench insertion after it is withdrawn.

Marks and scribed lines on metal are often hard to see during the sawing or milling process. A thin coat of layout fluid such as Dykem brushed on and allowed to dry for a few minutes will make subsequent lines more visible. This product is available from both machine tool and gunsmith supply houses in red, blue, or other colors. Obtain a can of remover and thinner at the same time. An even better method consists of polishing the surface of the metal bright and swabbing on a solution of copper sulfate. This will leave a thin layer of copper deposited on the surface that causes any markings to stand out vividly. Copper sulfate is a blue crystalline powder available from drug stores. It is also known as Bluestone and Blue Vitroil. The solution is made by adding all the copper sulfate that four ounces of distilled water will dissolve. Add 12 to 15 drops of sulphuric acid to this.

Years ago, a cold bluing solution that came in two bottles was marketed. The contents of the first bottle (copper sulfate) was swabbed on the clean bright steel, which imparted a thin copper layer. The contents of the second bottle, which consisted mostly of arsenic trioxide, was applied next, which turned the copper black. As I remember, it resulted in a better black color than the modern cold blues. But, like most of the others, it started to rub off in a short time. It was also one of the foulest smelling concoctions I ever came in contact with.

In many instances, silver solder will be used to mount sight bases, trigger guards, barrel bands, and various other parts. There are people who will tell you that the correct way to join parts using this material is to cut strips of the flat "ribbon" material and sandwich it between the parts to be joined, whereupon heat is applied, the solder melts, and, when cool, the joint is made. This may work for some people. Everytime I tried it, however, the results were somewhat different. When the work is clamped together and the sandwiched silver solder melted, the parts tend to shift or slip in their relationship to each other. Besides that, I was never sure that all the solder melted and flowed.

A far better method, at least for me, is to apply flux to the surfaces to be joined and clamp them together. The adjacent surfaces are rubbed down with soapstone or a soldering "talc" crayon, which will prevent the solder from adhering to the exposed surfaces. Using a wire-type silver solder of 45- to 55-percent silver content, the joint and surrounding metal is heated until it just begins to turn red and the end of the solder touched to the joint. The application of heat is continued until the molten solder is visible all around the edges, at which time the heat is withdrawn and the work allowed to cool. Care must be taken not to overheat it since silver solder has a tendency to simply evaporate when overheated, and the fumes are toxic. The joint is then cleaned of the flux and soapstone residue, and any excess material is removed using files or scrapers.

Whether we like it or not, sooner or later we will be required to turn the outside of a barrel to a specific size and contour. The easiest way, as concerns the small shop, is to mount the barrel between centers in the lathe and set the tail stock

over enough to cut the appropriate taper. Since the breech end usually has a threaded shank followed by a straight tapered forward section followed by an abrupt taper or tapered curve, there is usually a length of 18 to 20 inches that consists of a straight, gradual taper usually of .150 to .200 inch over the entire length. This taper can be set up to give an almost exact measurement by mounting a dial indicator on the cross slide of the lathe and measuring the amount that the tail stock is set over. After a few passes are made with the lathe tool, and while the barrel is still oversize, the muzzle end and the point where the taper ends are measured. The amount of tail-stock set-over is changed to correct whatever error is present.

A steady rest can be used to support the barrel and dampen it to prevent chatter by offsetting the steady rest jaws to coincide with the tail stock offset, but it will require moving a couple of times. Usually there will be a slight step or ridge where the previous cut is stopped and a new one started. Therefore it is probably easier to turn the full length without using the steady rest, instead using a wood block held against the barrel to dampen the vibration and draw filing the entire length to remove tool and chatter marks, finishing with varying grits of bench strip.

When using high sights, it is extremely important that the sights stand exactly vertical, or straight up and down. This can present a problem, since these are not easy to hold in place with clamps or to determine when they are straight up. One way to do this is to clamp the receiver or barrel in the milling machine vise, making sure it is square and level. A rod with a sharp conical point is mounted in the mill collet. The sight assembly is located in place and held by pressure between the quill and mill table. A weighted string, or plumb line, is suspended from the ceiling directly in front of the work. Then, by sighting along the surface, the sight assembly can be aligned vertically with the string by moving the cross feed of the mill table until it is straight up and down, whereupon the sight assembly is silver-soldered in place.

Turning long firing pins can present a problem. The lathe tool must be sharp and set up to contact the material to be turned exactly on center. The material is mounted in the lathe with one end extending from the chuck for a short

distance and the free end supported by a center. This section is turned to size, taking light shallow cuts. It is then extended further and again turned to size. This is repeated until the entire length is formed. It is then mounted in the lathe chuck with just enough extending to turn the nose to its specified diameter, and the counter-stink end for the lathe center is removed. The hemispherical tip can be formed with a file and polished with abrasive cloth.

Coil springs must be supported for most of their length, either by an inside guide pin or a spring pocket enclosing most of the spring's length. Otherwise they may buckle and deform, rendering them inoperative. As used with triggers, sears, extractors, etc., spring pockets are drilled in the part to contain most of the length of the spring, thus supporting it around the outer surface. When coil springs are used as long, traveling hammer springs and the like, they must be supported by an internal guide rod. Many times, the compressed length should be taken into consideration when determining spring pocket depth and length of travel of moving parts. This is easily determined by multiplying the number of coils in the spring by the diameter of the wire that the spring is wound from.

There are times when it is important to determine thread depth, and no chart or table is on hand to refer to. The root diameter (the size of the screw shank remaining inside the threads) can be determined to within a couple of thousandths by dividing the pitch, or number of threads per inch, into 1.299. Since a 100-percent thread will not screw into a 100-percent hole, some clearance must be allowed. A 75-percent thread is an accepted standard. Therefore we would take the result of the division above and use 75 percent of it, which gives a satisfactory tap drill size or hole size in which threads will be machined.

When glass bedding or epoxy-based compounds are used to reinforce or fill gaps between wood and metal joints, it is absolutely necessary that any holes, depressions, cracks, seams, or anything else that this material may be forced into when drawn together be plugged or sealed to prevent such from occurring. Holes can be plugged with paraffin wax, cracks and seams taped over, and slots and depressions filled with wax. All surfaces except the ones the substance

is to adhere to must be coated with some sort of release agent to prevent them from becoming bonded together permanently. If no commercial release agent is available, automotive paste wax can be used. Give the exposed surfaces a thin coat and let it dry, then give them another coat. All screw threads must also be coated. Antifreeze that contains glycerine can also be used for this.

Shotgun bores and chambers, as well as rifle and pistol chambers, can be polished by slotting the end of a wood dowel, inserting one end of a strip of abrasive cloth or paper in the slot, and winding it around the dowel in the direction the work rotates. With the barrel held in the lathe chuck, the cutting end of the dowel is inserted in the bore, the lathe turned on, and the hand-held dowel moved slowly back and forth through the bore. The abrasive material should be a snug fit in the bore and will require frequent replacement. A final polish should be applied using 400 grit (wet or dry) paper followed by crocus cloth. Lubricant is used throughout the process. Chambers can be polished in the same manner by using correspondingly sized dowels. This is, more or less, a makeshift operation to be used in the absence of commercial hones and polishing heads. However if sufficient time and effort is invested, it will give good results.

When barrels are installed, either in receivers or mated to barrel extensions, they must be drawn up tight. When mated to a receiver, this is easily accomplished using a barrel vise and an action wrench. The barrel extension sometimes presents problems since it is difficult to fasten onto with a means to turn it. One way to tighten or remove it is to bore a pair of hardwood blocks to the same diameter as the extension. A clamp is made with a bolt on each side to fit over and contain the blocks. One leg of this clamp is either long enough to serve as a handle or turned to fit inside a length of pipe, which serves as a handle. This is used in the same manner as an action wrench.

Flat parts can be polished while retaining flat sides and sharp edges by placing abrasive cloth or paper on a sheet of plate glass and rubbing the part to be polished back and forth across it. As usual, progressively finer abrasive grits are used, as well as cutting oil.

Holes can be drilled or bored in the lathe and

shoulders and threads can be cut to exact depth by mounting a dial indicator on the lathe bed in a location where the stylus will contact the lathe carriage as it reaches the bottom of the cut. The indicator should be set up to stop on a number after the indicating hand has traversed the dial a couple of times, not just as contact is made. This will give ample warning before the stopping point is reached.

There are times when slots must be cut that cannot be reached with ordinary milling cutters. It is also difficult to cut such slots with a hacksaw, since succeeding saw cuts tend to slip over into the adjacent cut. If the mounting pins in the hacksaw are replaced with longer pins, more than one blade can be mounted simultaneously in the saw frame. This will allow wider slots to be cut at one time, with the slot width regulated by the number of blades used.

Most feeding problems in box-magazine guns can be alleviated by reshaping the magazine lips and/or follower. If the nose of the cartridge or shell tries to contact the top of the chamber before entering, the magazine lips should be bent inward slightly. Reshaping the

follower so that the forward end rides lower in the magazine may also correct this. If the shell hits at the bottom, the magazine lips are spread slightly or the follower is bent to ride lower at the rear. Sometimes the cartridge nose will hang on the left or right sides. This can usually be corrected by bending the lip slightly upward on the side the bullet should be steered toward, or by bending the opposite side downward.

When small boring bars are needed for use in the lathe and none are available, end mills can be mounted in the tool post (especially a four-way tool post) and one flute used as a cutting edge. The body should be angled just enough to provide clearance. You can't bore deep cavities with these, but they work in a pinch.

To obtain a good finish when turning plastic, as with forends, a sharp, round-nosed tool should be used. It should have twice as much clearance as used for cutting steel and no rake. The material is turned at a fairly high speed and fed slowly. This material must not be allowed to overheat since the surface tends to melt, spoiling the finished surface. Therefore, friction, the primary cause of heating, must be kept to a minimum.



Chapter

Building a Gun

16

Using what we have discussed and learned in the previous chapters, it is time to put it into practice and actually build a gun. The example used herein is a 12-gauge slide-action military and police gun with a 10-shot detachable box magazine. Other types and calibers can be fabricated using similar methods.

As recommended earlier, we will build the magazine first. Since it is not practical to form the compound curves required in the small shop, we will have to weld up the magazine body using four sheet metal components. Cut the two sides to shape, making sure they are identical, and the two end plates. These are bent to match the curves in the side panels. With the four parts clamped in their respective positions, the four seams must be welded for their entire length and then ground flat and smooth. This is a hard way to get a magazine, but at least it is a way. The bottom plate is cut to shape from the same 20-gauge sheet metal and the sides folded to correspond with the flanges bent outward at

the lower end of the magazine body. The follower is bent to shape as shown. Likewise the bottom cap retainer. The magazine feed lips are bent inward and welded to the backplate. A small block is silver-soldered in place on the backplate for the magazine latch to engage and hold the magazine in place in the gun. The spring should be wound or bent to shape from .065-inch spring wire, commonly known as piano wire or music wire.

The upper receiver is cut to length from 1 1/2 inch outside diameter 4130 seamless tubing with a .120 inch wall thickness. The front end is threaded to accommodate the barrel retainer nut and the various openings cut to the dimensions given. The blocks for the front and rear mounting bolts are welded in place on the lower side. A guide must be fastened inside the receiver to hold the bolthead in its open position during its fore and aft travel. Three 1/8-inch slots are milled in the upper receiver as shown and matching tabs milled on the guide. These are mated together and welded in place.

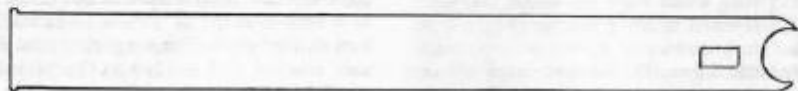
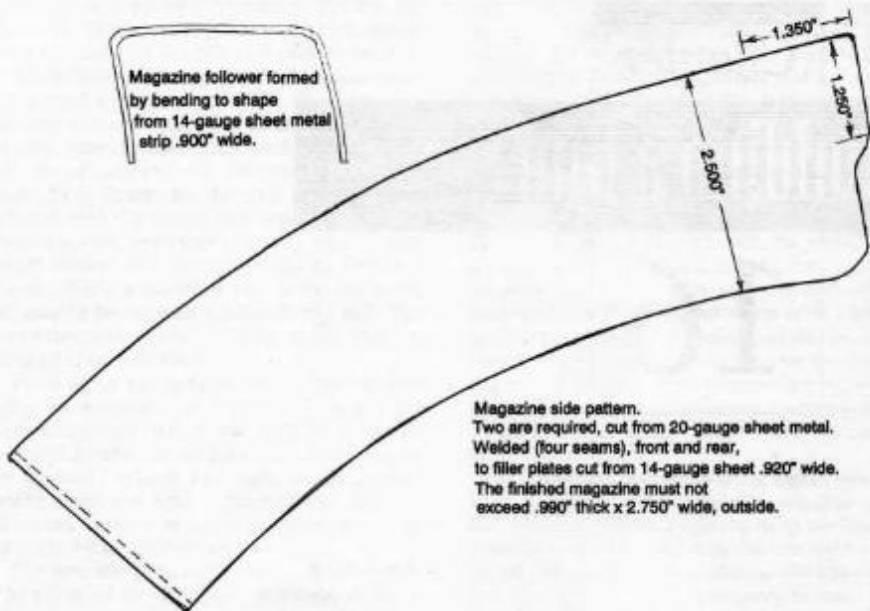
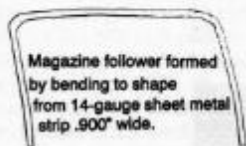

Magazine rear

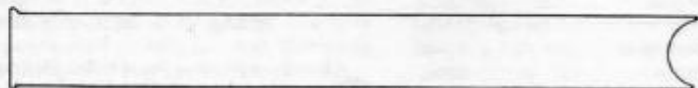

Magazine front

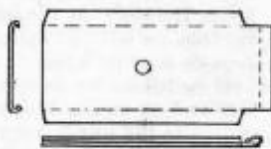

Magazine bottom



Magazine bottom retainer

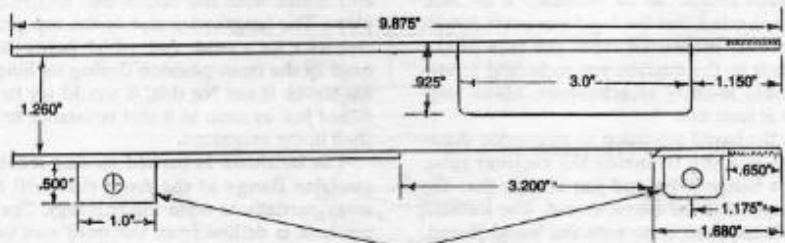

Blocks of 1/2" square mild steel
TIG welded to bottom of receiver.

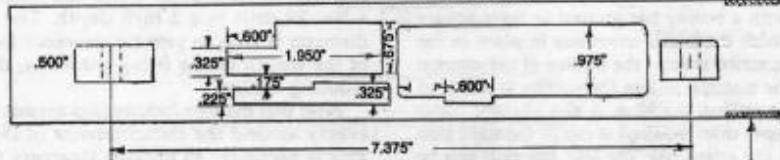

Upper receiver.

Use 1.500" O.D., 4130 seamless tubing (D.O.M.);
.120 wall thickness; no heat treatment required.

Thread 1.500" x 24"

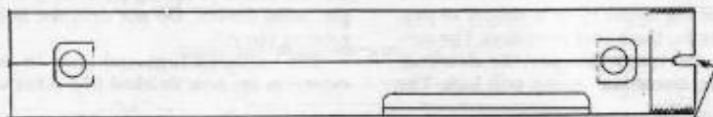

Upper receiver, top view.

Slot .300 x .125" for barrel indexing pin.

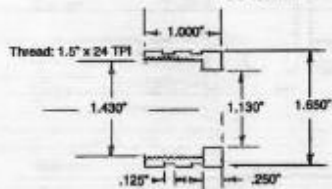

Thread: 1.5" x 24 TPI

Barrel retaining sleeve, turned from round stock.

A barrel is turned to the dimensions given. The overall length can be increased if desired, but keep in mind that the legal minimum length is 18 inches, measured from the face of the closed bolt to the muzzle, not including screw-detachable muzzle attachments. Make sure yours is at least that.

Turn the barrel extension to an outside diameter that is a slip fit inside the receiver tube, leaving a flange at the end just smaller than the root diameter of the barrel thread. The forward end is threaded to mate with the barrel thread. The rear end is tapered, forming a shallow approach cone. The counterbore for the bolt lugs is cut with a boring bar ground to form square edges. With the barrel extension in place in the receiver, scribe around the outline of the ejection port. The material within the outline is removed with the milling machine. A slot slightly wider and deeper than required is cut in the right side to clear the action bar. The bolt lug slots can be cut with a 1/2-inch end mill but should not be finished until the bolt is made.

The bolt body is turned to size and length and bored for the firing pin and bolthead. The function of the angled slot at the top is to cam the bolthead into and out of its locked position. The flat cut at the upper front is simply to provide clearance for the barrel extension. The narrow slots on the lower side provide clearance for the ejector, disconnector, and bolt lock. The

wide slot on the right side with the notch at the end mates with the action bar, securing it in place. The lengthwise slot at the top provides clearance for a guide rail, which holds the bolt-head in the open position during its longitudinal travel. If not for this, it would try to rotate closed just as soon as it met resistance from the shell in the magazine.

The bolthead is turned to size leaving an oversize flange at the front that will be cut away partially to form the bolt lugs. The firing pin hole is drilled from the front end into the bolt face with a No. 31 drill at least 1 inch deep. It is then reversed in the chuck and drilled with a No. 29 drill to a 2 inch depth. The larger diameter is only to provide clearance for most of the length of the firing pin body, thereby reducing friction.

Note that the four locking lugs are not spaced evenly around the circumference of the bolt. This is necessary to provide clearance for the ejector and the ejection port. The bolt lugs are formed by removing all excess material possible with the milling machine and finishing with files and abrasive cloth. A high-speed hand grinder is useful here. The extractor cuts can be made, as can the extractor spring pockets, and the hinge pin holes drilled. Do not drill the hole for the rotating pin yet.

The bolthead lugs and slots in the barrel extension are now finished to a point where the

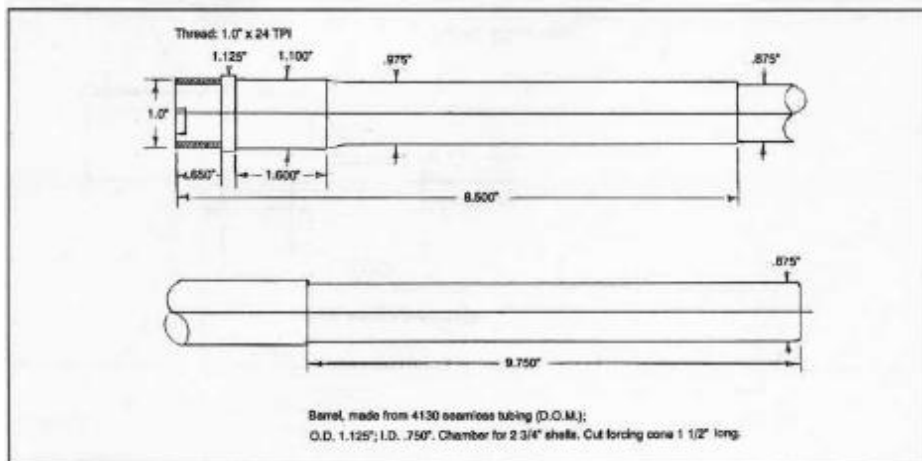

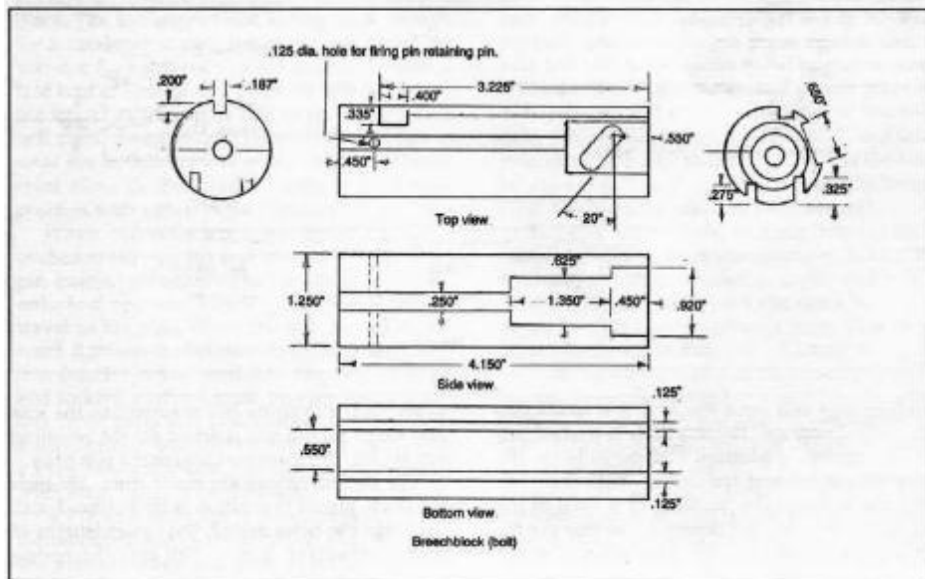
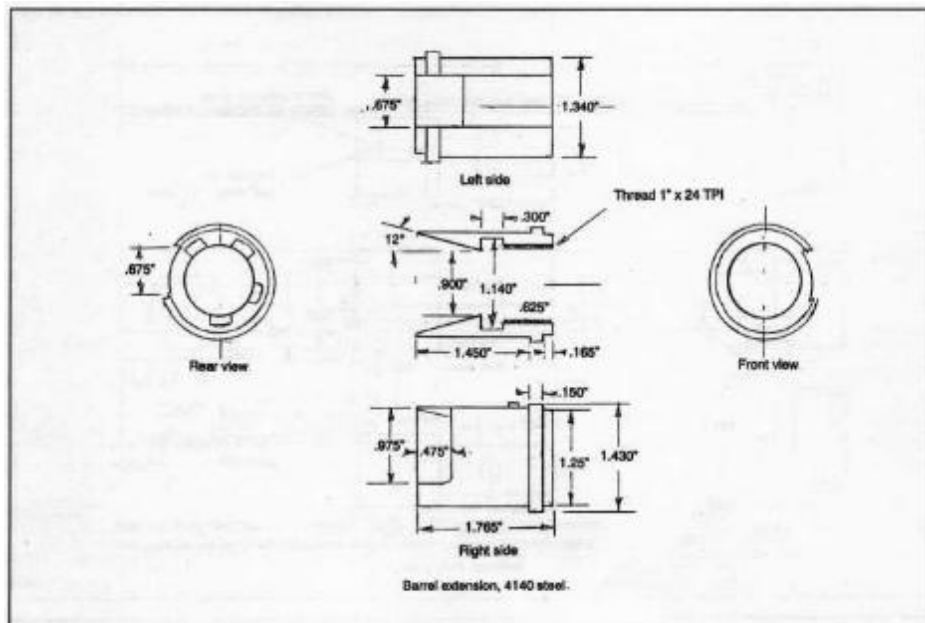

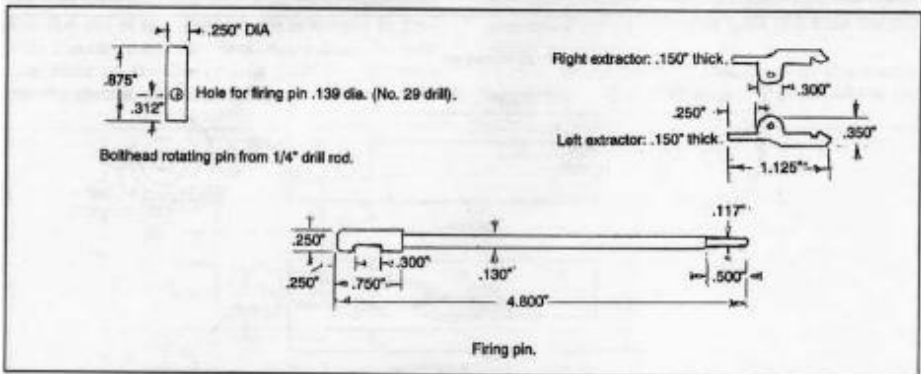
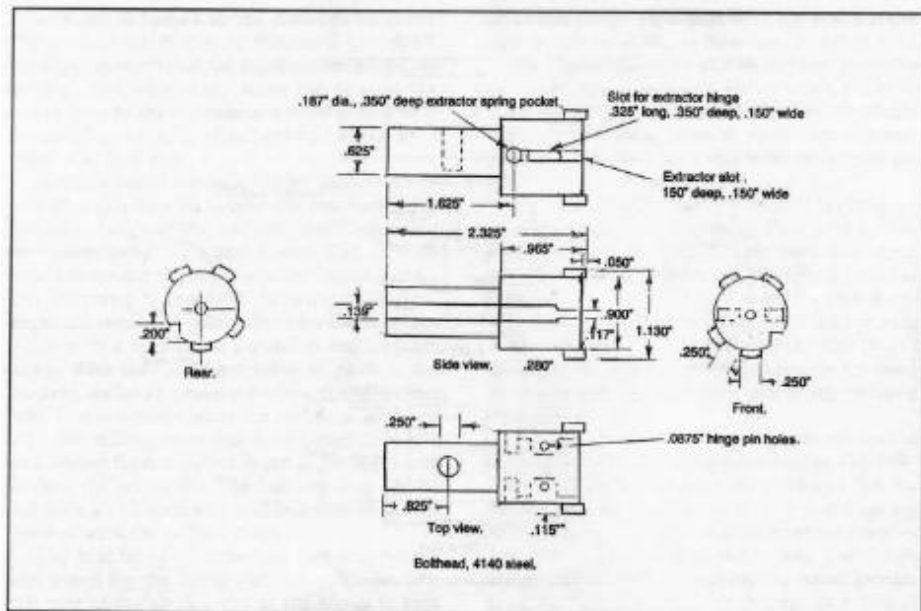

locking lugs will enter the slots and rotate into the locked position. The bolt body is pushed into its forwardmost position and the hole for the rotating pin is marked and drilled. With the rotating pin in place, the No. 29 drill is used in the firing pin hole to drill through it so that the firing pin fits through the rotating pin when

assembled. The firing pin is turned to the size and shape shown and notched for the retaining pin, which fits crosswise through the bolt body.

The two extractors are made from .156-inch flat stock, placed in position in the bolt head, and the hinge pin holes drilled. Two short lengths of small coil spring that will fit into the spring

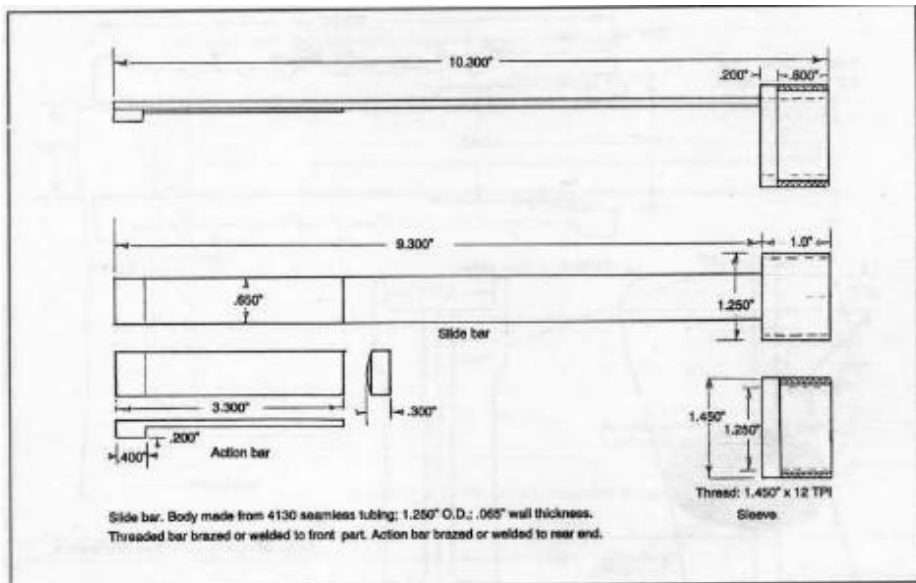

pockets are inserted and the extractors pinned in place. The extractors must spring open enough for a casehead to pass between them. Paint the extreme forward ends of the extractors with a thin coat of lipstick and push the bolt as far into the barrel extension as it will go. The lipstick will mark the barrel end where the relief cuts to clear the extractors will start. These relief cuts must allow the bolthead to rotate to the locked position with a shell in the chamber.

When correctly done, as the bolt body is pushed to the rear, the cam slot turns the rotating pin, causing the bolthead to likewise turn into the unlocked position, whereby the bolt is free to travel to the rear. When the bolt is pulled forward, it rotates the bolthead in the opposite direction into its locked position. The cam surfaces and locking surfaces must be very smooth and free from burrs and tool marks. A worthwhile finishing touch is to coat the mating surfaces with a very fine-grit paste lapping compound and work them together until smooth.

A 1/8 inch wide slot is cut through the top of the threaded end of the receiver. This begins at the forward edge and extends to the rear 1/4

inch. Slide the barrel assembly into the receiver and turn it to the exact position it will be in when finished. Using the slot just cut as a guide, drill a hole 1/8 inch deep into the barrel extension using a No. 31 drill. Taper the end of a short piece of 1/8-inch drill rod slightly and drive it into this hole. It must then be ground off until it only projects about .080 inch above the surface of the barrel extension. This pin serves to locate the barrel consistently during takedown and assembly.

The action bar should be made from 1/4-inch outside diameter seamless tubing with an .065 inch wall thickness. A section at one end is left in the solid diameter and the remainder cut away, leaving a strip 5/8 inch wide. This strip serves as the action bar. A short length of 1 1/2-inch tubing with a .120 wall thickness is threaded, cut to length, slipped over the full diameter portion of the action bar, and silver-soldered in place. The action bar lug is attached to the other end in the same manner.

Make the forend by boring a hole lengthwise through a piece of 2 inch diameter black nylon that is cut to the desired length and the ends squared. The hole should be slightly larger than

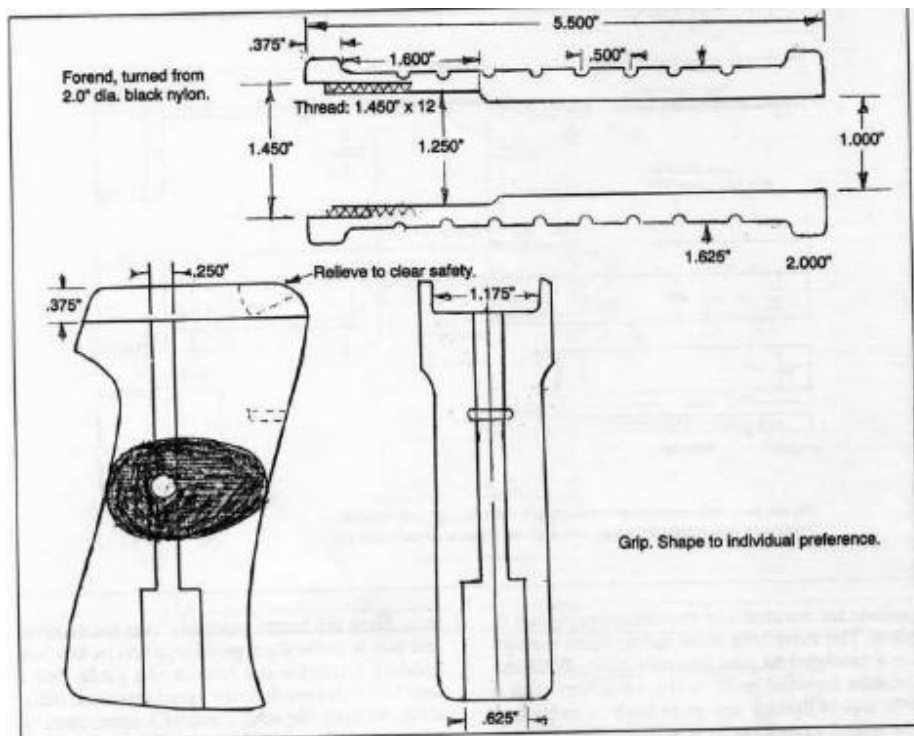

the barrel diameter. One end is bored and threaded to screw onto the action bar. The outside is turned to the shape shown, or whatever contour suits you.

A barrel-retaining nut is made and threaded to screw onto the receiver, bearing against the flange at the front of the barrel extension and holding the barrel in place. The outside diameter should be knurled. Both for appearance and to facilitate tightening and loosening by hand. Knurled surfaces can be enhanced appearance wise by leaving narrow bands along the surface with slight grooves between them and knurling the bands. Using this method, the knurling tool is fed straight in, without sideways movement, on each raised band. This results in sharp, well-defined, even diamonds that may be hard to obtain in a continuous lengthwise knurl.

If the muzzle brake is used, a front sight can be made by cutting an M16 front sight shorter and silver soldering it to the body, or an adjustable front sight can be made as shown in Chapter 15.

If everything is the way it should be, you should be able to put the upper receiver/barrel assembly together now. Screw the forend on the action bar, put the barrel nut over the action bar, and insert the barrel inside. The bolt is added in place and the assembly inserted into the receiver. The barrel nut is screwed onto the receiver, forming a solid assembly.

The rear sight/carrying handle assembly is cut from 14-gauge sheet metal and bent to shape around a form block. The lower legs are bent to shape and a 1/4-inch hole drilled through each of the mounting tabs. It is now located in place

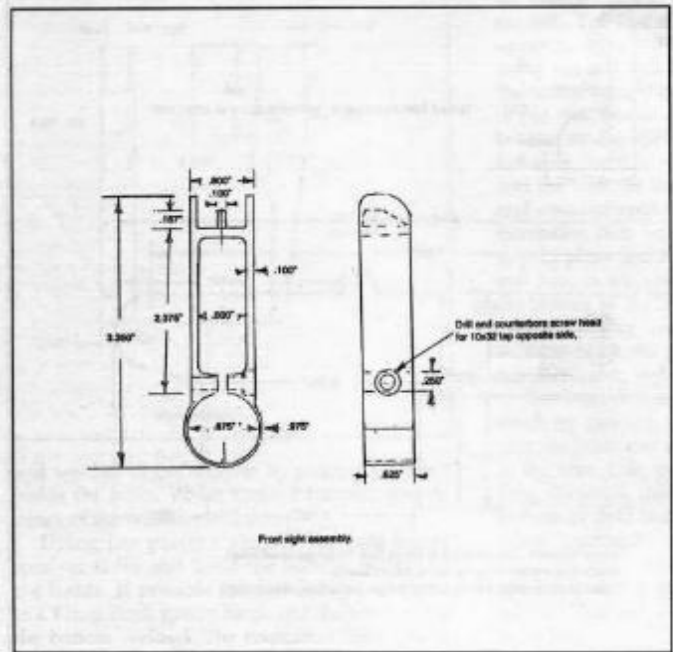
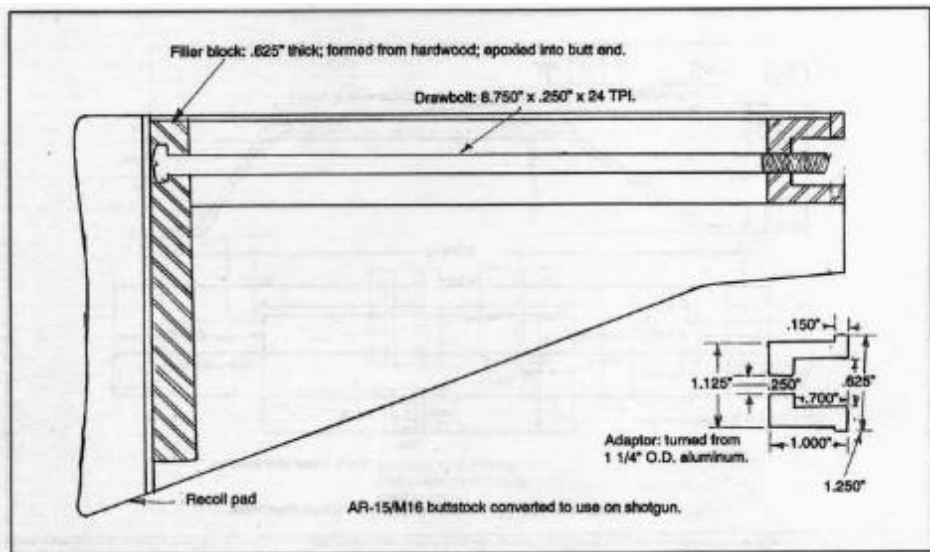

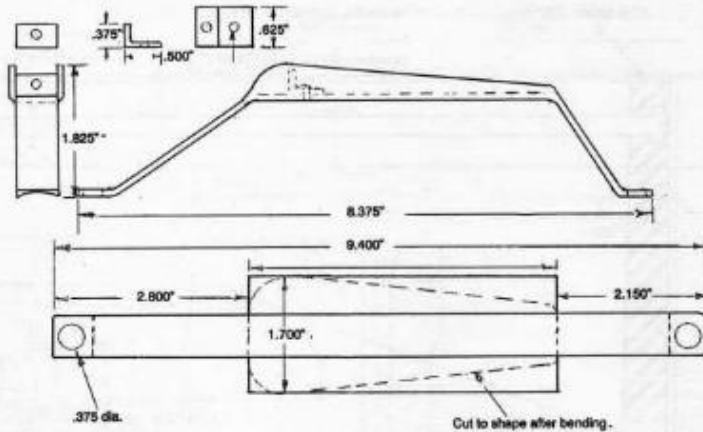

Carrying handle/rear sight folded to shape from 14-gauge sheet metal.

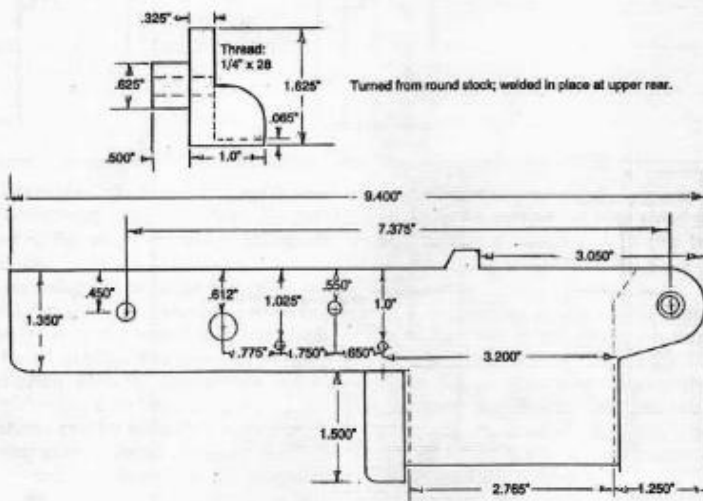

Lower receiver. Two sides cut to shape from 14-gauge sheet metal, folded and welded along bottom and front seams. Filler blocks welded at front, behind magazine opening, and at rear.

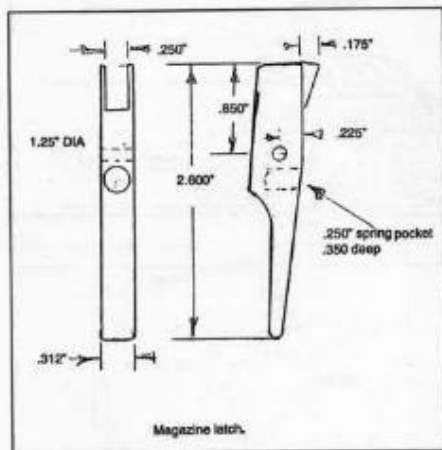
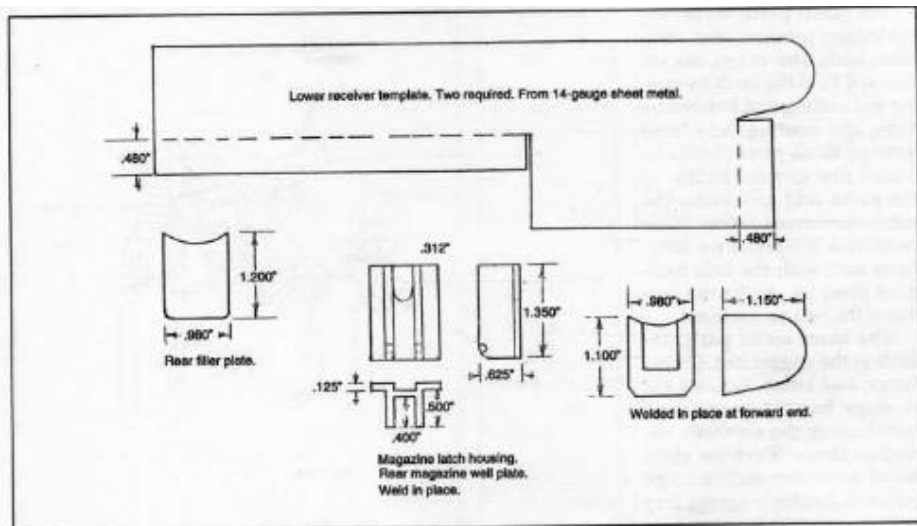

and welded to the receiver by putting the weld inside the holes. When dressed smooth, no evidence of the welding will show.

Using the pattern shown, cut two lower receiver sides and bend the bottom flanges to the inside. If possible these should be clamped to a 1 inch thick spacer block and the seam along the bottom welded. The respective filler blocks

are then welded in place and the seams ground smooth. The upper side that mates against the upper receiver is milled flat and radiused inside using a 1 1/2-inch ball cutter to a close fit with the round-bodied receiver. The front filler block is cut out to mate with the front mounting bracket on the upper receiver. When fitted satisfactorily, both receivers are clamped together and the hole for the crossbolt drilled, threaded, and counterbored for the screw head. The grip mounting bolt hole is located by holding the grip in place and marking the hole through the bolt hole in the grip. This hole extends through the bottom of the lower receiver and through the rear mounting bracket, which is threaded to accommodate the grip bolt that holds the grip, lower receiver, and upper receiver together.

The buttstock is adapted from a surplus M16 stock by turning an aluminum bushing to fit into the front end of the stock and a similar one at the rear. This assembly is held in place by a long drawbolt, made by threading one end of a section of drill rod and welding a head on the other. A screwdriver slot can be cut with a hacksaw. This stock, as it stands, will be too short, so the buttplate is ground flat and a recoil pad added. This will lengthen the stock by as much as an inch.

The small parts, including the trigger, hammer, sear, magazine latch, and others, are cut to shape from flat stock by sawing and milling and finished by filing and sanding. Any holes through these parts should be drilled first and the outline of the parts laid out using the holes as reference points. Make cardboard templates for these parts and, with the hole locations lined up, scribe the outline of the part on the metal.

The sheet metal parts, including the trigger bar, disconnector, and action lock, are cut to shape from 14-gauge sheet metal using the methods described above. Since the sheet metal doesn't contain enough carbon to harden properly, they will require surface, or case hardening. This is easily accomplished using the Kasenit treatment described elsewhere.

The coil springs required can usually be found in hardware stores, auto parts stores, and gunsmith supply houses. I used an M16 hammer spring in this gun, as I have before in a number of gun designs, because it is cheap, dependable, and available. These are advertised by surplus parts suppliers at prices from \$1 up, which I consider a bargain.

The magazine latch, or retainer, is fitted easily by first drilling the hinge pin hole through the lower receiver. Then, with the magazine in place, the latch is placed in position with the upper end bearing against the block on the back of the magazine and the hole drilled using the hole through the receiver as a drill bushing. This should require little or no further fitting.

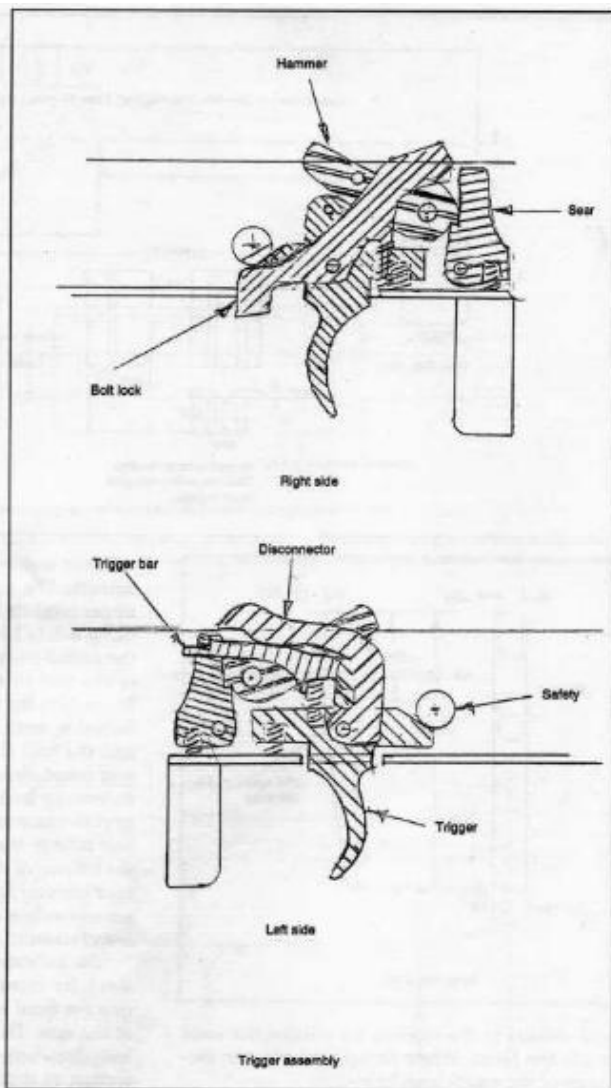

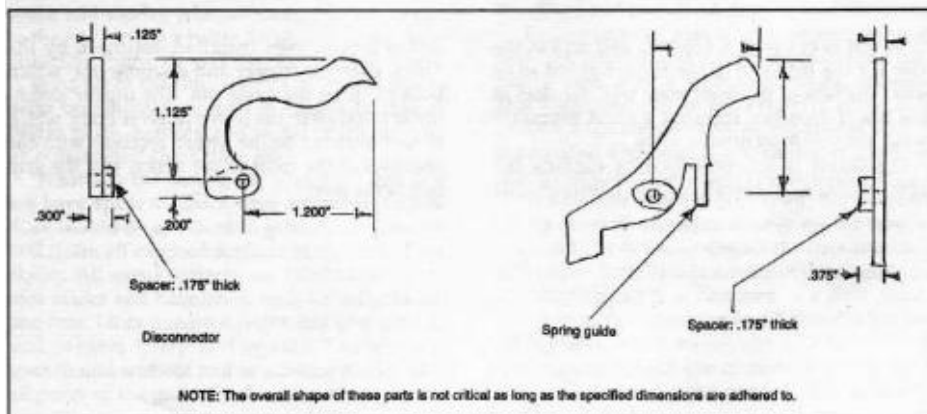
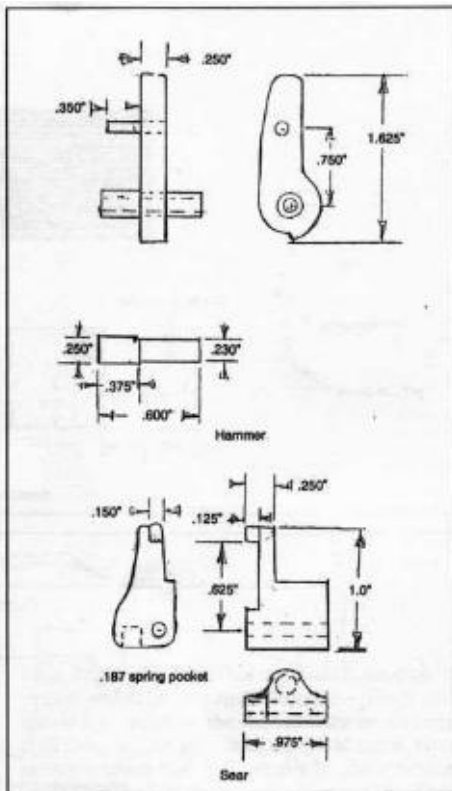
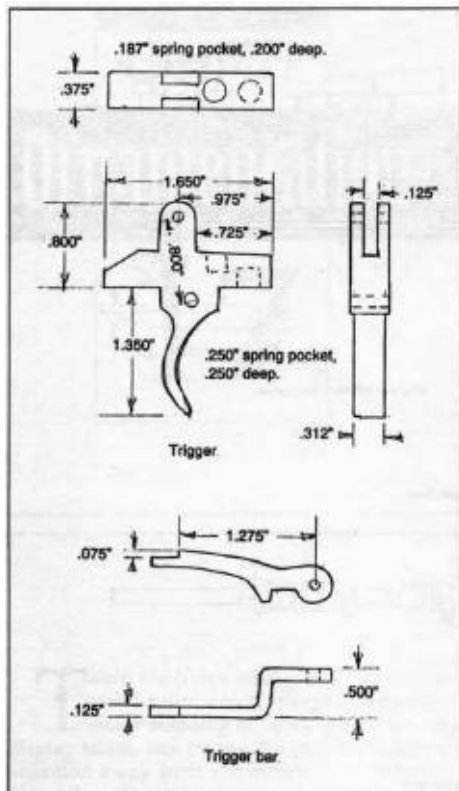

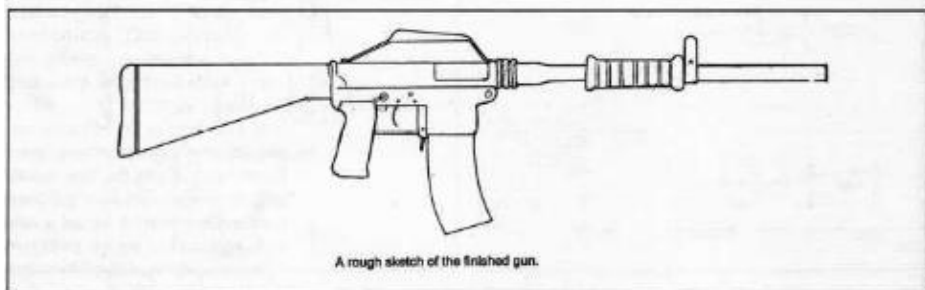
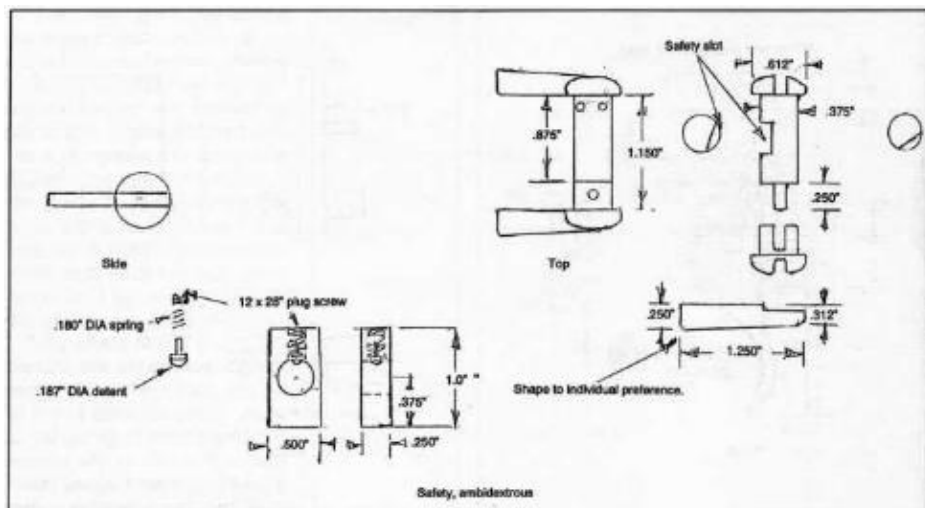

A slot is cut with a 1/8-inch end mill in the grip for the rear end of the trigger guard to fit into. The tabs at the front mate into the slots in the lower receiver, forming a solid assembly when the grip is secured in place.

Assembly is accomplished by pinning the sear in place, followed by the hammer. The

action lock is then installed, followed by the safety, then the trigger and disconnector, which both pivot on the same pin. The trigger assembly is installed in the lower receiver body, which is then secured to the upper receiver with the crossbolt at the front of the action and the grip bolt at the rear.

Manufacturing guns

Now that you have been introduced to the basics of gun manufacturing, let us expand our horizons a bit.

3D Printed guns

There are 3 relevant fully 3D printed guns: the PM522 Washbear revolver, the Liberator single shot and Grizzly rifle. All 3 use the .22 calibre which is weak and should therefore be only considered as a secondary option. It is also possible to 3D print the lower receiver for many guns including most notably the AR-15, though you require an upper receiver to complete the weapon, meaning this is more for repairing damaged weapons rather than manufacturing.

FOSSCAD 3D Printing repo:

<https://github.com/maduce/fosscad-repo?files=1>

All the CAD files:

<https://fosscad.org>

Downloadable printed gun materials: <https://github.com/maduce/fosscad-repo/tree/master/Firearms>

More uploads: <http://codeisfreespeech.com/>

Grabcad for more weapon CADs:

https://grabcad.com/library?page=1&time=this_month&sort=most_downloaded&categories=3d-printing,military

Check out the CAD section on: <http://rifleconnection.com/>

Liberator (Download, contains STereoLithography CAD .STL files) - The Liberator is a physibile, 3D-printable single shot handgun, the first such printable firearm design made widely available online, designed by Defense Distributed.

http://herohog.com/GunBuilds/Liberator_STL_Files.zip

“80%” AR-15 Lower: Machining Instructions (Download) - SolidWorks CAD Code (Download)

http://herohog.com/GunBuilds/ar15_lower_machining_Instructions.pdf

http://herohog.com/GunBuilds/ar15_80_percent_lower.zip

Complete AR-15 (Download, contains SolidWorks CAD Code)

http://herohog.com/GunBuilds/ar15_complete.zip

Complete AR-10 (Download, contains SolidWorks CAD Code)

http://herohog.com/GunBuilds/ar10_complete.zip

Ruger 10-22 (Download, contains SolidWorks CAD Code)

http://herohog.com/GunBuilds/ruger_10-22_complete.zip

1911 (Download, contains SolidWorks CAD Code)

http://herohog.com/GunBuilds/1911_complete.zip

vz 58 (Download, contains SolidWorks CAD Code)

http://herohog.com/GunBuilds/vz58_complete.zip

Beretta 92FS (Download, contains SolidWorks CAD Code)

http://herohog.com/GunBuilds/beretta_92fs_complete.zip



In the following sections we will cover manufacturing the following firearms:

- AK47 – Partial build
- 9mm Pistol – Full build from scratch
- 9mm SMG – Full build from scratch
- 12 Gauge Shotgun – Full build from scratch

These basic weapons should suffice for most guerrilla activities, especially in an urban setting. Perhaps you are facing an armoured enemy, or you need to fight at range, either way: do not fear. The weapons included in the guides can be modified to operate at longer range by modifying them to accept larger (7.62mm NATO) rounds and increasing their barrel length. Additionally, adjust the barrel rifling and make sure to account for headspace. In order to design appropriate weapons, let us briefly discuss the key differences between an SMG, Battle Rifle a Sniper/Designated Marksman Rifle and an Assault Rifle.





You will notice that the SMG is smaller than an Assault Rifle, and has a smaller magazine. This is very important as the above SMG is a MP5 which fires 9mm pistol ammo while the bottom image is of a M4 which uses the 5.56 NATO round.



This image shows the size difference between the two cartridges.

SMGs are smaller and they have a much smaller effective engagement range than an assault rifle does. The assault rifle has a much more powerful and faster bullet combined with a longer barrel allows for better accuracy. Usually, Assault Rifles have the ability to fire semi-automatically (one round fired each time you pull the trigger) while SMGs usually can only go full-auto("machine-gun" mode).

Summary: SMGs are very compact short range weapons that fire a less powerful round while Assault Rifles are larger and usually are effective at longer ranges as well as short range, they also fire a more powerful and damaging bullet.

Basically, that is it. Barrel lengths on the assault rifle will be longer, cartridges will have more power. Ammo for the SMG will be lighter, but will have less power. It's more of a shades of grey thing, going from SMG, to Assault Rifle. Both lack the range of a full battle rifle, but the BR lacks the auto fire and maneuverability of the SMG or the AR.

The battle rifle, the designated marksman rifle (DMR) and the attack rifle (AR or carbine) each indicates a category. In chronological order the battle rifle was the first which appeared on the battle fields. Battle rifles chambered for rifle cartridge which is enough powerful and effective to shoot over 800 meter. This power often was needless during WW II so a new category, the latest generation of firearms had been emerged: the carbine (or nowadays AR). Carbine originally a French word means "short barrel, lightweight cavalry weapon". In practice they are extremely practical in CQC (close quarter combat), nowadays these are the individual weapon of soldiers. It can be shot aimed fire 300-400 meters. DMR is a newly created concept. Designated marksman uses a multi purpose (and NOT a purpose-built sniper rifle) weapon with enhanced aiming capabilities. DMR can be a carbine (such as M16A4) or battle rifle as well (M14 EBR - Enhanced Battle Rifle). The DM is increasing the squad / fireteam's capabilities to engage targets to approximately 600 meters where the standard service rifles would be ineffective. But a DM is not equal with a sniper (nor his weapon, nor his training as well).

Pictures are worth a thousand words. We will include some diagrams of common firearms of the Assault, Sniper/Carbine, Battle classes, ask yourself: can you identify the differences?

SKS Sniper Rifle (Carbine) Diagram

Parts Legend

- | | |
|----------------------------------|----------------------------------|
| 1. PISTON | 29. TRIGGER GUARD SPRING |
| 2. HANDGUARD AND GAS CYLINDER | 30. MAGAZINE |
| 3. PISTON EXTENSION | 31. MAGAZINE FOLLOWER |
| 4. PISTON RETURN SPRING | 32. FOLLOWER SPRING |
| 5. FRONT SIGHT | 33. HINGE PIN |
| 6. FRONT SIGHT SEAT | 34. MAGAZINE COVER |
| 7. PISTON LOCKING LEVER | 35. COVER LATCH |
| 8. BAYONET SCREW | 36. LATCH SPRING AND SEAR SPRING |
| 9. BAYONET ASSEMBLY | 37. SEAR |
| 10. HOLD OPEN LATCH PIN SPRING | 38. LATCH STOP PIN |
| 11. HOLD OPEN LATCH SPRING | 39. TRIGGER GUARD |
| 12. HOLD OPEN LATCH | 40. DISCONNECTOR HINGE PIN |
| 13. RECEIVER AND BARREL ASSEMBLY | 41. TRIGGER PIN |
| 14. TAKEDOWN LATCH | 42. SAFETY CATCH |
| 15. TRIGGER GUARD LATCH | 43. SAFETY CATCH SPRING |
| 16. LATCH PIN | 44. TRIGGER |
| 17. RECEIVER COVER | 45. SAFETY CATCH PIN |
| 18. BOLT CARRIER | 46. TRIGGER BAR |
| 19. BOLT | 47. TRIGGER BAR PIN |
| 20. FIRING PIN RETAINER | 48. TRIGGER SPRING |
| 21. FIRING PIN | 49. DISCONNECTOR |
| 22. EXTRACTOR SPRING | 50. REBOUND DISCONNECTOR |
| 23. EXTRACTOR | 51. HAMMER |
| 24. RECOIL SPRING | 52. HAMMER STRUT PIN |
| 25. SPRING RETAINER | 53. HAMMER STRUT |
| 26. LARGE SPRING GUIDE | 54. HAMMER SPRING |
| 27. SMALL SPRING GUIDE | 55. CLEANING ROD |
| 28. STOCK ASSEMBLY | |

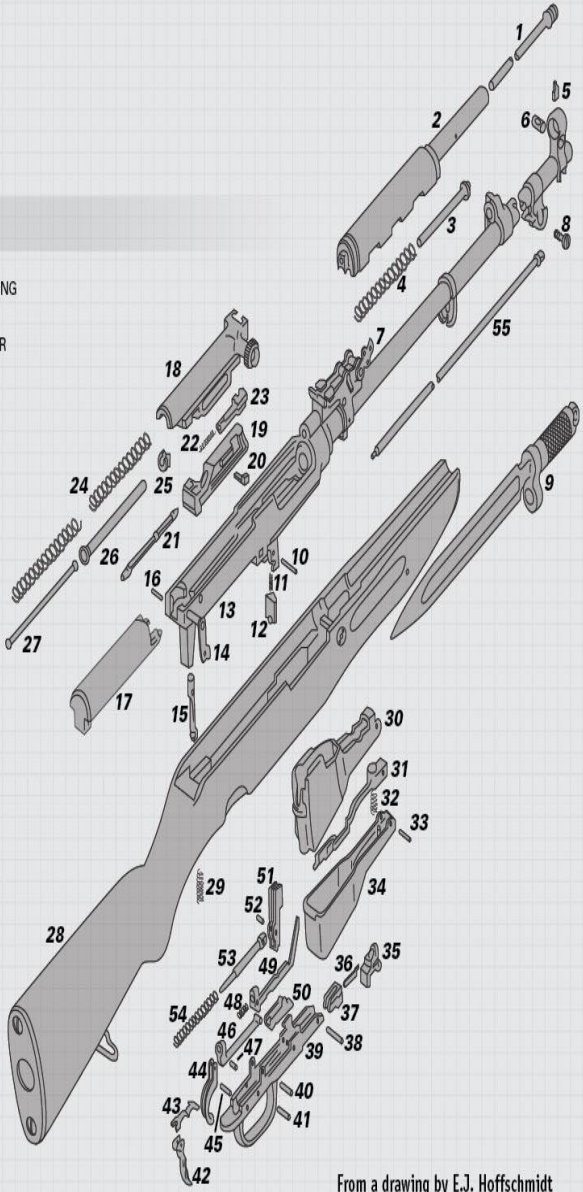

From a drawing by E.J. Hoffschmidt

FN FAL Battle Rifle Diagram

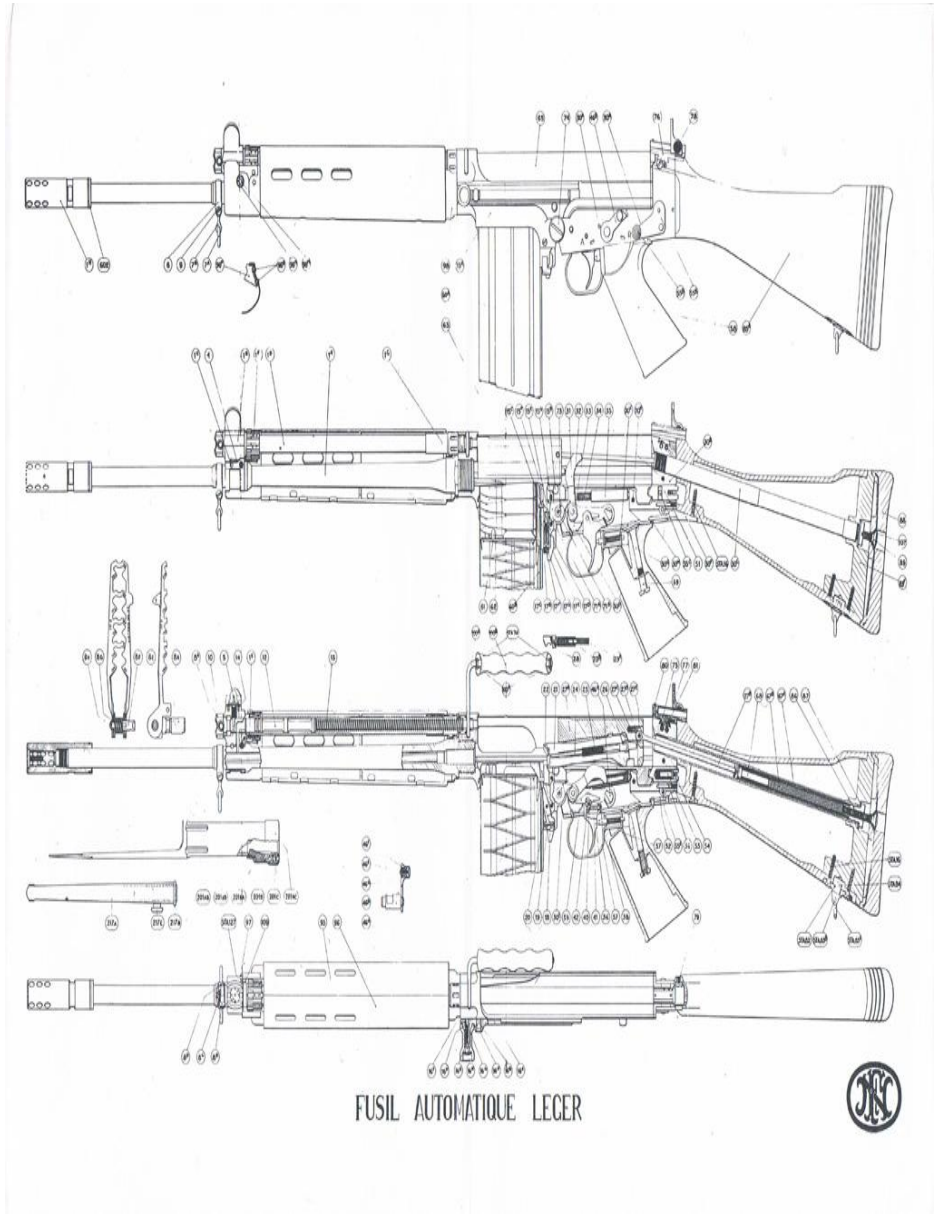

AR-15 Assault Rifle Diagram

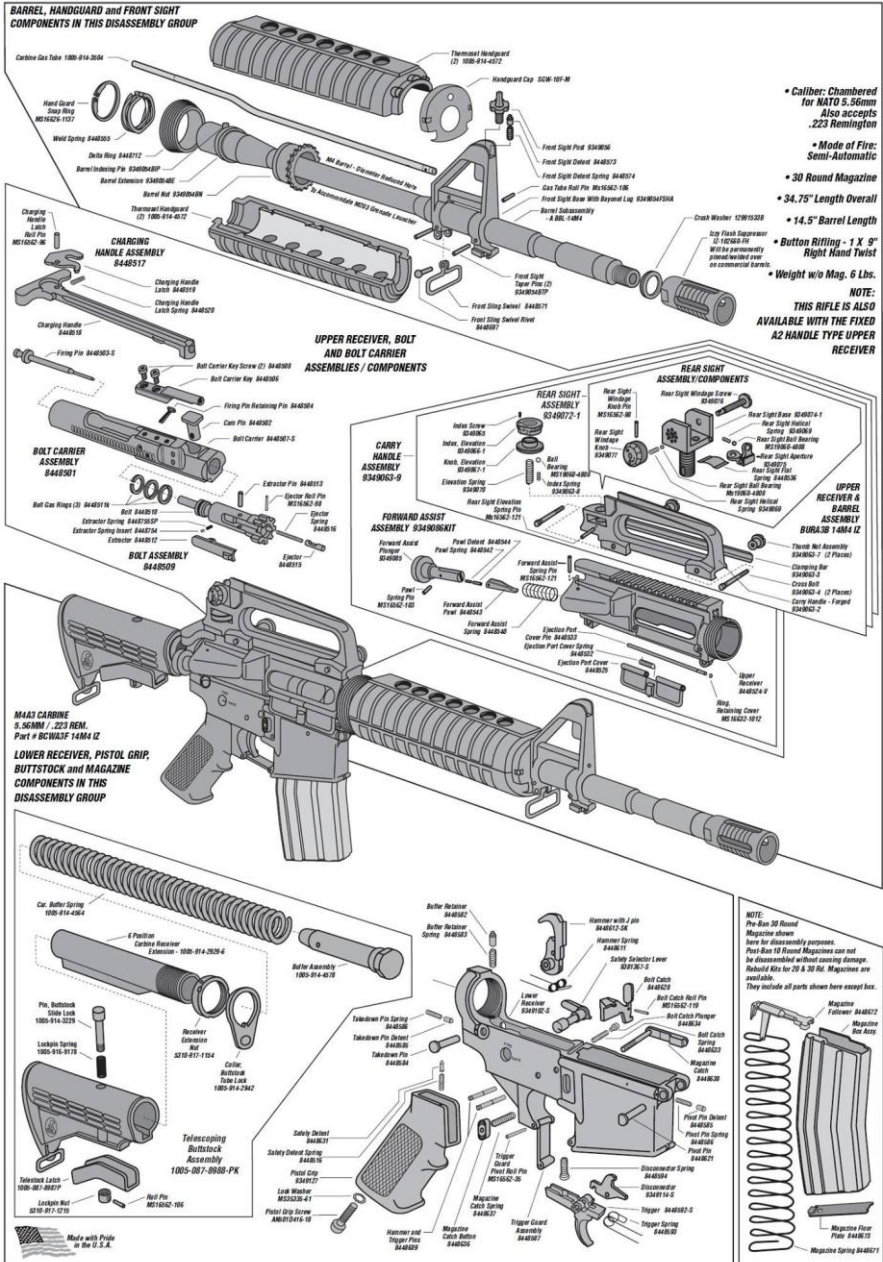

- Caliber: Chambered for NATO 5.56mm
- Also accepts .223 Remington
- Mode of Fire: Semi-Automatic
- 30 Round Magazine
- 34.75" Length Overall
- 14.5" Barrel Length
- Button Rifling - 1 X 9" Right Hand Twist
- Weight w/o Mag. 6 Lbs.

NOTE: THIS RIFLE IS ALSO AVAILABLE WITH THE FIXED A2 HANDLE TYPE UPPER RECEIVER

NOTE: Pre-Bus 30 Round Magazine shown here for disassembly purposes. Post-Bus 10 Round Magazine can not be disassembled without causing damage. Hybrid M4 for 20 & 30 RM. Magazines are available. They include all parts shown here except box.

Note: Home Workshop Guns for Defense and Resistance Volume V The AR-15/M16 by Bill Holmes is a DIY AR-15 or M16 guide.

AK 47

The holy grail of gun enthusiasts and resistance fighters alike is the AK. Unfortunately, without a parts kit, manufacturing one from scratch is extremely challenging. Here however is a good basis to expand from. There are many different ways to build the many different AK variants. But most methods are applicable across the different types. My advice is to read as much as you can about the different build techniques. So that you can choose the ones that are right for your tool and skill set. There are basically two different types of AK's - milled and stamped. Milled is a receiver that has been cut from a solid block of metal. Stamped has a receiver made from bent sheet metal. You'll probably be starting with the latter. Further, most countries standard issue military AK47's are very very similar in construction. With the exception of Hungarian. And especially Yugoslavian. (Which isn't bad. The Yugo is arguably the strongest AK made. As it starts with an RPK trunnion. And all around beefier components.) The main difference in your build will be stamped versus milled. And standard AK vs Yugo. And whether you use rivets or screws to attach the receiver together with the rifle.

With a stamped build you will be starting with a replacement stamped sheet metal receiver. (Or building one from scratch - also called building from a "flat".) Or you will be welding a milled receiver back together. Or starting with a new milled replacement receiver. Then you will either be attaching your receiver with rivets (the traditional way) or with screws. I prefer rivets. But you'll have to decide that on your own:

Build an AK from two different perspectives
<http://www.ak-47.us/build/Home-Build-001.php>

Further links:
<http://blog.legionarms.com/2010/09/building-instructions.html>

AK47, AKM, and AKS Blueprints:
<https://yadi.sk/d/IKpZo6MxscS54>

Further Firearm Blueprints can be found in:
<https://8ch.net/k/res/592866.html>

Now for the part you have been waiting for... here are 3 guides which are easy and cheap to follow at home:

- 1) Manufacturing a 9mm Pistol
- 2) Manufacturing a 9mm SMG
- 3) Manufacturing a 12 Gauge Shotgun

But first... do you lack the machines necessary for manufacturing? Did you know that you can also build all those machines from scrap material? Perhaps you won't find every tool, but The MultiMachine – a complete machine shop in one tool by Pat Delany is a good place to start. For the rest, buy the tools as necessary.

MultiMachine, an open-source machine tool

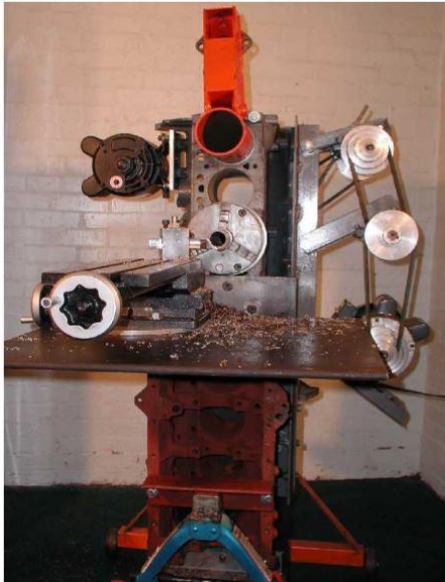

The MultiMachine -- a complete machine shop in one tool. Entirely built from scrap material.

Pat Delany
MultiMachine
Box 1629, Palestine, Texas 75801 USA
903 723 0980

1. 9mm Pistol

The following guide is from Practical Scrap Metal Firearms Volume 13 9mm semi automatic closed bolt pistol by Professor Parabellum. See it for measurements.

For more easy to follow pistol design guides see Practical Scrap Metal Small Arms Volumes 1, 4, 7, 11, 15, 16, 17, 18, 19 by Professor Parabellum.

9mm semi automatic pistol

(Closed bolt striker fired operation)



Note: the guide for making a magazine is taken from another gun build guide called Expedient Homemade Firearms The 9mm Submachine Gun by P.A. Luty. It will probably not fit exactly into the pistol so make sure to measure beforehand or

avoid using a STEN magazine.

Receiver

For academic study purposes only

247mm long

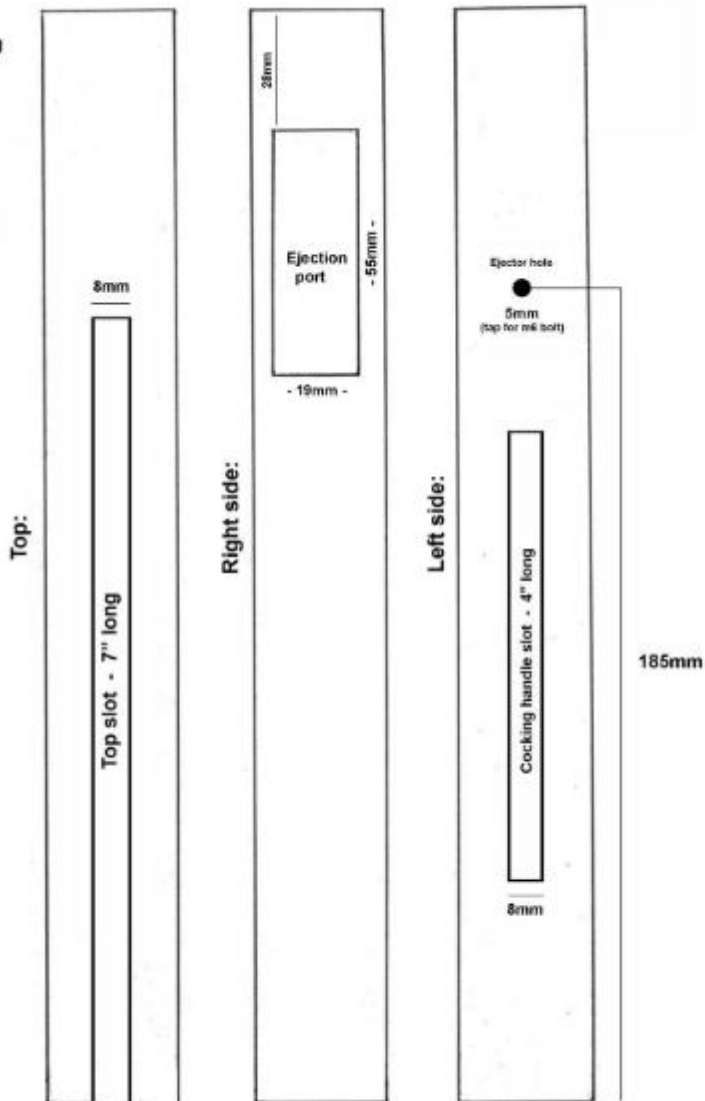

2 inches

Print on 8.5x11 US letter paper

30mm dia mild steel round tube
2mm thick wall

Receiver (Bottom)

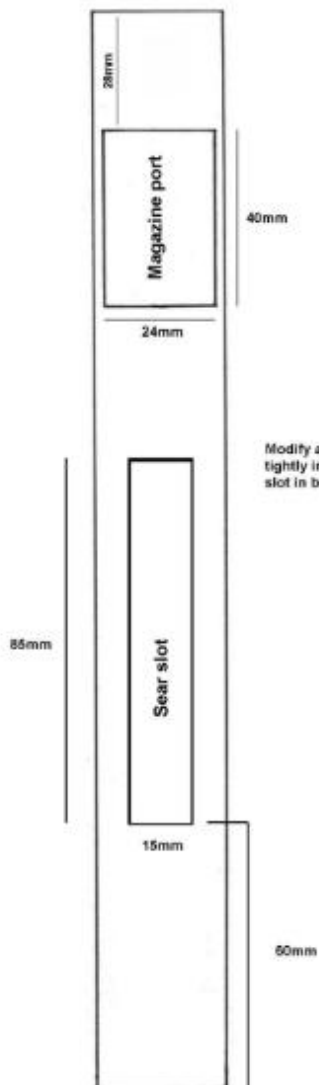

Ejector

Modify a 1/2" long m6 bolt into a blade profile. Screw tightly into the ejector hole until aligned with slot in bolt. Apply loctite to fully secure.

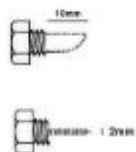

2 inches

Print on 8.5x11 US letter paper

Complete upper receiver

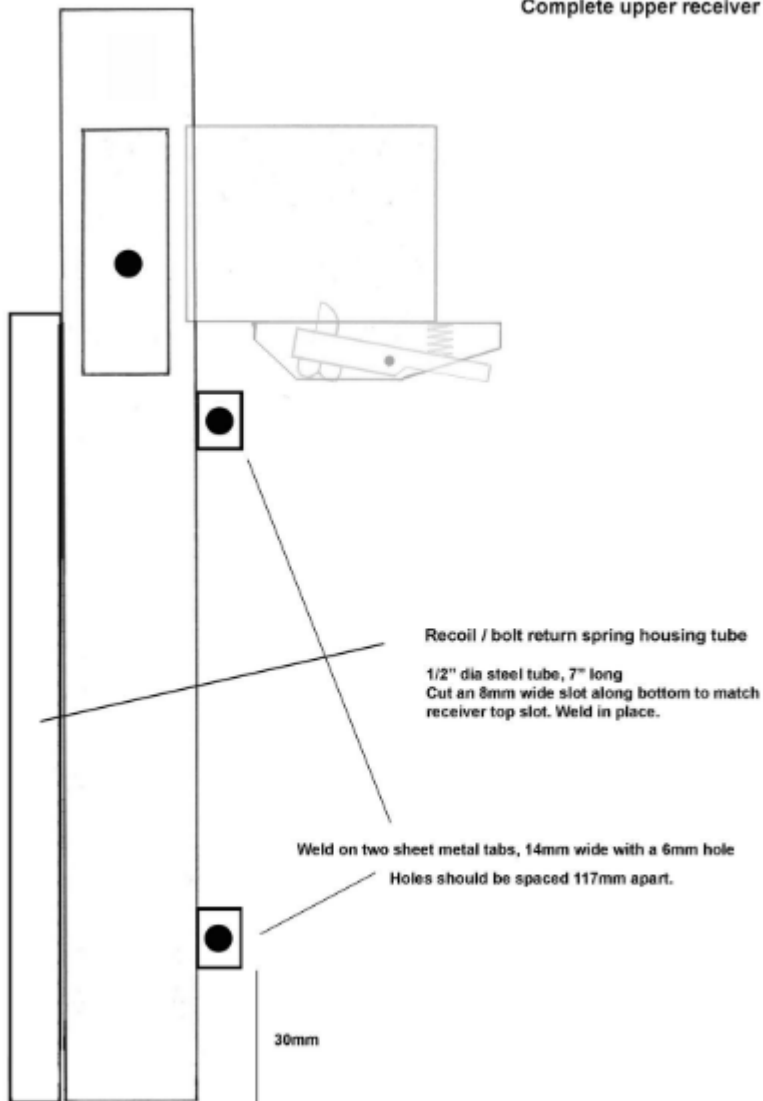

Magazine-well (for 9mm STEN magazines)

A 57mm length of 1" x 2" (25mm x 50mm x 2mm wall) steel rectangular tube is modified by removing a single 1" side to enable both 2" sides to be flared out slightly in order to accept a STEN magazine. A section of 1" steel bar can be hammered down through the opened side to achieve this. The removed side is then welded back into place forming the correct inner dimensions. Use a STEN magazine for reference throughout.

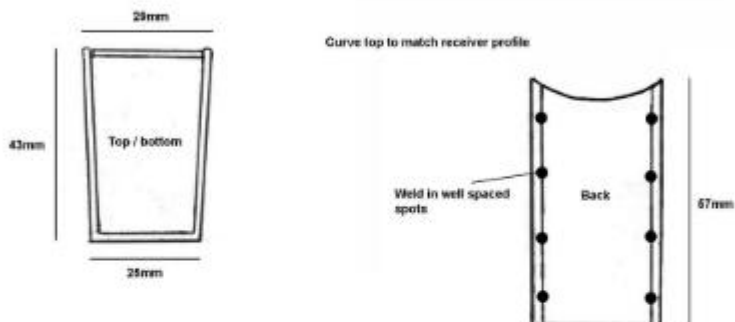

Magazine catch housing

Make using a length of 15mm steel square box section or bend from sheet.

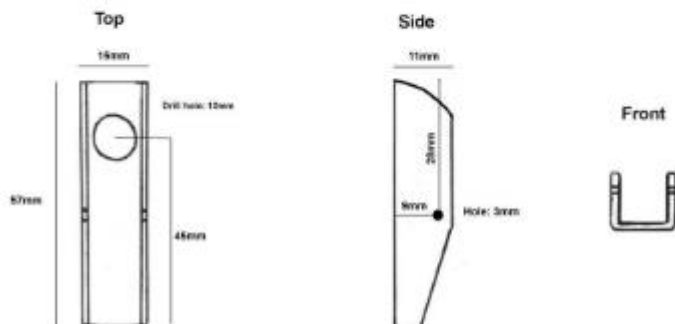

2 inches

Print on 8.5x11 US letter paper

Magazine latch

Assemble from a strip of 6mm (1/4") thick aluminum or plastic plate + M6 bolt

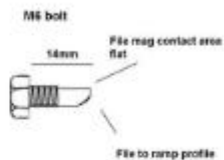
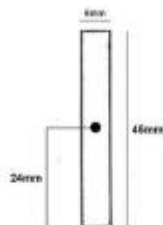
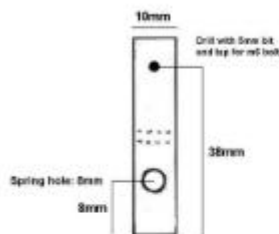

Tightly screw into plate and modify as above while in place.

8mm x 15mm compression spring



Finished:

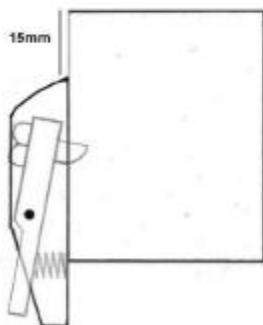
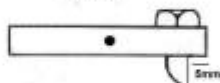

Drill through both pieces with 10mm bit

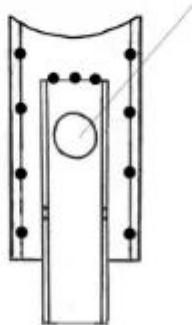

Latch should contact this point on a 9mm STEN magazine



- Weld latch housing to mag-well
- Secure latch with M3 bolt + nut

2 inches

Print on 8.5x11 US letter paper

MAGAZINE CONSTRUCTION

Probably the most important part of any automatic firearm is the magazine. Without it, the machine gun or semiautomatic can be no more than a single-shot weapon. Making a magazine in the usual way by bending a section of sheet steel around a forming block is a difficult and time-consuming process. We will not discuss this method of construction here, as it is not my idea of an easy-to-make improvised magazine. As with the other major component parts, a perfectly functional magazine can be made from a length of 34.93 x 15.88 mm ERW 16-gauge tubing (i.e., 35 x 16 mm tube). The magazine is of a single-stack design, holding 18 rounds of 9mm ammunition. While this is a lower capacity than the 20 or 25 rounds of most factory-made twin-stack designs, the simplicity of manufacture more than compensates for the reduced firepower. Let's face it—if 18 rounds of fully automatic fire cannot satisfy your requirements, you need a bazooka, not a machine gun!

The tube must be cut to a length of 9", then cleaned and dried. A copy of the magazine template (Figure AA) should be made and, after being cut out carefully, glued to the side of the tube. The only score line needed is the curved section at the top of the template. Now the point of a punch is placed in the center of the 16 crossed holes and hit with a hammer. This will mark the positions of the cartridge counting holes ready for drilling. The

positions of the two base plate holes at the bottom of the template are also marked by the same method. The template is removed and the marked out section at the top of the magazine tube can be removed with a saw and a round or half round file.

A slot is now cut into the rear of the tube, 7 mm deep and as wide as the tube walls will allow. A 5 mm-diameter drill is used to make 16 viewing holes in the position marked earlier. The holes can be drilled through one side only or through both sides of the tube. Alternatively, the holes can be ignored completely, though they are very useful for quick observation as to whether the magazine is full, empty, or anywhere in between. The two base plate holes are drilled through both sides of the tube with a 3 mm bit. Drilling the viewing holes will create a series of burrs on the inside of the tube, and these must be removed. A flat file is inserted inside the tube and used to remove any burrs, so that the inside of the tube is perfectly smooth.

The magazine lips, which hold the cartridges inside the magazine, can now be formed to shape. Before this can be done, a simple forming block must be made (Photo 46), around which the lips are bent. The forming block is made from a 10" length of 1 x 1/2" flat steel bar. One end of this bar must be filed to the contours shown in Figure BB. The simplest way of doing this is to secure a large flat file to

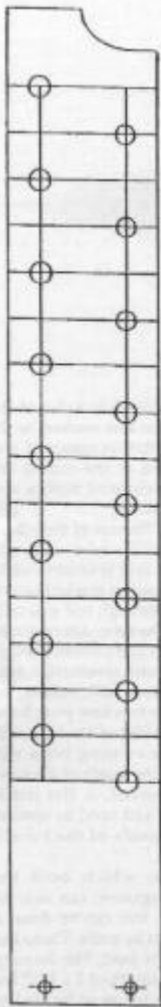

FIGURE AA
MAGAZINE TEMPLATE

REAR SLOT



PHOTO 48: The magazine tube with all holes drilled, shown alongside the form block and spring pins.

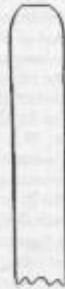

FIGURE BB
END VIEW OF FORM BLOCK (END OF BLOCK MUST BE SHAPED AS CLOSELY AS POSSIBLE TO THE CONTOUR SHOWN HERE)

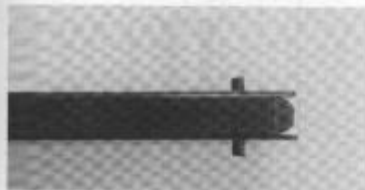

PHOTO 47: Rear view of magazine with block held in position with spring pin.



PHOTO 48: Magazine lips after forming.

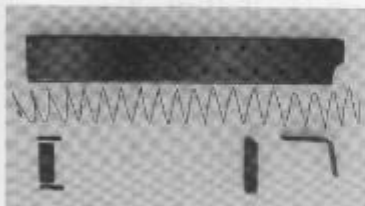

PHOTO 49: The magazine disassembled. The spring, follower, stop, base plate, and pins are shown in their respective positions.

a workbench and scrape the block across the file. This allows far more freedom of movement to file the curvature of the block than having it clamped stationary in a vise.

Once the block contour matches the drawing as closely as possible, the block is inserted inside the tube. It is positioned against the back wall of the tube with the formed end about 1 mm below the top of the

lips. The block is secured in this position by inserting a length of 7 mm-diameter bar into the gap between the block and the inside front of the tube. This should hold the block securely enough in position to allow a 5 mm-diameter hole to be drilled through the first viewing hole and all the way through the block. Now a 5 mm-diameter spring pin is tapped into the hole, and the round steel bar inserted earlier is removed. The spring pin is now holding the block securely inside the magazine tube (Photo 47), and we can proceed to the forming of the lips.

The assembly is clamped firmly in a vise so that only the top inch or so of the tube is visible above the vise jaws. A flat-ended punch, such as a short length of steel rod and a hammer, is required. The punch is placed against the lip along its top edge and tapped with the hammer while being moved back and forth along the length of the lip. After the lip is bent to the contour of the block, the same procedure can be carried out on the opposite lip. With the lips formed to shape (Photo 48), the spring pin and block are removed. If available, a micrometer is inserted into the top of the tube to measure the distance between the lips, which should be 9 mm across. If the gap is less than this, the block must be inserted back into the tube and its bottom end tapped with a hammer. This will drive the block upward and push the lips slowly apart, thus increasing the gap. The magazine tube is now finished, and the internal parts can be made and fitted.

There are three parts to make, all of which are quick and simple: the magazine spring, the follower, and the base plate. They will be constructed in the order in which they are inserted into the magazine (Photo 49).

The first part is the follower, so called because it sits over the magazine spring and follows the stack of cartridges. This is made by simply bending a 2 1/2" length of 1/2" x 16-gauge steel strip to the shape shown in Figure CC. A line is scored 1 1/2" in from one end of the steel strip. The 1 1/2" marked out section is placed in a vise so the vise jaws touch the score line. The 1" protruding section is tapped with a

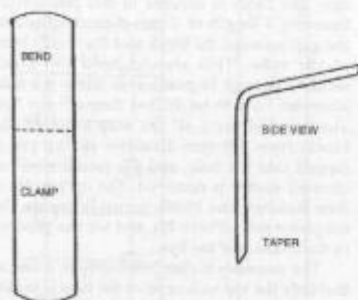

FIGURE CC
FOLLOWER CONTOURS

hammer until the follower matches the drawing. The sides of the follower may need to be filed slightly to allow it to slide freely into the magazine.

The sharp corners are rounded off at both ends of the follower, and then a slight taper is filed onto the end of the follower's longer leg. The follower can now be inserted into the magazine; it can only fit one way—short leg first. The magazine spring can be made next, but first a simple mandrel must be assembled to wind the spring around (Figure DD). Three steel rods, 14" long and 8 mm in diameter, are required. The rods must be cleaned and then stacked horizontally, one on top of the other, in a vise. Several inches of the rods should protrude from each side of the jaws, and the ends of the three rods must be level with each other. One end of the rod assembly is heated with a gas torch for a length of about 1". The rods should be glowing bright red, and then a self-fluxing brazing rod is applied to the areas to be joined. These areas should be brazed for a length of an inch or so to ensure a strong joint. The opposite end of the rods can now be brazed together in exactly the same way. The mandrel is left in the vise until the rods have cooled completely. The brazed areas are cleaned up with a file if necessary to remove

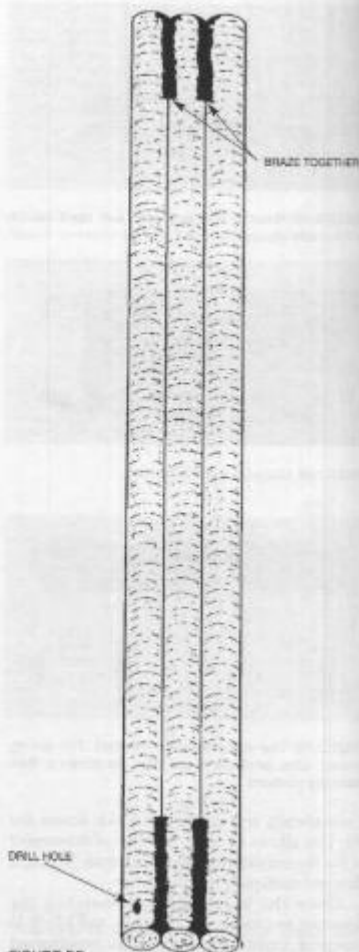

FIGURE DD
MAGAZINE SPRING
MANDREL



FIGURE EE
WIRE WOUND
AROUND MANDREL

KNOT



PHOTO 50: The magazine spring winding mandrel, made from three rods brazed together.

any rough spots. Silver solder could also be used to join the rods together perfectly well, but braze has better filling properties for the kind of wide joints created by the shape of the rods. Self-fluxing brazing rods eliminate the need to use any flux, since they are already coated with flux. This makes brazing a foolproof procedure.

Now a 1- to 1.5 mm hole is drilled through one end of the mandrel to allow the insertion of the spring steel wire. The magazine spring can now be wound from 20-gauge piano wire. Nothing heavier than 20-gauge should be used, as it would make the magazine difficult to load. A 6' length of wire is enough for winding the spring. The end of the wire is inserted through the mandrel's hole and knotted to prevent the wire from pulling out. To wind the spring, the end of the wire can be stood on and the mandrel pulled up until the wire is taut, or, alternatively, the end of the wire can be tied to a stationary object such as a vise, door handle, or drain pipe, and the mandrel can be held at an angle with both hands and turned (Figure EE). A gap of no less than 15 mm must exist between each coil of the spring. As with the coil mainspring, the gap can be adjusted by altering the angle of the wire while winding the spring. When tension on the wire is released, the coils will partially unwind and the spring will be triangular in shape. The knot of wire and any surplus unwound wire are snapped, and the spring is slid off the mandrel. The spring must now be bent back into its original rectangular shape, using the fingers to squeeze the sides of



PHOTO 51: The magazine assembled and ready for the stop to be fitted.

each coil back into shape. Though difficult to explain in words, this is a straightforward procedure, and it will become self-explanatory when you see the spring. When a round spring such as the main spring is wound, it also unwinds but it still remains round, albeit a larger diameter. However, the rectangular spring does not remain rectangular when tension on the wire is released. Although this is an unavoidable nuisance, it is quickly rectified. After the coils are bent back into shape, the spring is slid back over the mandrel and fully compressed several times. As with the coil main spring, the magazine spring will shrink in length from 14" to approximately 11", though this is only a rough guide. As long as the spring is 1" to 2" longer than the magazine tube, it is the correct length. Now the spring is slid into the magazine behind the follower.

Next the base plate is made and held in position with two spring pins, 3 mm in diameter.

The plate is a 30 mm length of 1/2" x 16-gauge steel strip—the same material used for the follower. The steel strip is cut to length and held in position in the bottom of the magazine. The two spring pins are now inserted to hold the base plate in position. It is far easier to tap the pins just into one side of the magazine before inserting the base plate; this leaves both hands free—one to hold the plate in position and the other to hold the hammer.

The last part of the magazine to make is the stop. This has two purposes: it stops the magazine from being pushed too far into the

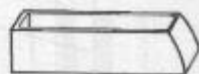

MAGAZINE STOP

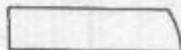

SIDE VIEW
END OF STOP FILED INTO A CURVE

FIGURE FF
MAGAZINE STOP CONTOURS

gun, and it hooks onto the magazine catch to hold the magazine in position.

The stop is simply a 9 mm-thick slice of the same 40 x 20 mm tube as was used to make the grip and well. A set square is used to mark a straight line across the tubing to ensure both sides of the stop are square. After it's cut out, the stop is slid over a file to make sure both ends are perfectly flat and smooth. A curved taper is now filed onto one end of the stop to allow the catch to slide over it. The contour of the stop's taper is shown Figure FF. The stop should now be about 9 mm thick with a taper filed onto one end. The stop is slid over the top of the magazine with the tapered end positioned at the rear. The stop is positioned directly over the sixth viewing hole from the top of the magazine, and the magazine is inserted into the machine gun.

The release catch should slide over the tapered end of the stop and snap firmly into place, locking the magazine into position (Photo 52). The stop may need to be adjusted or filed slightly to reduce its thickness to allow the catch to fall into position. The stop will be silver-soldered in place eventually, but it must remain movable for now until after test-firing has been carried out, to allow for any adjustments.

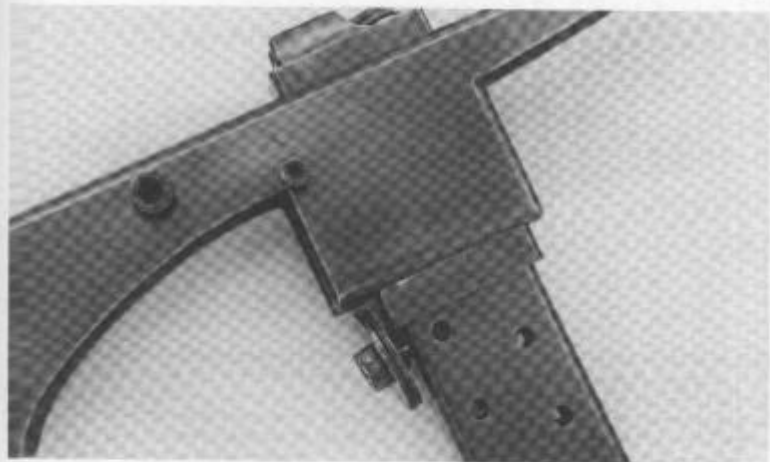

PHOTO 52: The magazine fitted. The magazine catch should hold the magazine firmly in position.

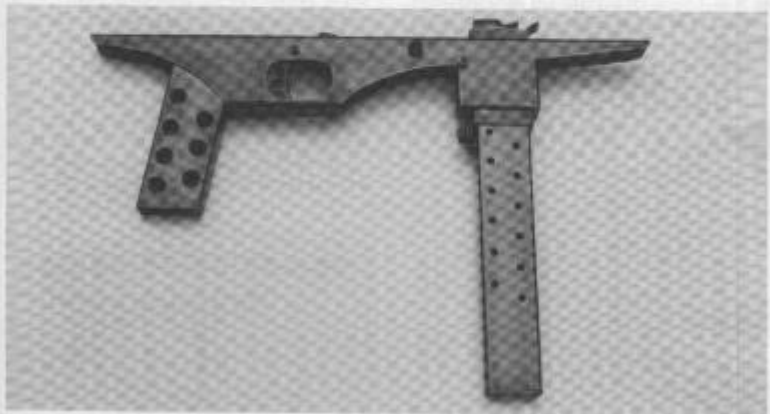
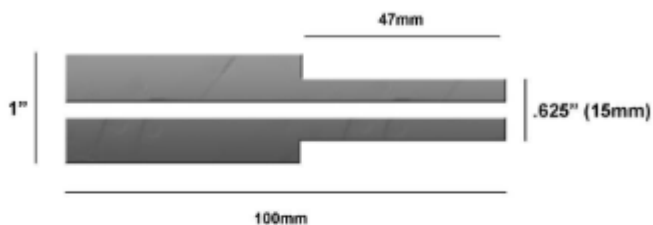

PHOTO 53: The fully assembled lower receiver with all internal parts fitted.

Bolt

Turn on a lathe from 1" mild steel round bar



Bore a 3mm dia hole through center

Harden bolt face using Kasenit

Striker assembly

Firing pin: 3mm silver steel rod - round off tip

Either weld at rear or retain in a blind hole

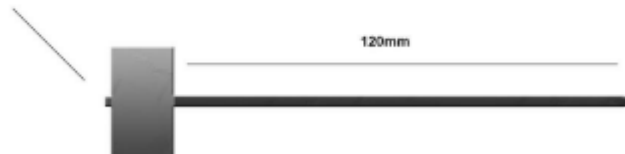

1" mild steel round bar, 15mm long

- Firing pin can be of a larger OD and necked down through a smaller ID hole in breech face end.

Bolt assembled

47mm long steel plate or 1" dia (5mm wall) steel tube cut in half and welded in place to reduce wear on bolt face



Cut sear relief ramp on underside of bolt

Recoil / return spring contact plate

53mm



1/4" mild steel plate - weld in place

Front

Cocking handle

(8mm steel bar, 45mm long. Tap into a blind hole)

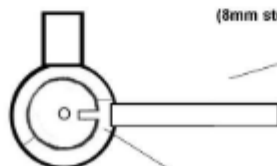

Cut a 5mm deep slot on right side of smaller dia section for ejector

Barrel & collar



STEH feed cone

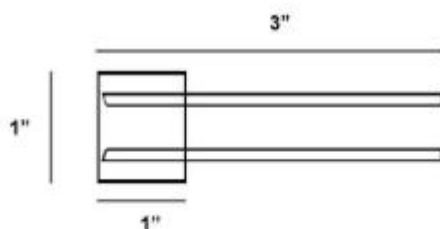

Cut a feed cone / bevel into the front of chamber using a 16mm+ bit

Striker spring

4 3/4" (120mm)

Unmodified purchased compression spring

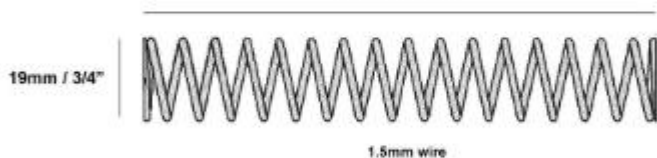

Recoil / bolt return spring

6"

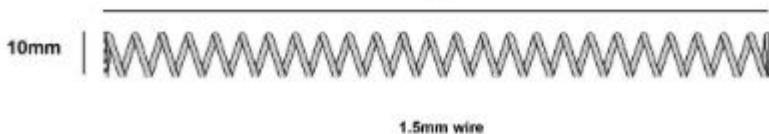

Fabricate a rear plug from a 1/2" length of 1" bar. Retain spring assembly via a 45mm long M8 bolt + nut inserted through a hole drilled vertically through spring holder, plug and receiver.

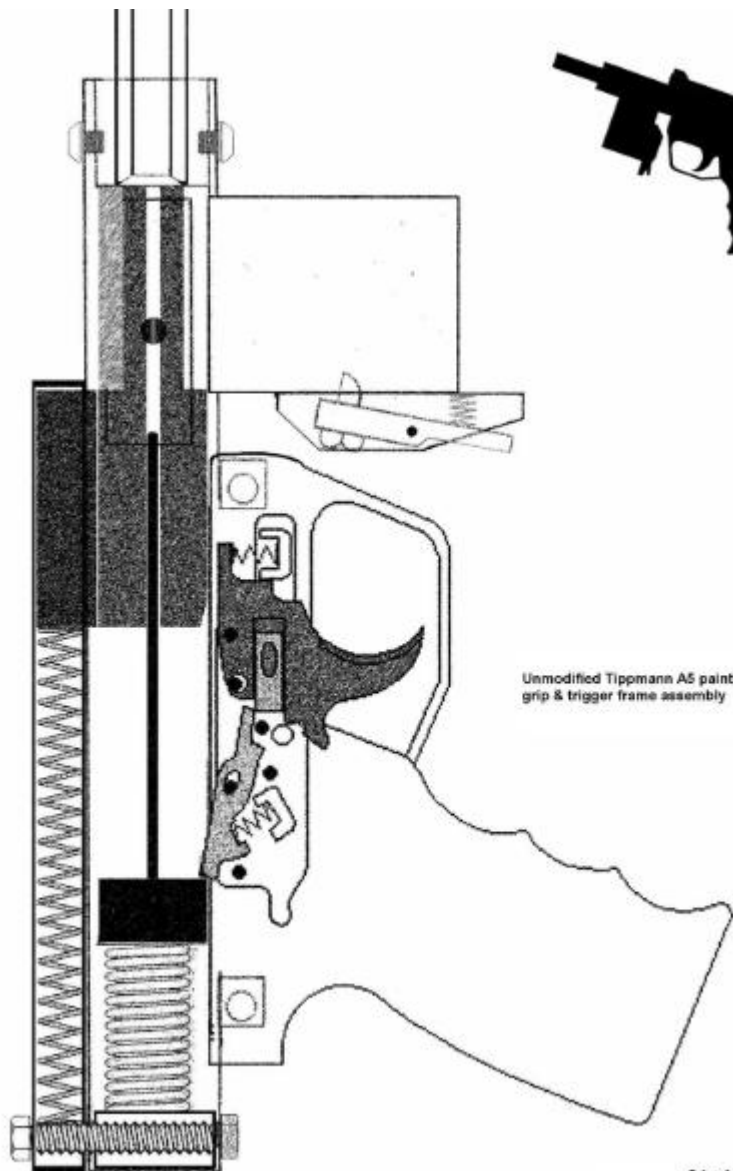

Unmodified Tippmann A5 paintball marker
grip & trigger frame assembly

2 inches

Print on 8.5x11 US letter paper

2. 9mm SMG

Here's an excerpt of Expedient Homemade Firearms The 9mm BSP Machine Gun by P.A. Luty. See it for measurements.

The 9mm 'BSP' Sub - Machine Gun

The following design drawings illustrate the construction of a 9mm sub-machine gun utilizing off the shelf 'British Standard Pipe' (BSP) Fittings. BSP fittings, commonly known as 'Malleable Iron Fittings', are readily available from most good trade plumbing outlets. Because this BSP machine gun design uses some of the same components seen in *'Expedient Homemade Firearms'* Volume I, I have not discussed their manufacture again here, for fear of boring the reader, and myself. The magazine and magazine well being two examples. The following design is offered on the understanding that the

reader is already familiar with the firearm construction methods shown in my previous *'Expedient Homemade Firearms'* books. I will leave the reader to decide whether this design is good, bad, or somewhere in between!

MATERIALS REQUIRED

1. 1-1/4" BSP tube x 12 1/2" length.
2. 2.5mm steel sheet (x2) 9-3/4" length.
3. 40x20 x 2.5mm tube.
4. 34.93x 15.88 x 1.6mm tube
5. 20g x 3/8" spring steel.
6. 1/8" steel plate.
7. 1/4" " "
8. 1/4" " "
9. 5/8"x 14g steel sheet.
10. 6mm studding connectors x 2.
11. 6mm cap screws x 4.
12. Dowel pins, 4 & 6 mm dia.
13. 1" x 1/8" round tube.
14. 35mm dia' rubber stock.
15. 1 1/4" x 1/2" BSP Reducer.
16. 1/2" BSP Socket.
17. 1/2" BSP Lock Nut.
18. 1/2" BSP Threaded Tube.
19. 1 1/4" BSP Cap.
20. 15.88 x 3. 25mm Hydraulic tube.
21. Assorted nuts and bolt.

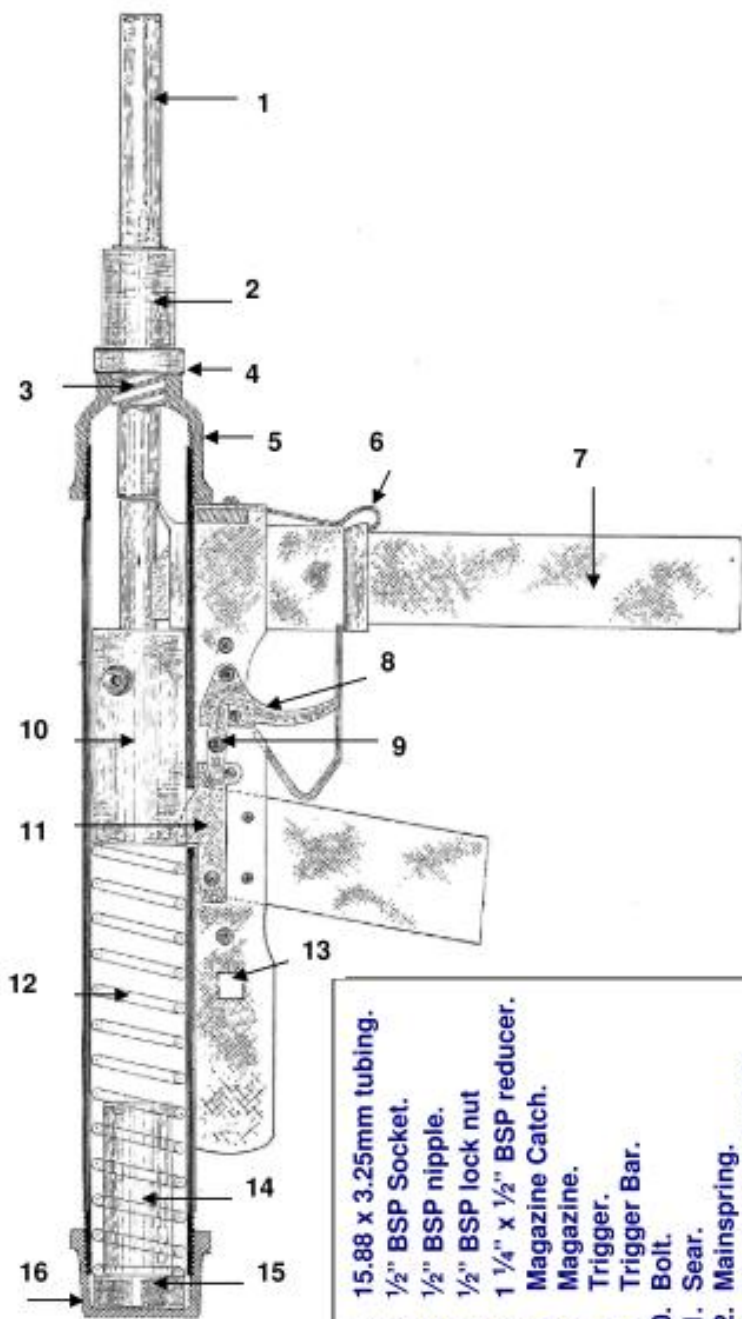

1. 15.88 x 3.25mm tubing.
2. 1/2" BSP Socket.
3. 1/2" BSP nipple.
4. 1/2" BSP lock nut
5. 1 1/4" x 1/2" BSP reducer.
6. Magazine Catch.
7. Magazine.
8. Trigger.
9. Trigger Bar.
10. Bolt.
11. Sear.
12. Mainspring.
13. Stock anchor point.
14. 1" Diameter x 1/8" tube.
15. Rubber buffer.
16. 1 1/4" BSP pipe Cap.

TEMPLATES

(Internal Components. Hole Diameters Arrowed)

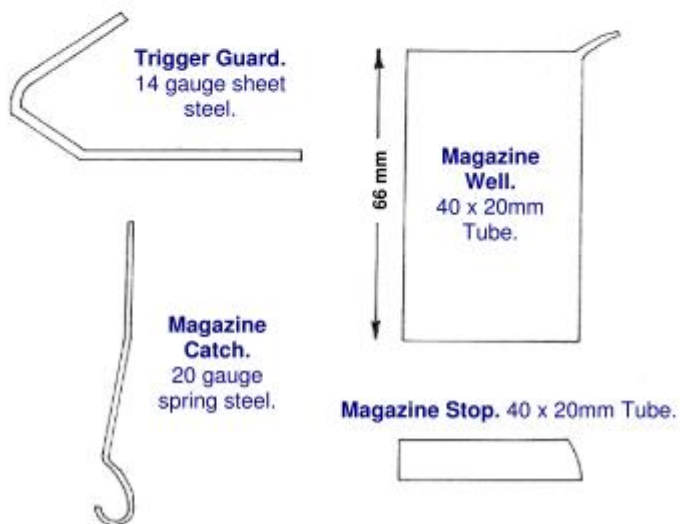
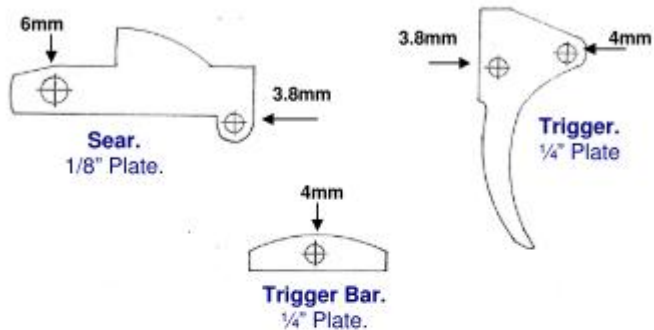

LOWER RECEIVER TEMPLATE

(Hole diameters shown in millimetres)

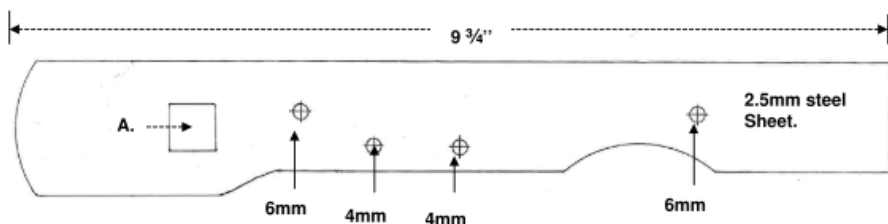

The lower receiver is composed of two receiver side-plates, each being $9\frac{3}{4}$ " in length. Each plate is identical. Each side-plate is cut from a length of 2.5mm thick steel sheet to the shape of the above template. The square recess shown in figure 'A' is the anchor point for the shoulder stock. This measures $\frac{1}{2}$ " square.

Note: If the template is not $9\frac{3}{4}$ " in length when printed, it may be enlarged using a photocopier until the necessary length is achieved.

LOWER RECEIVER ASSEMBLY

To create the lower receiver assembly, the two receiver side-plates are joined together by spacing them between two 6mm studding connectors, (A and B). Four dome head cap screws are then screwed into the connectors and thoroughly tightened, effectively holding the assembly together. The two connectors must be *exactly* 20mm in length.

As bought, 6mm connectors are usually this exact length, but if they are not, they may be trimmed on a lathe until the required length is achieved.

A section of steel plate measuring 20 x 20mm is now silver soldered between the two side-plates in the position shown at 'C' below. The plate should be $\frac{1}{4}$ " thick. A gap of 2mm should now exist between the plate and the end of the receiver.

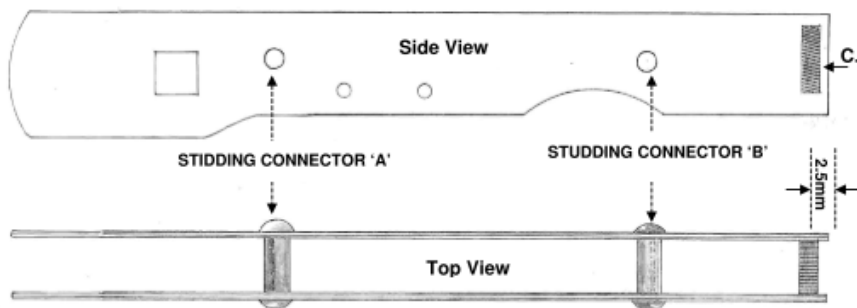

LOWER RECEIVER: WELL AND GUARD FITTED

The magazine well is inserted into the receiver and welded in place along points 'A' and 'B'.
Note: Do not weld along opposite side of point 'B'. It must be ensured before welding that the top edge of the well is 7mm above the top edge of the receiver.

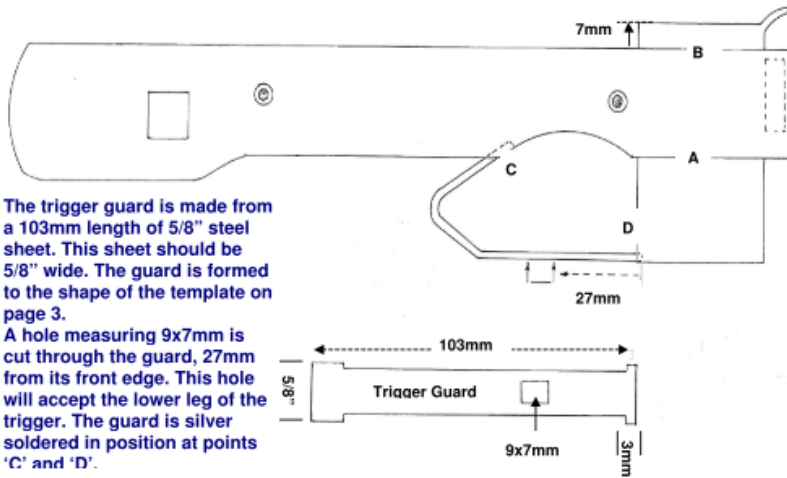

The trigger guard is made from a 103mm length of 5/8" steel sheet. This sheet should be 5/8" wide. The guard is formed to the shape of the template on page 3.

A hole measuring 9x7mm is cut through the guard, 27mm from its front edge. This hole will accept the lower leg of the trigger. The guard is silver soldered in position at points 'C' and 'D'.

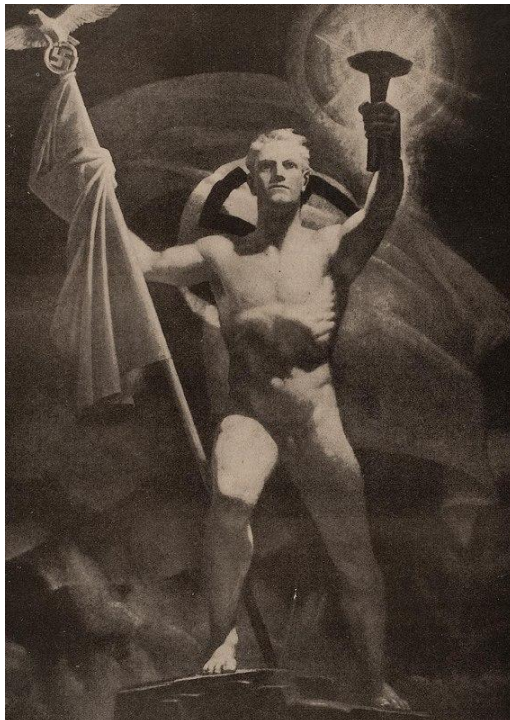

PISTOL GRIP

The grip is the next part to make.

It is made from a 112mm length of 40 x 20mm tubing.

A 5.8mm diameter hole is drilled through the grip in the position shown in the accompanying grip template.

Before the grip is fixed to the receiver the sear must be made and fitted. See *page 8*.



SEAR CONSTRUCTION

The sear is cut from a section of 1/8" thick steel plate. See templates, page 3.

A 4mm diameter dowel pin is tapped into the sears 3.8mm hole.

The pin should protrude 8mm from the sears right side when fitted.

The sear is made from mild steel and should be case hardened after final shaping.

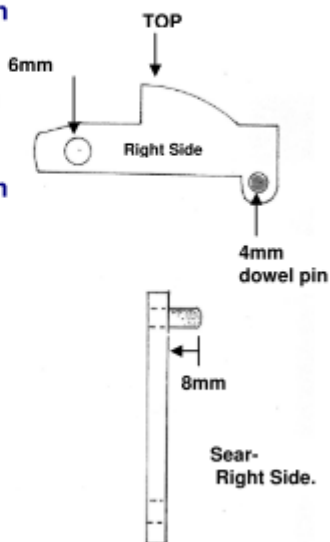

TRIGGER

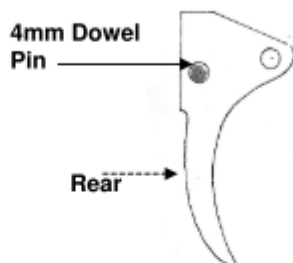

Pin must protrude 6mm from each side of trigger.

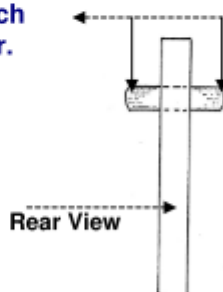

The trigger is made from a section of $\frac{1}{4}$ " thick steel plate. A 4mm diameter dowel pin (a spring pin could be used as a substitute) is tapped into the 3.8mm hole. The pin must protrude 6mm from each side of the trigger when fitted.

FITTING THE SEAR

Before the sear is fitted, a slot is cut through the rear and front of the grip wall. The slot is 15mm deep and 4mm wide. The sear is inserted into this slot and retained with a 6mm diameter dowel pin. This pin should be 20mm in length.

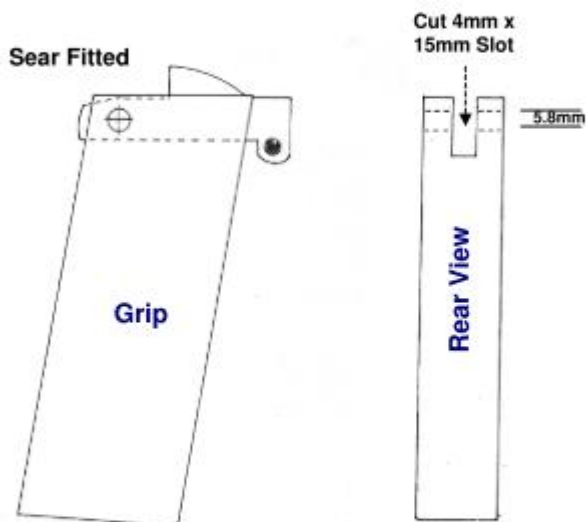

Spring Fitted

The sear spring is formed from 20g spring wire to the shape illustrated opposite. It should have between four and six coils.

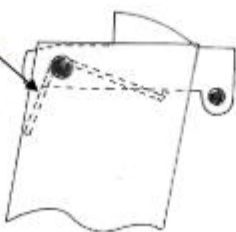

Sear Spring

GRIP ASSEMBLY FITTED

The grip and sear assembly is inserted into the receiver and retained with two dowel pins.

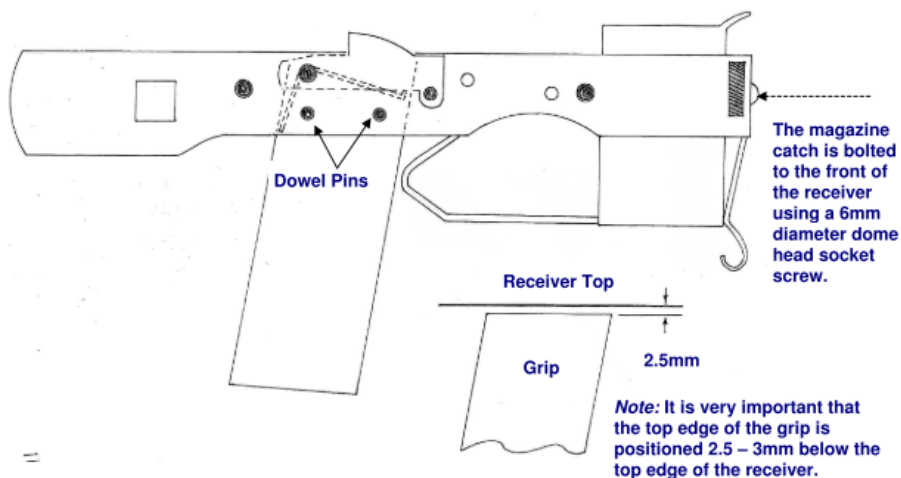

FULLY ASSEMBLED LOWER RECEIVER

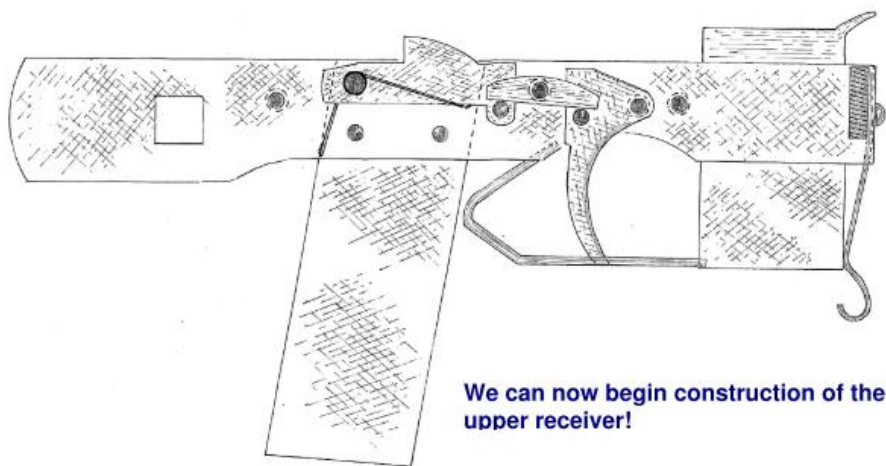
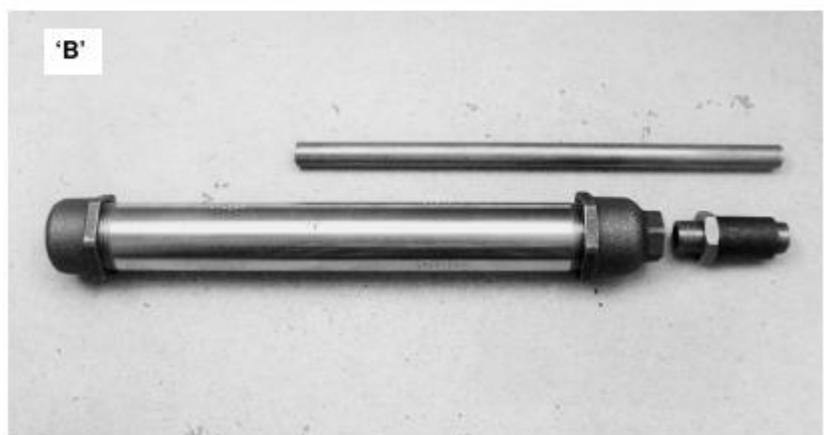

PHOTO OF UPPER RECEIVER COMPONENTS

The upper receiver assembly consists of a 1¼" BSP tube (screwed at both ends) and fitted with a Cap and Reducer, as photo 'A' below illustrates. Photo 'B' shows the reducer and cap screwed onto the receiver tube and the barrel assembly ready for fitting.



UPPER RECEIVER TEMPLATE

The upper receiver template must be enlarged using a photocopier until it is 12 ½" in length. Once enlarged, the template is glued around the 1 ¼" BSP upper receiver tube. The recesses for the ejection port, magazine well (EP&MW), bolt handle, and sear, can then be marked onto the receiver tube.

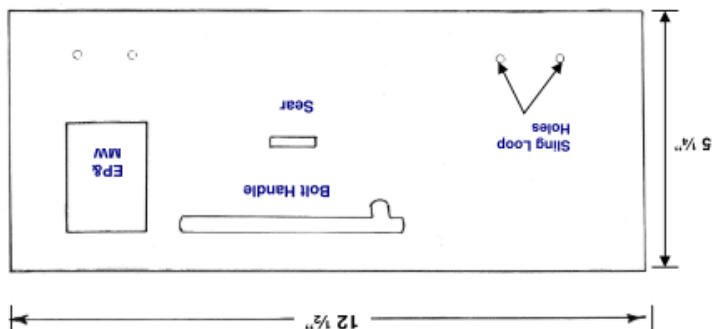

PHOTO OF TEMPLATE ATTACHED TO UPPER RECEIVER TUBE

The template is attached to the upper receiver tube to allow the necessary recesses to be marked onto the tube.



UPPER RECEIVER

Thread length: 1-1/8"

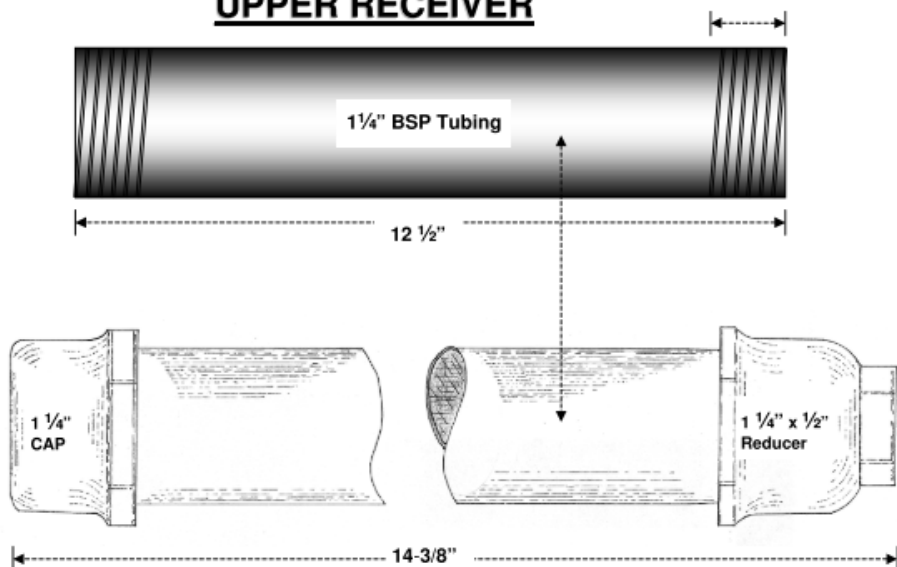

BARREL ASSEMBLED

(The barrel is assembled from 'BSP' pipe fittings)

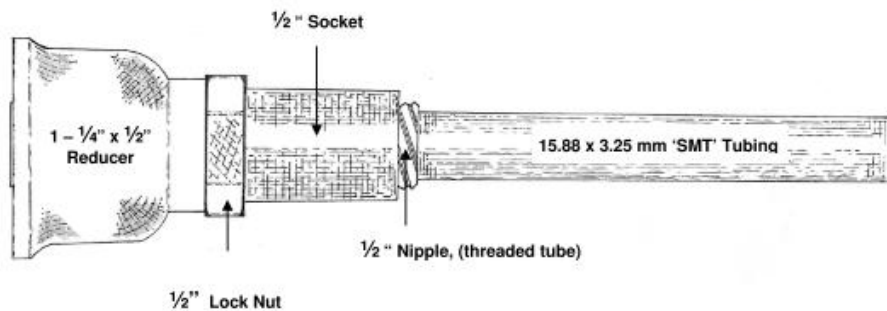
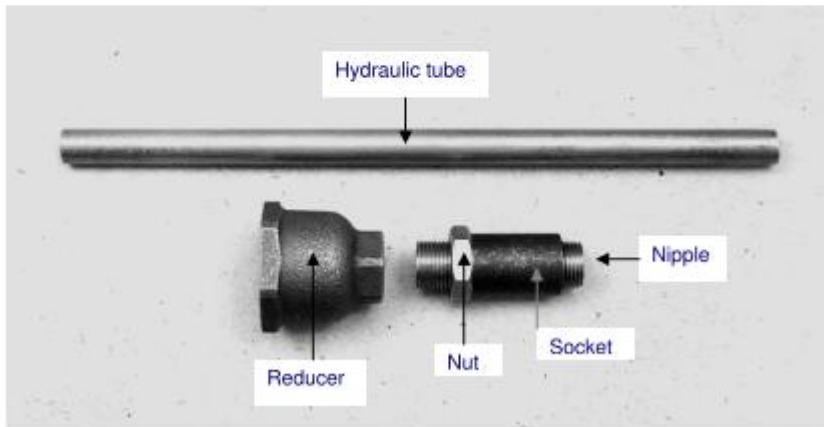

PHOTO OF BARREL COMPONENTS

The barrel is assembled from a length of 15.88 x 3.25mm hydraulic tubing, a 1/4" BSP Reducer, 1/2" BSP Lock nut, 1/2" BSP Socket, and a 1/2" BSP Nipple, (threaded tube).



BOLT ASSEMBLY

The bolt is machined to the following dimensions from a suitable section of round steel stock.

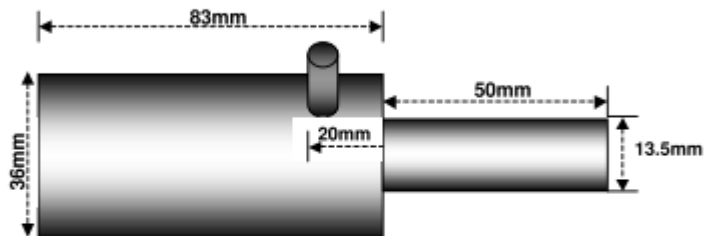

BUFFER AND SPRING GUIDE

The buffer is made from a section of hard rubber stock to the following dimensions.

The spring guide is nothing more than a length of 1" diameter tubing.

The tubing should have a wall thickness of 1/8".

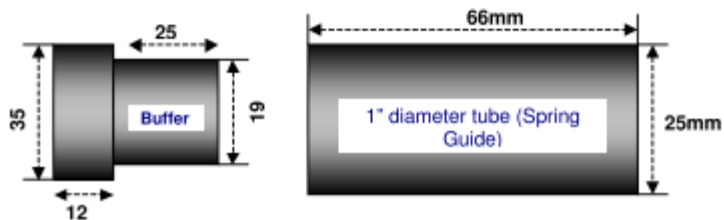

ALTERNATIVE BOLT CONSTRUCTION METHOD

An alternative to machining the SMG bolt would be to assemble it from the components illustrated below.

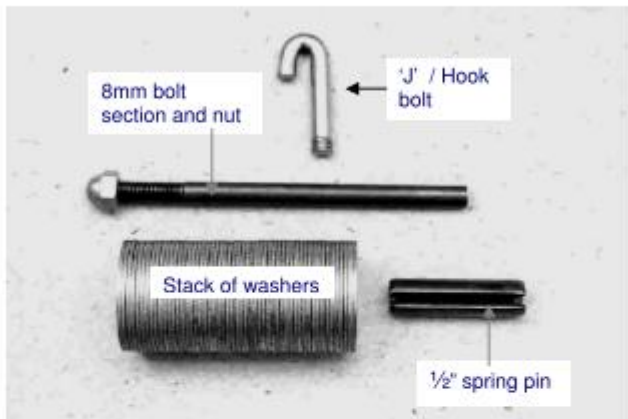

The components are fitted to the 8mm bolt section as shown below.

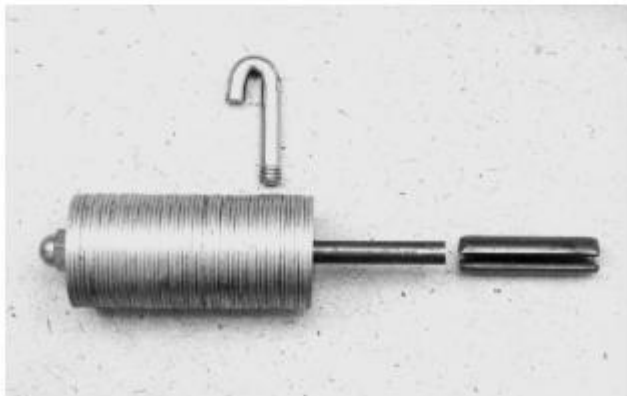

The ½" spring pin is two inches in length and is silver soldered to the end of an 8mm diameter high tensile bolt. The end of the bolt section being fitted with the firing pin prior to this.

A stack of 1 ½" diameter washers (with 8mm holes) are then inserted over the bolt section and retained with a nut.

Around 52 washers are necessary to provide the bolt with the required length and weight.

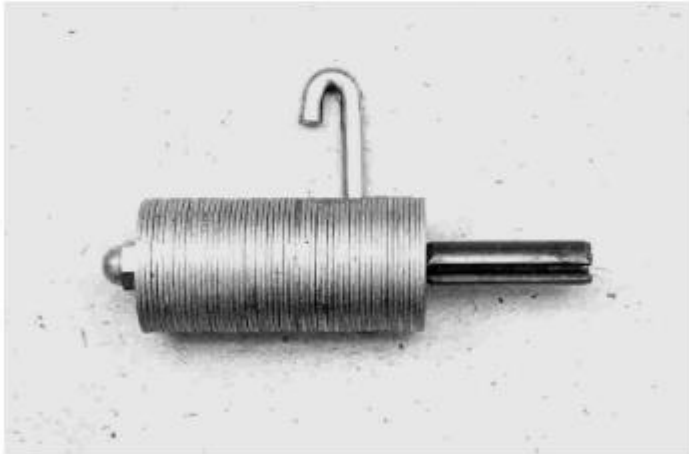

>Who, if not you?
>When, if not now?

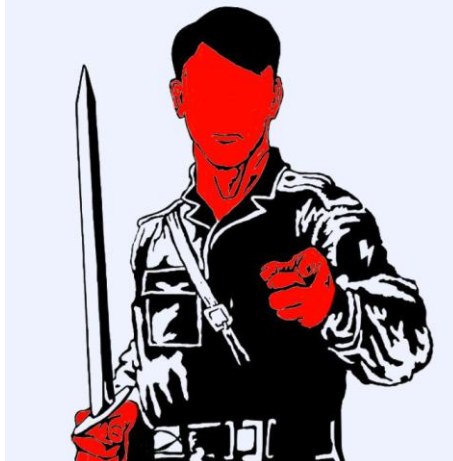

Drill two 2mm diameter holes through the Magazine body and cap to retain the cap in position.

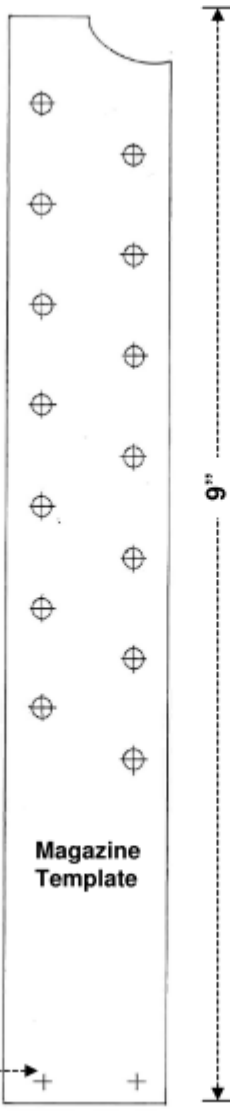

Magazine Template

The magazine body is 9" in length. If it is not this length when printed, the template should be enlarged using a photocopier until this measurement is achieved.
The template is attached to a length of 34.93 x 15.88mm tubing.

A 34.93 x 15.88mm plastic tube cap is used to seal off the bottom of the magazine.

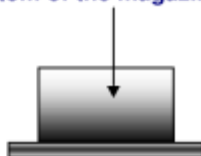

FITTING A SHOULDER STOCK

It is quite possible to construct a simple folding shoulder stock for the BSP machine gun using nothing more than a modified 3/8" ratchet spanner and a length of steel tubing!

The following pages illustrate how this is done.

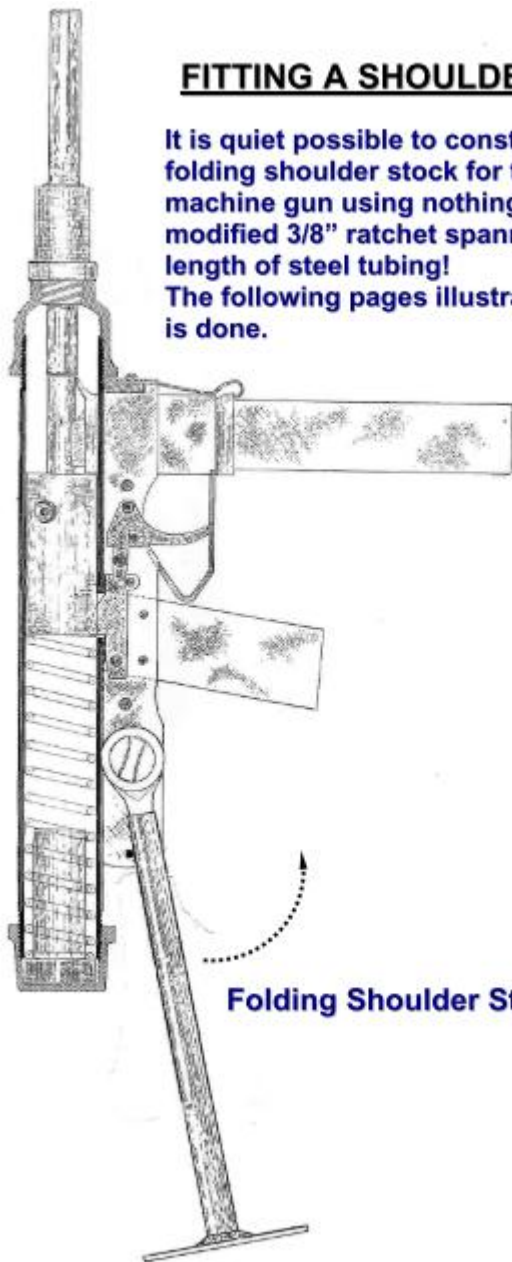

Folding Shoulder Stock.

PHOTO OF SHOULDER STOCK COMPONENTS

The shoulder stock is assembled from a 3/8" ratchet spanner, a length of 5/8" round tube, a section of 1/2" box tube, four washers, a cotter pin, and a length of 1" x 1/8" steel plate.

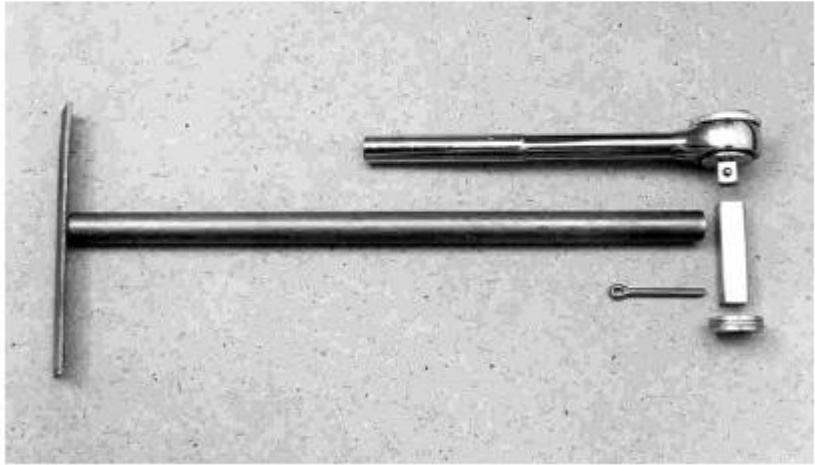

ASSEMBLING THE SHOULDER STOCK

MATERIALS REQUIRED

1. 3/8" ratchet spanner.
2. 5/8" x 16g steel tube.
3. 1/2" x 16g box section tube.
4. 1 1/4" washers x 3/4" hole.
5. Cotter pin x 1.

Insert tube onto ratchet and retain using high strength bearing adhesive.

3/8" Ratchet spanner.

The ratchet spanner is cut down and shortened until it has an overall length of around 4 – 5".



Slide washers onto tube.

A series of washers are placed over the 1/2" box section. These may consist of either four standard 'light' washers or two to three thick 'heavy' washers. Either way, the stack of washers must result in a combined length of 4 – 5mm.

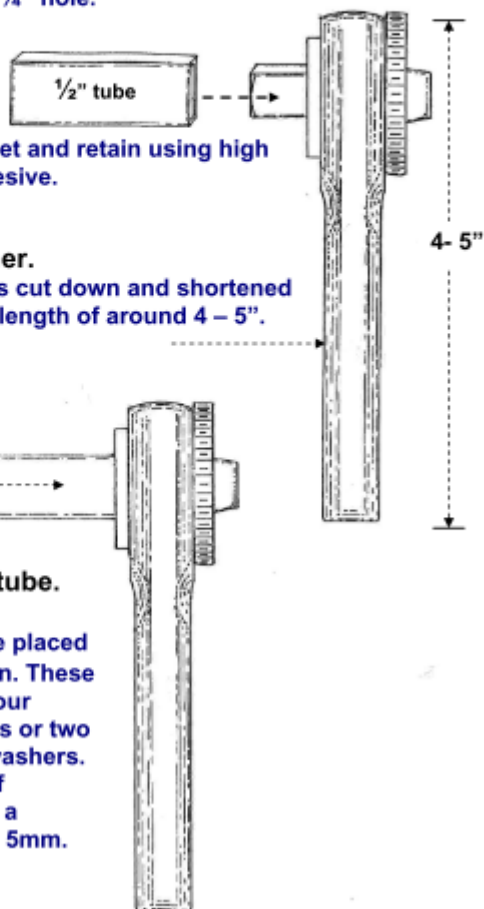

REAR VIEW OF WEAPON SHOWING
SHOULDER STOCK ATTACHED TO
RECEIVER

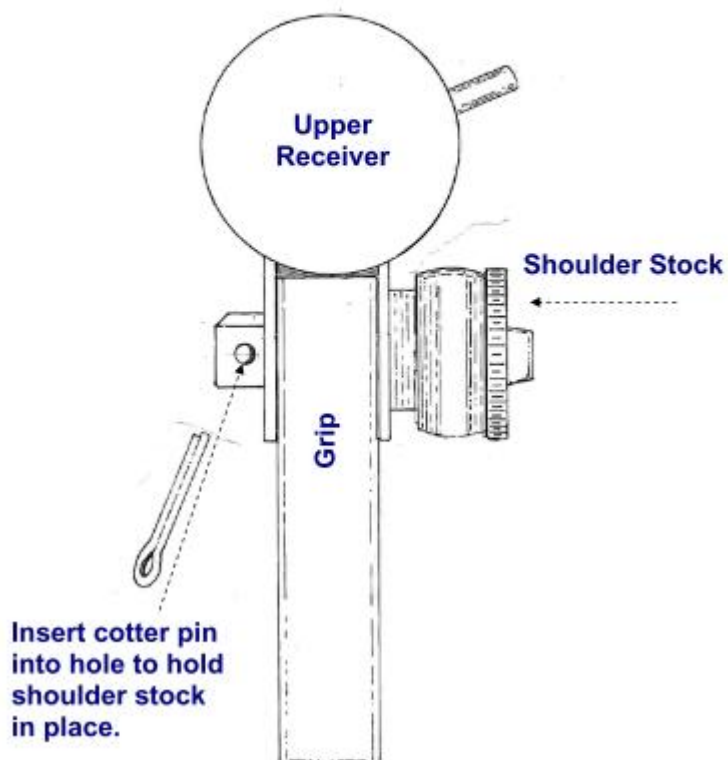

SHOULDER STOCK

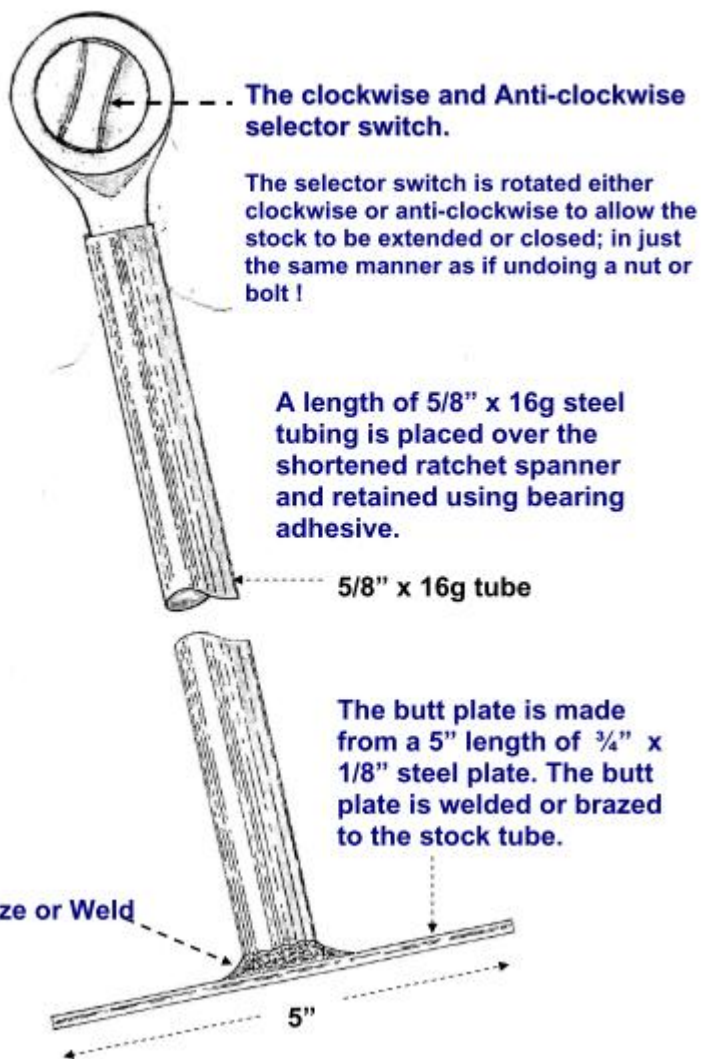

Construction notes:

1. Mainspring/ recoil spring; a suitable mainspring for the BSP machine gun can be acquired by stripping down a side lever grease applicator gun and removing the spring.

The spring illustrated below measures 216mm (8 1/2") in length and 30mm in diameter. The wire the spring is made from being 2mm in diameter.

This spring is almost perfect in dimensions for the BSP machine gun and was removed from the grease gun shown below. Spring sizes do vary depending on grease gun manufacturer.

2. Magazine; The magazine for the BSP machine gun is identical to that shown in my book *'Expedient Homemade Firearms' - The 9mm machine Gun*. See book for details.

3. Stock; The length of the shoulder stock can be adjusted to suit individual requirements by simply increasing or reducing the length of the stock tubing prior to final assembly.

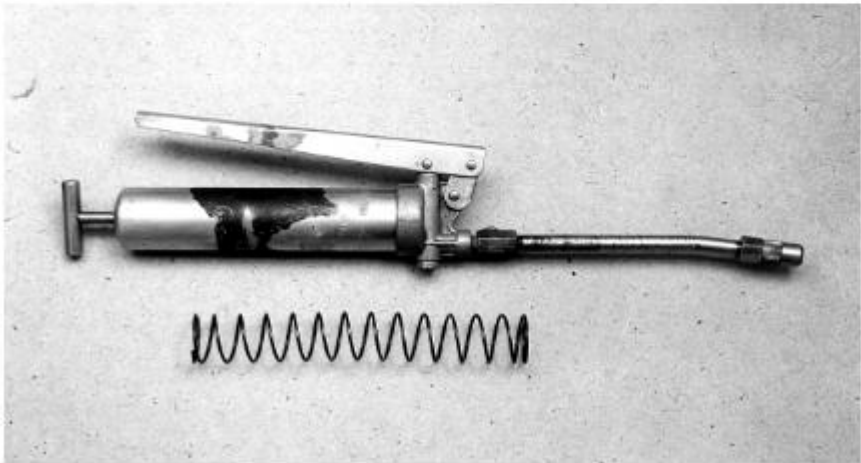

Side lever grease applicator and internal spring.

For other guides to building a DIY 9mm SMG see: *Expedient Homemade Firearms The 9mm Submachine Gun* by P.A. Luty, *Expedient Homemade Firearms The 9mm Machine Pistol* by P.A. Luty, *Expedient Homemade Firearms Volume II The .32/.380 Machine Pistol*, *Practical Scrap Metal Small Arms Volume 8 9mm Bullet Hose*, and *A Do it Yourself Submachine Gun* by Gerard Metral. The guide by Gerard Metral is highly recommended.

3. 12 Gauge Pump-Action Shotgun

The following guide is from Practical Scrap Metal Firearms Volume 20 Pump Action Shotgun by Professor Parabellum. See it for measurements. For an alternate shotgun design see Homemade Break-barrel Shotgun by Professor Parabellum.



The following 12 gauge pump-action shotgun design can be manufactured in the home environment without the use of a lathe or milling machine. The majority of its components are constructed from standard sizes of steel box section and round tubing, including the barrel. 12 gauge being a cartridge which produces relatively low chamber pressures allows the use of a simple bolt locking mechanism, in this instance a spring loaded lug which is keyed in or out of a hole in the thick-walled upper receiver via the rearward or forward motion of the action bar.

Magazines can be fabricated from rectangular tubing or the design adapted to accept commercially available shotgun magazines such as those offered for the Saiga-12. Additionally, cheap widely available surplus battle rifle magazines such as those made for the FAL, SLR, BAR or G3 can all be easily made to accept and feed 12 gauge shells by simply modifying the feed lips and front wall to allow the cartridges to sit higher and be stripped by the bolt.

Land Maintenance Tool

12 Gauge Detachable Magazine-Fed Repeater



Materials list:

- 38mm x 38mm (1 1/2" OD) x 3mm (.120) mild steel box section
- 30mm x 30mm x 2mm mild steel box section
- 30mm x 2mm (1" ID) mild steel round tube
- 25mm (1" OD) x 2.5mm (3/4" ID) seamless steel round tube
- 2mm thick, 20mm (3/4") wide steel strap
- 25mm (1") dia steel bar
- 30mm dia mild steel round or square bar
- 6mm (1/4") dia steel bar
- 10mm thick steel plate
- 6mm (1/4") thick steel plate
- 2" thick hardwood or plastic

All pages included should be printed out on 8.5 x 11 US letter paper. Each component template is drawn to scale and can be cut out and glued to their respective thickness of material or used as reference for measurements.

Make sure the ruler at the bottom left of each sheet is 2 inches in length. Alternatively, take a screen-shot and enlarge the plans using a computer program until the ruler is the correct length, then trace the parts needed onto a sheet of paper taped over your computer's screen.

For Academic Study Purposes only

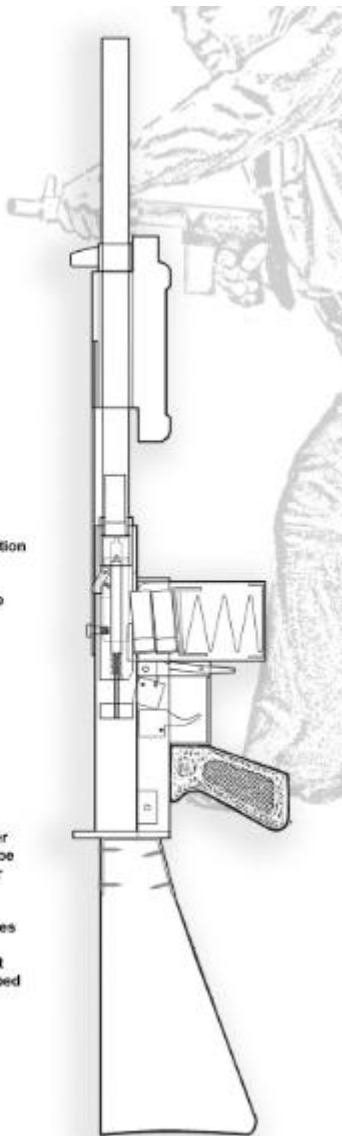

Upper receiver

(Bottom)

281mm long

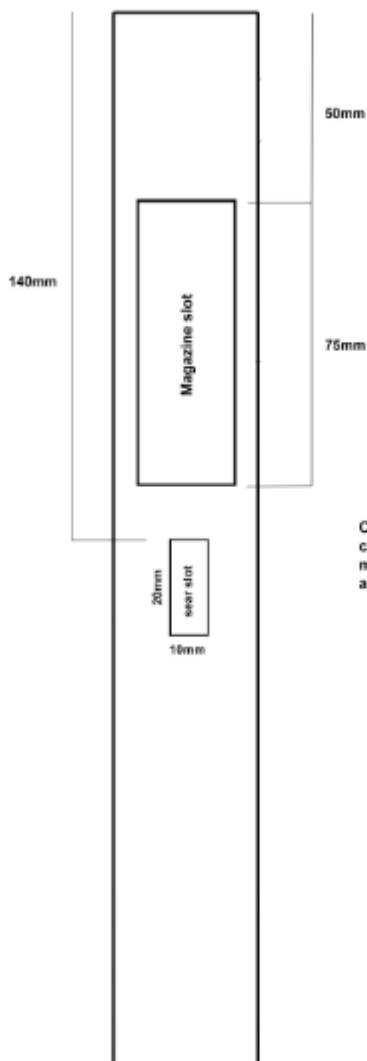

Cut out openings using a combination of chain-drilling holes around the inside of parts marked and slitting using a dremel fitting with a reinforced cut-off disc.

Mild steel square box section

38mm x 3mm wall

(1 1/2" x .120 wall)

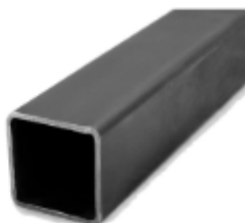

Upper receiver (Continued)

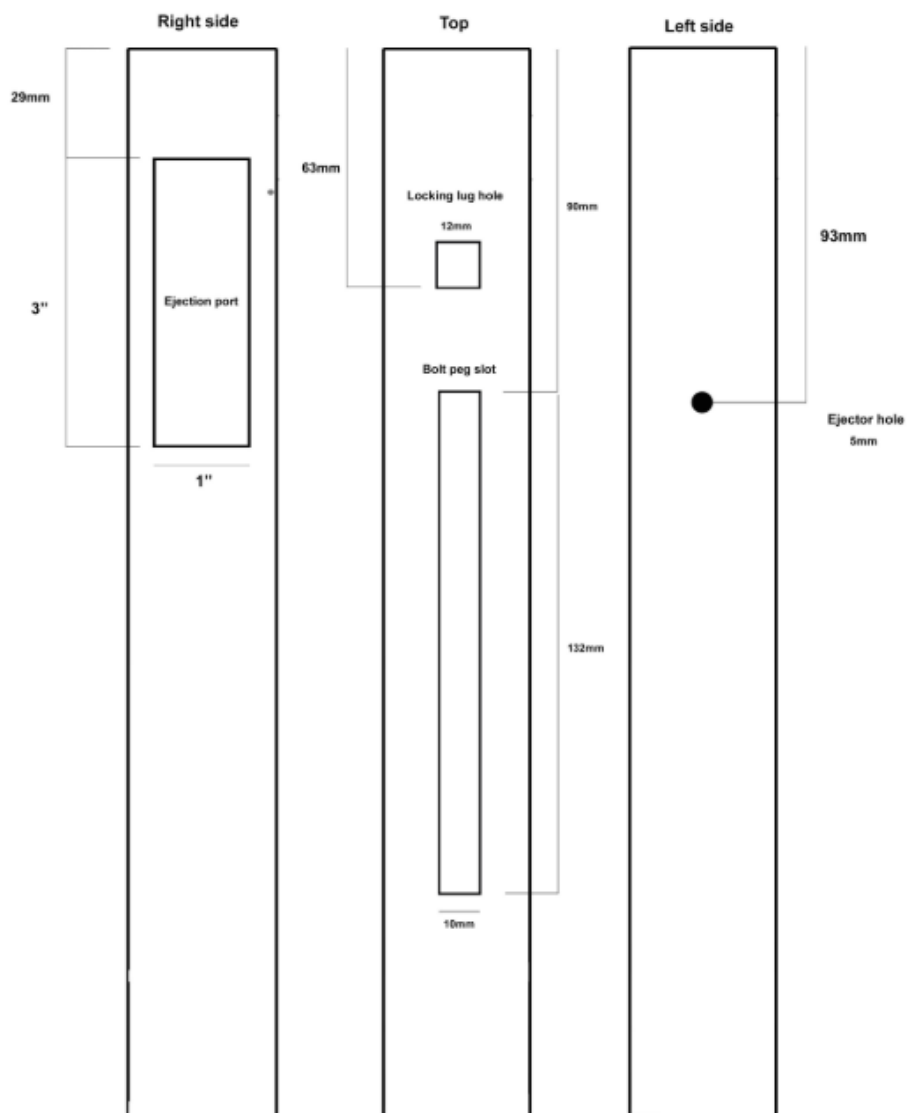

Mounting lugs

Can be made from solid blocks of 1" steel
or folded from 3mm thick sheet to match inner
dimensions of lower receiver

Drill holes while mounted in the correct
position with lower receiver to ensure
accurate alignment.
Take-down is achieved via two removable
30mm long 8mm diameter steel pins.

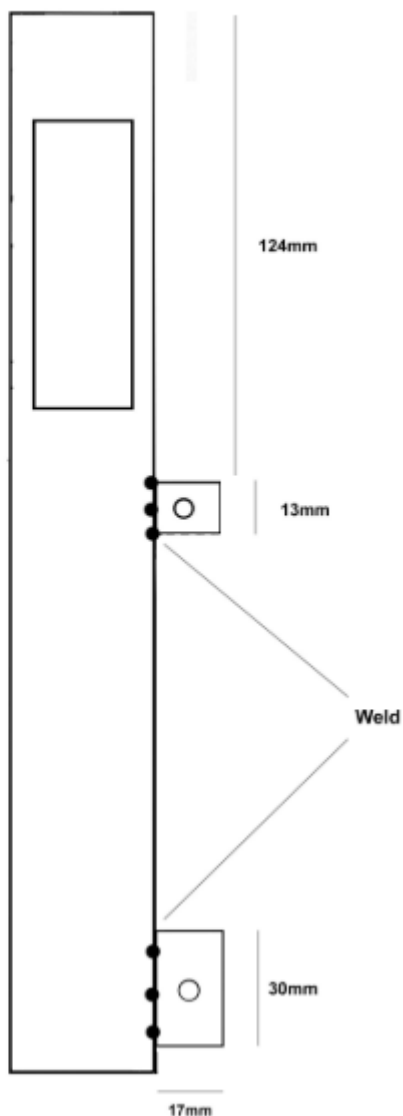

Lower receiver (Right side)

30mm x 30mm x 2mm thick wall
mild steel square box section tubing

236mm long

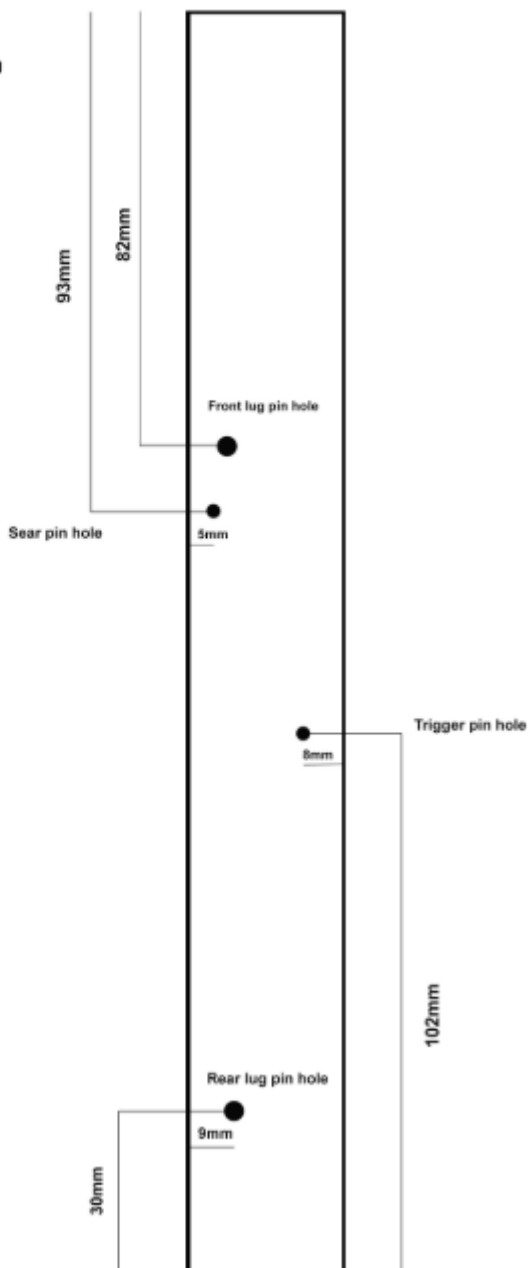

2 inches

Print on 8.5x11 US letter paper

**Lower receiver
(Bottom)**

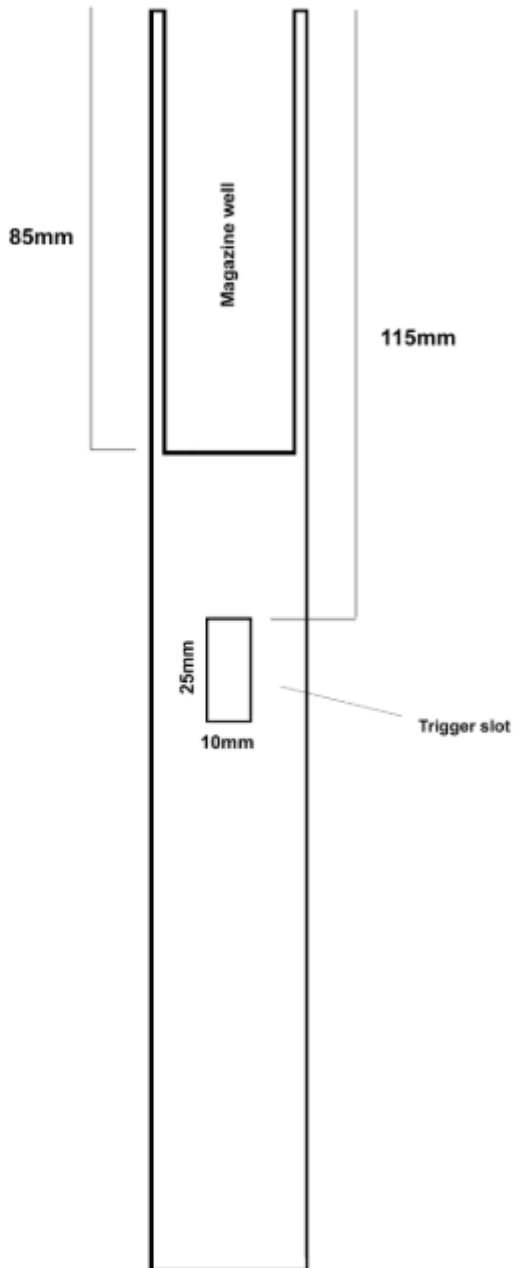

Lower receiver
(top)

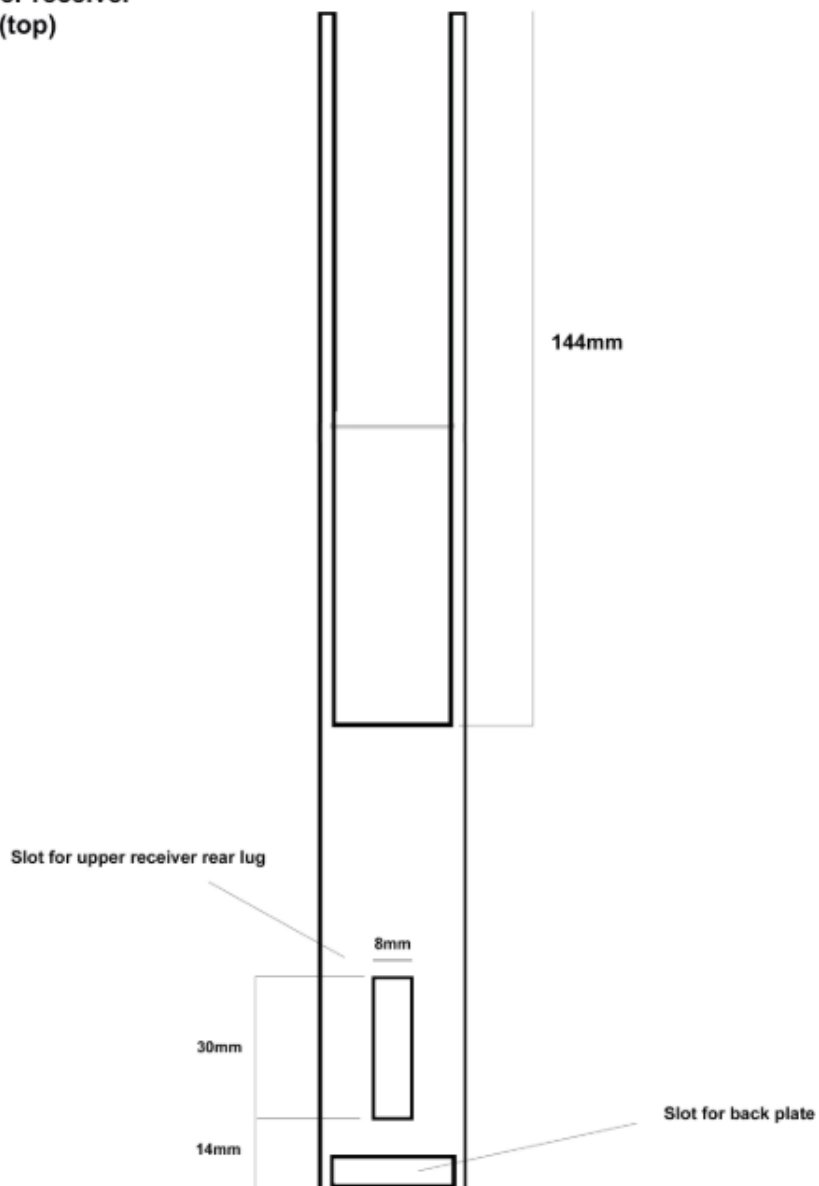

Magazine catch

1/4" thick steel or aluminum plate

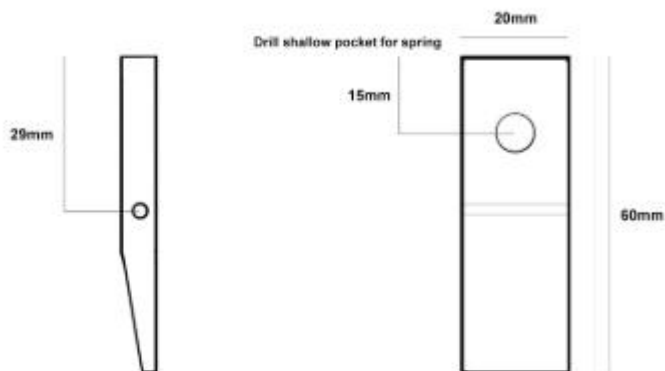

Catch housing

1" square tubing, 65mm long

Secure catch inside housing using a 1" long 3mm dia pin



Assembled



2 inches

Print on 8.5x11 US letter paper

Rear sight / lower receiver backplate

6mm (1/4") mild steel plate

Sight hole: 6mm

88mm

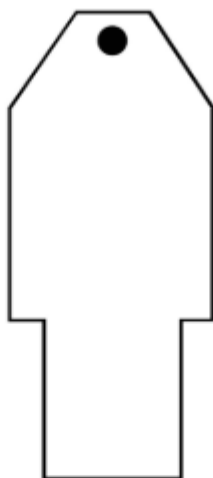

25mm

Stock bracket

Bend from 3mm thick 1/2" steel strap

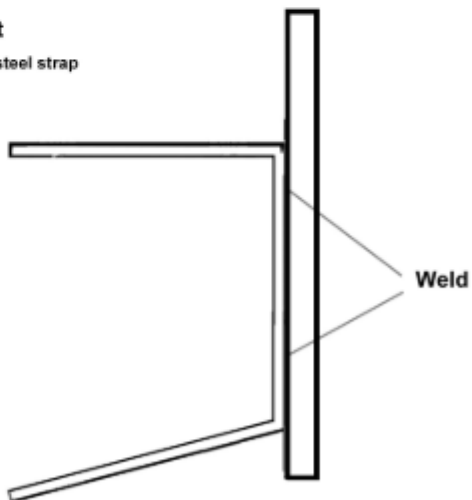

2 inches

Print on 8.5x11 US letter paper

Lower receiver (Assembled)

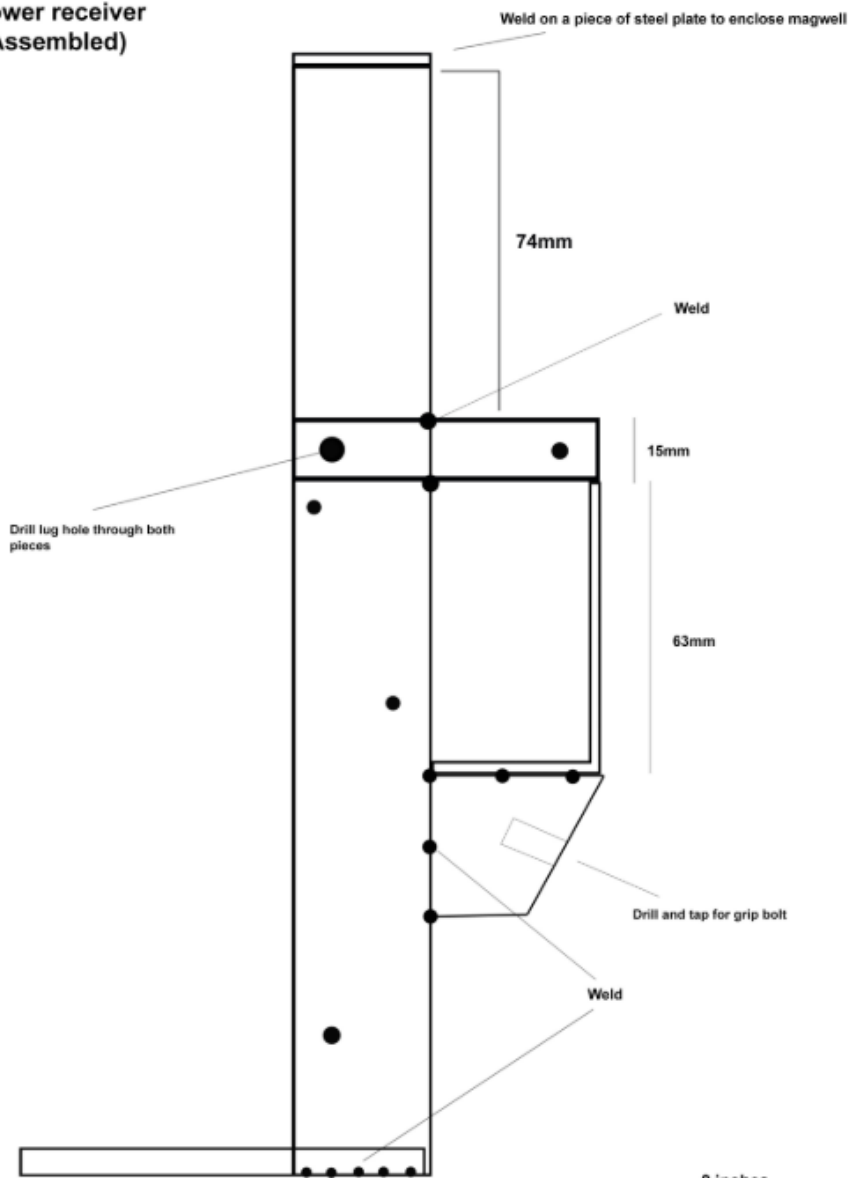

2 inches

Print on 8.5x11 US letter paper

Trigger & sear

10mm thick steel plate

Templates:

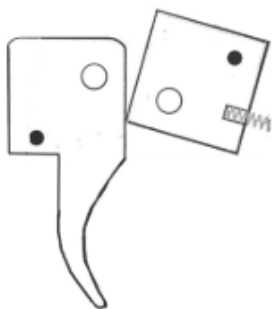
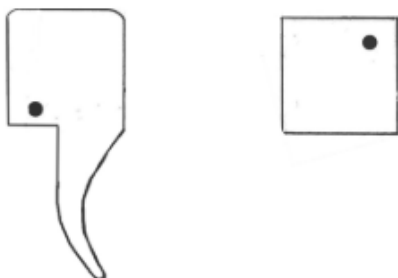

Drill and insert a 1" long 6mm dia steel bar through both trigger & sear to center each component in the lower receiver.
Drill a pocket and insert a small compression spring in position shown on sear

2 inches

Print on 8.5x11 US letter paper

Magazine body

Weld or braze together from 4 pieces of 20 gauge (1mm thick) mild steel sheet.

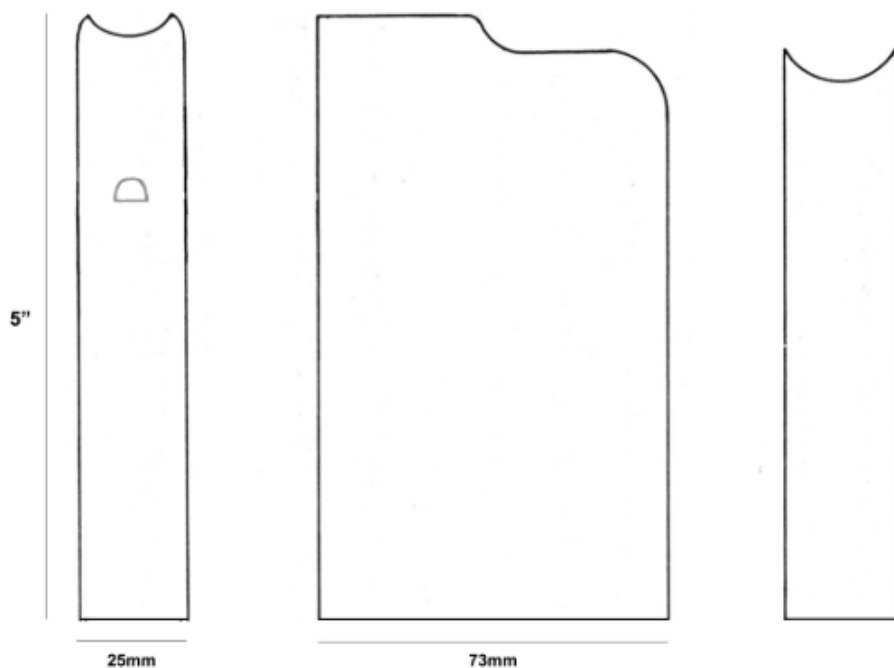

Can also be made by modifying a length of 1" x 2.5" or 1" x 3" rectangular steel or aluminum box section tubing with a wall thickness of 1.5mm. Alternatively FAL, SLR, BAR or G3 magazines may be modified to accept and feed 12 gauge shells.

2 inches

Print on 8.5x11 US letter paper

Magazine spring

Form from .025 flat spring steel strip, 3/4" wide

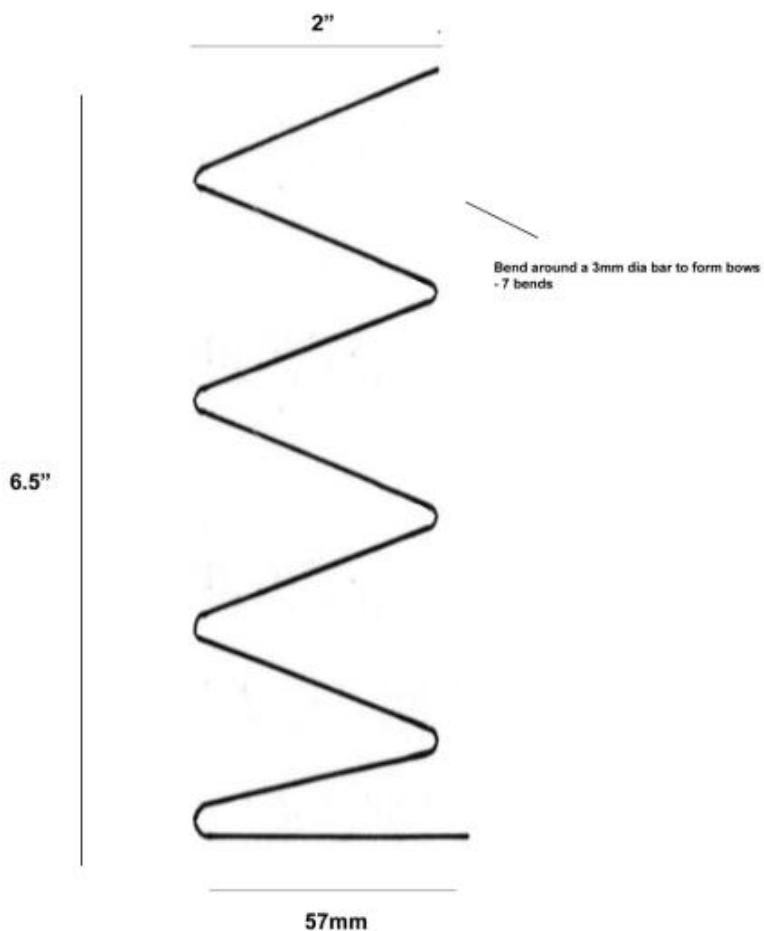

Magazine follower & assembly

Bend from 3mm thick, 20mm wide steel strip

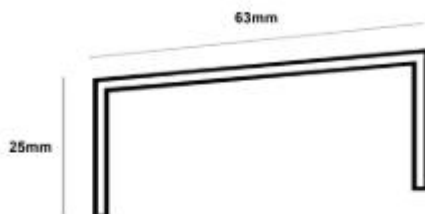

Bend lips inwards

18mm



Weld a blob of steel and grind to profile using a dremel.

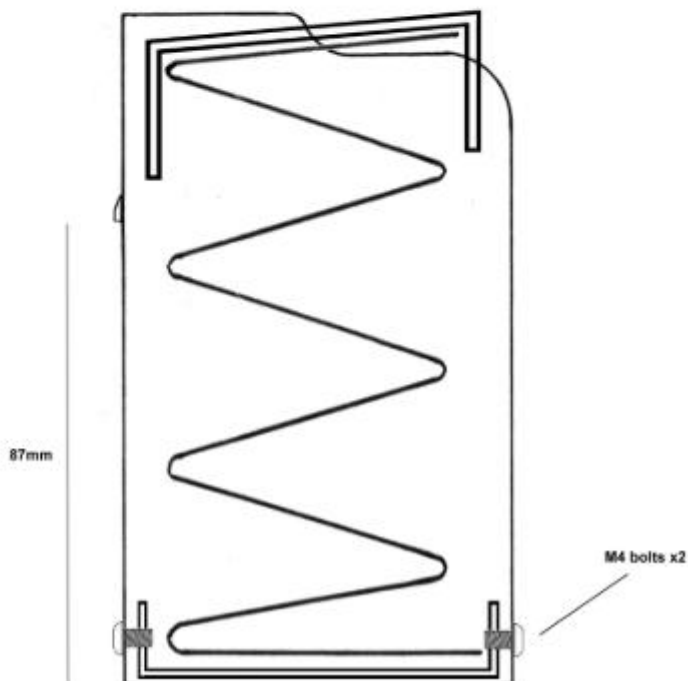

Bolt locking / unlocking sequence

When the pump forearm is fully forward the spring loaded locking lug on the bolt is free to engage with the lug slot in the top of the receiver, securely locking the bolt in place. When the pump forearm is pulled rearward the locking lug is pushed out of engagement with the locking lug hole by the action bar, enabling the bolt to travel rearward when the bolt peg makes contact with the front of the first slot in the action bar.

Bolt locked:

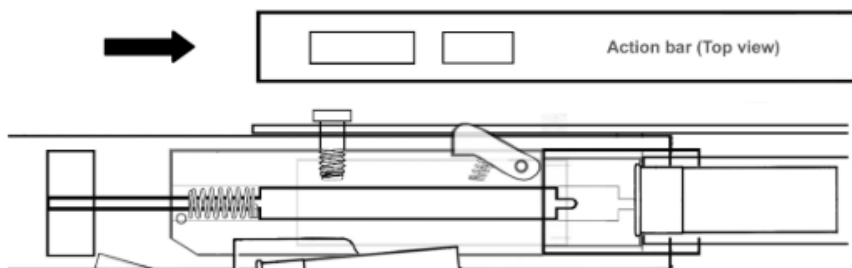

Bolt unlocked:

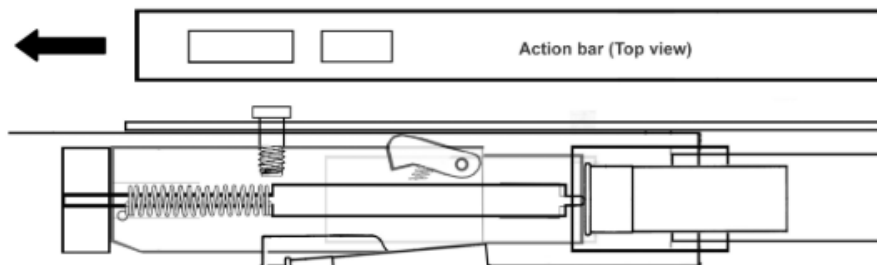

Inner bolt piece

Firing pin channel is bored through a 133mm long length of 1" (25mm) mild steel bar.



An alternative bolt construction method consisting of multiple lengths of steel tube and bar stock welded together

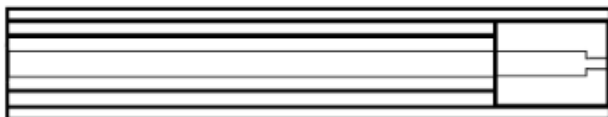

1" + 5/8" + 1/2" steel tube + 3/4" steel bar stock welded in front

2 inches

Print on 8.5x11 US letter paper

Firing pin

Turn to shape from 6mm dia steel bar stock

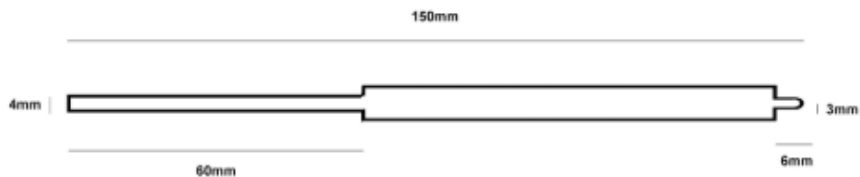

Can alternatively be constructed by sleeving a length of 4mm dia steel bar with an 84mm length of 6mm steel tubing.

Striker

30mm steel round or square bar

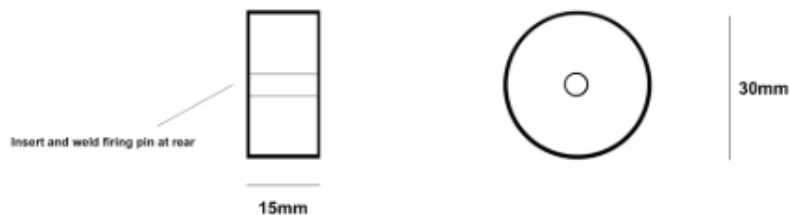

2 inches

Print on 8.5x11 US letter paper

Bolt body

30mm x 30mm x 2mm wall steel square box or round tube (1" ID)

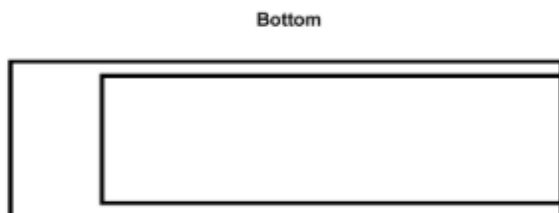
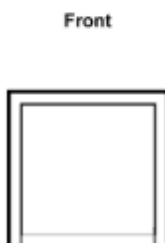
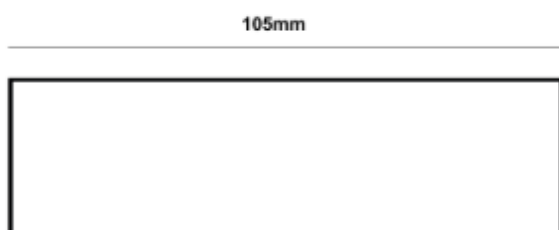

18mm

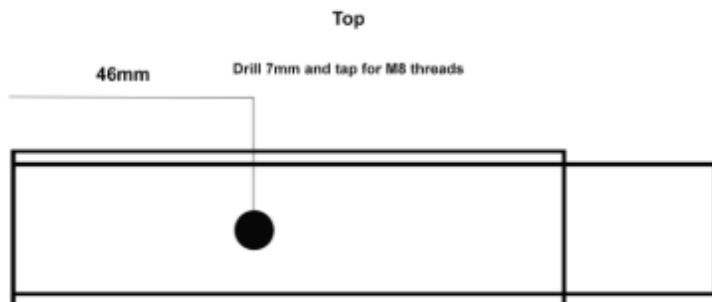

2 inches

Print on 8.5x11 US letter paper

Bolt locking lug

Cut to shape from 10mm thick steel plate or flat bar. Drill hole for 5mm dia, 30mm long pivot pin.

Template

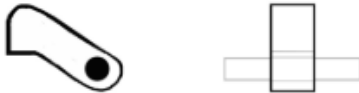

Drill a 5mm dia hole 6mm in from top and front of bolt body for lug pin. Grind out a pocket in bolt until the lug is able to pivot flush with top of bolt body.

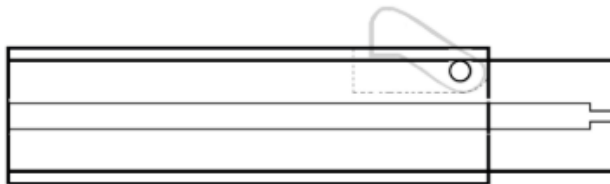

Drill a 6mm dia pocket hole in lug to accommodate a strong compression spring.



2 inches

Print on 8.5x11 US letter paper

Extractors

Cut from 2mm thick steel sheet. Harden.

Templates



Ejector

Modify from an M6 bolt, 10mm long



Cut ejector slot in bolt using an angle grinder fitted with a slitting disc. Slot should be 4mm wide, 7mm deep, 3" long



Drill 10mm from front / 4mm from sides

+ X2 4mm dia compression springs

2 inches

Print on 8.5x11 US letter paper

Bolt assembled

Side:

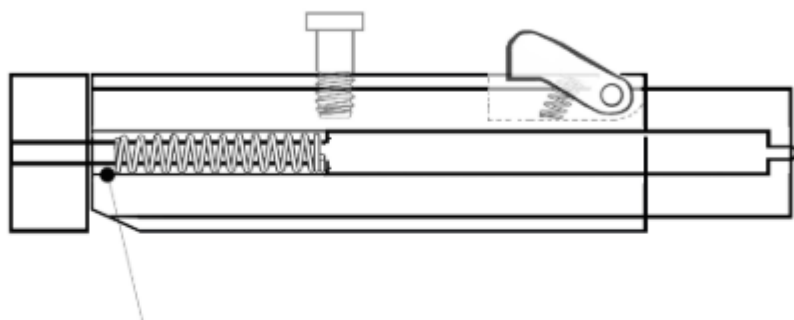

Drill a 4mm hole and insert a seloc pin to retain firing pin assembly

Front:

Bolt peg

M8 bolt - 15mm long

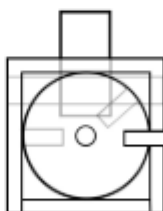

Weld bolt piece into bolt body

2 inches

Print on 8.5x11 US letter paper

Action bar

20mm wide, 2mm thick steel strip.
290mm long.

Rear end:

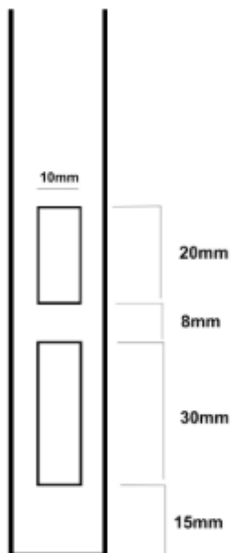

Front end:

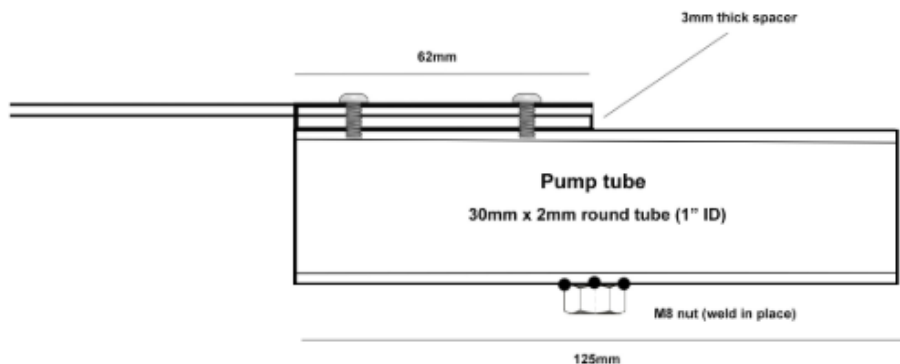

2 inches

Print on 8.5x11 US letter paper

Barrel

25mm x 2.5mm wall seamless steel tube (3/4" ID, 1" OD) - 20" long

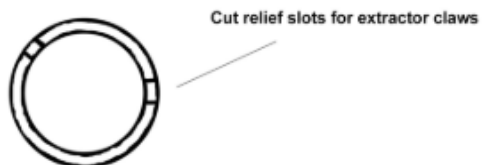

Bevel both collar and barrel entrance

Barrel collar

30mm x 2mm wall (1" ID)

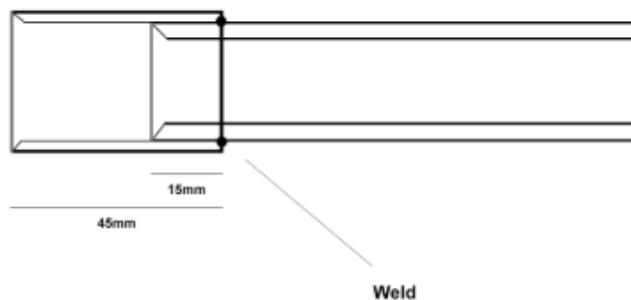

Front sight

3mm thick mild steel sheet

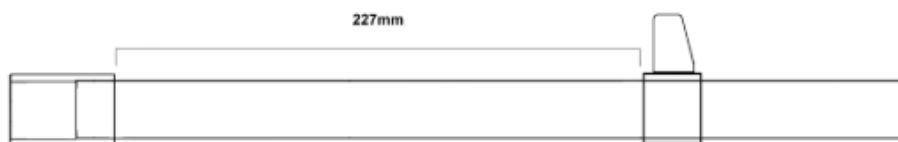
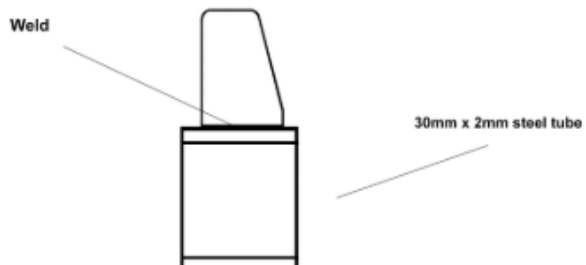

Weld front sight collar to barrel 227mm from chamber collar

2 inches

Print on 8.5x11 US letter paper

Pump forearm

2" thick hardwood or plastic

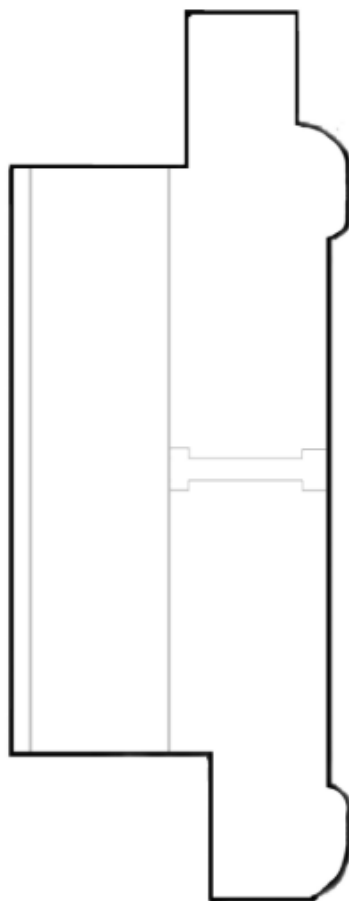

Front



Forearm is secured to pump tube via an M8 bolt

2 inches

Print on 8.5x11 US letter paper

Pistol grip

Cut from 1 3/8" thick hardwood or plastic

Drill a 6mm dia hole to secure grip to mounting block on lower receiver using a 3" long m6 bolt

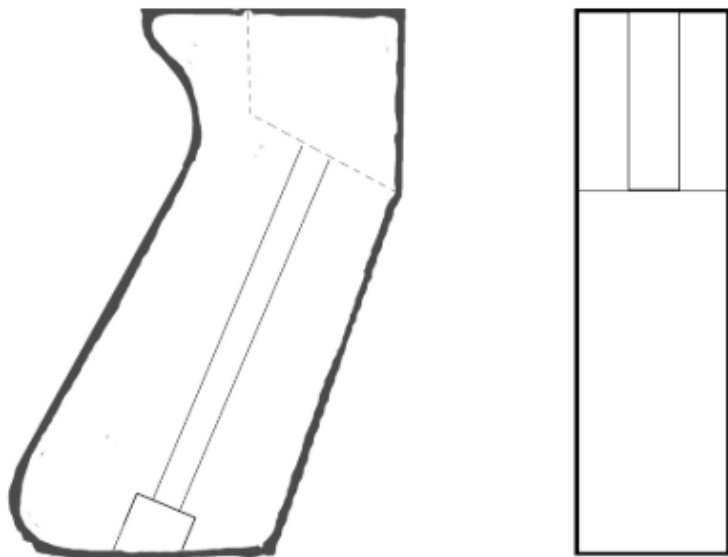

Alternatively weld in place a piece of steel plate and bolt on two grip panels either side to match the grip plate profile.

2 inches

Print on 8.5x11 US letter paper

2 inches

Print on 8.5x11 US letter paper

Stock

1.5" hardwood or plastic

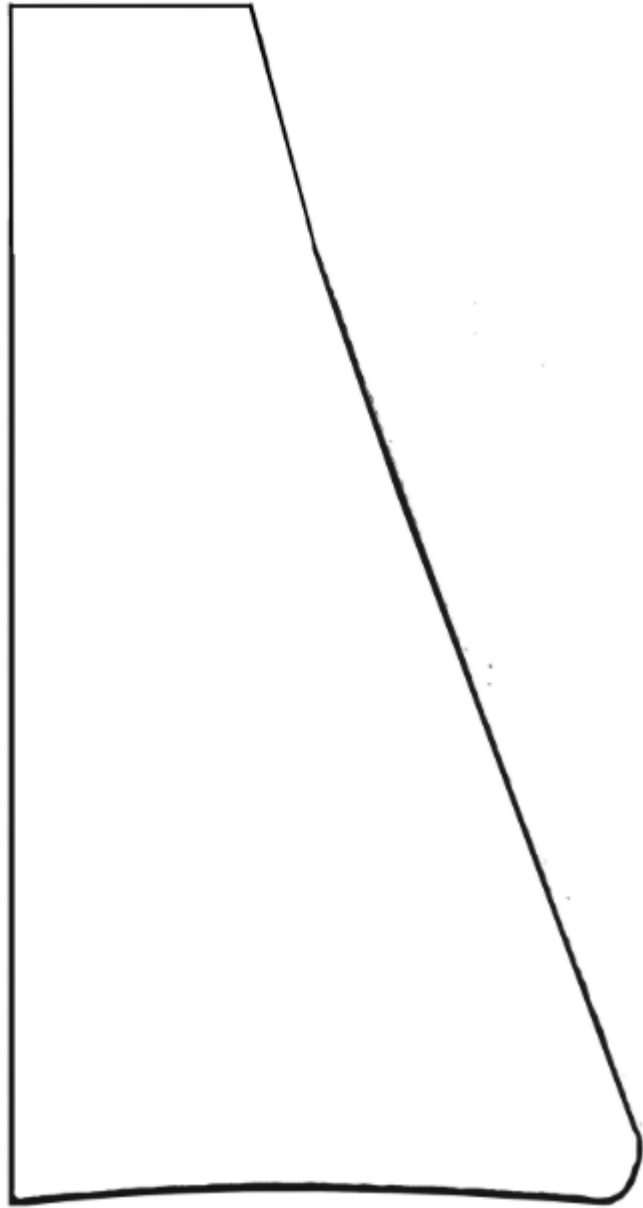

2 inches

Print on 8.5x11 US letter paper

Actual size

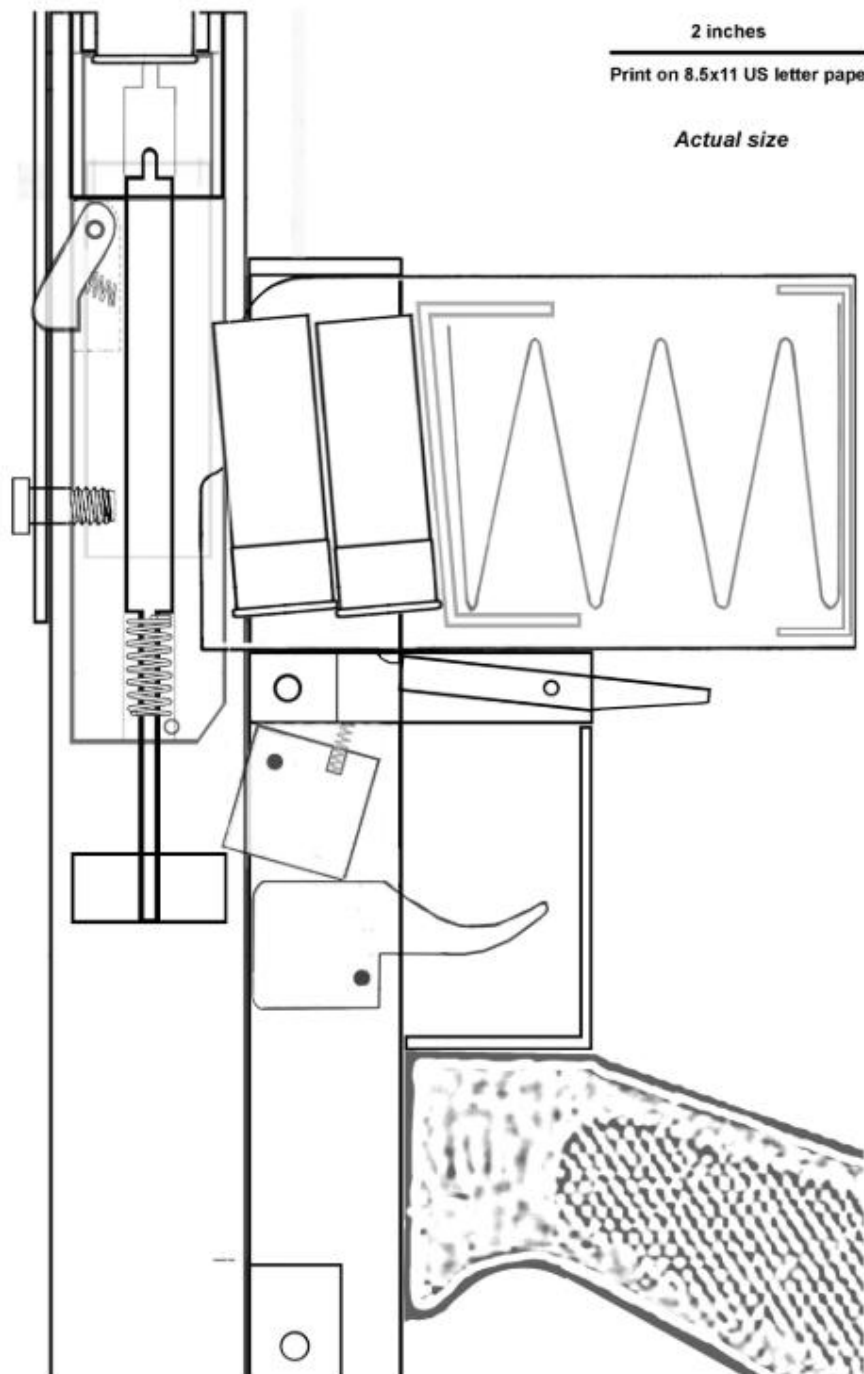

4. Ammunition

Cartridge size differs from weapon to weapon not only in the calibre (i.e. diameter) of the bullet, but also in the overall length of the case (e.g. 5.56 x 45 mm denotes a round of calibre 5.56 mm with a case length of 45 mm). Longer cases contain more powder, which can give more energy and thus higher velocities

Figure 2

Anatomy and operation of cartridge-based ammunition

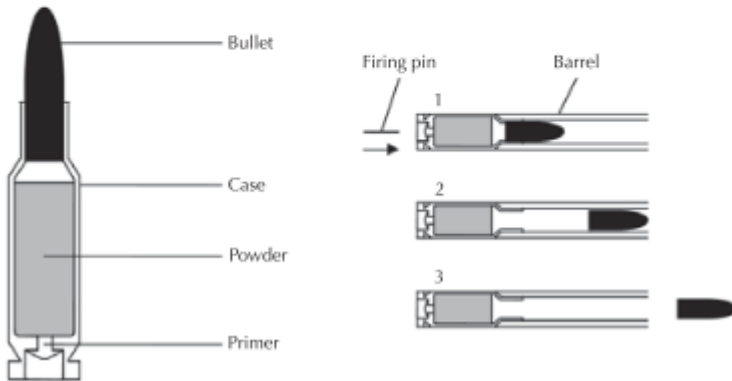

Ammunition standards

Types of weapons	NATO standards	Warsaw Pact standards
Assault rifles, light support weapons	5.56 x 45 mm	7.62 x 39 mm
Assault rifles, self-loading rifles, sniper rifles, light machine guns	7.62 x 51 mm	7.62x 54 mm
Pistols	9 x19 mm Parabellum	7.62 x 25 mm, 9 x 17 mm
Heavy machine guns, sniper rifles, anti-materiel rifles	12.7 x 99 mm	12.7 x 107 mm, 12.7 x 114 mm

Collated data from Jones and Cutshaw (2004).

Ammunition is oftentimes the bottleneck for any successful guerrilla actions and that is why on the following pages guides to manufacturing bulk ammunition of common types will be provided. Larger calibres can be researched online and it is recommended to consult Jane's Ammunition Handbook for specifications.



Figure 7-1

Components of a rifle cartridge. From left to right: the final, assembled cartridge, the brass shell casing, the lead bullet (in this case, a half-jacketed bullet), an empty shell on its side showing the primer pocket, a primer, and a small pile of gunpowder.

AMMUNITION

760. REMEMBER AMMUNITION CRITERIA.

When selecting a self-defense cartridge for your weapon, make certain that your ammunition fulfills these five requirements: (1) stopping power—it must be able to stop your assailant immediately from any further action; (2) controlled recoil—it should allow you to recover quickly from the recoil of your shot; (3) limited ricochet—it should significantly reduce the bullet's ability to ricochet off hard surfaces; (4) maximum penetration—it must be able to go through objects (e.g., car doors, furniture, etc.); (5) reliability—it must be free from various cartridge malfunctions (e.g., hang fire, misfire, or squib loads.)

761. STORE AMMUNITION SAFELY.

When storing ammunition, please take the following factors into consideration: (1) to ensure that your ammunition will function properly, always store your cartridges in a cool, dry place that is free from extremely high temperatures; (2) never submerge your cartridges in water or expose them to ammonia, bore cleaner, acids, salts, or petroleum products (including gun oil)—all solvents that can deteriorate the primer or power in your cartridge; and (3) for safety reasons, store ammunition so that it is inaccessible to unauthorized persons, especially children.

762. CHOOSE YOUR CALIBER CAREFULLY.

Don't make a .38- or .22-caliber pistol your first choice for personal protection. Its stopping power is somewhat questionable. Generally, when selecting a handgun for self-defense, choose a 9mm or higher caliber.

763. KNOW THE CARTRIDGE

— **FIRING SEQUENCE.**

Although it is critical to know how a firearm operates, it's also important to understand the cartridge firing sequence, which is as follows: (1) the firing pin strikes the cartridge primer, (2) the cartridge primer ignites, (3) the primer flame ignites the powder charge, (4) the powder charge burns quickly and produces a large volume of gas, and (5) the expanding gases push the bullet out of the cartridge case and sends it out of the barrel at a high rate of speed.

MALFUNCTIONS

764. KNOW THE THREE TYPES OF CARTRIDGE MALFUNCTIONS.

There are three different types of cartridge malfunctions that you need to be aware of. They include (1) misfire—the cartridge fails to fire after the primer has been struck by the firing pin; (2) hang fire—there is a delay in the ignition of the cartridge when the primer is struck; (3) squib load—there is less than normal pressure/velocity after the ignition of the cartridge.

765. USE THE TAP-RACK-BANG.

There may come a time when you will be faced with a malfunction caused by either a defective cartridge or a magazine that isn't inserted completely. When this problem occurs, you can solve it with the following tap-rack-bang technique: (1) tap—with your weak hand, tap the floorplate of the magazine back into the grip; (2) rack—with your weak hand, rack or cycle the slide, ejecting the defective cartridge and reloading a fresh one; (3) bang—resume firing your weapon.

766. PREPARE FOR AUTOLOADER MALFUNCTIONS.

Although the semiautomatic pistol is an extremely reliable tool, there is always the possibility of a malfunction. You must therefore be aware of the

different types of autoloader malfunctions and know their remedies.

- (1) **Out of battery.** One common autoloader malfunction occurs when the slide fails to go into battery after firing. To clear this malfunction, apply the following steps: a) maintain your position on your target; b) take your finger off the trigger; c) with your weak hand, slam the back of the slide with the heel of your palm; and d) resume firing.

- (2) **Smokestack.** Another type of malfunction is called the smokestack, which occurs when a spent casing is caught in the ejection port. To clear this malfunction, apply the following steps: a) maintain your position on your target; b) take your finger off the trigger; c) with your weak hand, rake the heel of your palm along the slide and the empty casing; d) knock the casing out of the breech; e) once the casing is clear, the slide should move forward, cycling a fresh round; and f) resume firing.



Automatics

An automatic rifle is one which ejects the old, spent cartridge and then inserts a new, fresh cartridge in the firing chamber with no manipulation required on the part of the shooter. We think of automatic weapons as modern, but the first automatic weapon used by a military organization was employed by the Danish navy in the 1880's — a hundred years ago!

With a "semi-automatic" rifle, the trigger must be pulled, released, and pulled again for each repeat shot. With a "full automatic" rifle, the gun continues to fire, round after round, as long as you hold back the trigger. In everyday language, both types are called "automatics."

With other action types, the power required to eject the old shell and insert the new shell is provided by the arm of the shooter. With an automatic, the power required to work the action is derived by stealing some of the force being used to propel the bullet.

A hole is drilled sideways into the rifle barrel. When the gun is fired and the bullet is halfway to the muzzle it passes this hole and some gas escapes. The pressure of the gas escaping through the hole is channeled to throw the bolt — otherwise done by the arm of the shooter.

The advantage of an automatic weapon is fast repeat shots with no distraction to the shooter. He can hold his aim on the target and continue to shoot. The disadvantages are cost (automatics are expensive), reliability (automatics are complicated mechanisms and sometimes jam), and strength (the most powerful calibers are not chambered in automatics).

Head Space

In a factory-made gun, the space which exists between the rear of the cartridge and the front of the breech plug is called "head space." If the head space is excessive, the expanding gunpowder inside the cartridge stretches the cartridge case until it breaks. If this happens, damage to the gun usually results — and sometimes to the shooter, as well.

Head space increases as a gun wears. Gunsmiths have dummy cartridges they can use to check the head space in old guns. Past a certain point, too much headspace means that a gun is not safe to shoot.

To understand why, think of a prizefighter punching his opponent in the jaw. Imagine his glove being glued to the other man's jaw. He couldn't get off much of a punch if no slack existed. But if his fist had two inches of "running start," he could do some real damage.

The same principle holds true in firearms. If the cartridge fits loosely in the gun's chamber, the surge of pressure can rupture the shell casing and give it a running start before it slams into the rear wall of the chamber. In the homemade gun described in Chapter 3, the breech plug screws into the rear of the barrel and eliminates head space. It automatically compensates for differences in rim thickness, wear in the gun, and so forth.

A different kind of head space can exist in homemade firearms and be a cause for concern, however. The mismatch of diameters between the outside of the cartridge and the inside of the barrel sometimes results in a sloppy fit. The best policy is to test fire the gun by remote firing (see Chapter 3, Figure 3-50) prior to hand-held firing. It should be test fired with a more powerful load than will be employed in everyday use.

Caliber Explanation

The topic of calibers is confusing. You might think that the bigger the caliber, the more powerful the gun. 'Taint necessarily so. Although the caliber does denote the bullet diameter, you can have a small bullet backed up by a large powder charge or a large bullet backed up by a relatively small charge. The following is a basic list of rifle calibers and a description of their capabilities.

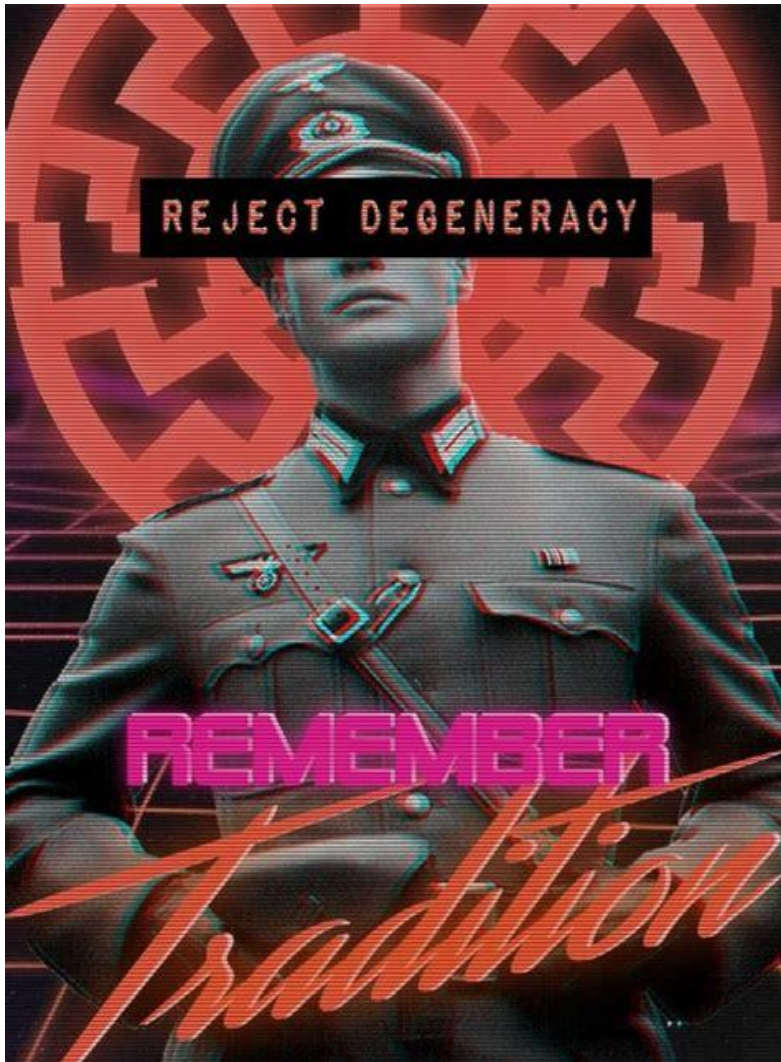

.22 Rimfire .22 shorts are good to 50 yards on small pests such as rats, squirrels, crows, and snakes. .22 long rifle cartridges are adequate to 75 yards. .22 shorts can be stabilized with a 1-24 rifling twist. .22 long rifles require a 1-16 twist. The longer the bullet, the sharper must be the twist.

.22 Hornet Introduced by Winchester in 1930. Good to 175 yards on varmint-sized game (foxes, turkeys). It is too light a caliber for deer. The metric designation is 5.6 x 35R. The rifling twist is 1-16 (that is, one full twist for each sixteen inches of barrel length).

.222 Remington Introduced in 1950. Good to 225 yards on varmints. Outstanding accuracy to 200 yards. Rifling twist is 1-14.

.223 Remington Adopted by the U.S. military in 1964 as the 5.56 mm. An excellent varmint cartridge to 250 yards. Metric designation is 5.56 x 45mm. Rifling twist is 1-14.

.22-250 Began as a wildcat cartridge in the 1930's. Wildcat means home-loaded; not available in factory loads. It was a .250 Savage case necked down to accept a .22 caliber bullet. Now available commercially, it's a varmint cartridge with an effective range to 300 yards. Rifling twist is 1-14. This is a high velocity, flat shooting load with a loud muzzle blast. The supercharged load results in fast barrel wear.

.220 Swift Introduced in 1935 by Winchester. Effective range to 350 yards. It was the first factory cartridge with a muzzle velocity of over 4000 feet per second (fps). Rifling twist is 1-14. No rifle is made for the .220 Swift today.

.243 Winchester This is really a .308 Winchester necked down to take a .243" diameter bullet (6mm). In the wind, it is superior to any .22 caliber bullet. Good to 300 yards; big enough for deer. Light recoil. Rifling twist 1-9. Metric designation is 6 x 51mm.

.250 Savage Introduced by Savage Arms in 1915. Delivered 3000 fps muzzle velocity. Good to 250 yards. Popularity declined with the introduction of the .243 Winchester.

.257 Roberts Designed by Ned Roberts and introduced by Remington in 1934. Good to 250 yards and big enough for deer. Rifling twist of 1-10. Popularity waned with the introduction of the .243 Winchester.

.270 Winchester The .270 is a necked-down .30-06 case. Good to 325 yards. With hand loads, it ranks near the top for long range accuracy. With heavier bullet weights it will take all North American big game except the larger bears. Rifling twist is 1-10. A contender for best all-round big game rifle.

7mm Remington Magnum Introduced in 1962. Very flat trajectory. Effective range of 350 yards. Rifling twist is 1-9. Fast barrel wear results from "hot" loads.

7mm Mauser The Spanish military cartridge of 1893. Velocity and trajectory characteristics are less than the .270 but killing power is far in excess of the .30-30.

.30 Carbine The .30 M1 Carbine was developed by the Army in 1940 as a substitute for a pistol. As a rifle cartridge it is neither very powerful nor accurate. It should not be used on game larger than coyote. Useful range is 100 yards.

.30-30 Introduced in 1895 for use in the '94 Winchester lever action. It was the first sporting cartridge loaded with smokeless powder. Its popularity is due to the guns which are chambered for it — flat, light lever actions that are well balanced and easy to handle. Adequate on deer to 175 yards. The metric designation is 7.62 x 51R. Rifling twist is 1-12.

.300 Savage Introduced in 1920 for use in the Savage 99 lever action. It has nearly the power of a .30-06 but has a much shorter case, thus lending itself to action types other than bolt action. Declined in popularity with the introduction of the .308. Useful range is something less than 300 yards.

.308 Winchester Civilian version of the 7.62mm NATO cartridge. Better performance than a .300 Savage and nearly as good as a .30-06. It has the advantage to gun designers of having a shorter case than the .30-06. Rifling twist is 1-10.

.30-06 Springfield A .30 caliber cartridge adopted by the U.S. Army in 1906. Generous case capacity makes it a versatile cartridge for reloading. Useful range to 325 yards. Adequate for all North American big game except grizzlies and Alaskan brown bear. Rifling twist is 1-10.

.300 Winchester Magnum A belted magnum cartridge introduced in 1956. Has flat trajectory. When sighted in at 250 yards, is 2.9" high at 150 yards and 3.5" low at 300 yards. The 7mm magnum is slightly flatter but not as powerful. Special target rifles have produced outstanding accuracy to 1000 yards. Useful range for hunting arms is 350 yards. Adequate for all North American big game except the larger bear. Rifling twist is 1-10.

.303 British The British service cartridge adopted in 1888 and used through Korea. The shell is both rimmed and tapered. The bullet is .30 caliber, but the rear end of the case is .455 inches, only .001 less than a .44 Magnum. This is a long cartridge like the .30-06 with ballistics similar to the .300 Savage. Metric designation is 7.7 x 57R.

.35 Remington Introduced in 1906. A competitor of the .30-30. Has better stopping power than the .30-30. The rifling is typically cut shallow, wears comparatively quickly, and accuracy suffers.

.375 Winchester A recent introduction by Winchester. A competitor of the .444 Marlin.

.375 H & H Magnum Introduced in 1912 by Holland & Holland. An African big game rifle, unnecessarily powerful for North American big game. Unique in that it shoots different bullet weights to the same point of impact. Double the recoil of the .30-06.

.44 Magnum Introduced as a pistol cartridge in 1956, now chambered in rifles. In the same class as a .30-30 or .35 Remington, it has better stopping power than either.

.444 Marlin Introduced in 1964 for Marlin's lever action. Useful range is 150 yards. Can be thought of as a much beefed-up .44 Magnum, from a performance point of view.

.45-70 Government U.S. military cartridge from 1873 to 1892. It has a straight case and is rimmed. Originally loaded with black powder, it has a large case and can be hand loaded with 500 grain bullets to a point where it approaches a .458

Winchester. Only new single shot and bolt action rifles are strong enough for this. The old "trap door" military rifles would burst from such pressures. With factory loads, effective range is 150 yards.

.458 Winchester Magnum Introduced in 1956. Replaced the .375 H & H as the most powerful commercial load. Also has the most recoil. Jacketed, 500 grain bullets are available for rhinos and tanks. Rifling twist is 1-14. The cartridges are belted.

Pistols

9mm Parabellum This is the 9mm Luger cartridge adopted by the German military in the early 1900's. It is used in both automatic handguns and submachine guns, not for serious target competition. It is not a powerful load. The shell does not have a rim.

.38 S&W Introduced in 1877 by Smith & Wesson. Slightly less powerful than the .38 Special. A straight, rimmed case.

.38 Special During the 1899 Philippine campaign the then-standard .38 Long Colt was found inadequate. The .38 Special replaced it and is the most widely used pistol cartridge of all time. Adequate for varmint hunting. Straight, rimmed case.

.357 Magnum Dates from 1935. Triple the muzzle energy of the .38 Special. Straight, rimmed case. It is chambered in some rifles.

.41 Magnum Between the .357 Magnum and the .44 Magnum in both performance and recoil.

.44 Magnum See rifle cartridges, above.

.45 Auto Rim Dates from 1922. Reduced popularity since the introduction of the *.44 Magnum*. Straight, rimmed case. Still manufactured by Remington.

.45 ACP Adopted by the U.S. Army in 1911. It's used in *.45* caliber automatic pistols. Has a straight, rimless case.

.45 Colt Straight, rimmed case. In use for a hundred years. Preceded the *.45 ACP* as the U.S. Army service cartridge. Used in revolvers.

Shotgun Gauges

If a pound of lead was split into ten equal lumps, and then a second pound of lead was split into twenty equal lumps, which lumps would be larger? The ten-to-the-pound lumps, of course.

That is how shotgun gauges are determined. The lumps are formed into balls, and the diameter corresponding to ten-to-the-pound balls is 10 gauge. The smaller diameter corresponding to 20-to-the-pound lead balls is 20 gauge.

The ordinary gauges are 10, 12, 16, and 20. Ten gauge shotguns are used for geese. Twelve gauge guns are the most popular size and best for general purpose. Sixteens have faded in popularity — hunters seeking more power have gone to the twelve; those seeking light weight have gone to the twenty.

There is also a *.410* gauge. The *.410* designation is really the caliber or bore diameter in inches and is not based on the same gauging system as other shotguns.

The *.410* is smaller in diameter than any other shotgun. Its capacity to hold both powder and shot is less than other gauges and it compares poorly in range and stopping power. In those

places where deer hunting is restricted to the use of shotguns loaded with slugs, the *.410* is not allowed. It lacks adequate stopping power.

See *Expedient Homemade Shotgun Ammo* by P.A. Luty for guidance on how to manufacture shotgun ammunition.

1. Manufacturing Ammunition

Watch Making Copper Bullet Jackets for an illustration of some of the tools and techniques used: <https://www.youtube.com/watch?v=o0JVM76Y37I>

YouTube tutorials are a powerful tool to gain an insight into the topic.

Straight-sided shells with rims will work the easiest in homemade firearms. Below is a listing of straight-sided rimmed shells. The diameters can be compared to the pipe dimensions given above.

<i>Caliber</i>	<i>Bullet Dia</i>	<i>Rifles</i>	
		<i>Shell OD</i>	<i>Rim OD</i>
.22 Rimfire	.224	.224	.272
.375 Win.	.375	.418-.400*	.506
.444 Marlin	.429	.470-.453*	.514
.45-70 Govt.	.458	.505-.480*	.608

		<i>Pistols</i>	
		<i>Shell OD</i>	<i>Rim OD</i>
.38 Super	.355	.380	.406
.38 S&W	.357	.380	.440
.38 Special	.358	.379	.440
.357 Magnum	.358	.379	.440
.41 Magnum	.410	.434	.488
.44 Special	.433	.456	.514
.44 Magnum	.433	.456	.514
.45 Auto Rim	.454	.476-.472*	.516
.45 Colt	.454	.480	.512

		<i>Shotguns</i>	
		<i>Shell OD</i>	<i>Rim OD</i>
12 Gauge	-	.812	.875
16 Gauge	-	.750	.812
20 Gauge	-	.703	.766
.410 Bore	-	.478	.531

* indicates taper

Based on the above charts, a .22 rimfire cartridge would fit in 1/8" Schedule 40 pipe. In fact, as the diameters are the

same, .22 short, .22 long, .22 long rifle, and .22 Magnum could all be fired in a gun made from such pipe.

In the case of a rimfire it is the rim, not a primer, which must be crushed to cause ignition. For the firing pin to contact the rim, it must be located off center in the breech plug. See Figure 4-1. When the breech plug is screwed into the collar, the firing pin may end up in the 6 o'clock position, the 12 o'clock position, or some intermediate position. The hammer must be wide enough to contact the firing pin in whatever position it is presented.

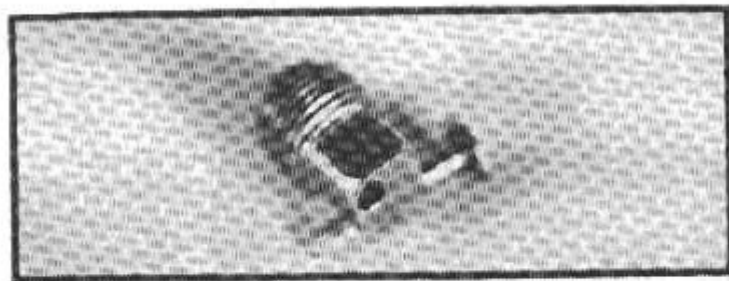

Figure 4-1

The firing pin must crush the rim of the .22 caliber rimfire cartridge to detonate it. Thus, the hole for the firing pin in the breech plug must be drilled off center, as shown.

A .38 S&W, .38 Special, and .357 Magnum all have *bullet* diameters that will fit in 1/4" Schedule 40 pipe. However, in each case the pipe must be drilled out to accept the diameter of the shell casing. See Figure 4-2. A 25/64" fractional drill or a letter size W drill are the bit sizes to use. Drill to a depth of 1 1/4".

A .41 Magnum *bullet* will fit in 3/8" Schedule 80 pipe. The pipe must be drilled out to accept the shell casing. See Figure 4-2. Use a 7/16" bit and drill to a depth of 1 1/4".

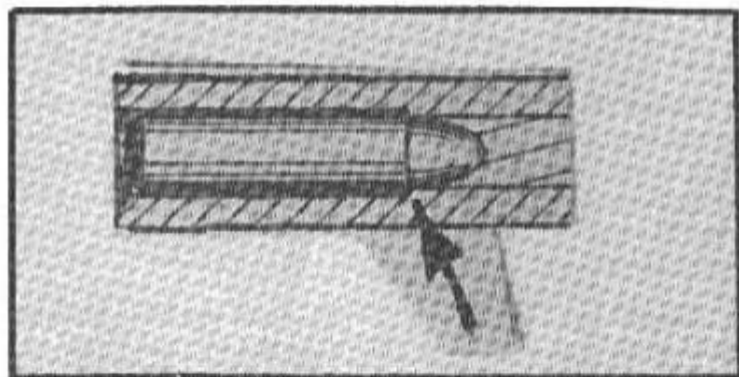

Figure 4-2

With some calibers, the bullet diameter will fit in the pipe but the shell diameter will not. The necessary clearance can be obtained by drilling out the pipe ID to the appropriate diameter and depth. The arrow in the illustration points to the potential conflict in clearance.

The .375 Winchester will fit in 3/8" Schedule 80 pipe. No drilling is necessary.

The .44 special, .44 Magnum, .45 Auto Rim, .45 Colt, and .410 bore shotgun will all fit in 3/8" Schedule 40 pipe. No drilling is required. The .444 Marlin is a sloppy fit in this size pipe and I would recommend against its use.

The .45-70 Govt. *bullet* will fit in 3/8" Schedule 40 pipe and in 1/2" Schedule 160 pipe. Both pipe sizes require drilling with a 33/64" bit to a depth of 2 1/8" for shell casing clearance.

The .35 Remington is a necked cartridge which will fit in 3/8" Schedule 80 pipe with a bit of drilling. Drill with a 15/32" bit to a depth of just over 1 9/16". The depth is fairly critical but is best determined by trial and error. It is critical because the shell is rimless and will be held in place by the shoulder instead of by a rim.

Several shells have straight sides and would lend themselves to the type of firearm described in Chapter 3 except that they lack rims. "Rims" can be added, however, by the use of retaining rings. See Figure 4-3. It may be necessary to file off part of the retaining ring's "ear" to obtain clearance within the gun's collar.

The .30 M1 Carbine and the .32 Auto are both straight-sided shells that will fit into 1/4" Schedule 40 pipe. They are both rimless, but a 3/8" retaining ring can be used to solve that problem.

The *bullet* of the .380 ACP and of the 9mm Parabellum will fit in 1/4" Schedule 40 pipe. In both instances the pipe must be drilled out with a 13/32" bit to a depth of one inch to accept the shell casing. Use 3/8" retaining rings to create rims.

The .45 ACP and the .45 Winchester Magnum will fit in 3/8" Schedule 40 pipe. No drilling is required. Use 1/2" retaining rings for rims.

Retaining rings and the special pliers with which to install and remove them can be obtained at an automotive supply store. The sizes indicated here can actually be put on with the fingers and do not require special pliers (assuming you have fairly strong fingers, of course).

Necked Cartridges

By employing pipe reducers, it is possible to use necked cartridges in the type of firearm described in Chapter 3. The neck rather than the rim holds the cartridge in place. Therefore, retaining rings are not necessary even on rimless shells. Because gaps are inevitable between the cartridge and the chamber holding it, many broken shell cases and extraction problems should be expected.

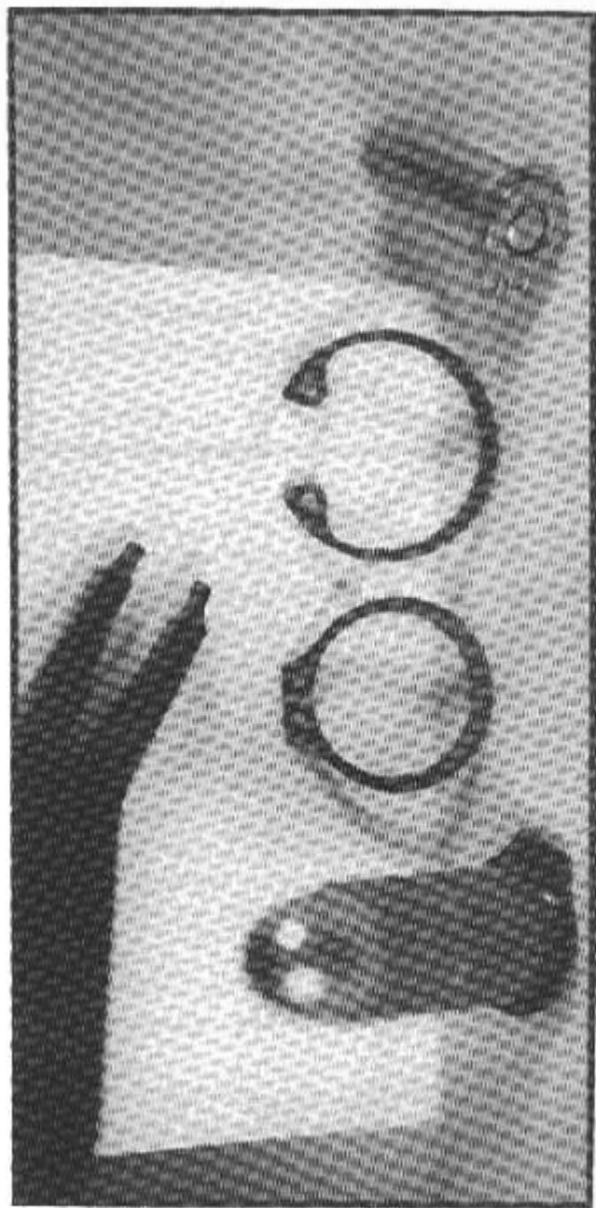

Figure 4-3
Rims can be provided by seating retaining rings in the grooves located in the rear of rimless shells. The protruding "ears" may have to be filed away to provide clearance. Two different styles of retaining rings are shown along with a special pair of pliers used to install retaining rings.

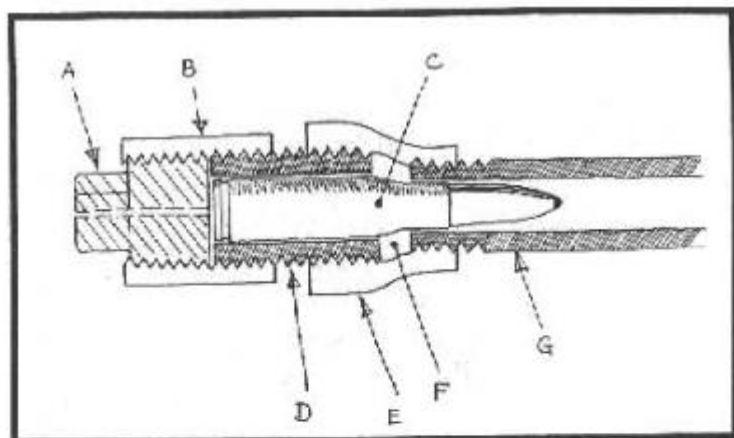

Figure 4-4

Using adapters for necked cartridges. "A" is the breech plug. "B" is the collar. "C" is the cartridge itself. "D" is the nipple which must be custom cut to length for each caliber and shell size. "E" is the reducer — the heart of the whole affair. "F" is the space, a kind of headspace, where a potential blowout of the shell casing can occur. "G" is the barrel.

When using the following directions, refer to Figure 4-4 to see the role being played by the component in question. These directions deal with diameters, not lengths. It is suggested that the nipple be 3" long to start, sawn to approximate length, and filed to finish length — being assembled and disassembled as needed for trial measurements each step of the way. In each case, the collar and plug required is the same nominal size as the large end of the reducer.

Crushed Match Heads as Gunpowder

Probably the very simplest way of making gunpowder is to crush up match heads. Safety matches will work, as will strike anywhere matches with the sensitive tip portion removed. The tip portion is too sensitive, too fast burning, too close to being high explosive, for safe use as gunpowder.

To “manufacture” gunpowder from match heads, shave or peel the combustible material off the heads of several matches. In the case of strike anywhere matches, first remove the tip portion. The tips can be saved for use in primers, as explained in Chapter 6. Be careful removing the tips from strike anywhere matches. You would not feel too clever if a tip you were removing flared up and fell into a pile of others previously removed.

After the match head material has been removed from the match stick, simply dice it up into a powder with a knife. Unlike a primary explosive which is sensitive to both friction and shock, the danger of accidental ignition with this material is very small — if you wait for safety matches to ignite from banging them together, you will wait a long time.



The crushed up match head material is gunpowder. It can be loaded as is into a rifle cartridge and fired. Sounds too simple to work, doesn't it?

There is less recoil or "kick" in a firearm loaded with match head powder, compared to factory loads. This means that match head powder is less powerful than factory loads and can be safely substituted on a one-to-one volume basis.

U.S. Army Manual TM 31-210 on improvised weaponry says that 58 match heads (that is, what is left of a strike anywhere match after the primary tip has been removed) will be required for a .308 Winchester cartridge.

The following chart shows how many match heads are required for other calibers. I calculated the requirement two ways: first, based on shell case volume prorated from the 58 match heads for a .308 Winchester indicated above. Second, based on a substitution rate of 1.5 match heads for each grain of smokeless powder used in typical loads. In the interest of safety the lowest of the two values appears below:

<i>Rifle</i>	<i>Number of Match Heads</i>
.22 Hornet	13
.222 Remington	26
.223 Remington	39
.243 Winchester	61
.30 M1 Carbine	16
.30-30 Winchester	45
.308 Win. (7.62mm NATO)	58
.30-06	74
.375 H&H Magnum	87
.44 Magnum	32
.45-70 Govt.	76
.458 Winchester	79
 <i>Pistols</i>	
9mm Parabellum	8
.38 Special	15

.357 Magnum	26
.45 ACP	27
<i>Shotguns</i>	
12 Gauge	33
16 Gauge	30
20 Gauge	27
.410 Bore	19

A couple of incidental points. A new box of Diamond brand strike anywhere matches contains 263 matches. Also, you won't get more power by overloading the shell casing with match head powder. If you put too much of this powder into a plastic shotgun shell, you won't get more penetration — all you'll do is melt the plastic case. See Figure 5-1.

Potassium Perchlorate and Sugar

The chemical symbol for potassium perchlorate is $KClO_4$. It is a white powder. Potassium perchlorate is made by heating potassium chlorate. The potassium chlorate decomposes, yielding oxygen, potassium perchlorate, and potassium chloride (common salt).

If you mix 2 parts potassium perchlorate and one part table sugar, by volume, a gunpowder results with a rating of "4." A simple mixing of powders is all that is required.

Potassium perchlorate can be purchased from Merrell Scientific. See Chapter 6 for the address.

The process for manufacturing Sodium Chlorate from table salt is outlined in the explosives section and in Ronald B. Brown's *Homemade Guns & Homemade Ammo*.

2. Primers

Ammunition is the Achilles' heel of firearms. If ammunition sales were to be restricted, guns would be rendered useless. Not so, you say, for the person who loads his own. No? What about primers? Primers are the Achilles' heel of ammunition.

Bullet material can be improvised. And gunpowder, as seen in the last chapter, can be made from scratch. But the raw materials from which primers are made pose a far greater problem. Mercury fulminate, antimony sulfide, lead peroxide, picric acid, lead azide, and nitromannite are not off-the-shelf items in your local drug store or anywhere else. These materials are difficult to obtain and dangerous to manufacture. The two methods given in this chapter represent the only primer materials I have been able to find which are both obtainable and reasonably safe.

To understand the relationship of the primer to the rest of the cartridge components, consider how you would build a fire in your fireplace. First you would light a wadded ball of newspaper. Then you would add some kindling — twigs, wood splinters, shavings. Next you would add some finely split hardwood; and lastly, the great chunks that you really wanted in the first place.

Most metallic primer cups are made of cartridge brass; steel may also be used. Similar to cups for cartridge cases or bullet jackets, primer cups are produced on a cupping press.

After cupping, the parts are tumbled to remove sharp edges at the open end of the cups. This smooths the cup, making insertion in cartridge cases easier. Most commercial primer cups are nickel-plated for corrosion resistance.

Anvils, the smallest of ammunition components, are made on a small blanking press. Sheets of brass are fed into a press fitted with multiple blanking punches. Dies set below the punches shape the anvil into the three-dimensional form.



How a Primer Works

If you inspect a fired primer which has been removed from a center-fire rifle shell, you will notice several things: it is shaped like a miniature cup; it is dented where it was struck by the gun's firing pin; it contains a residue, left from the primary explosive, now burned away; and, inside the cup, it contains a small two or three legged piece of metal called an anvil. See Figure 6-1.

In your imagination, enlarge the primer until it is the size of a coffee cup. Imagine it to be of thin brass. The extreme tip end of strike anywhere matches is a primary explosive. Imagine match tip material had been dissolved in water, poured into the brass coffee cup like jello in a jello mold, and allowed to harden.

The coffee cup is now filled with one giant match tip. If you banged the cup on the table, would it go off? No. If you hung the cup on a string and struck the bottom with a hammer — hard; hard enough to dent the bottom — would the match tip material ignite and burn? No, it would not.

But take just one strike anywhere match tip — the very tip portion — and lay it on a blacksmith's anvil. Pound it, one



blow, with a metal hammer. Will it go off? Yes. When crushed between two metal surfaces, it will explode and sound like a cap gun.

This, then, is the function of the anvil in the primer. The primary explosive must be crushed between two metal surfaces in order to detonate. The inside "back wall" of the primer cap provides one surface. The anvil provides the other.

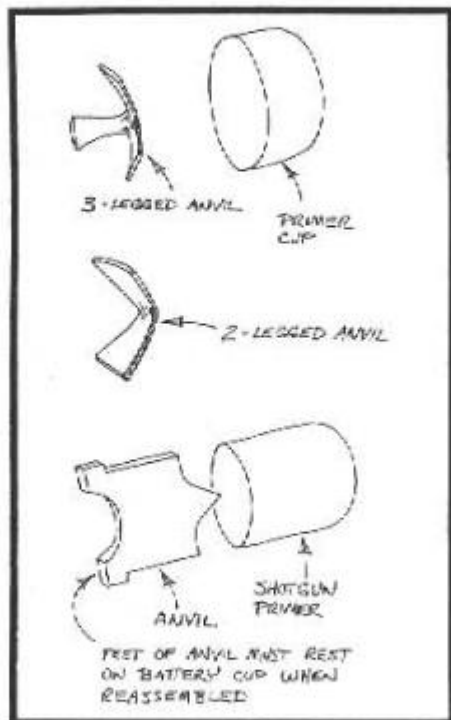

Figure 6-1

Anvils come in different shapes, but all perform the same function in the primer. They provide a surface against which the primary explosive can be crushed.

The gun's firing pin strikes the back of the primer, denting it, and crushing the trapped primary explosive between the primer wall and the anvil. The primer will not work without the anvil. When the primer is assembled in the shell casing, the shell casing itself prevents the anvil from being pushed out of the primer cup by the impact of the firing pin.

Strike Anywhere Match Tips

The modern strike anywhere match (see Figure 6-2) contains a small quantity of phosphorous trisulfide at the very tip. This is a primary explosive, sensitive to both friction and impact. When the match tip is lit, it ignites, in turn, the main body of the match head.

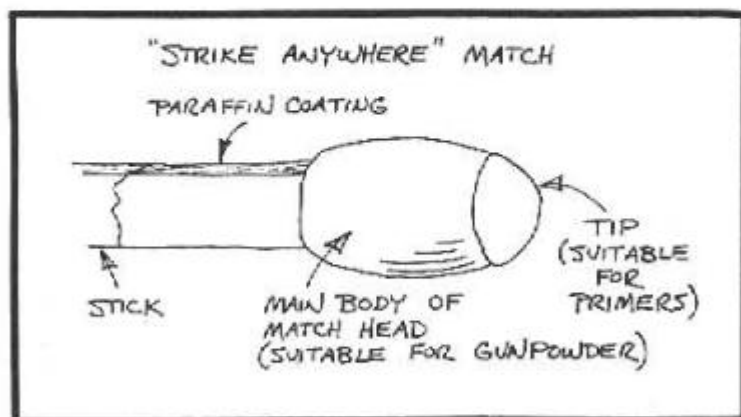

Figure 6-2

The tip portion of the common strike anywhere match is a primary explosive, and can successfully be used in primers.

The phosphorous trisulfide tip (the white part in Diamond brand matches; the light blue part in Ohio Blue Tip) is important because it will serve in primers. The rest of the strike

anywhere match head (the red part of Diamond matches; the dark blue part of Ohio Blue Tip) will serve as gunpowder but is not friction sensitive or shock sensitive to a suitable degree for use as a primary explosive in primers.

Heads from *safety* matches will not work either. They are simply not sensitive enough to friction or shock for use in primers.

To reload a primer, sharpen a nail to a tapered, slender point and press out the primer as shown in Figure 6-3. The nail must be thin enough to go through the flash hole. See Figure 6-4.

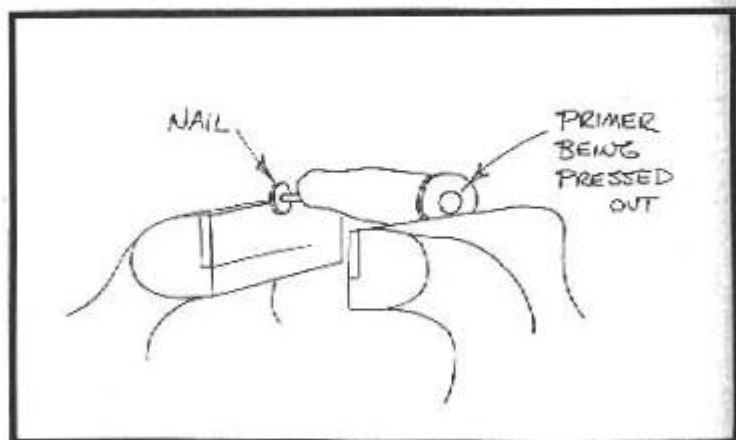

Figure 6-3

The spent primer of a rifle cartridge can be pressed out of the shell casing with a nail and a vise, as shown. The nail must be sharpened to a long, tapered point to go through the flash hole of the shell casing.

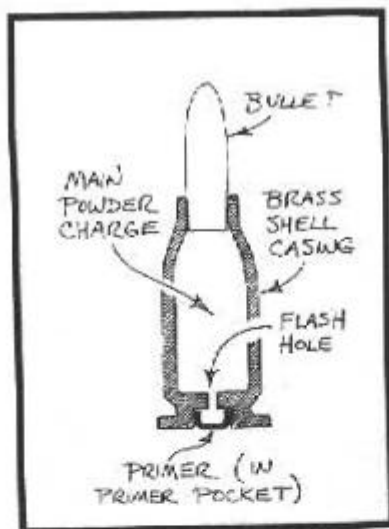

Figure 6-4

The general anatomy of a cartridge. Note the flash hole through which the nail must go to push out the old, fired primer.

Second, pry out the anvil and save it. Third, using a blunted nail, remove the dent from the primer cup as shown in Figure 6-5. You are now ready to pack the primer cup with primary explosive. To do so, you must first crush some match tips.

From three to five tips are required per primer. Primers vary in size (large rifle, small rifle, large pistol, etc.) and the amount of material deposited on the tip of the match during manufacture is not perfectly uniform from one match to another. The correct amount to use is enough to fill the primer cup level full with crushed material before tamping or compressing it.

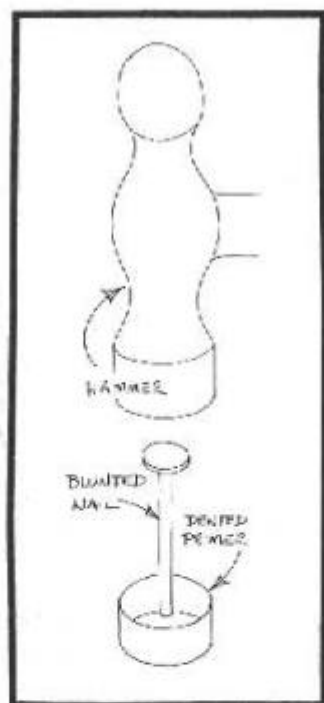

Figure 6-5

To straighten the dented primer cup, place on a hard surface and pound the dent out from the inside, as shown, using a blunted nail.

Some common sense safety procedures are in order. Always wear safety glasses, for example. Also, from time to time, a match tip will burst into flame while you are in the process of cutting it off the match head. When that happens, as it will, it is important that only the one tip ignites — that it doesn't fall into a pile of others previously removed.

To crush, place three to five tips on a sheet of paper on a hard surface. Make three piles. In one corner, keep the tips you

have not yet started to crush. That's your raw material. In another corner, keep the crushed-up powder you have just made. That's your finished goods. The actual crushing takes place in the center, one tip at a time. That's your work-in-process. See Figure 6-6.

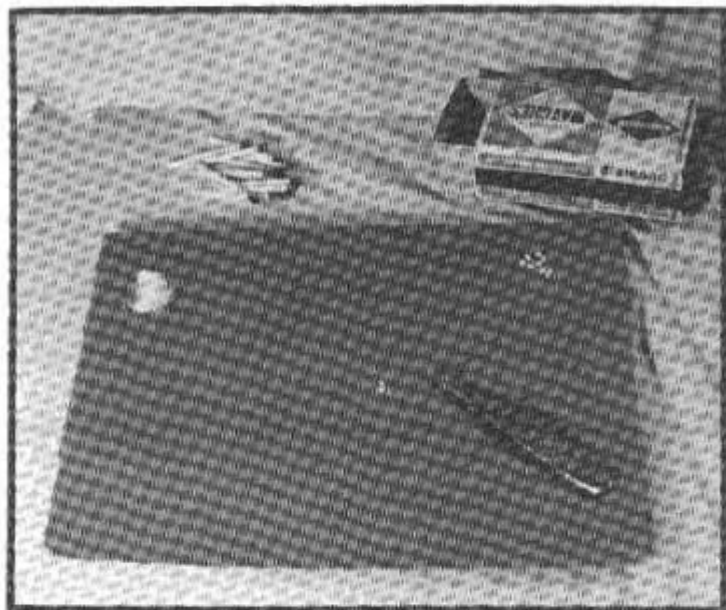

Figure 6-6

To safely crush match tips, use three piles on a sheet of paper. One pile is for tips not yet started and one is for the final product. The third is where the tips are being crushed or chopped finely, one at a time.

In crushing, use the cutting edge of a knife to cut each tip in half, then in quarters, then dice to a fine powder. From time to time a match tip will ignite, especially on the first cut when the

pieces are still large. If you work with three piles — raw material, finished goods, and work-in-process — the worst that can happen is that one tip ignites and burns a hole in the paper. The other way to do it, crushing several tips at once, is asking for trouble.

Use small pieces of paper for funnels, scoops, and pushers. When dealing with a very fine powder, some problems will be encountered with static electricity. Some individual particles will be repelled and you will have to chase them around to pick them up.

Fill the primer cup level full. Then use the rear end of a wooden match stick to pack down the primary explosive. See Figure 6-7. If you don't use a matchstick, use a non-metallic, non-sparking tamper as a substitute. Tamp gently at first, then push down with increasing firmness. Although the powder you are tamping is dry, it can be (and must be!) compressed to the point where none falls out when the primer cup is tipped upside down and tapped lightly.

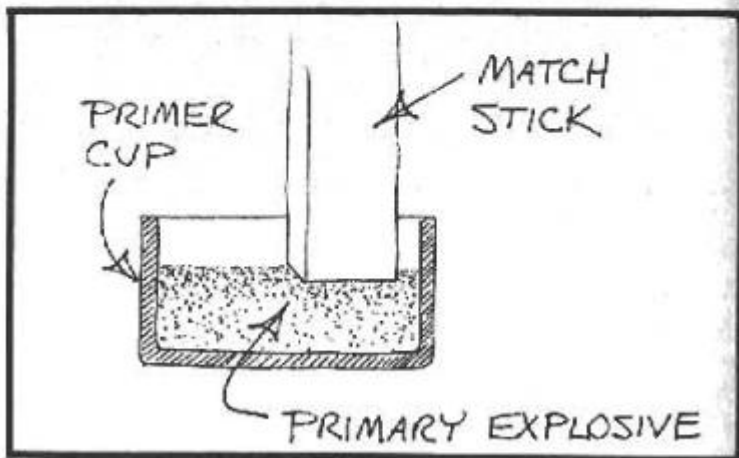

Figure 6-7

The crushed match tips are packed into the primer cup using the rear end of a wooden match stick or other non-metallic, non-sparking tamping tool.

The primary explosive in factory-made primers is coated with lacquer to seal out moisture. Although a dab of nail polish does not seem to interfere with ignition, I don't know how effective it is in sealing out moisture. Would it last ten years? There is no way of knowing, short of waiting ten years and testing it.

To reassemble the primer and cartridge, the anvil is placed not in the primer cup from where it came, but in the primer pocket in the cartridge case. See Figure 6-8. The anvil is placed in the primer pocket. Then the primer cup is placed in the primer pocket by hand, started with finger pressure, and seated with a vise as shown in Figure 6-9. You now have a primed cartridge case.

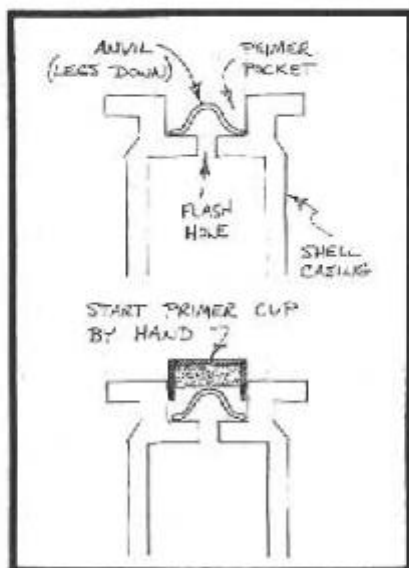

Figure 6-8

The primer and anvil are reassembled into the shell casing as shown. The anvil does not go into the primer cup, but into the shell casing "legs down." The primer cup is started into the primer pocket by hand.

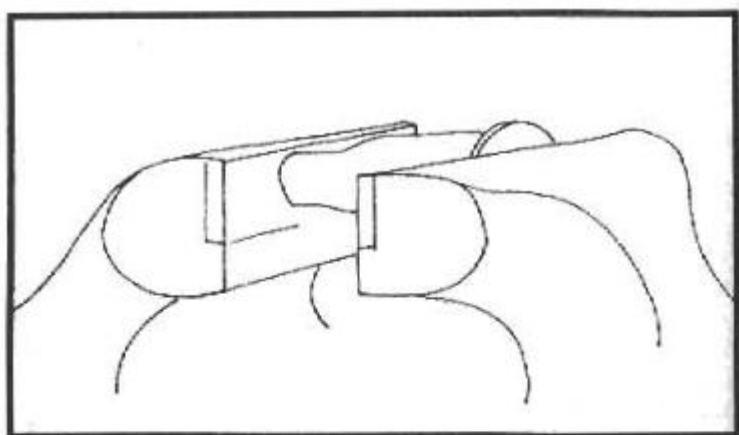

Figure 6-9

After starting the primer cup into the primer pocket by hand, it is seated by using an ordinary vise, as shown. Don't squeeze too hard and deform the end of the shell casing which is to receive the bullet.

A shotgun primer is slightly different. See Figure 6-10. The anvil must first be placed in the empty primer cup — it stays in place only by friction — and then the crushed match tips are first sprinkled in, then tamped in, around it. Reconditioning a shotgun primer is more difficult than is a rifle primer.

If you use a primer made from match tips in your gun, you must clean the gun afterwards. The residue from just one match tip is extremely corrosive. Were you not to clean the gun, within a week the bore would be coated with a thin layer of rust.

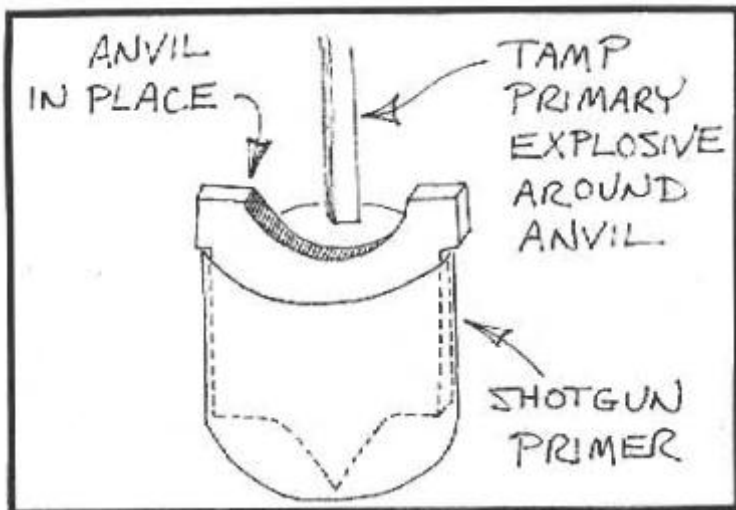

Figure 6-10

A shotgun primer is different from a rifle primer. With a shotgun, the anvil must be left in place in the primer cup (after removing the dent) and the primary explosive packed in around it. When reassembling, the "feet" of the anvil must rest on the "battery cup."

Other acceptable primers are Mercury Fulminate and Potassium Chlorate.

3. Cartridge Assembly

Next, a fresh primer is installed in the brass shell. It is started by hand with finger pressure, then seated flush as shown in Chapter 6, Figure 6-9.

Powder is then added to the primed shell casing. How much to use depends on the powder employed. For powder made from match heads, the amount to use is shown in Chapter 5.

For three other homemade mixtures (specifically potassium chlorate-sugar, sodium chlorate-sugar, and potassium perchlorate-sugar) the amount to use in a 12 gauge to achieve a killing load on rabbits is 1/2 teaspoon. The amount to use in other calibers is shown below as quantity "A."

For the saltpeter-sugar mixture, the amount to use in a 12 gauge is 1 1/4 teaspoons and the amount to use in other calibers is shown below as quantity "B." In some instances, the quantity of saltpeter-sugar mix called for might exceed the shell capacity as this is a very bulky powder. In these instances, simply load to the shell capacity.

For factory powders, load according to guidelines published in conventional reloading manuals. Manufacturers such as Speers, Hornady, and Lyman publish very complete reloading books. They are sold in gun stores.

If I were in a desperate situation and absolutely had to reload with factory powder and conventional, published reloading information was not available, I would use quantity "A," below. I would also remote fire any such load before shooting it in a hand-held firearm and I strongly urge you to do the same! See Chapter 3, Figure 3-50.

Remember:

Quantity "A" = the volume of powder to use when a 12 gauge takes 1/2 teaspoon.

Quantity "B" = the volume to use when a 12 gauge takes 1 1/4 teaspoons.

The figure given in parenthesis is the percent *by volume* of a 12 gauge load suitable for the caliber in question.

.22 *Hornet* (39%)

Quantity A: 1 1/4 teaspoons split into 6 parts

Quantity B: 1/2 teaspoon

.222 *Remington* (79%)

Quantity A: 1 1/4 teaspoons split into 3 parts

Quantity B: 1 teaspoon

.223 *Remington* (118%)

Quantity A: 1/2 teaspoon + 1 1/4 teaspoons split into 12 parts

Quantity B: 1 1/2 teaspoons

.243 *Winchester* (185%)

Quantity A: 1/2 teaspoon + 1 1/4 teaspoons split into 3 parts

Quantity B: 2 1/4 teaspoons

.30 *M1 Carbine* (48%)

Quantity A: 1/4 teaspoon

Quantity B: 1 1/4 teaspoons split into 2 parts

.30-30 *Winchester* (136%)

Quantity A: 1/2 teaspoon + 1 1/4 teaspoons split into 6 parts

Quantity B: 1 3/4 teaspoons

.308 *Winchester (7.62mm NATO)* (176%)

Quantity A: 1/2 teaspoon + 1 1/4 teaspoons split into 3 parts

Quantity B: 2 1/4 teaspoons

.30-06 (224%)

Quantity A: 1 1/8 teaspoons

Quantity B: 2 3/4 teaspoons

.375 H & H Magnum (264%)

Quantity A: 1 teaspoon + 1 1/4 teaspoons split
into 3 parts

Quantity B: 3 1/4 teaspoons

.44 Magnum (97%)

Quantity A: 1/2 teaspoon

Quantity B: 1 1/4 teaspoons

.45-70 Govt. (230%)

Quantity A: 1 1/8 teaspoons

Quantity B: 3 teaspoons

.458 Winchester (239%)

Quantity A: 1 teaspoon + 1 1/4 teaspoons split
into 6 parts

Quantity B: 3 teaspoons

9mm Parabellum (24%)

Quantity A: 1/8 teaspoon

Quantity B: 1 teaspoon divided into 3 parts

.38 Special (45%)

Quantity A: 1/4 teaspoon

Quantity B: 1 3/4 teaspoons split into 3 parts

.357 Magnum (79%)

Quantity A: 1 1/4 teaspoons split into 3 parts

Quantity B: 1 teaspoon

.45 ACP (82%)

Quantity A: 1 1/4 teaspoons split into 3 parts

Quantity B: 1 teaspoon

12 Gauge (100%)

Quantity A: 1/2 teaspoon

Quantity B: 1 1/4 teaspoons

16 Gauge (91%)

Quantity A: 2 3/4 teaspoons split into 6 parts

Quantity B: 1 1/8 teaspoons

20 Gauge (82%)

Quantity A: 1 1/4 teaspoons split into 3 parts

Quantity B: 1 teaspoon

.410 Bore (27%)

Quantity A: 1/8 teaspoon

Quantity B: 1 teaspoon split into 3 parts

I would like to stress that the above loads are derived on a calculated, theoretical basis. The 12 gauge loads have been tested and work as given. The loads for other calibers and gauges have been calculated from this and are theoretical. They are only intended to give a reasonable starting point for further testing. They should all be remote fired before hand held firing! See Chapter 3, Figure 3-50.

After remote firing, both the gun and the shell should be examined for signs of excessive pressure. If the breech plug is difficult to remove, for example, it probably indicates an overloaded situation where excessive chamber pressure has had a jamming effect on the threads. Look at the primer and compare it to an unfired shell. Excessive pressure inside the shell will have a swaging effect on the primer. With normal pressure the primer will look much the same after firing as before, except for being dented.

If you are concerned that a small amount of powder is rattling around in a relatively large case and may not be detonated by the primer, a piece of cotton fluff can be inserted after the powder and before the bullet. The fluff will hold the powder to the rear of the shell, against the primer for sure detonation. Don't overdo it. Too much wadding or packing can build up dangerous pressures.

Next comes the bullet. If you can purchase bullets, fine. If not, you can make your own. Lead is the best material, but mild steel — a nail or bolt of the right diameter and cut to the appropriate length — will work.

A bullet stays seated in a shell casing largely by friction. A sloppy fit can be improved with an aluminum foil or paper gasket. Some gentle squeezing with pliers can be done if necessary on the neck of the brass case where it grips the bullet.

From a safety and overloading point of view it is very important to use an appropriate bullet weight. Too heavy a bullet can dangerously increase the pressure within the firing chamber, even to the point of the gun exploding. The table below shows the bullet weight to use by caliber.

Caliber	Bullet Grains	Bullet Ounces	Bullets Per Lb.
.22 Horn.	40-45	.10	160
.222 Rem.	50-55	.12	133

.223 Rem.	50-55	.12	133
.243 Win.	80-90	.19	84
.30 M1	100-110	.24	67
.30-30	165	.38	42
.308 Win.	150-180	.38	42
.30-06	150-180	.38	42
.375 H&H	235-285	.59	27
.44 Mag	240	.55	29
.45-70	400	.91	17
.458 Win.	500	1.14	14

Pistols

9mm Para	100	.23	70
.38 Spec	150	.34	47
.357 Mag	158	.36	44
.45 ACP	230	.53	31

Shotgun Shot or Slug Weight

12 Gauge	-	1 oz.	16
16 Gauge	-	1 oz.	16
20 Gauge	-	7/8 oz.	18
.410 Bore	-	1/2 oz.	32

You can melt fishing sinkers and cast bullets in conventional bullet molds. Or, a wooden mold can be made as shown in Figure 7-2. Hardwood is best. It will scorch, but can be used several times. Lead can be melted in a pan on your kitchen stove. Solder will also work.

Cheap plastic diet scales can be used to check bullet weights, especially if the weighing is done in multiples. Your scale may not be accurate enough to weigh a quantity as small as .12 ounce, for example. But it will weigh one ounce with reasonable accuracy, and if eight equal-sized bullets weigh one ounce in total, then each bullet weighs about .12 ounces.

To summarize, the steps in loading a rifle cartridge are:

1. Remove the fired primer.

2. Install a fresh primer.
3. Load gunpowder in the shell.
4. Add a piece of cotton fluff if the volume of powder is small in relation to the shell size.
5. Install a bullet.

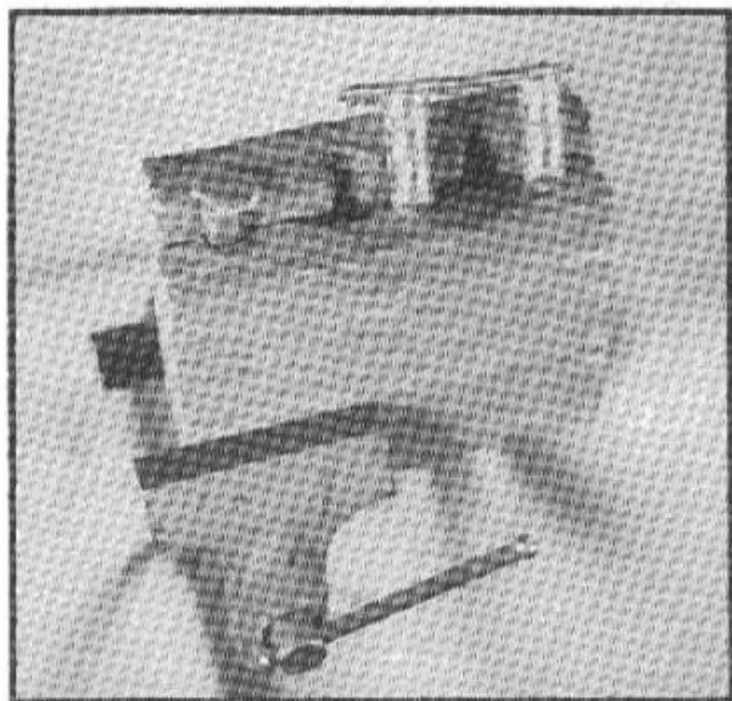

Figure 7-2

A homemade bullet mold. Two pieces of hardwood are clamped together and drilled to the correct diameter at the joint. Molten lead is then poured in the cavity. The bullet is removed by unclamping and pulling apart the "sandwich." The resulting slug must be trimmed and scraped to finished dimensions.

Shotgun Shells

Shotgun shells are more complicated to reload than rifle cartridges. The components are shown in Figure 7-3. They include the shell casing, the powder, the primer, the shot, and the wad.

The purpose of the wad is to trap the explosive force of the gunpowder behind the shot in such a way that the shot is expelled from the muzzle in a unit or lump. The lump of shot fans out on its way to the target, but leaves the barrel initially as a dense cluster, almost one piece.

To reload a fired shell, first remove the spent primer as shown in Figure 7-4. Next, replace it with a fresh primer. Start the new primer with finger pressure, then seat it with a vise and a length of wooden dowel as shown in Figure 7-5. Add powder as shown in Figure 7-6.

The wad is inserted next. If a conventional plastic wad is used, the mouth of the shell can be stretched by inserting and twisting a wooden rod carved to a cone shape. The wad is inserted by hand and seated with a dowel. See Figure 7-7. Be careful during these manipulations not to spill the powder which is already in the shell.

If a factory-made plastic wad is not available, a wad of paper can be used. See Figure 7-8. In a muzzle loader, a wad is used between the powder and the shot and a second wad is used after the shot to hold it in the barrel. A very similar system was used in early shotgun shells with one wad between the powder and shot and a second wad used to hold the shot in the shell. This same system could still be employed if need be.

Shot is added with a funnel. Substitutes for factory-made chilled lead shot are pieces of fishing sinker, lead collars from roofing nails, and old ball bearings.



Figure 7-3

Components of a shotgun shell. Clockwise from left: empty shell casing, factory-made plastic wad, gunpowder, primer, shot. The size shot pictured is #6 — the best all-round size for general hunting.

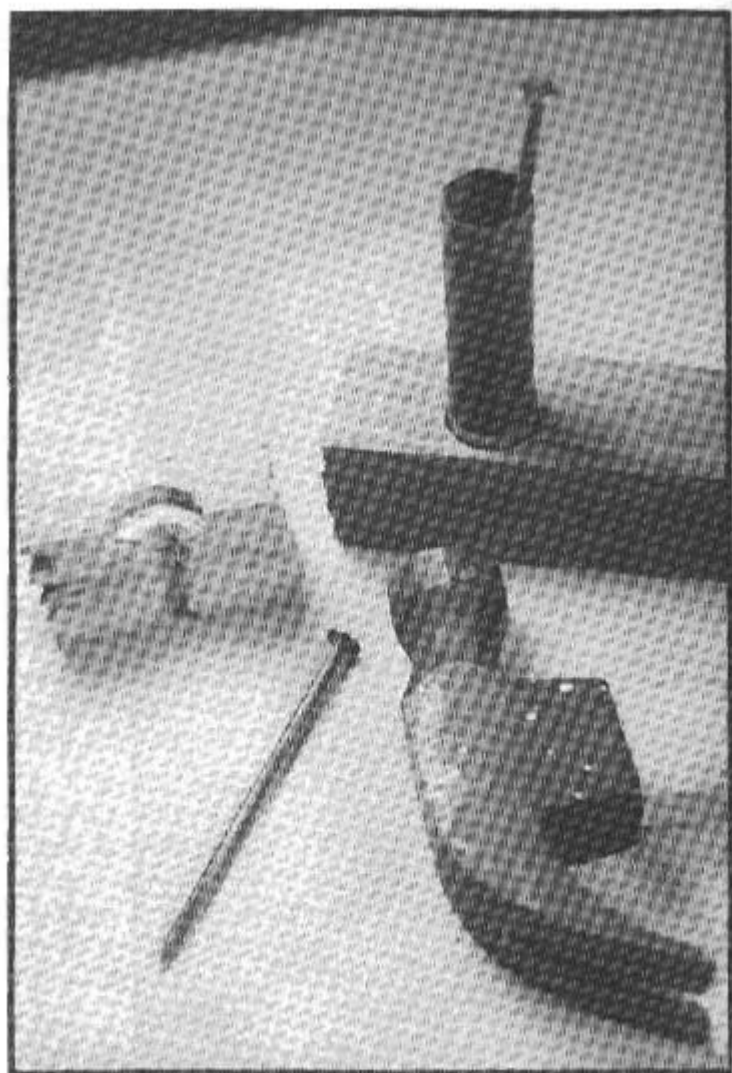

Figure 7-4

Removing a primer from a fired shell. The shallow hole is 7/8" in diameter. The smaller hole is 3/8" in diameter.

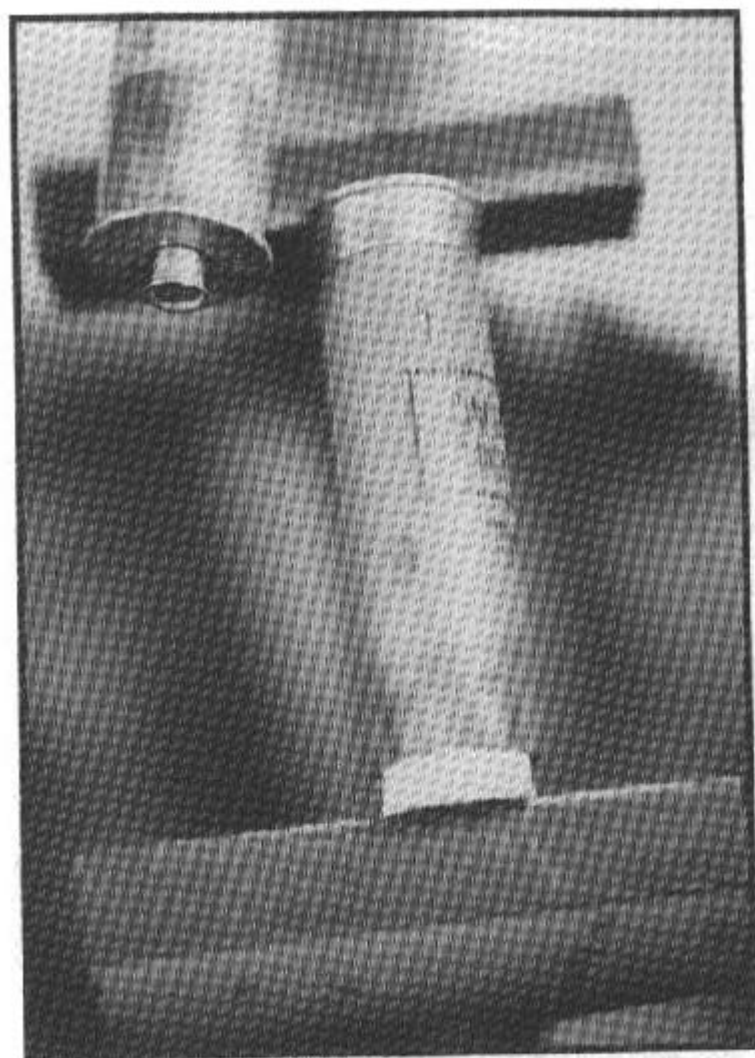

Figure 7-5

Seating a new primer. Start the new primer by hand with finger pressure (upper left). Finish seating the primer by inserting a wooden dowel into the shell and applying simultaneous pressure (with a vise) to the front end of the dowel and the rear end of the shell.

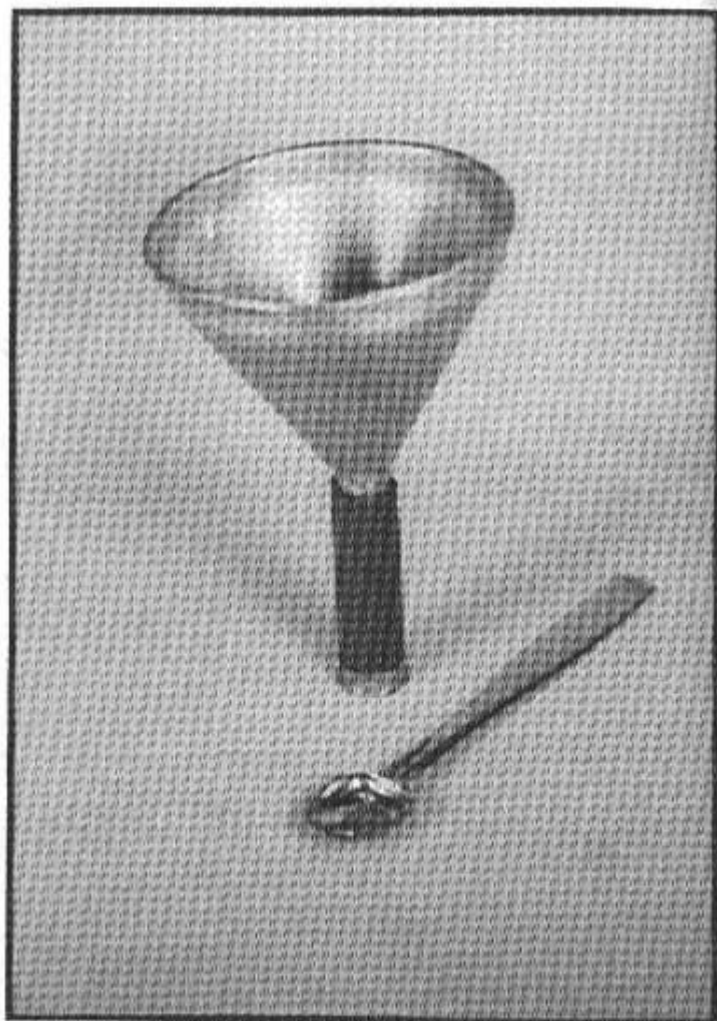

Figure 7-6

Add gunpowder to the shell with a funnel and a measuring spoon. Aluminum and plastic utensils are preferred because they are non-sparking.

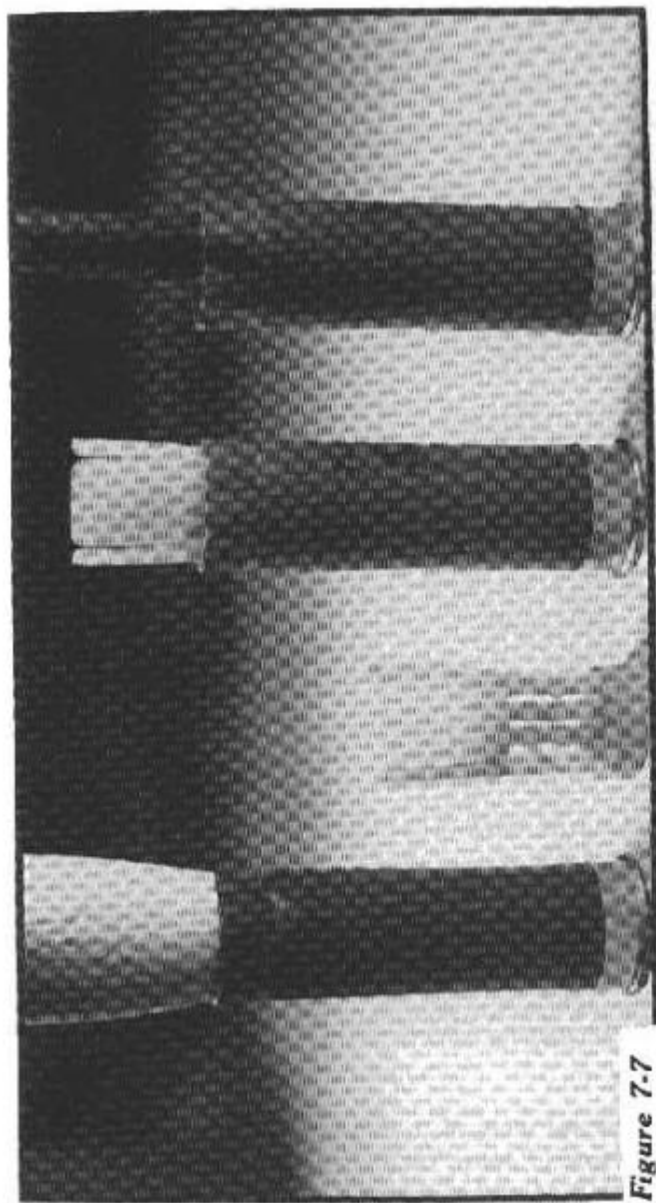

Figure 7.7

Putting the wad in the shell is a problem because of the crimp. The crimp can be spread, however, by inserting and twisting a tapered wooden dowel (far left). In sequence to the right is shown a commercial plastic wad; a wad inserted into the mouth, previously spread, of a shell casing; and a pencil being used to push down and seat a wad within the shell casing.

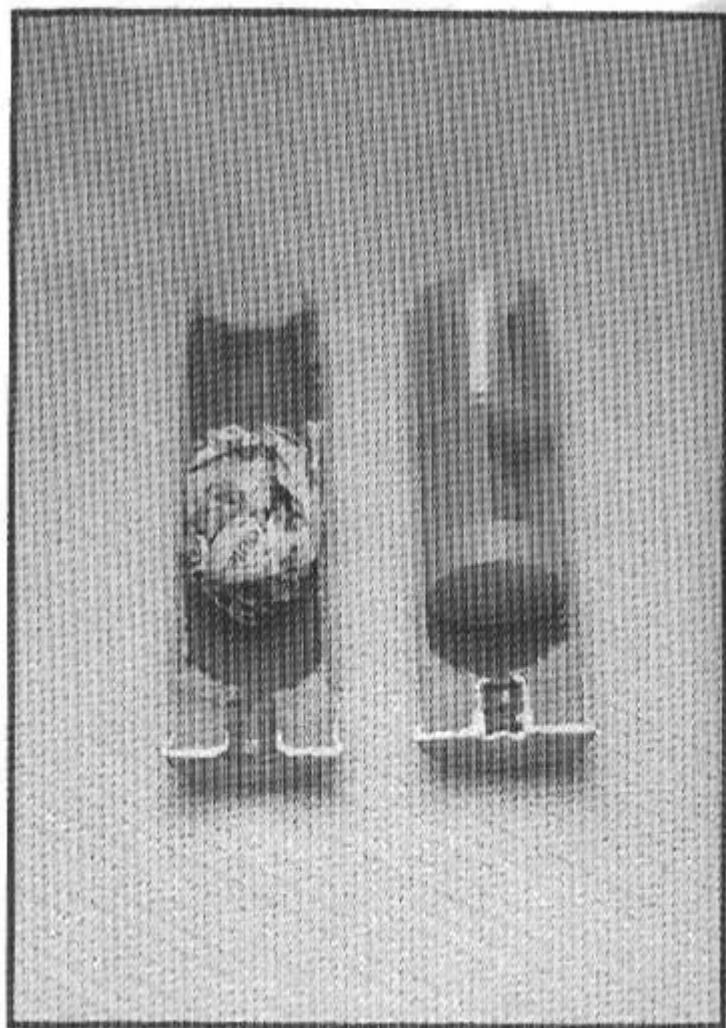

Figure 7-8

In this sectional view of a shotgun shell, on the left is a homemade wad of paper, on the right is a factory-made one-piece plastic wad and shot cup.

Recrimping the top of the shell with finger pressure only is difficult but can be done. Figure 7-9 shows actual shells which have been crimped with finger pressure alone. If the crimp simply won't stay in place but keeps unfolding, the mouth of the shell can be plugged up with a small ball of paper. The paper will prevent the shot from leaking out.

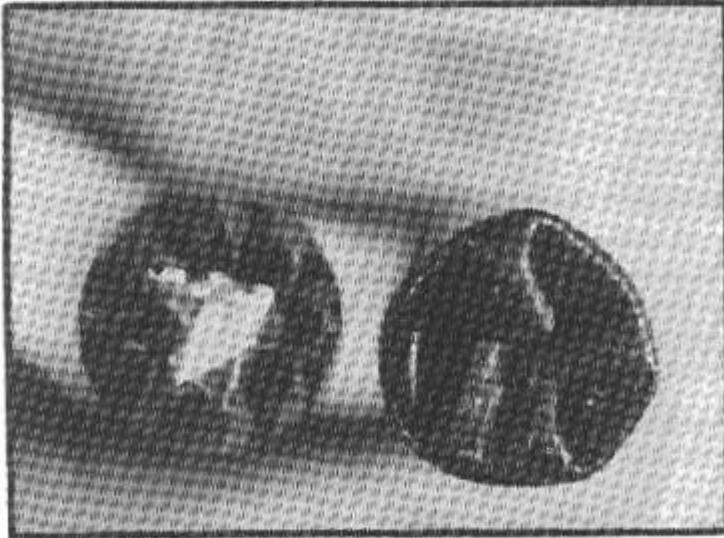

Figure 7-9

On the right is a plastic shotshell that has been recrimped totally by hand with finger pressure only. On the left is a shell which refused to stay crimped. A small ball of wadded up paper has been inserted as an overshot wad to stop the shot from leaking out. The crimp will hold the wad in place and the wad will hold the shot in place.

4. Casting your own Bullets

How To Cast Your Own Bullets
by Rich Stern

The bullet casting process can be easy, enjoyable, and in many ways, relaxing. It's also liberating. Have you ever had your eye on an unusual gun, but were put off by the oddball caliber and lack or expense of commercial ammo? No problem! When you realize you can easily and inexpensively make bullets for anything that shoots lead, you'll be buying that old warhorse in a heartbeat.

For those who might like to try bullet casting but don't know where to start, this is a basic primer.



Safety, safety, safety

We'll be dealing with molten lead alloy, as well as some other obnoxious substances (more on that in a moment). You must take care to avoid toxic fumes as well as minimize burn hazards. I do all my melting and casting outside, under a covered porch, with plenty of ventilation. I have a set of inexpensive tools dedicated to this process, and they get used for nothing else. If you have young ones around, you need to be even more cautious, because lead ingested by kids can cause harm to their developing bodies. Keep youngsters away from the casting process until they are old enough to participate responsibly. When done casting, clean up your work area so that nothing is left behind for them to get into trouble with.

Our society has demonized lead in the last thirty years. The government would have you believe you'll fall over dead at the very sight of lead. It's not as bad as that, but common sense is required. Wash your hands frequently, and always before you are about to eat or drink after handling lead. Avoid touching your eyes, nose and mouth while handling this stuff. If your clothes get contaminated during the casting process, change them before resuming your normal family and work routines. No reason to put other people in jeopardy for lead exposure just because it's part of your hobby.

Minimal safety gear:

- ☑ A work area with good ventilation; outside would be best
- ☑ Safety glasses (eyeglasses or range safety glasses will work)
- ☑ A pair of heavy work gloves
- ☑ A sturdy surface to hold your burner and lead pot
- ☑ Closed top shoes

Optional, but a good idea for some folks:

- ☑ Long sleeve pants and shirt
- ☑ Respirator mask

Sources of lead

Lead can be purchased from scrap yards, plumbing supply houses, and mail order companies that sell reloading supplies. However, the easiest source of lead for basic casting is used wheel weights, available by the bucketfull at any tire shop or auto dealership. Bring your own bucket, stop at the service manager's desk, and politely ask if they'd be willing to part with some used wheel weights. More often than not, they will gladly give you as much as you can carry. Some places may say no because of liability concerns or because someone pays them for the scrap metal. I've visited four tire shops in my area, all were happy to let me take as much as I felt like carrying.

Wheel weights are ideal for casting basic bullets. They contain a small amount of tin (about 0.5%), as well as antimony (about 5%). The tin makes the molten alloy flow better, and the antimony makes the alloy harder. Bullets made of wheel weights typically come out just right for moderate handgun velocities, and work well at modest rifle velocities if you add a gas check to the bullet. Casting experts have developed expertise in varying the alloys for different purposes. Specific amounts of tin and antimony can be added to create very different working properties for cast bullets, for specific uses. We'll leave the advanced metalurgy for the real experts. There are many resources on the Internet for such wisdom, and I've included a few references at the end of this article.

What you need to begin casting

The list of equipment is minimal, and actually rather primitive by the standards of our modern, digital age. After all, this process is hundreds of years old, and the equipment of yesteryear (a campfire, an iron pot, a ladle, etc.) still works.

You can buy equipment specific to bullet casting. Or you can go the economy route, as I did. The cookware section at the local Walmart provided most of my gear. Here's my list and what each item cost. As you can see, there isn't much investment to get started.

- ☑ Electric, single burner stove with variable temp control, \$9
- ☑ 1 quart aluminum saucepan, \$3

- ☑ Stainless steel condiment cups (used for molding ingots), 2 packs of 4 cups, \$1/pack
- ☑ 10x10 aluminum cake pan, \$3
- ☑ 3 pack, 10x10 aluminum foil cake pan (disposable kind), \$3
- ☑ Metal spoons, six for \$1
- ☑ Small ladle for scooping and pouring molten alloy (I use a Lee ladle from MidwayUSA), \$3
- ☑ Fluxing material: Used candlewax, old crayons, bullet lube, pretty much anything that is wax-based will work.
- ☑ A bullet mold (more discussion on mold selection a bit later). From \$16 to \$60, depending on type.

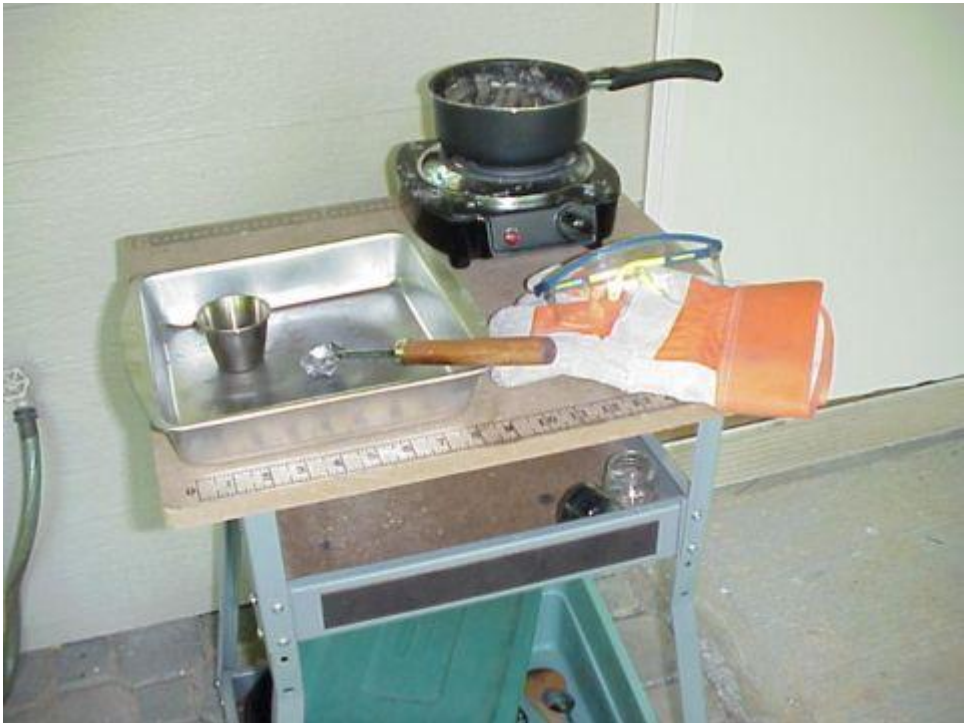

My basic setup.

Getting started

We'll start out by making ingots. While not absolutely necessary, it's a good way to clean your wheel weights, and get some practice pouring the alloy before we start casting bullets.

It is critical that you have good working space. Outside and covered is ideal. We need to avoid the fumes, and we also need to avoid having any water near our melting pot. You must make sure that no moisture comes in contact with the

molten alloy. A drop of water in the molten lead can cause a steam explosion, splattering molten lead all over you and anything else nearby. Water and molten metal do not mix!

Some people advocate washing the wheel weights before melting them down. Not necessary, in my opinion. All the crud is going to come off in the metal soup when we flux it, so leave it dirty. If you do wash the wheel weights, let them dry for several days. It all has to be dry when it goes in the pot.

For basic casting, use only the wheel weights that have the steel clips. The stick-on, adhesive backed wheel weights are pure lead; too soft for modern bullets. Save them for another day if you shoot black powder and want to cast your own muzzle loader balls, or you want to custom mix alloys by adding other casting metals.

Put about 5 or 6 pounds of wheel weights in the pot and turn the electric burner on full power. Go find something to do for 20 to 30 minutes. Come back every five minutes to check the pot, but don't hang around too long. The crud on the wheel weights (road grime, tar, dog piss, etc.) will start to burn off, and the smoke is about as foul as anything you'll ever smell. Reminds me of the New Jersey Turnpike, near Port Elizabeth. If you've been there, you know what I mean. Foul.



Melting down wheel weights...odors reminiscent of the New Jersey Turnpike.

Many casters use a lead thermometer to monitor the alloy temperature. I haven't graduated to that level yet. A good lead thermometer is \$30 or more, and being the cheap SOB I am, I don't want one. The 1100 watt Walmart electric burner needs to be left on high to keep 5 to 8 pounds of wheel weight alloy in liquid form. I just set it there and leave it. It's just hot enough for efficient pouring. For more advanced casting with harder alloys like Linotype (printer's lead), a stronger heat source is needed.

Once the alloy is molten, the steel clips and a whole lot of other crud will be floating on top of the mix. Skim it off with a spoon. Dump the skim into one of the baking pans. Remember, all this stuff is very hot, so handle it with care. Don't put it in the trash until it has cooled off. Once you've taken the debris off the top, you are left with a dirty soup of liquid metal, somewhat silvery in color, but with some black, ash-like stuff floating around. Those are impurities we will take out with flux.

Fluxing

Sounds far more complicated than it is. Simply put, we're dropping some wax (or bullet lube, or fluxing compound) into the mix. Its role is simple: Make anything that is not lead alloy stick to the flux material so we can easily scoop it out. Take a

few wax shavings, drop them in. It will smoke, and may even burn. Wait until the smoking stops, then slowly, but thoroughly, stir the mix with your spoon or ladle, scraping the sides and bottom of the pot. All of the gray, black, flakey crap that forms at the top, we want to try and corral and skim off. You should be left with nice, silvery looking molten alloy when you've finished fluxing. Don't drive yourself nuts seeking perfection on this step. There will always be some crud left on top of the mix. But it should be minimal. More will show up later, and you can flux again anytime you feel it is worth getting more crap out of the mix. Small amounts of impurities won't hurt the mix, but we don't want chunks of garbage in there, either.



Clean alloy, ready for casting into ingots or bullets.

Pouring ingots

With nice, clean wheel weight alloy in liquid form in the pot, it's time to pour some ingots. Take the stainless steel condiment cups and place in one of the cake pans, on a level, sturdy surface. Make sure that whatever surface you use will stand up to the heat. The alloy is somewhere between 625 and 700 degrees, and will apply considerable heat through the cups to whatever they are resting on.

With your gloves on, pick up the pot and pour the molten alloy into the cups, until they are about 2/3 full. Pour carefully to avoid spills and splashes. Let the cups sit undisturbed for about two minutes, so the alloy can harden. After that, you can

pick up the pan and move it if you are concerned about where it is resting. I usually put it on the ground (concrete) after the lead has returned to solid form. The ground helps dissipate the heat more quickly.



Ingots in their "molds" after pouring and solidifying, moved to the ground and left to cool.

You can buy a fancy ingot mold for \$10 to \$20 so your ingots say "Lyman" or "Lee" but I'm not terribly interested in having someone else's name on something I made.

After about ten minutes of cooling, with your gloves still on, turn the cups over and gently tap them. The ingots fall right out. They will still be hot, and so will the cups, so be careful handling them. After about 20 minutes, they are cool enough to handle. Here's what you get:



Filling the condiment cups about 2/3rds full results in convenient, 1 pound ingots.

Now we have nice, clean, nearly pure lead/tin/antimony alloy ingots that are perfect for casting bullets, in a handy size, easy to store, and easy to melt. A pound of nicely cast wheel weights goes for about a buck on eBay, so if you really want to go to town, you can sell your excess ingots for a little cash.

We're ready to cast bullets.

Casting bullets

You'll need one or more bullet molds, based on the caliber, weight and style of bullets you like. Bullet molds are available from many online sources like MidwayUSA, Brownells, Midsouth, etc. Used molds can be found on eBay. There are two major types of molds: Aluminum and iron. I have several Lyman iron molds, and they work very well. I also have some Lee molds that took me a while to get the hang of; once I mastered using them, I started to produce some nice clean bullets. Aluminum and iron have different casting properties and dictate slightly different approaches to casting, and involve a small learning curve. The molds commonly come in single, double, quad and six bullet configurations, which impacts how quickly you can cast bullets. Some of the bullets will be improperly formed rejects. They just go back into the pot for another try. The molds have to heat up to produce good bullets, so it may take some practice casts until you get good bullets.

Lee molds are inexpensive, typically less than \$20 for a two cavity mold, and should last for 10s of thousands of bullets. The iron molds, properly cared for, can be passed to your grandchildren. Unless you abuse them, they don't wear out. Lyman sells rebuild kits that contain washers and screws, for replacing the parts that most likely will wear out before the mold.



A Lee double cavity mold on the left show with its sprue open, and two Lyman molds, a double and a single.

Each mold needs a handle (some molds come with handles, others require they be purchased seperately). The sprue plate is a hinged plate with a hole for each mold cavity, through which the molten alloy is poured. When the alloy has solidified, the sprue plate is opened, which cuts the excess lead from the base of the bullet. The mold is then opened and the bullets should fall out, or fall out with a gentle tap from a block of wood. It's best to have a piece of cotton cloth for the bullets to land on, or the aluminum foil bake pans can be used. The bullets are just below molten temperature when they come from the mold, so they are soft and can be dented easily. Some casters drop them into a bucket of water (with all of the safety caveats that come with such a practice...remember what I said about water near the melting pot). This is called quenching, and produces a considerably harder bullet than just air cooled bullets. Most shooters will be well served with air-cooled cast bullets, but if you want harder bullets, quenching is an easy way to get them using wheel weights.

The process isn't much different than the ingots we just poured. Follow the mold manufacturer's directions for mold prep, which may involve lubricating parts of the mold, and smoking the mold with the smoke from a lighter or matches.

When your lead alloy is molten, scoop some into your ladle and pour it into the mold until a puddle forms on top of the sprue hole. Wait until it hardens, about 3 to 5 seconds, then open the sprue plate and drop the bullets out. Sometimes a tap from a wooden dowel is needed to free the sprue plate or get the bullets to drop out of the mold. With some experience, you'll learn how to efficiently do all of these steps. Close the mold, pour more alloy in, and keep it up until you have the quantity you want. Keep an eye out for poorly formed bullets, which could indicate problems with alloy or mold temperature, or foreign debris in the mold. The mold has to heat up to a good working temperature before you get consistent results, so your initial casts may produce quite a few rejects. You can put those back into the pot. Be careful not to splash molten alloy on yourself or your work area. A few minutes on prep will minimize the number of rejects.



Some of my cast bullets: .314 rifle bullets on the right, and .357 wadcutters for my .38 special.

Sizing, Lubricating

After casting, one or two operations remain. We may have to size the bullets. This depends on a couple of things: The size of your gun's bore, and the size of the

bullet the mold casts. If you can fit a bullet into a case without bulging the case, it does not need to be sized. For example, the .314 caliber wheel weight bullets from my Lyman 311495 mold fit into a flared .303 British case. My Enfield's bore size is .312. A cast bullet that is .001" to .002" greater diameter than the bore is good. If the bullet is undersized, the bullet may not fully engage the rifling, resulting in poor accuracy. If the bore is too small, the bullet may generate excess pressure and leave lead in the barrel. Lee makes inexpensive sizing dies that cost about \$12/caliber and work with any reloading press that takes standard dies. Lyman, RCBS and others make more sophisticated, one step lubricating/sizing tools, and these are often preferred by casters who want the finest. The Lee dies work. The sizing step is also good time to put gas checks on bullets intended for high velocity loads. A gas check is a small metal cup that fits around the end of the bullet. It is typically press fit at the same time the bullet is pushed through the sizer die. The gas check protects the bullet from the high pressure and heat of the powder burn, and reduces or eliminates barrel leading that would otherwise occur at high velocities.

Lee sizing dies come with a liquid bullet lube that is easy to apply. You put the bullets in a plastic tub, add the lubricant, and tumble the bullets around until they are coated. You then set them out on wax paper overnight to dry. Cast bullets must be lubricated, or they will leave lead in the barrel of your gun, making cleaning a real bear.

That's basically it. Advanced bullet casting is simply additional detail or processes on top of what I've described. Using the above info, you can experiment and custom match bullets to your guns for excellent accuracy.

Regarding the bullet mold: you can make your own bullet mold by welding two half molds to a pair of garden scissors (make sure it closes flush to one another). To make a half mold, design a valid bullet shape. Now sand, mill or lathe one end of a bar of steel until it is exactly the shape of the bullet you want to make. This will require great precision, so allow yourself time and measure frequently. Next heat up a block of steel with a blowtorch until it is white hot (just before it melts). Press the cold steel form into the hottest area until it is exactly half the way in. Use a wooden block at the exact height of one half bullet below the edge of the heated block to hold the rest of the bar, this will aid in getting exactly half. Immediately remove the steel bar and allow the steel block to cool. Measure the indentation. If you pressed too deep or shallow then try again elsewhere on the mold until successful. Melt down the entire block into a new ingot if you repeatedly fail. Repeat the process for the other half mold. Remember: the tolerances for the bullet are very precise, if you need a perfect mold then try pressing the bar vertically into the heated area and cutting the entire block in half in the middle of the bullet casting hole. Another method is making a clay bullet and pouring the ingot around it. Remove the hardened clay with a chisel after cooling. For more tips on CNC machining, mold making and resin casting see: <http://camtuf.coredump.cx/gcnc/>

Bullet designs and parameters are available online.

5. Cartridge Cases

Now you have knowledge of how to produce the primer (correctly sized cup + powder + anvil), bullet (correctly sized bullet mold + bullet die for resizing), and propellant. The final piece of the puzzle, and arguably the most difficult, is the casing. The calibres covered in this guide are .38 special, 9mm Parabellum, .22, 5.56 NATO, 7.72 NATO. You can find the exact dimensions of other bullet casings online.

The case is the "bottle" that holds the bullet (the "cork" if you will) at the front, the powder inside that powers the bullet on its trip down the barrel, and the primer in its base that sparks the burning of the powder when it is dented by the firearm's firing pin. The case not only holds everything together, it forms a gas seal crucial to the shooter's comfort and safety when the arm is fired. The high pressure generated by the expanding gasses released by the burning powder when a gun is fired cause the case to expand slightly, tightly sealing the chamber and preventing the blow-back of gas toward the shooter. The concept of the case is what made single chamber repeating firearms practical and immensely speeded reloading.

Cartridge cases have been made from copper, mild steel, aluminum, and brass. It is the latter case material that is the most durable and the only type of case that is normally reloaded. Brass is a metal alloy composed of approximately 70% copper and 30% zinc. Brass is non-magnetic so, if necessary, a magnet can be used to separate brass cases from steel cases (which are often given a copper or lacquer coating to prevent rust).

Brass cartridge cases are formed from a round disc (called a "blank") of metal that is drawn to its ultimate shape in a series of steps.

The only way to harden brass is to deform it. This means that to get the head portion hard enough to withstand firing pressures in a modern high powered rifle cartridge, it has to be worked into shape. The exact amount of working is a critical part of the manufacturing process, and the front portion of the case is less worked, so less hard and the neck/shoulder area is heated to remove hardness (anneal).

If you cast a case it would be annealed everywhere (dead soft) and even if it was dimensionally perfect, it would be dangerously weak. Forming from another caliber brass is the only practical way for the amateur to make his own cases. The only way to get the proper grain

structure for brass cases is to draw the brass cups into the case shape with some annealing between steps. Machined brass will not have the proper grain structure no matter what you do to it and will only be good for a few very light loads.

Case Material

Brass:

The vast majority of 9mm (and other) cartridges produced since 1902 have had cases made of brass. The brass cases have sometimes been plated with brass or nickel for identification, or appearance or to make them more durable.

Rimfire

Rimfire cases start as rolled, thin sheets of cartridge brass, which are mounted and fed through rollers to reflatten them.

The sheet moves into a cupping press that

- lubricates the sheets,
- blanks out disks of brass,
- drives the disks into a cupping die to form shallow cups.

A draw press reduces the diameter and increases the length of the cup in the same manner as copper bullet jackets. The punch and die set in the draw press captures all surfaces of the cup except the base (closed end) and stretches the brass to the desired diameter. The drawn length is longer than that required for the finished case to allow trimming the case mouth to uniform length. The inside of the case mouth may be beveled during trimming to facilitate bullet seating.

At this point, the case has a finished diameter and case mouth, but the closed end is not shaped into a functional case head. The [heading operation](#) shapes the closed end using a press called a [header](#).



Rimfire headstamp - Airline brand

Image courtesy of Federal Cartridge Corp.

Heading accomplishes the following:

- Forms the rim and rim cavity (for holding the [priming charge](#))
- Sets the rim diameter
- Sets the rim thickness
- Sets the final case length
- Applies the identifying [headstamp](#)

In most factories, all of the heading processes can be accomplished in a single operation. The case is held securely in a stationary die; an inner back-up punch and an outside forming punch come together to apply the required force. The outer punch ([bunter](#)) has raised characters on the punch that impress the headstamp into the base.

After cold working, the brass may have residual stresses, which may affect the long-term performance and safety of the case. This contributes to [age hardening](#). Stress relief ovens raise the metal temperature enough to relax the stresses without changing the grain structure of the case.

The rimfire case is fully formed, but covered in oils that could contaminate the priming compound. Washing removes these oils, leaving water in its place. The cases must be oven dried to remove all traces of moisture.

Centerfire

Similar to rimfire cases and metal bullet jackets, most centerfire cases start as cups. Since the raw sheet brass required for these cases is often thicker than that used for rimfire cases, preformed cups are frequently purchased by the manufacturer.



Cross section of a cartridge case, Image courtesy of Federal Cartridge Corp.

Drawing is the most widely used method in the manufacture of brass cases. It reduces diameter and increases length and is the best method for case fabrication. There is little difference in tooling between case-drawing dies and those used to make bullet jackets.

Depending on the length of the finished case, the cup may be drawn from one to five times. For cases requiring three to five draws, an intermediate stress relief heat treatment may be applied to keep the material ductile. The dies and punches maximize the diameter and length and fully shape the cavity. This profile defines the wall thickness of the finished part. The case will be thinnest at the mouth to allow flexibility for holding the bullet. To withstand firing pressures, the walls will be thickest at the closed end.

Drawing Operations

The draw operation leaves enough material in the base to form the [web](#) of the case. The web provides support for the primer and reduces the amount of swelling that can occur during [firing](#).

After drawing, the cylinder is closed at one end, leaving extra material in the closed end. That end is [convex](#) after drawing; the draw dies work only the metal in the walls of the case. The next operation flattens the base, squaring it and applying the head stamp.

Heading also forms the rim for a rimmed case or removes the excess material when creating a rimless case. Heading forms a primer pocket in the web. The cylindrical case is mounted in a die to prevent changes in diameter; a support punch is placed inside the case to resist the blow of the bunter. The bunter has a central protrusion that will form the primer pocket (the recess that accepts primer during cartridge assembly).



Bunter to form primer pocket and headstamp, Image courtesy of Speer, Inc.

If the case is to have a protruding rim (e.g., 30-30 Winchester), the supporting die requires a step in the end facing the bunter. The step allows all of the extra metal to flow toward the end and creates the mass of material that will eventually form the rim. The die that supports a rimless case (e.g., 5.56 mm NATO) has a slight enlargement at the exact same point. This enlargement provides that there is plenty of extra metal to ensure that subsequent operations keep the case head concentric.

Head-Turning Operations

The next operation finishes the exterior shape of the case head. Head turning is performed in a small automated [lathe](#), with the cutter blade mounted at ninety degrees to the long axis of the case so that it can create all needed surfaces in one pass. When the factory switches from producing 30-30 Winchester cases to manufacturing 5.56 mm NATO cases, the cutter is changed to meet the new specifications.



Collets

The head turning machine grips the cases in a [collet](#), a hollow die with longitudinally split walls that can grip and release a round object. When the case is fed into the machine, force is removed from the collet, allowing it to accept the next case to be processed. As the case seats, the machine applies pressure to the collet forcing it to firmly grip the case. The case and collet spin to high speed before the cutter touches the case, ensuring a clean accurate cut. The collet opens and a punch dislodges the case. Good head-turning machines will process 60 to 120 cases per minute.

Some head turning machines can also drill or punch the [flash hole](#), which is the hole that allows fire from the primer to reach the propellant charge. If the case will be loaded (as opposed to being sold as a component), the maker will probably punch the flash hole in the case just before the primer is inserted on a device called a pierce-and-prime machine.

Taper, Trim, and Neckdown

After head turning, the case is slightly longer than the finished product and is a near-perfect cylinder. Most cases are ultimately tapered to some degree. The case is run into a die. If a small taper is needed, one die can suffice; for more pronounced tapers, the taper is produced progressively to reduce stresses.

Many rifle cartridges have a distinct bottlenecked shape. The neck and shoulder that create the bottleneck shape are also produced in a die or in a series of dies (if the neck diameter is much smaller than the case body).



Bottleneck cartridge case

Once the final profile is formed, the case is trimmed to the specified length. Trimming can be performed on a machine with a cutter that is moved to work the open end of the case (similar to the head-turning machine). Trimming can also be performed in a machine with a rotating cutter; the cutter axis aligns with the case axis. It moves down onto the case mouth, and a preset stop halts the cutter when the correct length is reached.

Stress Relief, Annealing, and Hardness



Split neck cartridge cases

Residual stress from the forming operations can affect both rimfire and [centerfire cartridge](#) cases. For many cases, especially those with bottlenecks, the stresses are so great that high-temperature annealing must be used.

After forming, a bottleneck case may appear perfectly serviceable. However, massive stresses are likely to remain in these areas. If the ammunition is loaded and stored without addressing these stresses, cracks can appear in the bottleneck area.



7.62 mm NATO cartridge

Case bottlenecks are normally flame-annealed by the following process:

- Placed on a moving rail or rotary disk system, the case passes before a set of gas burners that rapidly heat the neck and shoulder area to glowing.
- As the case becomes incandescent, the brass grains grow larger.
- The heated area of the case is immediately tipped into a water bath to quench the case, establishing the large grain size.
- The treatment causes a dark, but harmless, discoloration to the neck area. In commercial ammunition, this dark area may be polished out for cosmetic reasons; in U.S. military ammunition, the discoloration remains visible.
- The application of heat treatment technology to vary the grain size gradually, from small grains in the head area to large ones at the case mouth, determines case hardness.

All high pressure cases must have variable metallurgical properties depending on the part of the case, as follows:

- Head - must be tough and relatively unyielding, small brass grains contribute to the toughness.
- Body - the case walls must combine flexibility and strength to contribute to the obturation system.

- Mouth - must be softer (larger brass grains) to prevent cracks from the strain of holding a bullet.

Alternate Materials



Cartridge with aluminum case, Image courtesy of CCI Ammunition

Brass is the most commonly used material in the production of the modern cartridge case. Mild steel cartridge cases and bullet jackets are manufactured outside of the United States. Another alternative material is aluminum alloy, which is used to produce centerfire cartridge cases. Other materials, such as plastic, have been tried but have not been widely accepted.

Making ammunition from brass pipes

Making ammunition does not have to be so difficult. Achieving different calibres for the casing is as simple as finding brass tubes or pipes and accomplishing the job on your bench vise. To reduce the tube place the piece of tube on one end of a die and squeeze away. Keep in mind that it is best to reduce it multiple times if the



difference in diameter is large. Or you can reduce small quantities of brass tube by swaging it down in a collet. To expand the tube try driving a piece of tube over a tapered or straight mandrel. You draw the brass tube at a shallow angle over the end of the mandrel to stretch it. This is not foolproof - there is some skill involved. Alternatively you can use graduated dent balls which can be pushed or pulled through the tubing to expand it. The graduated balls avoid any problems with roundness; you can thread one and put it on a rod with handle for ease of control, and it would be easy to make balls in sizes appropriate for the job as needed. Usually the graduated balls come in sets with 0.005" increments, making them highly useful to measure internal diameter. Make sure the wall thickness when reducing or expanding it, does not become too thin. Having it be slightly thick is acceptable as long as the external diameter still matches the required calibre, also adjust the size of the rest of the components. Tapering the case is achieved best through using a short tapered mandrel or make a die by boring a piece of steel with the correct taper for the outside of the finished tube. Make sure you know the angle of the taper so that it reaches correct diameter over the correct length.



Making .38 Special Cartridges

Remember that this method works equally well for other calibres as long as you adjust the material and follow the alternate dimensions.



MATERIALS REQUIRED

- 1) *Brass tube.*
- 2) *Curtain rings.*
- 3) *Solder paint.*
- 4) *Tube cutter.*
- 5) *Vernier gauge.*
- 6) *Gas torch.*
- 7) *30 x 30mm Square tube.*
- 8) *Hardwood section.*
- 9) *Attention to detail.*

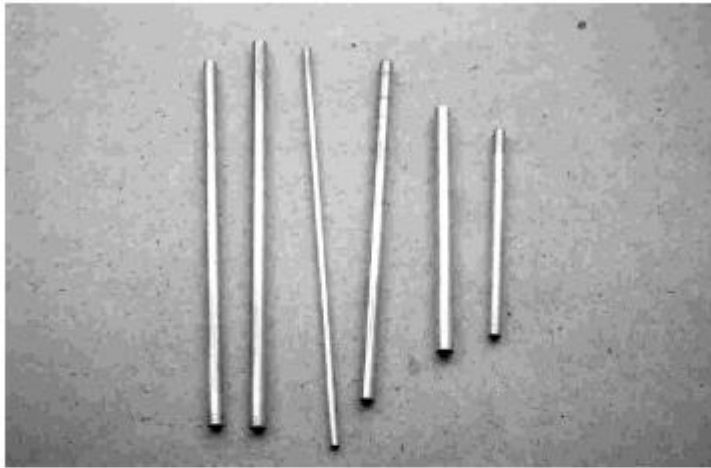

We will start by manufacturing .38 Special cartridge cases.

The .38 Special is one of the most popular revolver cartridges in the world, supplying ammunition to a countless array of handguns, so it seems the appropriate cartridge to start with.

To manufacture our homemade .38 cartridges we require some lengths of thin walled brass tube. This material is readily available from most good hobby and craft shops. The tubing I am using is manufactured in the U.S.A. For the various calibre of ammunition we will construct in this book we require tube in the following sizes;

15/32" - 13/32" - 3/8" - 7/16" - and 11/32".

For the .38 cartridge case a length of 3/8" tube is required. The vernier gauge is set to 30mm, and as shown in the photos below, used to scribe a line around the tube. This is achieved by simply rotating the tube against the sharp point of the gauge.

This section of tube, measuring 30mm, is now removed. The scribe mark is the point at which the tube is cut. Brass tube is harder to cut than ordinary copper plumbing tube so a good quality plumbers tube cutter is required. I emphasize 'good quality'. It is perfectly possible to buy a good quality cutter for around £10. It is well worth spending an extra few pounds as it will make tube cutting an easier prospect.

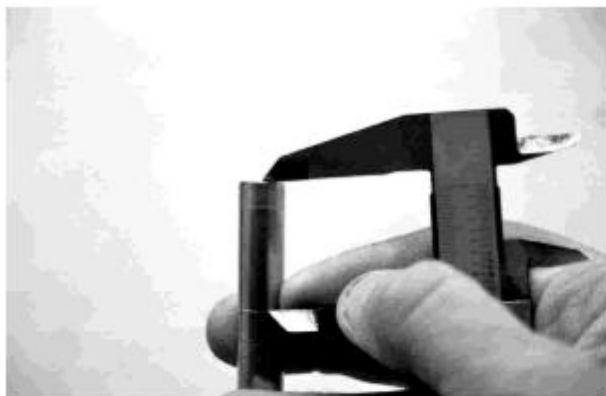

Mark the tube.

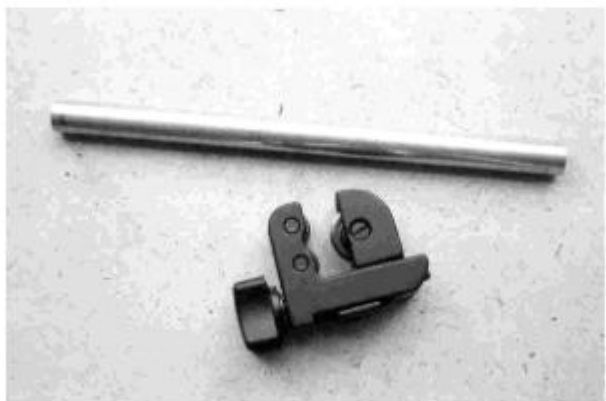

Cut the tube.

The tube cutter should be carefully rotated clockwise and anti-clockwise so as to allow the section of tube we require to be removed. It is important not to rush the tube cutting procedure as this may cause the cutting wheel to wander leading to an inaccurately cut case.



Square the case end.

It is of *great importance* to ensure that one end of the tube section (from here on referred to as the case) is perfectly square. To achieve this the case is placed in a drill press and the spinning case lowered onto a flat file, as illustrated in the above photo. It should be noted that the drill chuck should be tightened by hand only so as not to distort the roundness of the case. This method of case trimming is just as accurate as using a small lathe and no different in principle to the case trimmers used in conventional re-loading practices.



Measure the case.

Following the trimming operation the case is measure to ensure it has an overall length of 29mm. The correct case length is very important.

ATTACHING THE CASE RIM



Soldering materials.



Case rims

Now that we have the main body of our .38 case it is necessary to attach the case rim. To achieve this we require a small 'micro' pencil gas torch, a 3/8" curtain ring, and some solder paint. Solder paint is a mixture of flux and powdered lead solder.

The .38 case rim consists of a 3/8" curtain ring. These can be found in most good hobby and craft shops and usually have 'Rings and Clips' printed on the pack. The clips should be discarded as they are not required. It is very important to make sure the rings have an inside diameter of 3/8".



Apply the solder.

A matchstick or small artists paintbrush is used to apply a small amount of solder paint to the *squared end of the case*. Ensure that the solder is fully covering the circumference of the case.



Solder the rim.

The ring is now placed in the centre of a section of steel rod, around 1" in diameter, as shown above. The painted end of the case is then inserted into the ring. It must be ensured that the case is inserted fully and the end of the case resting against the top of the rod. The pencil torch is now used to solder the ring to the case. Only a small amount of heat is required to melt the solder so it is important not to "over do it". Allow the case to cool for thirty seconds or so and then carefully remove the case and place it to one side while the next case is soldered.

CASE CLEAN UP



File the base.



De- burr the case.

As illustrated above, the case must be passed back and forth across the surface of a file several times to remove any solder residue. The inside of the case mouth must also be completely de-burred using a knife.



A collection of finished cases.

For the simple manufacture of moderate quantities of .38 cases, the tube and ring method is perhaps ideal for the hobby gunsmith. Once the necessary quantity of tube sections are cut and trimmed to their correct length, cases can be manufactured quite quickly.

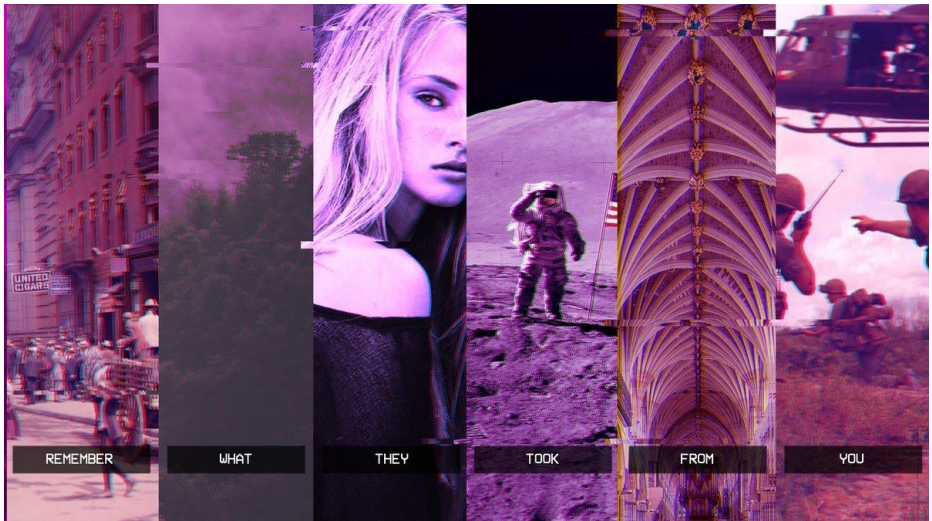

THE SHELL HOLDER

Before our newly primed cases can be charged with powder it is necessary to make a simple shell holder. To make the shell holder we require two washers. Both washers are 1" in diameter. One washer must have a $\frac{1}{4}$ " hole and the second a $\frac{1}{2}$ " hole. The two washers must be soldered together and for this we require some solder paint and our gas torch. Again, I am using a pencil torch due to its small size and more accurate flame. The photo below shows the complete shell holder and a handmade .38 case ready for loading.



Shell holder materials.



Washers ready to solder.

Before the washers can be soldered together the zinc surface should be removed by simply sliding the washers over a file several times.

To solder the two washers together place the washer with the ¼" hole on a flat surface and apply solder paint to it's circumference. Place the second washer (½" hole) on top of the first. Apply heat to the washers until the solder runs. Now leave the assembly to cool. If, as sometimes occurs, the washers 'slide' out of alignment with each other during soldering, the washers may be soldered on a wooden board and four tacks may be used to hold the washers in alignment. Simply place a tack at the 12, 3, 6, and 9 o'clock points around the washers. The wooden surface allows the tacks to be pressed in by finger pressure only and permits their easy removal after soldering. The small amount of heat required will not burn the wood unduly but it's best not to use the best dining room table !



Soldering the shell holder.

In the above photo I am soldering the washers together on top of a section of steel tube, but as pointed out earlier, it is sometimes easier to use the board and tack method. The purpose of the shell holder is to protect the primer in the base of the case from coming into contact with any object that may cause the primer to detonate unintentionally. It is of great importance when reloading ammunition and although it is a very simple component it's importance should not be overlooked.

The photo below shows the finished shell holder and case ready for loading with powder and bullet.

The next step is to resize our bullets ready for loading.

BULLET SIZING DIE



The bullet sizing die.

I am using commercially available .38 bullets for my improvised cartridges simply because they are readily available, but even if they were not a bullet mould can easily be acquired and bullets cast. Due to the wall thickness of our brass tube (thicker than that of a factory manufactured case) we cannot seat 'off the shelf' bullets without first re-sizing them to fit our handmade cases. For this purpose we must make a very simple sizing die to re-size our bullets to the correct diameter.



Drilling the die holes.

The homemade re-sizing die is nothing more than a modified section of box section tubing. I am using 30 x 30mm tube with a wall thickness of 2.5mm. The length of the tube is also 30mm, just to keep things simple. For accuracy of drilling a drill press must be used to make the die. The first step is to drill a 2mm or 3mm pilot hole through the centre of the tube section. The hole must pass through both walls. Next, the hole is enlarged to 5mm or 6mm, and then the final 8.9mm hole is drilled (carefully and slowly) again making sure the drill passes through both walls. The holes can be made by simply holding the tube section on the drill table with your hand and drilling the holes. It is not necessary to clamp the tube or hold it in a vice.



Drill the tube.



Solder the nut.

We now have the main body of a simple sizing die through which to pass our bullets.

The next step is to simply solder an 8mm (M8) nut to the inside wall of the die in alignment with one of the holes, as shown in the above photo.

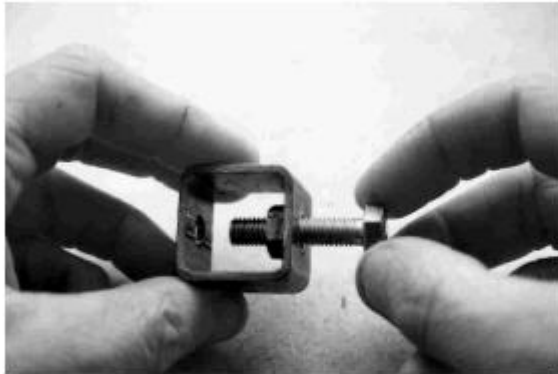

Screw in the die bolt.

An 8mm bolt, 2" in length, is now screwed into the die. It should screw freely in and out. The bolt allows us to press the bullet through the opposite hole.

The finished die is shown below.



The finished die tool.

We must re-size our bullets to a diameter of 8.9mm in order for them to fit into our .38 cases. This diameter of bullet is obviously less than any factory made or home cast bullet, but still of sufficient diameter to engage the riffling of any .38 calibre handgun. Just as with our cases, we must compromise to get the job done.

In the photo below I am sizing 9mm jacketed bullets because they are as near to the diameter we require as bought (9mm - .356") and less sizing will be required as a result. You can of course re-size any .38 *lead* bullet (.358" - 9.09mm) and from a re-sizing standpoint any lead bullet is easier to size than the jacketed variety. I am using jacketed bullets simply because that is what was available at the time of writing but it does illustrate that even the hard case of the jacketed bullet can be sized using this simple device.

To size the bullet, place the bullet in the die as shown in the photo below and, using a spanner, slowly tighten the bolt.



Press the
bullet through
the die.

Screwing the bolt in will drive the bullet through the opposite hole sizing the bullet to a diameter of 8.9mm. I would suggest sizing perhaps fifty or so bullets in one session so as to have a ready supply.



BULLET SEATING DIE



The bullet seating die.

Now that we have our supply of resized bullets we can begin the reloading process and start seating bullets into our cases. But before this can be done a simple 'bullet seating die' must be made.

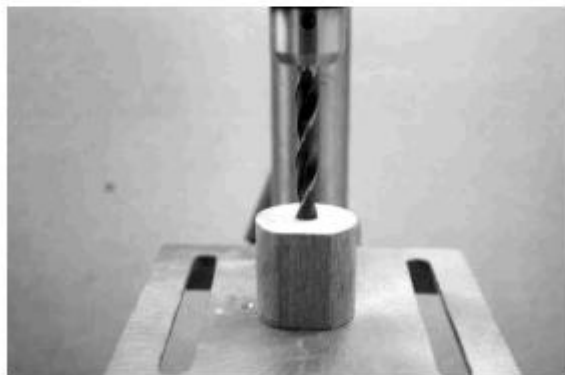

Drilling the bores.

The purpose of the die is to ensure bullets are driven into the cartridge case accurately. The die is made from a simple section of hardwood. I am using a section of banister rail, and a 50mm diameter washer with a

10mm diameter hole. We also require an 8mm diameter bolt, 50mm (2") long and two nuts to fit the bolt. Any section of hardwood will do and ideally it should be around 1" in diameter. The rail section I use was actually 45mm in diameter but it was easy to obtain so I used it. Whatever wood section is used, it should measure about 45mm in length.

As shown in the above photo, a hole is drilled through the centre of the die. A drill press must be used for this purpose. We must drill two separate diameter bores through the die, one to accept the case and the other the bullet. *It is of vital importance that both ends of the die are perfectly square before attempting to drill any of the bore holes.*

The first hole to be made is the 'Case Bore' to accept the cartridge case. This is drilled to a diameter of 9.9 or 10mm (25/64"). The second hole to be made is the 'Bullet Bore' to a diameter of 9mm (23/64"). *The bullet bore must be drilled first.*

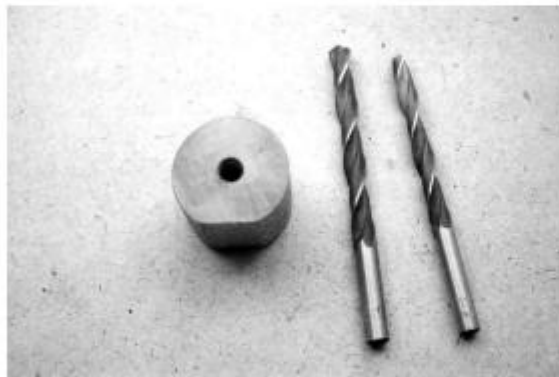

Two bore diameters are drilled.

The two bores must be drilled slowly. At regular intervals during drilling the drill handle should be raised and any wood shavings released from the bit. This will ensure the bores are drilled as cleanly as possible.

To drill the bullet bore hole, hold the die on the drill table and slowly drill all the way through the centre of the die, regularly releasing drill pressure to allow shavings to be removed. *Do not* move or rotate the die once the first hole had been made. Lower the drill table and remove the drill. Now place the 9.9mm 'Case Bore' drill in the chuck and carefully raise the drill table back into alignment with the new drill bit.

Now carefully drill the second bore to a depth of 30mm. This is the bore that will accept the cartridge case in due course. The bores of the die should now be inspected to ensure they are clean and true. It is a good idea to insert each of the two drill bits just used back into each bore and rotate them several times by hand to remove any slight imperfections or wood shavings. The top washer can now be screwed to the bullet bore end of the die. A washer of similar diameter to the die should be used, in my case 50mm. Drill a couple of holes either side of the washers 10mm hole and countersink each hole. Now use a couple of short screws to attach the washer to the die. Now attach the two nuts to the bolt and insert the bolt into the die. The die is now ready for use.



The finished seating die.

The two nuts act as an adjustment method to alter as necessary the depth to which a bullet is seated.



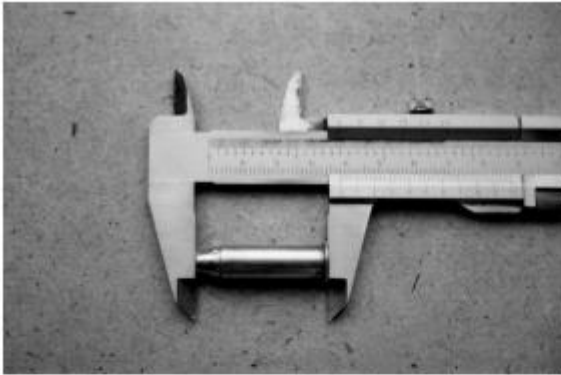

Checking the cartridge length.

Adjust the bolt nuts gradually during the seating of the first bullet until the cartridge measures 37.5mm, as shown above. Once the nuts are 'set' at this position all future cartridges can be loaded without touching the two lock nuts again.



The loaded improvised cartridge compares favourably with its factory made counterpart. Once the necessary materials are acquired and the simple loading tools made, reloading these .38 Special cartridges is nearly as easy as loading using conventional reloading methods.

**Bullet seating die dimensions
for the .38 special.**

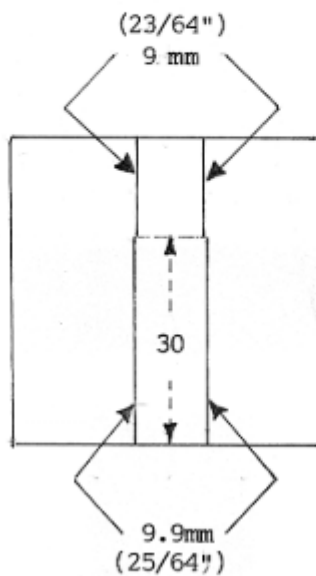

As an alternative to using the brass curtain ring for the case rim we can use a simple 10mm diameter circlip, as shown below.



Attach the clip.

The circlip is attached to the case using a pair of circlip pliers. It can be fitted by hand but it is easier with the correct tool. The clip is attached to the very end of the case.



Apply the solder.

Apply solder paint to the clip circumference and solder the clip in place. It is possible to shoot these cartridges in a revolver without actually

soldering the clip providing the clip is tight enough but tension of the clips do tend to vary so it will be down to trial and error as to whether you use solder or not. I would strongly advise doing so to make the clip as secure as possible.



Clip attached.

The two clip plier holes will need to be filed or ground away once the rim is fitted to allow the round to be loaded into a revolver cylinder. If the plier holes are not removed the cartridge will still chamber but only with the clips open side facing outwards away from the cylinders axis. It will be obvious to those readers with a knowledge of revolver and cartridge design history that the circlip is reminiscent of the half moon clips used for loading the .45acp auto pistol cartridges in the revolvers. Our improvised version works just as well !



I AM THE CAPTAIN OF MY FATE
I AM THE MASTER OF MY SOUL

Cartridge Schematics

ROLL CRIMP

CASE WALLS ARE "ROLLED"
INTO THE CANNELURE GROOVE
OF THE BULLET.

CASE NECK TENSION STILL
HOLDS THE BULLET IN THE CASE,
BUT THE ROLL CRIMP HELPS
PREVENT MOVEMENT.

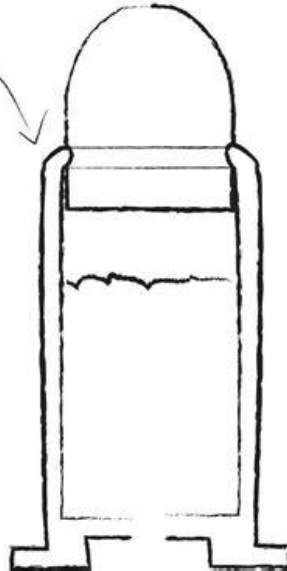

Not every bullet has a cannelure groove or is roll crimped. Below are 3 dies from Dillon designed to progressively taper a case. Note one creates the neck, one crimps and one tapers. Add the primer last.



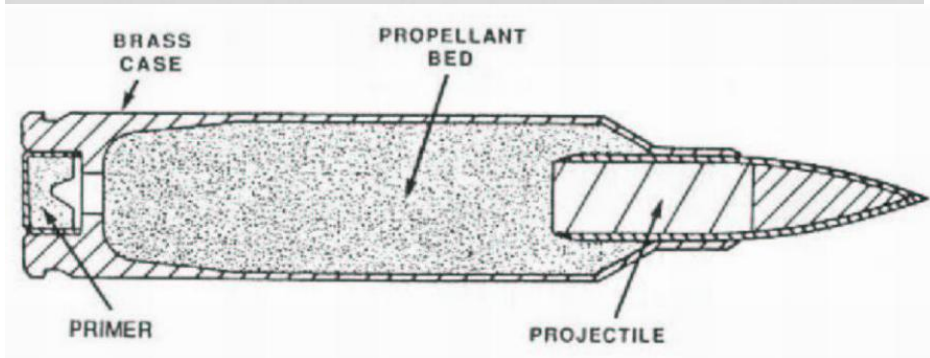
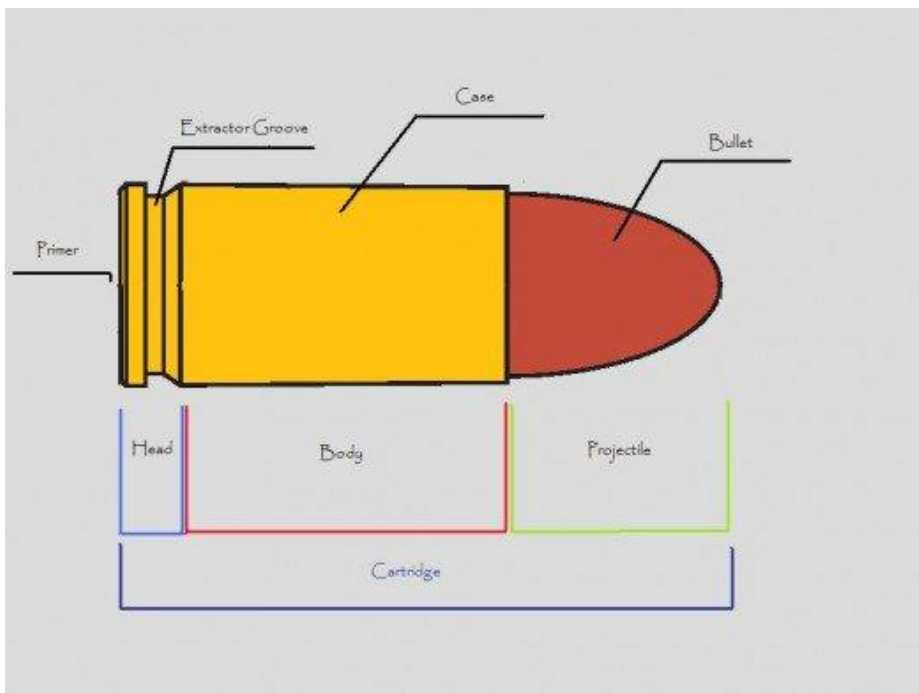

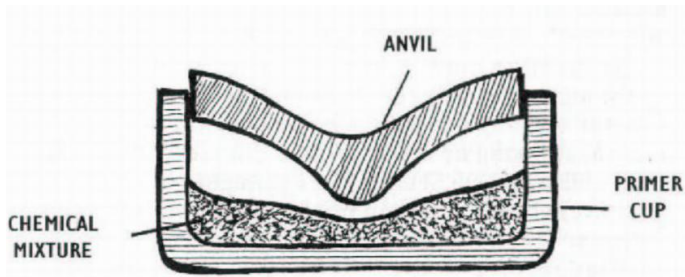

Cross section of Boxer primer.

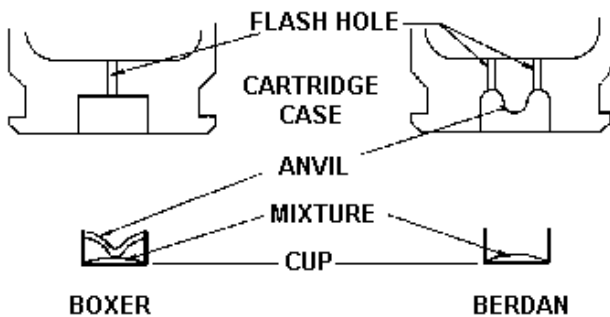
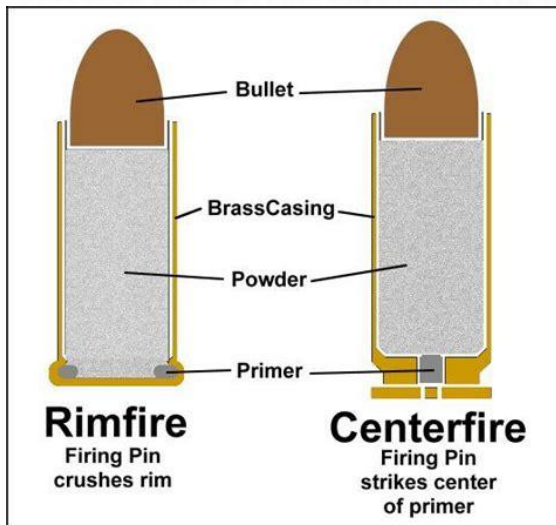



Remember: the anvil is to crush the explosive between the cup and the anvil in order to ignite it. Make sure it is a shape which allows it to compress the explosive and push against the case. You do not want a loose anvil.

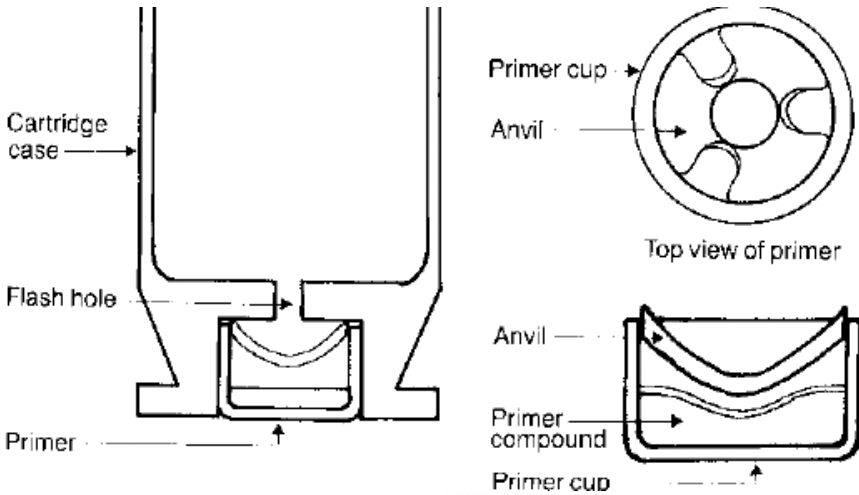

Boxer



Berdan

9mm Automatic

(XX.XX) = MILLIMETERS

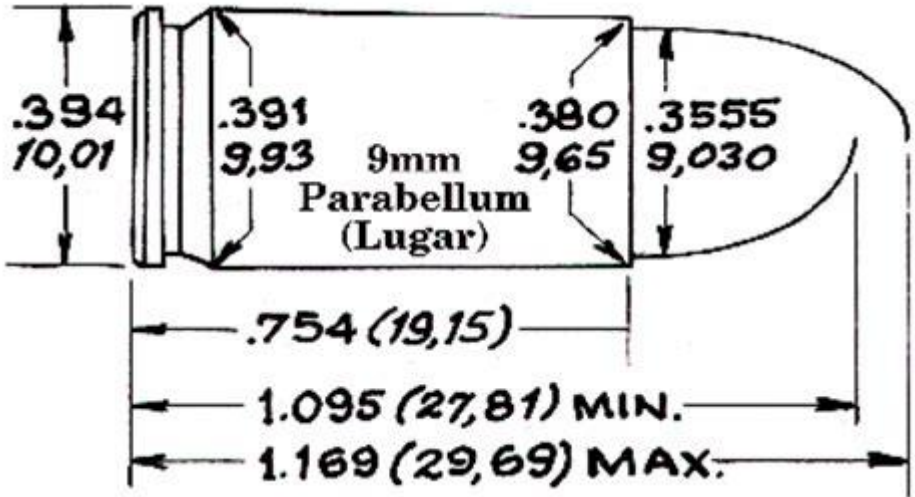
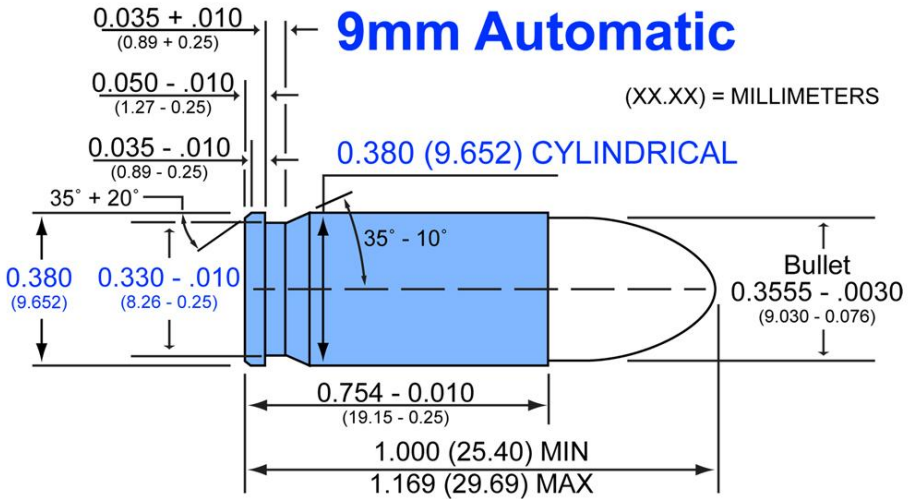

.38 SPECIAL

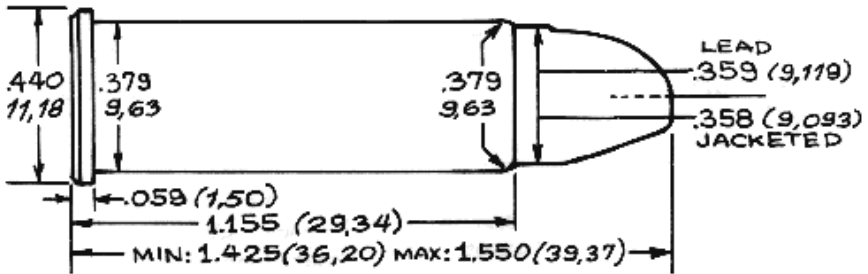

SECTION I - CHARACTERISTICS
 CENTERFIRE PISTOL & REVOLVER
 SAAMI VOLUNTARY PERFORMANCE STANDARDS

CARTRIDGE & CHAMBER
 38 SPECIAL
 38 SPECIAL +P

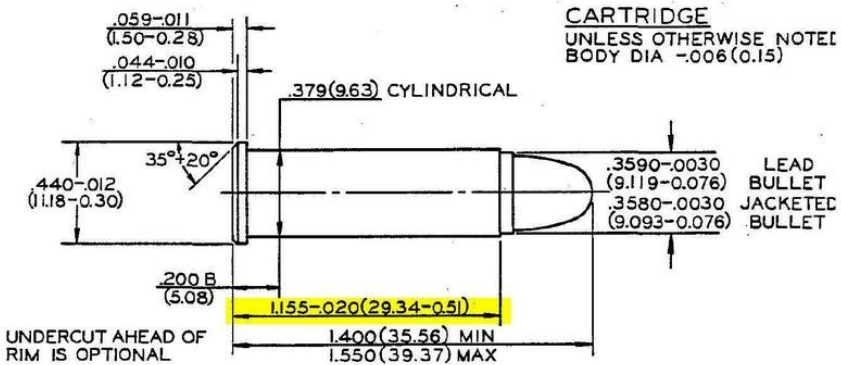

5.56mm NATO

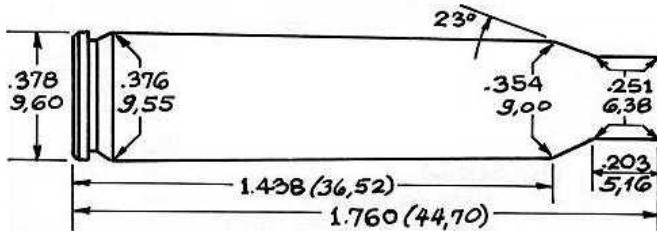

The NATO 7.62x51 / Winchester .380 Round

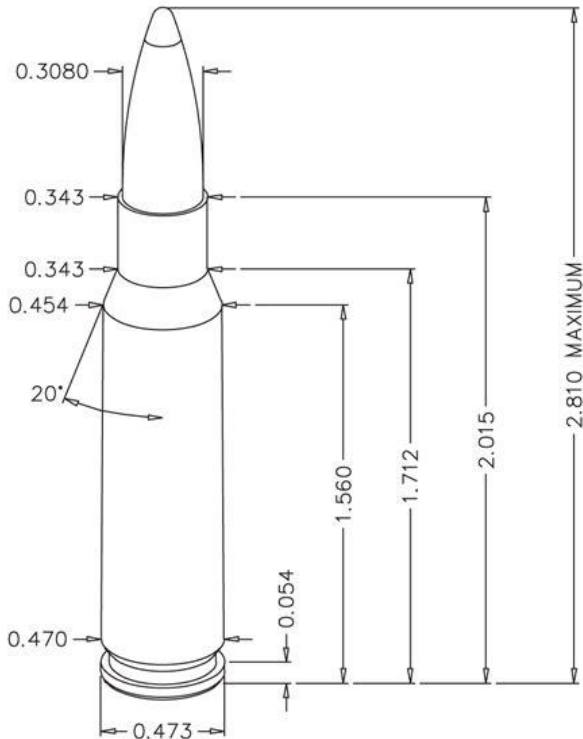

.22 K-Hornet (40°)

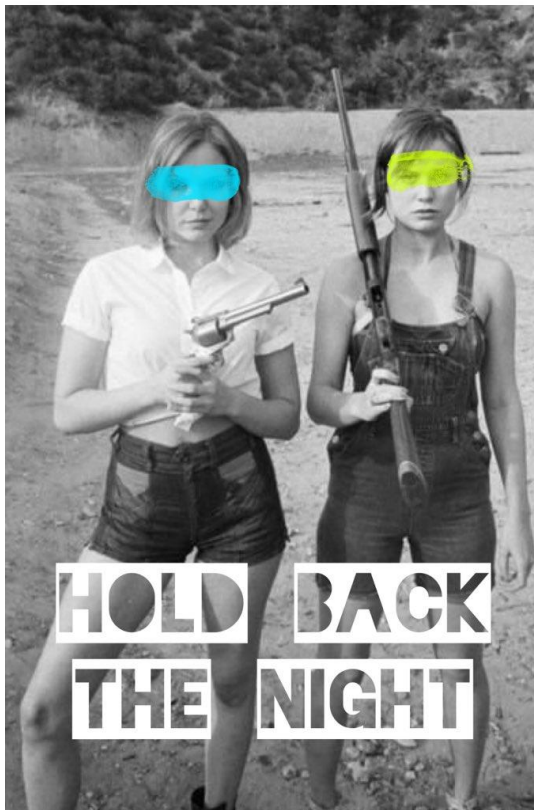
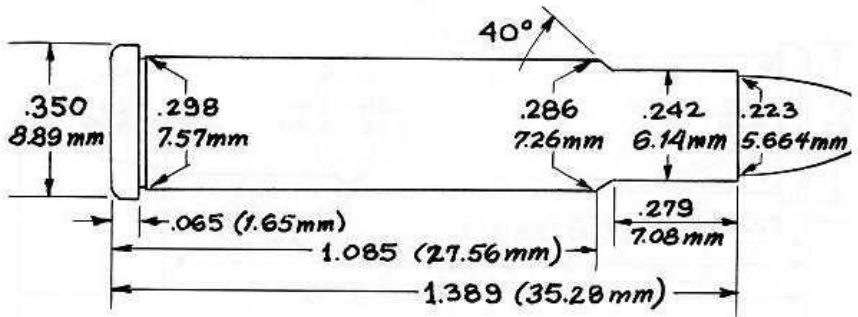

SPECIAL AMMUNITION FOR HANDGUNS

If an individual wished to produce explosive ammunition for his/her handgun, he/she could do it, provided that the person had an impact-sensitive explosive and a few simple tools. One would first purchase all lead bullets, and then make or acquire an impact-detonating explosive. By drilling a hole in a lead bullet with a drill, a space could be created for the placement of an explosive. After filling the hole with an explosive, it would be sealed in the bullet with a drop of hot wax from a candle.

This hollow space design also works for putting poison in bullets.

SPECIAL AMMUNITION FOR SHOTGUNS

Because of their large bore and high power, it is possible to create some extremely powerful special ammunition for use in shotguns. If a shotgun shell is opened at the top, and the shot removed, the shell can be re-closed. Then, if one can find a very smooth, lightweight wooden dowel that is close to the bore width of the shotgun, a person can make several types of shotgun-launched weapons.

Insert the dowel in the barrel of the shotgun with the shell without the shot in the firing chamber. Mark the dowel about six inches away from the end of the barrel, and remove it from the barrel.

Next, decide what type of explosive or incendiary device is to be used. This device can be a chemical fire bottle (See Black Book for instructions), a pipe bomb, or a thermite bomb (See Black Book for instructions). After the device is made, it must be securely attached to the dowel. When this is done, place the dowel back in the shotgun. The bomb or incendiary device should be on the end of the dowel.

Make sure that the device has a long enough fuse, light the fuse, and fire the shotgun. If the projectile is not too heavy, ranges of up to 300 ft are possible.

XVI. Explosives



Basic Safety Rules

1) Don't smoke! (don't laugh- an errant cigarette wiped out the Weathermen). Avoid open flames, especially when working with flammable liquids or powdered metals.

2) Grind all ingredients separately. It is alarming how friction sensitive some supposedly safe compositions really are. Grinding causes heat and possibly sparks, both of which can initiate an explosion.

3) Start with very small quantities. Even small quantities of high explosives can be very dangerous. Once you have some idea of the power of the explosive, you can progress to larger amounts. Store high explosives separately from low explosives, and sensitive devices, such as blasting caps, should be stored well away from all flammable or explosive material.

4) Allow for a 20% margin of error. Never let your safety depend on the expected results. Just because the average burning rate of a fuse is 30 secs/foot, don't depend on the 6 inches sticking out of your pipe bomb to take exactly 15 seconds.

5) Never underestimate the range of your shrapnel. The cap from a pipe bomb can often travel a block or more at high velocities before coming to rest- If you have to stay nearby, remember that if you can see it, it can kill you.

6) At the least, take the author's precautions. When mixing sensitive compounds (such as flash powder) avoid all sources of static electricity. Work in an area with moderate humidity, good ventilation, and watch out for sources of sparks and flame, which can ignite particles suspended in the air. Always follow the directions given and never take shortcuts.

7) Buy quality safety equipment, and use it at all times. Always wear a face shield, or at the minimum, shatterproof lab glasses. It's usually a good idea to wear gloves when handling corrosive chemicals, and a lab apron can help prevent life-threatening burns.

HOW TO MIX INGREDIENTS

The best way to mix two dry chemicals to form an explosive is to do as the small-scale fireworks manufacturer's do:

Ingredients: 1 large sheet of smooth paper (for example a page from a newspaper that does not use staples), The dry chemicals needed for the desired compound.

1) Measure out the appropriate amounts of the two chemicals, and pour them in two small heaps near opposite corners of the sheet.

2) Pick up the sheet by the two corners near the powders, allowing the powders to roll towards the middle of the sheet.

3) By raising one corner and then the other, roll the powders back and forth in the middle of the open sheet, taking care not to let the mixture spill from either of the loose ends.

4) Pour the powder off from the middle of the sheet, and use immediately. If it

must be stored use airtight containers and store away from people, houses, and valuable items.

Primary and Secondary Explosives

This appendix ranks the various primary and secondary explosives outlined in *Black Book*, volumes 1, 2, and 3 and in the *Black Book Companion* in order of suitability for use in compound detonators.

PRIMARY EXPLOSIVES

DDNP	HMTD
Lead azide	MEKAP
Mercury fulminate	Acetone peroxide
Double salts	

SECONDARY EXPLOSIVES

RDX	Double-base powder
PETN	Single-base powder
TNT	(nitrocellulose)
Picric acid	Ammonium picrate
Starch nitrate	DDNP

For more information consult the *Black Book* or *Black Book companion* from Paladin Press.

HMTD (Hexamethylenetriperoxidodiamine)

DETONATION VELOCITY 4511 M/sec. @ 0.88 G/cc 5100 M/sec. @ 1.10 G/cc

FRICION SENSITIVITY Very Sensitive!!!

BEHAVIOR TO FLAME Small quantities flash like guncotton Large accumulations will detonate.

HMTD is a high performance initiating explosive. It is one of the better initiating explosives but has some definite drawbacks. HMTD is not stable at even slightly elevated temperatures. Room temperature will even cause a decrease in performance with storage time. As one would imagine, due to the extreme excess of oxygen, the corrosion of metals in contact with the peroxide is a problem. The metals that will cause problems are aluminum, zinc, antimony, brass, copper, lead and iron. These metals in contact with the HMTD even when dry, will cause corrosion. With water present, in the HMTD, the corrosion would more quickly disable an improvised blasting cap that could be made with this material. Spraying the inside of your copper tubing with urethane plastic would most likely reduce greatly, if not completely stop, this corrosion problem. To manufacture HMTD, use one of the processes below.

Process #1

Obtain 6% hair bleaching peroxide which is available from any beauty salon or beauty supply store. This is a 20 volume hydrogen peroxide. Place 9 teaspoons of this. 6% peroxide in a one pint canning jar or 500 ml beaker. In three portions dissolve by stirring 2-1/2 teaspoons of powdered hexamine (Crushed U.S. Army ration heating tablets, See "Kitchen Improvised Plastic Explosives" chapter 2, "Urintropine" etc.). This is stirred until all the hexamine dissolves. The solution should then be chilled in a ice water bath for 1/2 hour. To this chilled solution add, in four portions, 4-1/2 teaspoons of powdered citric acid. Citric acid is readily available and should be found with canning supplies or in a pharmacy. With each addition the solution should be stirred until the citric acid dissolves in the liquid before another addition is made. When all the additions have been made continue stirring the liquid. The beaker or jar containing the solution should remain in the ice bath. The solution will become cloudy. With the completion of the 1/2 hour stirring the liquid is placed in a refrigerator. This will speed the process. If a refrigerator is not available let the solution stand for 24 hours. Filter the solution through a paper towel or coffee filter. The white substance is the explosive.

CAUTION: HMTD is sensitive to shock, impact, friction, heat and open flame. Extreme care should be exercised. HMTD will detonate from any of these stimuli even when soaked with water.

These white crystals are washed with 45 ml of distilled water. Tap water can be used if necessary, but will yield a compound of lesser purity. They are then washed with 75 ml methanol alcohol. These crystals are allowed to dry in a cool dry place. If

a 30% technical grade ("Superoxol") of hydrogen peroxide is available it should be used instead of the 6%. If 30% is used the proportions are as follows to use in the same process as above are:

HYDROGEN PEROXIDE. "Superoxol" (30% d. 1.11 G/cc)- 185 G HEXAMINE
(Crushed ration heating tablets) 56 G CITRIC ACID (tech. grade or food
grade) 84 G

These are used in the procedure given above. Simply "plug in" the amount immediately above for the spoon wise proportions given in the 6% hydrogen peroxide process and the washing would be done with 150 ml cold water. Of course in the procedure if 35% or 40% is the only type hydrogen peroxide available, then simply calculate the actual weight of hydrogen peroxide. We know that 185 G. of peroxide are used above. This is 30% hydrogen peroxide. $185 \text{ G.} \times 0.30 = 55.5 \text{ G.}$ We know that we need 55.5 G. hydrogen peroxide. Suppose we have some 40% peroxide. We take our 55.5 and divide by .40 thus $55.5 / 0.40 = 138.75$. Simply use 139.0 G. of this 40% hydrogen peroxide in the procedure above. The yield of this process with 30% hydrogen peroxide is much greater than is the use of 6% hydrogen peroxide. But with the 6% being the easier of the two to obtain it still would hold possibilities

PROCESS #2

This second process is one of very easy acquisition of the main ingredients. Yield is not as high as the procedure above with either strength peroxide. This process makes use of the easy formation of hexamine and the parallel formation of a slightly acid solution. This acid is liberated from the ammonium sulfate salt. It is, of course, sulfuric acid. This acid performs the function of the citric acid in the procedure above. This is after the free ammonia and the formaldehyde form hexamine. Yield will be relatively low with this procedure but the materials are readily available and cheap. Since this procedure takes place at an elevated temperature there will be some loss of product to this subsequent heat and the decomposition that will accompany it. This process will work and could be used if necessary.

Five hundred grams of 3% hydrogen peroxide are placed in a quart jar or 1000 ml beaker. Three percent hydrogen peroxide is available as an antiseptic solution in grocery stores, etc... To this is added fifty grams ammonium sulfate. Ammonium sulfate is available as common fertilizer. This is stirred until dissolved. This liquid should be heated in a water bath to 55 degrees C. (131 degrees F.). Immediately when the temperature reaches this temperature add 5.3 grams of 37% formaldehyde solution. Stir this solution well and take off water bath. Let this liquid cool to room temperature and set for 24 hours. A white product will be seen in the liquid at this time.

CAUTION: This white product is dangerous and sensitive to FRICTION, SHOCK, HEAT OR FLAME. Handle with great care !! Even wet H.M.T.D. is dangerous and

will detonate with ease.

This is filtered out and washed with one washing of 50 ml distilled water and then with 75 ml of 100% methanol. The methanol will speed the drying process. This white fluffy powder will be H.M.T.D. This powder will be sensitive to friction and small quantities should be handled.

Lead Azide

Preparation of Hydrazinium sulfate.

One-hundred-forty-one ml of Chlorox bleach (5.25 percent NaOCl) was added to 200 ml of 20 percent ammonium hydroxide and 5 ml of 1 percent limewater $\text{Ca}(\text{OH})_2$ in one liter Erlenmeyer flask. The mixture was rapidly heated to boiling and maintained until the volume was reduced to about half, which required about one-half hour. The solution was rapidly cooled and dilute sulfuric acid was added until a pH of 7-8 has attained and the precipitate that formed was separated by filtration. The cold filtrate was strongly acidified with 40 percent sulfuric acid. The white precipitate was filtered, washed with methanol and air dried. Melting point 254 degrees C (lit. 254 degrees C).

Preparation of Isopropyl Nitrite

A mixture of 45 ml concentrated sulfuric acid, 30 ml water and 110 ml isopropyl alcohol, previously cooled to 0 centigrades, was added to an ice cold solution of 114 grams of sodium nitrite in 450 ml of H_2O . Slow addition required about two hours in order to maintain a temperature around 0 centigrades. The upper oily layer was separated and washed three times with 30 ml portions of 5 gram 100 ml sodium bicarbonate solution and 22 grams NaCl 100 ml solution respectively.

Preparation of Sodium Azide

Five grams of caustic soda (NaOH) was dissolved in 50 ml of ethyl alcohol (3A), and the clear portion was decanted in a 100 ml distilling flask containing 6 ml of hydrazine hydrate. After adding one ml of butyl nitrite (or isopropyl nitrite) the mixture was heated on a steam bath to initiate the reaction. Twelve ml more of the nitrite was slowly added in such a manner that the mixture refluxed slowly. Addition required about one hour and the mixture was heated an additional fifteen minutes. The reaction flask was cooled and the solid product collected on a filter. The product was washed with alcohol and air dried. Recrystallization from water yielded white crystalline material.

Preparation of Lead Azide

The following solutions were prepared:

Solution A: 0.20 g of sodium azide 0.006 g of sodium hydroxide 7 ml water

Solution B: 0.96 g $\text{Pb}(\text{NO}_3)_2$ 0.04 g Dextrin 9 ml water

Solution B was brought to a pH of 5 by adding dilute NaOH.

Solution B was brought to 60 centigrades and solution A was slowly added with stirring. The mixture was allowed to stir till ambient temperature was attained and the solid azide collected on a filter. After washing with water and air drying the product weighed 0.4 grams. This product was found capable of initiating RDX when incorporated in a No. 6 blasting cap.

DDNP (Diazodinitrophenol)

DETONATION VELOCITY 4400 M/sec. @ 0.9 G/cc

6600 M/sec. @ 1.5 G/cc

6900 M/sec. @ 1.6 G/cc

FRICITION SENSITIVITY - Less sensitive than mercury fulminate and the same as lead azide.

BEHAVIOR TO FLAME - Small quantities flash like guncotton. Large 6 grams and larger would likely detonate.

DDNP is one of the highest in performance of nearly all the homemade primary explosive. It is stable and compatible with other explosives, but, lead azide. This is a good choice for manufacture as the precursor to this DDNP primary explosive is picric acid. Picric acid is more powerful than T.N.T. with a detonation rate of 7200 M/sec. it becomes the base charge for your homemade caps. It is prepared by a diazotization reaction on picramic acid. This is produced from picric acid, sodium hydroxide (lye) and sulfur. See picric acid for it's manufacture instructions.

MANUFACTURE:

In a pint glass jar place 90 ml warm water and 1.5 grams of lye (sodium hydroxide). Mix these with a "teflon" stirrer until all the lye had dissolved. Dissolve 9 grams of picric acid crystals in the lye water solution by stirring. Label this jar solution #1. In a 500 ml beaker 3 ml of water is placed. Dissolve 7.5 grams of sulfur and 7.5 grams of lye (sodium hydroxide) by stirring the solution. Boil this solution over a heat source. When the solution turns dark red remove and allow the liquid to cool. Label this solution #2. Add this cooled solution #2 in three portions, to solution #1. Stir with a teflon rod while the liquid is being added. Again allow the solution mixture cool. Filter this mixture through filter papers (coffee filter, paper towels). Small red particles will gather on the paper. Discard the liquid. Dissolve these red particle in 180 ml of boiling water. Remove and filter this hot liquid through a filter paper (coffee filter, paper towels). Discard the particles left on the paper and label the liquid left #3. To Solution t#3 with an eyedropper slowly add sulfuric acid (Janitor supply, boiled battery acid) to the filtered solution until it turns orange brown. Add an additional 7.5 grams of acid to the liquid. In a separate pint jar, dissolve 5.4 grams of potassium or sodium nitrite in 240 ml of water. Label this solution #4. In one portion solution #4 is added with stirring to

solution #3. Allow the solution to stand for 10 minutes. The mixture will turn light brown.

CAUTION: At this point the brown color is the DDNP that has formed. Keep away from flame, avoid friction and keep from shock.

Filter the light brown solution through a filter paper (paper towel, coffee filter). Wash the particles left on the paper with 60 ml of water. Allow to completely dry for 24 hours. Drying time can be reduced to 2 hours if crystals are placed in a shallow pyrex dish and this placed in a hot (not boiling) water bath.

CAUTION: DDNP is sensitive to shock, friction and flame. Expose to any of these will very likely detonate the compound prematurely.

This powder should be stored in small quantities in stoppered glass containers. More safety in storage leave 25% water in the powder and dry immediately prior to use.

ACETONE PEROXIDE (Acetonetriperoxide)

DETONATION VELOCITY 3750 M/sec @ 0.92 G/cc

5300 M/sec @ 1.18 G/cc

FRICION SENSITIVITY - Very sensitive. One of the more sensitive in this book.

BEHAVIOR TO FLAME - Burns violently and sometimes detonates even in small quantities.

Acetone peroxide is a powerful primary explosive. It, as with other explosive peroxides, seems to be very volatile. In standing 10 days at room temperature, 50% of the sample will completely volatilize. It is a powerful, brilliant explosive. It's vaporizable nature makes it a explosive that would have to be used immediately after manufacture. However, this explosive is compatible with metals and will not cause their corrosion and the subsequent dangers involved. It is also compatible with picric acid, R.D.X., T.N.T., P.E.T.N., Tetryl, potassium chlorate and antimony sulfide.

It is highly friction sensitive and extreme care should be taken to avoid this. Acetone peroxide is one of the most sensitive explosive known to man. Great care would be needed to handle this explosive carefully. It is a powerful primary base charge in the cap. Also mixtures of R.D.X. and Picric acid with acetone peroxide are reported to be used between primary explosive and the base charge.

CAUTION: Acetone peroxide one of the most sensitive explosive known to man. this composition is dangerous and would need to be handled by someone with a lot of common sense. Mixtures such as picric acid/acetone peroxide (40/60) or similar mixtures with R.D.X. and P.E.T.N. will give explosives greatly increased resistance to impact without losing much initiation performance.

Great care would be needed to ensure the safety of the manufacturer due to the high sensitivity of the acetone peroxide. These dried crystals would be ready to load into detonators for immediate use as the storage stability is not very good.

MANUFACTURE:

Acetone peroxide is formed when hydrogen peroxide 30% acts on acetone. The introduction of dilute sulfuric acid causes the reaction to go into completion. Procedure is as follows. 50 ml acetone is placed in a one pint jar or 500 ml beaker. To this is added 30 ml hydrogen peroxide (30%). This liquid is placed in an ice water bath and cooled to 5 degrees centigrade. To this cooled mixture is added 3 ml of sulfuric acid (20%). This addition is done at 5 degrees centigrade and done in a drop wise fashion. When the temperature begins to rise (10 degrees C.), slow the addition until the temperature falls again. With the completion of the addition stir the mixture. A flocculent precipitate will form. This is filtered out after the mixture stands for one hour. Wash the white product three times with water (distilled preferably). Let the material filtered out of the reaction liquids and washed and dry this solid. By spreading out the acetone peroxide this drying process can be speeded up. These dry crystals are now ready for loading into the caps as a primary explosives.

DOUBLE SALTS

DETONATION VELOCITY 3600 M/sec. @ 3.96 G/cc

FRICION SENSITIVITY - This primary explosive is on the same order of sensitivity as is lead azide.

BEHAVIOR TO FLAME - Burns violently and sometimes detonates even in small quantities.

These double salts are a basic acetylide group primary explosive. This explosive has good sensitivity, powder and performance. It is readily made from silver (coin), nitric acid and calcium carbide/ water or acetylene. This is an easy compound to make. What I found interesting is the fact that this primary is not photo active. Most silver salts are light sensitive. This would be a good choice due to the wide availability to the main ingredients. DDNP, HMTD and mercury fulminate, are better primary explosives but this one has many possibilities. With this primary explosive suitable caps could be made and would be very usable and storage stable as some others in this publication could not.

MANUFACTURE:

Dilute 10.1 ml of nitric acid (red fuming) with 6.75 ml of water. If reagent or technical grade acid is available (70% strength) this will not need any water mixed with it to reduce the strength. Simply use 17.5 ml of this 70% nitric acid. Place a silver dime or equivalent amount of silver metal in the acid. It will dissolve leaving a green solution.

CAUTION: Avoid the brown gas (nitrogen dioxide) produced when dissolving the silver metal in the acid. This gas is a deadly poison and the immediate exposure to the gas and its subsequent damage will not show up for hours or even days! This should be done with good ventilation!

It may be necessary to heat the liquid to get the coin or metal to completely dissolve. Pour this green solution into a tall slender glass jar such as an olive jar. Place this jar with the green solution in it in a hot water bath and heat. Crystals will form. The heating is continued until these crystals dissolve again. In another flask or even a "Coke" bottle, place ten teaspoons of calcium carbide into this flask with a cork with a hose passing through a hole in the cork. Place the other end of the hose in the tall jar with the solution in it. Remove the stopper from the flask or bottle and add one teaspoon of water.

CAUTION: Acetylene gas is highly flammable and an explosion hazard. Keep away from heat and flame as much as possible.

The gas should begin generating. Add one more teaspoon and place the stopper back into the container. The acetylene gas generated by the calcium carbide and water should be going through the hose and bubbling through the solution in the tall glass. Bubble this gas through the solution for 5-8 minutes. Brown vapor will be given off by the liquid as it absorbs acetylene and white flakes will begin to be formed in the silver solution. Remove the solution from the heat source and allow it to cool. Filter the liquid through a filter paper (paper towel, coffee filter) into a glass container. Green crystals will be caught on the filter paper. These green crystals would then be washed with 45 ml alcohol. The crystals will change from green to white in color and the methanol wash will turn green. Place these white crystals on a paper towel and allow to air dry.

CAUTION: Handle this dry explosive with great care. Do not scrape or handle roughly. Keep away from flame or spark source or heat and store in a cool dry place.

These salts will perform well and are easy to make. Their stability is good, which is very important. A good choice of primary explosives.

TACC (Tetraminecopper (II) Chlorate)

DETONATION VELOCITY - Not given

FRICTION SENSITIVITY - This primary explosive is as sensitive as is lead azide

BEHAVIOR TO FLAME - Deflagrates with a green flame. Requires confinement to detonate.

Tetramine copper chlorate is a very interesting primary explosive. While it has these good properties it is also easily made. Its drawbacks are the tendency to "dead press" or become so packed that it will not detonate the base charge in the cap and water contamination problems. For this primary explosive to detonate it

must be loose in the detonator shell. It would be best used in caps where the base charge is pressed in first. Rifle shell improvised blasting caps would not work well with this explosive due to this property. In this reaction the sodium chlorate and the copper sulfate are heated together with methanol. This reaction produced copper chlorate. This copper chlorate dissolved in methanol. It then has ammonia gas bubbled through the solution. The tetramine group is added in this step. So the main actors in this chemical play are copper sulfate other wise known as "blue vitriol". Copper sulfate is available from feed stores or electroplating chemical supplier. Sodium chlorate is also a chemical required and would be available from matches, dyes, textiles manufacture and as a weed killer. "Kitchen Improved Plastic Explosives" has a section on chlorate manufacture in chapters four five and six. Ammonia is the last building block. This can be generated in one of two ways which will be explained in the manufacture section. The methanol used is just a reaction liquid and a carrier, as it does not actually enter into the reaction. One problem with this process is the contamination of the methanol with water. This allows the sodium sulfate to become soluble in the first reaction and will remove the ability to separate the products of the reaction. The process is longer than others but is simple and produced a good purity, stable product. This primary explosive should be kept dry, as it could begin to decompose in the presence of moisture.

MANUFACTURE:

Measure 15 grams of sodium chlorate into a large mouth pint bottle. Sodium chlorate is the oxidizer in matches. It is also available as a weed killer. Add 360 ml of methanol or ethanol to the sodium chlorate in the pint jar. To this add 24 grams of copper sulfate. Place this liquid in a hot water bath. Heat at the boiling point for 30 minutes with occasionally stirring the liquid during the reaction.

CAUTION: Remember methanol is very flammable and great care should be taken to ensure the lack of open flame in it s proximity. Avoid breathing the vapors of methanol.

Keep the volume constant by continually adding alcohol to replace what is being boiled away. After 30 minutes remove the jar from the water bath. The color of the solution should change from blue to light green. Filter the solution into a jar through a paper towel or drip coffee filter. The filtrate (liquid) should be caught in a jar similar to the one used in the first step. Label this liquid #1. In a narrow necked gallon jar or flask and a stopper (one hole) place 1500 ml clear ammonia water in the solution. This is available from the grocery store in a clear non soapy form. In the mouth of this is placed a stopper with one hole and a plastic or rubber hose. This is placed into a hot water bath. Ammonia will begin to generate out of the gallon jug. A better ammonia generator could be made by filling a long necked bottle or flask with 250 grams lye (sodium hydroxide). 500 grams of dry ammonium nitrate fertilizer or ammonium sulfate fertilizer is added. Addition of small quantities of water and closing with a stopper hose set up could generate

greater quantities of ammonia and it would be drier ammonia due to the nature of its generation. Generation would be maintained by the addition of more water. But with either method the hose should be placed in the liquid in the liquid #1. The ammonia gas should be bubbled through the liquid. It will begin to absorb ammonia turn light blue. Continue bubbling for 10 minutes.

CAUTION: The ammonia gas generated will kill or cause grave damage if exposure is severe. Use with good ventilation.

The solution will turn dark blue. Bubble the ammonia gas through solution #1 for ten more minutes and remove the hose from the solution. Reduce the volume of the liquid by pouring into a shallow pyrex dish. Set this dish under a fan and allow 1/2 the alcohol to evaporate. Filter (paper towel or drip coffee filters) the crystals that remain in the liquid and wash them with 50 ml very cold methanol. Set these aside to dry for 16-24 hours.

CAUTION: Explosive is shock and flame sensitive and great care should be exercised during handling.

MERCURY FULMINATE

DETONATION VELOCITY - 3500 M/sec. @2.0 G/cc.

4250 M/sec. @3.0 G/cc.

5000 M/sec. @4.0 G/cc.

FRICITION SENSITIVITY - Sensitive to friction and shocks

BEHAVIOR TO FLAME - Deflagrates when one crystal is ignited. Layers several crystals deep detonate violently.

Mercury fulminate had it's industrial beginnings in 1867. Alfred Nobel took out a British patent on the blasting cap, its use and makeup. His first blasting caps were simple ones very similar in many ways to the one in this book. Mercury fulminate was chosen out of a field of explosive fulminating compositions. This was mainly due to the stability that could be obtained and the ability to lend it's self to commercial manufacture at that time. Of course, the primary explosives used today are much superior to mercury fulminate. Mercury fulminate is not good for storage at elevated temperatures over 6-12 months. Five years in the magazine could disable caps. It is a good choice for clandestine manufacture. It would also be a very good choice for electric cap manufacture. The drawbacks would be the poor elevated temperature storage and the toxic nature of mercury and subsequent problems in loading.

MANUFACTURE:

In a pint large mouth fruit jar or 500 ml beaker place either 2 ml water and 10 ml 90%+ nitric acid. Water first of course. If 70% nitric acid is available then place 11.5 ml of it instead of the 90% in the pint jar. Add 1 1/4 gram of mercury.

Mercury should be available in thermometers, mercury switches and in old radio tubes.

CAUTION: Mercury fulminate manufacture generates fumes that are poisonous and this whole procedure should be done with very good ventilation.

The metal in the bottom of the jar should begin to bubble. If not add water drop wise to the solution until it does. A vigorous effervescent reaction takes place and red fumes are produced. They should be avoided as they are very poisonous. The mercury will all dissolve in the solution. If not heat gently but from a remote position until it does. After it is dissolved let it cool somewhat. Warm 90 cc of ethanol (90%+, "Everclear") in a quart jar. Add the metal/acid to this ethyl alcohol. The reaction should start within 5 minutes. The fumes put off by this mixture should be avoided. When the reaction is complete the fumes will have subsided and a grey powder will have settled to the bottom.

CAUTION: The fumes produced are poisonous and flammable and they should be avoided as well as flame should be kept away as fumes are highly flammable too!

Filter the grey powder out of the liquid.

CAUTION: The grey powder is the explosive and shock, friction and flame or heat should be avoided! Contact with the crystals should be avoided as the free mercury still poses a health problem!

These grey mercury fulminate crystals should be washed with 60 ml ethyl alcohol. Allow the crystals to dry by spreading them out gently. These dry mercury fulminate crystals are then ready to use. This explosive can safely be stored under water and these crystals could be mixed with 200 ml distilled water and stored until needed.

LEAD PICRATE

DETONATION VELOCITY - 4400 M/sec.

SENSITIVITY - This primary is very sensitive to shock friction and heat or flame. This sensitivity is high and care should be used in handling.

BEHAVIOR TO FLAME - Burns violently and sometimes detonates even in small quantities.

This is a good choice. The precursors to lead picrate and picric acid, lead monoxide and methanol. PA can be used as the base charge in the caps therefore reducing problems and simplification of production. It is not nearly as good a primary explosive as H.M.T.D. or D.D.N.P. but will work and is simple to make. Litharge, picric acid and methanol is all that is needed to make this one. This is a very dense heavy primary due to the lead in it's makeup. So from a cap volume use it in the same class as all the other primaries in this publication.

MANUFACTURE:

In a shallow glass dish, dissolve two grams of picric acid (see PA section) in ten ml of methanol. All stirring should be done with a teflon or wooden stirrer. Slowly while stirring add two grams of litharge (lead monoxide, white lead litharge-plumbing supply stores) to the methanol/PA solution.

CAUTION: At this point this is a primary explosive. Keep away from flame. Continue stirring mixture until all the alcohol has evaporated. When this happens the mixture will suddenly thicken. Stir the mixture occasionally to stop any lumps from forming.

CAUTION: Beware of drying material forming on the inside of the container. This material will be shock, flame and friction sensitive.

Spread this lead picrate in a flat shallow pan to dry. If possible dry the mixture on a hot water bath for two hours. This will ultimately give a better product with more stability.

NITROGEN SULFIDE

FRICION SENSITIVITY - Very sensitive to friction great care would be needed to produce this compound.

BEHAVIOR TO FLAME - Small quantities (less than one gram) deflagrate with a puff and larger sizes will detonate.

CHARGE WEIGHT - 2.0 Grams in 3/8 copper tubing only.

Nitrogen sulfide is a dangerous compound to make. It is sensitive to friction and heat. Mercury fulminate is much safer to use from the friction aspect. This compound is more powerful than mercury fulminate but with slightly less brisance. Storage stability is good for "straight" nitrogen sulfide. In the proper mixture with potassium chlorate the primary explosive is not stable @50 degrees C. for long periods of time. Heat can and will cause detonations. It is however despite these problems, easily prepared from common ingredients. This preparation is a simple one, with a variety of raw materials. As good a primary explosive as lead picrate. The recommended filler with this primary explosive is nitrogen sulfide 80% and completely dry potassium chlorate 20%. This is mixed and 2 grams are loaded over the charge and pressed on top the base charge. Better primary explosives can be had but this one is easy and expedient.

MANUFACTURE:

Place 100 grams of finely powdered sulfur (brimstone: garden supply store, pharmacy, industrial chemical supply) is placed in a tall narrow flask or narrow necked bottle equipped with a two hole stopper and placed in a frying pan filled with oil and heated until the sulfur melts (215 degrees C., 420 degrees F.). In this place a hose from the chlorine gas generator. This generator is a gallon jar with either liquid laundry bleach (5.25% Sodium hypochlorite aqueous solution) or 31% hydrochloric (Muriatic acid, swimming pool supply). to the bleach (total 1.2

gallons) is added in small portions sodium bisulfite ("Saniflush": bathroom cleaners, sodium acid sulfite, swimming pool additive). This generation with the bleach/ bisulfite generator should have the bleach split into three equal amounts and reacted with the bisulfite one at a time. The second and third. 4 gallon refill should be done only after the green gas is no longer generated by new sodium bisulfite additions. The spent bleach is poured out of the gallonjug. The second or third fill are poured into the jug the process repeated until all three 2/5 gallon bleach solutions are reacted and the chlorine bubbled through the molten sulfur. To 255 grams hydrochloric acid is added 53 grams manganese dioxide (black manganese oxide: dry cell battery mfg., phosphating solutions, steel mfg.) in small portions. This is done in small additions until all the manganese dioxide is dissolved and the chlorine has stopped it's bubbling.

CAUTION: Chlorine gas is toxic avoid contact and used with very good ventilation. Used as a war gas in WWI.

Immediately after the addition and beginning chlorine generation place a one hole stopper to which some stainless steel or plastic (heat resistant) tubing has been inserted in the hole. The other end of this hose directs the chlorine gas generated through the two hole stopper into the bottom of the now molten sulfur. The other hole of the two hole stopper has a hose inserted just through the stopper. The end of this hose is placed into a flask or narrow necked bottle cooled by a salted ice bath. This sulfur will begin to absorb the chlorine generated. This reaction forming sulfur dichloride. A total of 42 grams of chlorine need to be absorbed by the sulfur. As this chlorine is dissolved sulfur dichloride will begin to form. Sulfur is very soluble in sulfur chlorides and will begin to be dissolved in the chloride already formed. This sulfur chloride will vaporize and collect in the bottle chilled by the salted ice bath. This is done until the temperature drops and begins to boil. Continue to pass the chlorine gas through the liquid. After all the chlorine has gone through the sulfur heat until the sulfur liquid no longer boils. Heat for another ten minutes and allow to cool. The last flask should have caught most of the sulfur dichloride liquid. Take the mixture off the heat and allow to cool. Dissolve 212 gram of this liquid in 1700 grams benzene (common industrial solvent).

CAUTION: Sulfur dichloride (Sulfur chloride) is a pungent oily liquid. All contact should be avoided! All steps of this process should be carried out with good ventilation. Benzene is a very dangerous liquid. Contact with the skin, breathing of the vapors are dangerous and should be avoided. Great care should be used when handling this known carcinogen. It is also highly flammable.

Filter this solution through a paper coffee filter. This filtering should remove nearly all the sulfur. The remaining liquid should have no solids in it. Then ammonia gas generator is set up and ammonia gas is bubbled through the solution. The ammonia generator (ammonium nitrate/lye) is described in TACC section of the primary explosive section of this book. A dark brown powdery powder will collect in the bottom as the ammonia bubbles through the liquid. Keep

bubbling the ammonia gas through the solution. Until this brown powder dissolves in the solution and a orangeyellow color is observed. Flocculent ammonia chloride crystals are seen in the liquid. Warm the benzene until it boils. Filter immediately through a filter with 200 grams fresh benzene. Add this benzene wash to the liquid just filtered (filtrate). Let this liquid evaporate until a mushy crystalline mass remains and filter. Let these crystals dry. These golden yellow to orange red are nitrogen sulfide.

CAUTION: This explosive is friction, flame and shock sensitive. Handle with the greatest care.

This powder must be pressed into the cap using the apparatus shown in the cap manufacture section for proper performance and moisture should be avoided. Contamination with sulfur in mixtures with potassium chlorate could very well cause an explosion!

SILVER FULMINATE

FRICION SENSITIVITY - Extremely friction sensitive! Should not be used if other primary explosives can be made.

BEHAVIOR TO FLAME - Single crystals explode violently. Larger amounts than given in the process below should not be made.

CHARGE WEIGHT - 1.0 G. compound cap

Silver fulminate (SF) is an extremely dangerous compound. Friction flame and sometimes contact with the dried product will cause it's detonation. It's performance is fair and the acquisition of the raw ingredients is simple. Never used due to the extremely unstable nature of SF. If other primary explosive options existed they would be better choice than this one. To use this primary explosive it must be mixed with tapioca starch (flour) to reduce this explosive extreme sensitivity. It is easily obtained due to the abundance of silver (coins, powder, ingots). Small batches of SF should be made with protective barricades between the operator and the reaction vessel. Again this explosive is dangerous and should be avoided if at all possible.

MANUFACTURE:

Place 6 ml nitric acid (1.42 G/cc common technical grade acid or "watered" down stronger acid) in a 100 ml pyrex beaker containing 1.2 ml water and heated to 95-100 degrees F.. Place one gram of silver, (coins, bars, powder) in this acid solution.

CAUTION: This addition should be done with excellent ventilation as the nitrogen dioxide fumes generated are very toxic even in small quantities!

This will begin to bubble as the silver is dissolved. This will form silver nitrate in a very acid solution. When the silver dissolves (gentle heating may be necessary to get all the mercury to dissolve). In a 500 ml beaker surrounded by an ice bath

place 15 ml 95% + ethyl alcohol ("Everclear" or redistilled concentrate whiskey etc.) and add the silver/acid solution to the liquid not allowing the temperature to rise above 65 degrees C.

CAUTION: This addition will cause the generation of poison gases and should be done with good ventilation.

A vigorous reaction will take place with this addition. Dense white poisonous fumes are given off. As time lapses, the density of these fumes will diminish. The reaction will subside in 20-25 minutes. When the foaming reaction ceases, pour this solution into 200 ml water. The white crystals are then allowed to settle and the clear liquid on top poured off. Add 0.25 gram tapioca starch to the white crystals and filter the solution. The crystals filtered out through a paper towel or drip coffee filter. They are then washed with 30 cc ethanol. These crystals are then used in an area away from sunlight.

CAUTION: This white powder is extremely flame, friction and light sensitive. Friction and impacts should be avoided and the material should be expected to explode at any time. Again this explosive is dangerous even for someone with much laboratory experience. This composition should be avoided and it's manufacture undertaken only as a last resort.

NITROMANNITE (Mannite hexanitrate)

DETONATION VELOCITY - 7000m/sec. @1.50 G/cc

FRICTION SENSITIVITY - As sensitive as nitroglycerin. The sensitivity is greater when between two hard surfaces.

BEHAVIOR TO FLAME - Will deflagrate under some conditions but local overheating from a match will cause detonation.

Mannite is a simple sugar. It finds wide use as a baby laxative, in artificial resins and as a pharmaceutical dilutant. It can, through nitration, become a superb base charge for blasting caps. This explosive is attractive because of it's power and performance characteristics. It has a high detonation rate, good brisance and initiation properties. It has several bad points. It requires concentrated acid (90%+) which is harder to prepare. It has elevated temperature storage problems with greatly increased sensitivity. This instability is brought on by storage at 75 degrees C. for two days. The mixture of tetracene and nitromannite (40/60) will give a powerful brisant primary explosive that detonates from moderate heat. Nitromannite is usually used straight as a base charge for blasting caps with 0.75 gram charge weights giving 100% reliability.

MANUFACTURE:

One hundred grams of nitric acid (Specific Gravity 1.51 G/cc) is placed in a quart jar or 800-1000 ml beaker. This is cooled by surrounding with a salted ice bath. 20.2 G. mannite is added in very small portions with gentle stirring. The

temperature should be kept below 0 degrees C. This is done by controlling the amount of time between the additions of the mannite. When the temperature approaches 0 degrees C. stop additions until the temperature has fallen some. After all the mannite has been added 200 G. 98% sulfuric acid is added dropwise to the solution. This is done while the mixture is stirred and with the temperature below 0 degrees C, temperature is again maintained by the speed of the addition. When the temperature rises close to 0 degrees stop the addition and allow the liquid reaction mass to cool before addition is resumed. Completing the addition of sulfuric acid the porridge-like mixture is stirred for 5 minutes and then filtered. This filtering can be done through hardened filter paper or 10 drip coffee filters (simultaneously). This product is washed with water and then washed with 5% sodium bicarbonate/water solution. Then the crystals are washed again with water. This crude product is then dissolved in boiling alcohol with as much dissolved as possible. Place this container in a refrigerator and when chilled filter through one drip coffee filter. The liquid remaining is reheated and water is added until a turbidity is seen (churning of the solution). Allow to cool and filter the crystals out of this solution. Completely dry the material and it is ready to use. Could be kept under water for safety until ready to use.

R.D.X. (Cyclotrimethylenetrinitramine)

DETONATION VELOCITY - 5830 M/sec. @1.00 G/cc

8360 M/sec. @1.67 G/cc

FRICTION SENSITIVITY - Slightly less sensitive than T.N.T. but with 180% the actual power. Particle size reduction should be done while wet.

BEHAVIOR TO FLAME - Burns with a yellow flame. Very seldom if ever transforms into detonation.

R.D.X. is a powerful explosive. It is very stable and has good storage properties. It is widely used commercially as a base explosive charge in detonators and blasting caps. One gram of R.D.X. in a cap with a primary charge will detonate anything a #8 cap will detonate. For the process to make R.D.X. from camp stove fuel - see chapter 2 in "Kitchen Improvised Plastic Explosives" This process while not simple will produce a good product. This is a superb explosive and can find many uses. P.E.T.N. is the only explosive that really is close to being as good a base charge explosive as R.D.X. In "Kitchen Improvised Plastic Explosives II" there is a new process to manufacture R.D.X. Below is a process for extracting this explosive powder from "C-4" plastique explosive. The product will be as good as any for base charge use. C-4 could also be used as a base charge as is!

EXTRACTION - Take a 1/2 pound block of C-4 and place in a container impervious to gasoline. Add one liter of gasoline. Let this gasoline soak the block until the plasticizers are dissolved (just a powder is settled on the bottom of container) and filter the gasoline. Save the powder and discard the gasoline filtrate. Let this

powder dry until it is free of gasoline. This should yield 206 grams of R.D.X.. This powder is ready to use as a base charge in a improvised blasting cap.

MANUFACTURE:

Cyclotrimethylenetrinitramine or cyclonite is manufactured in bulk by nitration of hexamethylenetetramine (methenamine, hexamine, etc.) with strong red 100 % nitric acid. The hardest part of this reaction is obtaining this red nitric acid. It will most likely have to be made. More on this later.

Hexamine Manufacture:

The hexamine or methenamine can usually be bought in bulk quantities or hexamine fuel bars for camp stoves can be used, but they end up being very expensive. To use the fuel bars they need to be powdered before hand. The hexamine can also be made with common ammonia water (5%) and the commonly available 37% formaldehyde solution. To make this component, place 400 g. of clear ammonia water in a shallow pyrex dish. To this add 54 g. of the formaldehyde solution to the ammonia water.

Allow this to evaporate and when the crystals are all that remains in the pan, place the pan in the oven on the lowest heat that the oven has. This should be done only for a moment or so to drive off any remaining water. These crystals are scraped up and placed in an airtight jar to store them until they are to be used.

Red Nitric Acid Manufacture:

To make the red nitric acid, you will need to buy a retort with a ground glass stopper. In the retort, place 32 grams of sulfuric acid (98-100%) and to this add 68 g. of potassium nitrate or 58 g. of sodium nitrate. Gently heating this retort will generate a red gas called nitrogen trioxide. This gas is highly poisonous and this step as with all other steps should be done with good ventilation.

This nitric acid that is formed will collect in the neck of the retort and form droplets that will run down the inside of the neck of the retort and should be caught in a beaker cooled by being surrounded by ice water. This should be heated until no more collects in the neck of the retort and the nitric acid quits dripping out of the neck into the beaker. This acid should be stored until enough acid is generated to produce the required size batch which is determined by the person producing the explosive.

RDX Nitration Reaction

Of course the batch can be bigger or smaller but the same ratios should be maintained. To make the RDX, place 550 g. of the nitric acid produced by the above procedure in a 1000 ml. beaker in a salted ice bath. 50 g. of hexamine (methamine) is added in small portions making sure that the temperature of the acid does not go above 30 deg. C.. This temperature can be monitored by placing a thermometer directly in the acid mixture.

During this procedure, a vigorous stirring should be maintained. If the temperature approaches 30 deg. C., immediately stop the addition of the hexamine until the temperature drops to an acceptable level. After the addition is complete, continue the stirring and allow the temperature to drop to 0 deg. C. and allow it to stay there for 20 minutes continuing the vigorous stirring.

After the 20 minutes are up, pour this acid-hexamine mixture into 1000 ml of finely crushed ice and water. Crystals should form and are filtered out of the liquid. The crystals that are filtered out are RDX and will need to have all traces of the acid removed.

To remove the traces of acid, first wash these crystals by putting them in ice water and shaking and refiltering. These crystals are then placed in a little boiling water and filtered. Place them in some warm water and check the acidity for the resultant suspension with pH paper. You want them to read between 6 and 7 on the pH scale. If there is still acid in these crystals, reboil them in fresh water until the acid is removed, checking to see if the paper reads between 6 and 7. Actually the closer to 7 the better.

To be safe, these crystals should be stored water wet until ready for use. This explosive is much more powerful than TNT. To use, these will need to be dried for some manufacture processes in this book. To dry these crystals, place them in a pan and spread them out and allow the water to evaporate off them until they are completely dry.

This explosive will detonate in this dry form when pressed into a mold to a density of 1.55 g./cc at a velocity of 8550 M./sec..

PETN (Pentaerythrite Tetranitrate)

DETONATION VELOCITY - 5830 M/sec. @ 1.09 G/cc.

7490 M/sec. @ 1.51 G/cc.

8300 M/sec. @ 1.77 G/cc.

FRICITION SENSITIVITY - Sensitive to friction between two hard surfaces

BEHAVIOR TO FLAME - Burns quietly after melting with a slightly luminous flame.

PETN is a powerful explosive. It's power is slightly greater than R.D.X. and it is slightly more sensitive to initiation. It is powerful, stable, safe and efficient for the manufacture of improvised blasting caps. PETN is found, in it's common form, as the filler in detonating cord (E-cord etc.). If a person had access to this detonating cord he could salvage the PETN out of the cord by splitting it and simply scraping out the filler with a pocket knife or similar tool. The larger primer cord could yield as much as 1.7 lb. (771 grams) of the powder per hundred feet of cord. If access was available this method would be much better and easier than actual manufacture. This manufacture requires the acquisition of fuming nitric acid. This

can be bought or made. For manufacture see chapter 2 of "Kitchen Improvised Plastic Explosives" Then the pentaerythrite must be obtained. It is available and is used in the paint and varnish industries as well as in the manufacture of synthetic resins. It is cheap, but could raise a few questions in it's acquisition. Sulfuric acid is available from cleaning supply houses and as some generic drain openers. This is one of the best choices for cap base charge explosives. It has great power and will, in a properly constructed cap, give super reliable detonation initiation.

MANUFACTURE:

In a quart jar or a 1000 ml beaker place 400 ml 99% strong white nitric acid. This acid can be bought from a laboratory supply or the fuming red acid produced in process in "Kitchen Improvised Plastic Explosives". This fuming red acid will need to have the excess nitrogen dioxide purged until it is clear. This is done by adding 2-3 grams urea (45-0-0 fertilizer will work) to the acid. The mixture should clear up and lose the red tint. If not, warm the acid in the beaker and bubble dry air through the mixture. With the clear, white acid in the beaker place this beaker in a salted ice bath. Let it cool to below 0 degrees C.. Add with stirring 100 grams of pentaerythrite in small portions to the acid. The addition is done as such a speed that the temperature of the solution does not rise to more than 5 degrees C. When the addition is complete stir the acid/pentaerythrite solution for 15 more minutes. The crystals of the product will probably already have formed somewhat in the liquid.

CAUTION: At this point the crystals are a high explosive and should be treated with respect.

This solution is then poured into a previously prepared gallon jar with 2 1/2 quarts of cracked ice and water. PETN will immediately form and should be filtered out of the solution through a paper towel or drip coffee filters. This should yield 220 grams. This product needs purification. Wash these crystals 3 times with water and then wash 1 time with a 5% sodium bicarbonate solution. Wash once more with water and then dissolve the crystals in hot acetone. Let this cool and the crystals will begin to fall out of solution. Add an equal volume of water to the acetone and the crystals will fall out of solution. Filter these crystals out and wash with methanol and let them dry. This PETN can be dried by either simply air drying for 24 hours or by drying in a hot water bath. These dried crystals are ready to use.

PICRIC ACID (trinitrophenol)

DETONATION VELOCITY - 4965 M/sec. @0.97 G/cc

6510 M/sec. @1.4 G/cc

7480 M/sec. @1.7 G/cc

FRICTION SENSITIVITY - More sensitive than T.N.T. but not substantially. Metals

should be coated to ensure the formation of picrate salts. Coating copper tubing or rifle cases with urethane plastic spray could prevent this from happening.

BEHAVIOR TO FLAME - Small quantities burn with a sooty flame after melting. Large quantities can transform the deflagration into detonation in some rare instances.

Picric acid is a good choice of explosive base charges in caps. Relative performance would be 120% (T.N.T.=100%). Nitrophenols have been with us for a while. Their creation from nitric acid and animal horn was the first of these discoveries. Nearly 100 years passed before researchers found out it could be made to explode. It is this relative insensitivity of the material and it's good primary sensitivity yield many used for this explosive. It is very stable in storage with samples from late 1800's showing little signs of deterioration. The only reason that we do not use PA as an explosive in modern ordinance is mostly from a cost standpoint. PA can be reacted with ammonium hydroxide to form "Explosive D". This is a superb shaped charge explosive and does find some demolition and specialized munition loading. Brisance is very high for picric acid and it will detonate easily from the primary explosives in the primary section of the publication. Picric acid is poisonous and all contact should be avoided. This process uses the phenol byproduct used everyday as an analgesic. Aspirin (acetylsalicylic acid) in it's purified form, sulfuric acid (98%) and sodium or potassium nitrate are the ingredients. Aspirin is available in any drug store or supermarket. Sulfuric acid is available at janitorial supply houses and plumbing suppliers. Battery acid that has been boiled until white fumes appear will also work. Sodium or potassium nitrate should be available from hobby stores and as stump remover in garden stores. The methanol carrier can be found at hardware stores and from janitorial supplies. Caution should be used in handling the product of the process below. Contact should be avoided. Contact includes breathing dust and exposure of the skin or any other part of the body. Liver and kidney failure could result. Use gloves and retire any utensil that will be used in the process.

MANUFACTURE:

Crush 100 aspirin tablets. Powder these crushed aspirin tablets. To them add 500 ml alcohol (95%) This alcohol will dissolve the acetylsalicylic acid in the aspirin and leave all the pill fillers in solid form in the bottom. Stir this aspirin/alcohol liquid for five minutes while warming it gently. Filter the warm liquid and keep the filtrate (liquid) and discard the remainder. Evaporate this liquid in a shallow pan in a hot water or oil bath. Collect the dried acetylsalicylic acid crystals. Place 700 ml sulfuric acid in the bottom of a gallon jar. To this acid is added the acetylsalicylic acid crystals from above. This gallon jar is placed in an oil bath (electric frying pan would be easiest but flame heat will work). This is heated with stirring until all the crystals are dissolved in the hot acid. The crystals having dissolved will allow you to begin the addition of sodium or potassium nitrate. This addition is done in three portions, allowing the acid mixture to cool some between additions.

CAUTION: The addition of the nitrate to the hot acid will generate nitrogen dioxide which is a deadly poison. This step should be carried out with excellent ventilation!

This liquid will react vigorously, as the 75 grams of either of the nitrates are added to the solution in this three part addition. The solution should turn red and then back to the yellow orange color. After the additions let the solution cool to room temperature while stirring occasionally. Pour this room temperature solution into 1500 ml of cracked ice and water (1/4 ice). The product will precipitate out immediately as a brilliant yellow compound. Filter through a paper towel or 5 drip coffee filters in a funnel. Wash these crystals with 450 ml cold water. Discard the filtrate (liquid remaining after filtering). The yellow crystals are trinitrophenol. These crystals need to be dried for 3 hours on a boiling water bath or on a 105 degree C. oil bath. They are then ready to load into a detonator as a base explosive. Avoid contact with the yellow composition as it is highly poisonous. Wear gloves (viton) when working with this explosive.

M.M.A.N. (Monomethylamine nitrate)

DETONATION VELOCITY - 6100 M/sec. @ 1.2 G/cc

6600 M/sec. @ 1.4 G / cc

FRICITION SENSITIVITY - Very insensitive. Similar to T.N.T.

BEHAVIOR TO FLAME - Burns if heated to 370-390 degrees C. and will burn completely in 6-8 seconds.

M.M.A.N. is a powerful explosive with 112-120% the power of T.N.T. with a greater detonation rate. This explosive is not as sensitive as others in this publication to primary explosive requiring 2 G. mercury fulminate or 1.25 grams of H.M.T.D. Methylamine is a basic building block of modern chemistry. It is an intermediary for hundreds of more common chemicals. It is easily obtained or purchased cheaply. Nitric acid does not require highly concentrations with as low as 20% acid strength working perfectly. This is a good feature as requirements for explosives made with concentrated acids take time to produce and cannot be produced as fast or cheaply. This explosive is simple enough that it would require little experience and few setups in a lab. This explosive is very hygroscopic. It will absorb its weight in water at a relative humidity of 50% in 21 days. The other drawback of this explosive is the fact that it requires larger quantities of primary explosive as other base explosives. Both are acceptable and the hygroscopic nature of the salt can be controlled by loading caps on "dry days" of low humidity. These caps should also be dipped into molten wax to ensure their "waterproofness". This explosive is best used in a cap made with 3/8" tubing because 5 grams of this explosive are required. This will give a detonator 3/8" x 2-3/4". This cap should have the primary loaded first as the base explosive does not need the high density that the primary needs for maximum performance. Load this base charge explosive to a density of 1.2 G/cc. Higher densities will cause the explosive to become insensitive

to the primary explosive. This cap should detonate most explosives and will be a great deal more powerful than a #10 blasting cap.

MANUFACTURE:

Place 250 ml of 33% methylamine aqueous solution in a stainless bowl or beaker. Add in four portions either 832 G. 70% nitric acid, 971 G. 60% nitric acid or 583 G. 100% nitric acid + 250 ml water. A good deal of heat will be generated by this neutralization. The solution will boil due to the heat. Allow the heat from the previous additions to subside before the next addition is made. After the additions have been made check the solution with PH paper (e. mark brand) from your lab supply store. If the PH is above 7 add acid 1/4 teaspoon at a time until the PH is between 6 and 7. If when checked the PH is 6 or below then add methylamine solution until the PH rises to between 6 and 7. This liquid is then put in a vacuum flask with a stopper. This will be placed in a hot oil bath (frying pan filled with good cooking oil). The oil bath should be 75 degrees C. (167 degrees F.). The flask is hooked up to a vacuum source and the vacuum applied. The vacuum will allow the water's removal in a much quicker amount of time. The vacuum source can be an aspirator type (cost around \$5.00). This is the ideal source of vacuum. A gauge is placed in the line and the vacuum drawn at first recorded. This vacuum will remain the same until the water is all evaporated. At this point the vacuum suddenly will increase greatly. This signifies the end point. The crystals in the flask are scraped out in a dry (atmospheric humidity) room. This is placed in a sealed container to keep moisture out of the solutions. This is the explosive. It could be toxic if eaten in large quantities but at worst, prolonged handling of this explosive will give only a rash. The only thing to remember is to keep away from moisture and keep in a sealed container. Load large 3/8" diameter caps with 4-6 grams of MMAN as a base charge with large charges of primary explosives. Seal the caps immediately by dipping in hot molten wax. These caps are powerful and will take most of a forearm off a foolish person.

TETRANITRONAPHTHALENE (TeNN)

DETONATION VELOCITY - 7000 M/sec. @ 1.6 G/cc (In 1/4" aluminum Tube)

FRICITION SENSITIVITY - Similar to T.N.T.

BEHAVIOR TO FLAME - Rapid heating can cause detonations!

These yellow crystals are prepared by the nitration of naphthalene flakes in a two stage nitration. The product of the first stage is the dinitronaphthalene. This "di" product is nitrated to the "tetra". This is done in two different nitration steps. This product can be considered the equivalent of T.N.T. in power with a slightly greater detonation rate. This tetra compound is stable even at elevated "magazine" temperatures and is an explosive of greater power and brisance than T.N.T.. Has been proposed as an artillery shell filler. T.N.T. has been cheaper due to continuous manufacture processes. It is however a powerful explosive with detonator usage

promise. It has the same impact properties as does Tetryl with the same potential. It is easily made from naphthalene, nitric acid and sulfuric acid. These compounds are easy to come by and thus would make this a easily manufactured product. Naphthalene flakes, balls or powder are used as insecticides and are familiarly known as "Moth balls". Sulfuric acid is easily obtained from plumbing and janitorial supplies. Nitric acid can be made see "Kitchen Improvised Plastic Explosives" Recovery of spent acids in both steps will reduce acid demand and can be done by heating the spent acid until white fumes are produced.

CAUTION: Care should be taken to avoid all fumes from heated acid mixtures and that this spent acid being recovered is free of nitronaphthalene products. Failure to do this could result in a very violent explosion! Great care should be used to ensure the lack of remaining nitro compounds in the spent acid solutions. Caps should have a 1.5 G.+ charge of TeNN for best performance. This explosive should be loaded to a density of 1.6 G/cc. This explosive will melt around 200-210 C.

CAUTION: This meltable explosive should be used in its crystalline form. The melt loading should only be attempted by someone with chemistry lab experience. Rapid heating will most likely cause a high order detonation and fatalities! This heating would be done slowly as rapid heating could cause detonation. This melted compound could then be cast into the detonator case prior to loading the primary explosive. This could produce charges that required greater amounts of primary explosive to ensure detonation!

MANUFACTURE:

Tetranitronaphthalene is produced by nitration of naphthalene. Naphthalene is a coal tar or synthetic petrochemical. It is readily available in the form of moth balls, moth flakes or moth crystals. Place 64 grams in a 2 liter beaker of "pyrex" container. To this add 105 cc distilled water. Slowly add 287 grams (160 cc) concentrated sulfuric acid of a concentration of greater than 90% strength (Specific gravity 1.8).

CAUTION: Addition should always be acid to water and never water to acid. The acids used in this process are very dangerous and should be used with great care. Goggles and full protective gear should be worn. Fumes produced should be avoided at all costs. This whole process should be done under a vent hood or in a very well ventilated place!

The temperature of this acid mixture will rise immediately. To this is added 115 grams (81 cc) of 70% nitric acid. This mixed acid is allowed to cook to room temperature. 150 grams of naphthalene is added slowly with stirring in small portions over a three hour period while the temperature is allowed to rise to 50 degrees C. When all the naphthalene is added, the beaker or "Pyrex" container is heated to 55 degrees in a oil bath, which melts the crude mononitronaphthalene. The stirring is then stopped and the MNN allowed to solidify. This solid MNN is broken up off the top and placed in a second acid mixture. This acid mixture is prepared by placing 130 cc water in a 1000 cc beaker or "Pyrex" container. To it is

slowly, carefully added 293 G. sulfuric acid (162 ml) density 1.8 G/ cc. (95% +). This mixture will heat up when mixed and should be cooled to 25 degrees C. by placing in an ice bath. When the acid mixture is at 25 degrees 152 grams of potassium nitrate is added. The mixture is stirred vigorously and the addition of the MNN from above is begun. It is added in small quantities keeping the temperature between 38-45 degrees C. by the speed of the addition. During this addition (1 hour +), the temperature is not allowed to rise to over 45 degrees C. After one hour, the temperature is allowed to rise to 55 degrees C. and the stirring is continued. This is continued until the emulsion is replaced by the formation of MNN crystals. These crystals are then filtered out by a glass fiber filter (fiberglass). These crystals are washed six times with cold water and allowed to dry. These are then dissolved in boiling acetone. Not all will dissolve. Filter this solution while hot and allow to cool. Chill this solution and crystals will form. Filter out the crystals that form. Reduce the volume of the acetone by 1/2 and chill again and filter. Add the crystals together from these acetone recrystallization steps and allow to dry. These crystals will be a good grade of 1.8 Dinitrotaphalene. These crystals will be nitrated, in the process below, to the tetro form.

Place 750 ml fuming nitric acid, of 90% or greater strength (See Kitchen Improvised Plastic Explosives), in a two liter "pyrex" container or a 2000 ml beaker. Add to this very slowly and carefully 750 ml concentrated sulfuric acid. This acid mixture is stirred and cooled in a ice bath until the temperature drops below 20 degrees C. The 1.8, DNN from above is added in small quantities while the temperature is not allowed to rise above 20 degrees C. When all the DNN has been added, the temperature is allowed to rise slowly. Heat will need to be applied. This heating should be done such that the temperature rises from 20 to 80 degrees C. for three hours and then allowed to cool. The solid formed is filtered out and the filtrate (liquid remaining after filtering) drowned in twice it's volume of ice water. This step will drop more crystals out of the filtrate. These are filtered out and added to the crystals filtered out of the reaction mixture. These are then washed three times with water and then dissolved in hot from 95% ethanol. This alcohol is chilled and then the crystals formed are filtered out. This last step is not necessary, but highly desirable to give a very storage stable product.

These crystals are 1,3,6,8-tetranitronaphalene. They should be dried by heating in a shallow pyrex dish by the way of a hot water bath.

NITROGUANIDINE

DETONATION VELOCITY - 5630 M/sec. @ 1.0 G/cc.

7650 M/sec. @ 1.5 G/cc.

FRICTION SENSITIVITY - Very insensitive

BEHAVIOR TO FLAME - Melts with sublimation and decomposition.

Nitroguanidine is a powerful explosive. First made from bat guano, by extraction

and formation of guanidine nitrate and subsequent treatment of this nitrate with sulfuric acid (95% +) and filtration of the product. This explosive is similar in performance to picric acid and T.N.T.. While not being quite as brisant as these two explosives the ease of manufacture and lack of friction sensitivity make nitroguanidine an attractive choice for a blasting cap base charge explosive. It is a cool explosive and does not give a high temperature of detonation but gives a larger volume of gases upon detonation. This base charge explosive, should be loaded in the caps with the density not exceeding 1.35 G./cc. Excess loading densities will render the base charge undetonatable with 1.5 G. charges of H.M.T.D.. This explosive will work and work well and is very storage stable. Larger diameter cap containers (3/8" +) should be used to ensure propagation of the detonation through the entire cap. Given below is the manufacture techniques for production of nitroguanidine. This procedure will work well but is rather lengthy and labor intensive.

MANUFACTURE:

Obtain two clay flower pots with a small hole in their bottoms. Fitted to one of these is stainless steel tubing. A refractory made from "firebrick" and fired by charcoal should be built. The flower pots will need to fit into this refractory and have ample room around them to pack the charcoal. An air blower (e.g. hairdryer, vacuum cleaner is hooked up to blow air through the coal to generate the heat needed. In the bottom flower-pot, a stainless steel screen will be needed to keep from clogging the stainless steel tubing from the ammonia inlet tube. Place 200 grams of calcium carbonate (Limestone, chalk) in the bottom flower pot, with the stainless tubing attached. Place the other flowerpot upside down directly on top of the bottom pot. Place this in the refractory furnace and place a pyrometer or high temperature thermometer into the hole in the top clay flower pot. Start the furnace and blow air through the burning charcoal until the temperature inside the pots reaches 700 degrees C.. At this time begin to pass ammonia gas through the stainless tubing into the lime inside. The temperature should never go over 820 degrees C. as the lime will decompose. The ammonia generator the gas generator in the TACC section. The amounts needed in the generator are 170 G. ammonium nitrate fertilizer, 100 G. sodium hydroxide and adding 100 ml water to the mixture. This water addition would be done in small portions to ensure the absorption of the gas by the calcium carbonate. This gas needs to be generated slowly! When all the ammonium nitrate has been added and the gas ceases to generate from the generator deprive the charcoal of oxygen to extinguish the flame. Let the refractory furnace cool and remove the flowerpots from it. The black material in the bottom is calcium cyanamide.

Place 216 grams of urea in a stainless steel pan. Heat until it begins to melt. Add in small portions 1300 grams ammonium nitrate.

CAUTION: This is dangerous and extreme care should be used in this step. This mixture could explode if allowed to burn. Water should be used if a fire does break

out by immediate dilution and quenching of the reaction mixture!!

Keep the temperature of the melt at 120 degrees centigrade. When the addition of the ammonium nitrate is complete and the mixture is liquid and at 120 degrees C. the calcium cyanamide from above is added in portions over a twenty minute period. This mixture's temperature is held at 120 degrees C. for two hours and then diluted with 720 ml water. This liquid is heated to 95 degrees C. and then filtered through several coffee filters or a "fast" filter paper. The liquid thus obtained is allowed to cool to 25 degrees C. and then the crystals formed are filtered out. The liquid is reduced to 1/2 its volume by boiling. It is cooled and filtered and the crystals obtained are added to those from the first filtration. These crystals are washed with 40 ml cold water. They are then dried in a shallow pyrex dish while heated in a hot oil bath at 110 degrees C. for two hours. These crystals are guanidine nitrate (90% purity).

Immerse a one liter flask, containing 500 ml. concentrated sulfuric acid, in cracked ice. This acid is stirred until the temperature drops to 10 degrees C. or less. In small portions, add 400 grams of dry guanidine nitrate to the acid with stirring to keep the temperature below 11 degrees C.. When all the guanidine nitrate is dissolved, pour the now milky liquid into three liters of cracked ice and water. Let this stand until the nitroguanidine is completely crystallized out of the liquid. Filter these crystals out and dissolve in four liters of boiling water (distilled if possible). Allow to cool by standing overnight and filter the crystals out. Dry these crystals by heating gently in a container placed in a pan of boiling water. This dried material is then ready to store in a plastic container or to load into finished caps.

COMPOSITION C-4

C-4 was developed because of the hardening and toxicity that made C-3 unreliable and dangerous due to the dinitrotolulene. The following composition is the standardized plastique explosive as adopted by the armed forces:

RDX 91.0%

Polyisobutylene 2.1%

Motor Oil 1.6%

Di-(2-ethylhexyl)sebecate 5.3%

The last three ingredients are dissolved in unleaded gasoline. The RDX explosive base is then added to the gasoline-plasticizer and the resultant mass is allowed to evaporate until the gasoline is completely gone (this can be done quickly and efficiently under a vacuum). The final product should be dirty white to light brown in color.

It should have no odor and have a density of 1.59 gm/cc. It does not harden at -57 deg. C. and does not undergo exudation at 77 deg. C.. It can be reliably detonated with a #6 blasting cap. The Brisance of this explosive (ability to do work or

fragment munitions) is 120 % greater than C-4 is the best plastique explosive available in the world and probably will remain so for quite some time. This is the #1 demolition explosive in the world and if you've never seen this stuff used it is absolutely amazing. The detonation velocity of C-4 is 8100 M/sec..

PLASTIQUE EXPLOSIVE FROM BLEACH

This explosive is a potassium chlorate explosive. This explosive and explosives of similar composition were used in World War I as the main explosive filler in grenades, land mines, and mortar rounds used by French, German and some other forces involved in that conflict.

These explosives are relatively safe to manufacture. One should strive to make sure these explosives are free of sulfur, sulfides, and picric acid. The presence of these compounds result in mixtures that are or can become highly sensitive and possibly decompose explosively while in storage.

The manufacture of this explosive from bleach is given just as an expedient method. This method of manufacturing potassium chlorate is not economical due to the amount of energy used to boil the solution and cause the 'dissociation' reaction to take place. This procedure does work and yields a relatively pure and sulfide free product.

These explosives are very cap sensitive and require only a #3 cap for initiating detonation. To manufacture potassium chlorate from bleach (5.25% sodium hypochlorite solution) obtain a heat source (hot plate, stove etc.) a battery hydrometer, a large pyrex or enameled steel container (to weigh chemicals), and some potassium chloride (sold as salt substitute).

Take one gallon of bleach and place it in the container and begin heating it. While this solution heats, weigh-out 63 g. potassium chloride and add this to the bleach being heated. Bring this solution to a boil and boil until when checked with a hydrometer, the reading is 1.3 (if a battery hydrometer is used it should read full charge). When the reading is 1.3, take the solution and let it cool in the refrigerator until it is between room temperature and 0 deg. C..

Filter out the crystals that have formed and save them. Boil the solution again until it reads 1.3 on the hydrometer and again cool the solution. Filter out the crystals that are formed and save them. Boil this solution again and cool as before. Filter and save the crystals. Take these crystals that have been saved and mix them with distilled water in the following proportions: 56 g. per 100 ml. distilled water. Heat this solution until it boils and allow it to cool.

Filter the solution and save the crystals that form upon cooling. The process of purification is called fractional crystallization. These crystals should be relatively pure potassium chlorate. Powder these to the consistency of face powder (400 mesh) and heat gently to drive off all moisture.

Melt five parts vaseline and five parts wax. Dissolve this in white gasoline (camp stove gasoline) and pour this liquid on 90 parts potassium chlorate (the crystals from the above operation) in a plastic bowl. Knead this liquid into the potassium chlorate until intimately mixed. Allow all the gasoline to evaporate. Place this explosive in a cool dry place.

Avoid friction and sulfur, sulfides and phosphorous compounds. This explosive is best molded to the desired shape and density (1.3 g./cc) and dipped in wax to water-proof. These block type charges guarantee the highest detonation velocity. This explosive is really not suited to use in shaped charge applications due to its relatively low detonation velocity. It is comparable to 40% ammonia dynamite and can be considered the same for the sake of charge computation.

If the potassium chlorate is bought and not made, it is put into the manufacture process in the powdering stages preceding the addition of the wax-vaseline mixture. This explosive is brisant and powerful. The addition of 2-3 % aluminum powder increases its blast effect. Detonation velocity is 3300 M/sec.

PLASTIC EXPLOSIVE FROM SWIMMING POOL CHLORINATING COMPOUND (HTH)

This explosive is a chlorate explosive from bleach. This method of production of potassium or sodium chlorate is easier and yields a more pure product than does the plastique explosive from bleach process. In this reaction the HTH (calcium hypochlorite-CaClO) is mixed with water and heated with either sodium chloride (table salt, rock salt) or potassium chloride (salt substitute). The latter of these salts is the salt of choice due to the easy crystalization of the potassium chlorate.

This mixture will need to be boiled to ensure complete reaction of the ingredients. Obtain some HTH swimming pool chlorination compound or equivalent (usually 65% calcium hypochlorite). As with the bleach, it is also a dissociation reaction. In a large pyrex glass or enameled steel container place 1200 g. HTH and 220 g. potassium chloride or 159 g. sodium chloride.

Add enough boiling water to dissolve the powder and boil this solution. A chalky substance (calcium chloride) will be formed. When the formation of this chalky substance is no longer formed, the solution is filtered while boiling hot. If potassium chloride was used, potassium chlorate will be formed. This potassium chlorate will drop out or crystalize as the clear liquid left after filtering cools. These crystals are filtered out when the solution reaches room temperature.

If the sodium chloride salt was used this clear filtrate (clear liquid after filtration) will need to have all water evaporated. This will leave crystals which should be saved. These crystals should be heated in a slightly warm oven in a pyrex dish to drive off all traces of water (40-75 deg.C.). These crystals are ground to a very fine powder (400 mesh).

The potassium chloride is the salt to use as the resulting product will crystallize out

of solution as it cools. If the sodium chloride salt is used in the initial step, the crystallization is much more time consuming and it will have a tendency to cake and has a slightly lower detonation velocity. The powdered and completely dry chlorate crystals are kneaded together with vaseline in plastic bowl.

ALL CHLORATE BASED EXPLOSIVES ARE SENSITIVE TO FRICTION, AND SHOCK, AND THESE SHOULD BE AVOIDED

This explosive is composed of the following:

Potassium or sodium chlorate 90%

Vaseline 10%

The detonation velocity can be raised to a slight extent by the addition of 2-3% aluminum powder substituted for 2-3% of the vaseline. The addition of this aluminum will give this explosive a bright flash if set off at night which will ruin night vision for a short while. The detonation velocity of this explosive is approximately 3200 M/sec. for the potassium salt and 2900 M/sec. for the sodium salt based explosive.

PLASTIQUE EXPLOSIVE FROM TABLE SALT

This explosive is perhaps the most easily manufactured of the chlorate based explosives. Sodium chlorate is the product because rock salt is the major starting ingredient. This process would work equally as if potassium chlorate were used instead of the sodium chloride (rock salt).

The sodium chlorate is the salt I will cover due to the relatively simple acquisition of the main ingredient. The resulting explosive made from this process would serve as a good cheap blasting explosive and will compare favorably with 30% straight dynamite in power and blasting efficiency.

This explosive can be considered the same as 30% straight dynamite in all charge computation. These explosives and similar compositions were used to some extent in World War I by European forces engaged in conflict. It was used as a grenade and land mine filler. Its only drawback is its hygroscopic nature (tendency to absorb atmospheric moisture).

These explosives also have a relatively critical loading density. These should be used at a loading density of 1.3 g./cc. If the density is not maintained, unreliable or incomplete detonation will take place. These shortcomings are easily overcome by coating the finished explosive products with molten wax and loading this explosive to the proper density. This explosive is not good for shaped charge use due to its low detonation rate (2900 M/sec.).

The major part of the manufacture of this explosive from rock salt is the cell reaction where D/C current changes the sodium chloride to chlorate by adding oxygen by electrolysis of a saturated brine solution. The reaction takes place as

follows:

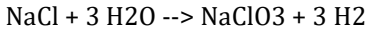

In this reaction the sodium chloride (NaCl) takes the water's oxygen and releases its hydrogen as a gas. This explosive gas must be vented as sparks or open flame may very well cause a tremendous explosion. This type of process or reaction is called a 'cell' reaction. The cell should be constructed of concrete or stainless steel.

I won't give any definite sizes on the cell's construction because the size is relative to the power source. This cell would have to be large enough to allow the brine to circulate throughout the cell to insure as uniform a temperature as possible. The speed of the reaction depends on two variables. Current density is a very important factor in the speed of the reaction.

The advantages of high current densities are a faster and more efficient reaction. The disadvantages are that cooling is needed to carry away excess heat and the more powerful power sources are very expensive. For small operations, a battery charger can be used (automotive). This is the example I will use to explain the cell's setup and operation (10 amp/12 volt). The current density at the anode (+) and cathode (-) are critical.

This density should be 50 amps per square foot at the cathode and 30 amps per square foot at the anode. For a 10 amp battery charger power source, this would figure out to be 5 5/16" by 5 5/16" for the cathode. The anode would be 6 15/16" by 6 5/16". The anode is made of graphite or pressed charcoal and the cathode is made of steel plate (1/4").

These would need to be spaced relatively close together. This spacing is done with some type of non-conducting material such as glass rods. This spacing can be used to control the temperature to some extent. The closer together they are, the higher the temperature. These can be placed either horizontally or vertically although vertical placement of the anode and cathode would probably be the ideal set up as it would allow the hydrogen to escape more readily. The anode would be placed at the bottom if placed horizontally in the cell so that the chlorine released could readily mix with the sodium hydroxide formed at the cathode above it. As the current passes through, the cell chlorine is released at the anode and mixes with the sodium hydroxide formed at the cathode. Hydrogen is released at the cathode which should bubble out of the brine. This gas is explosive when mixed with air and proper precautions should be taken.

PROPER VENTILATION MUST BE USED WITH THIS OPERATION TO AVOID EXPLOSION.

Temperature control is left up to the builder of the cell. The temperature of the cell should be maintained at 56 deg. C. during the reaction. This can be done by the circulation of water through the cell in pipes. But the easiest way would be to get an adjustable thermostatic switch adjusted to shut the power source off until the

cell cools off. This temperature range could be from 59 deg. C. shut off to a 53 deg. C. start up. An hour meter would be used on the power source to measure the amount of time the current passes through the cell.

If the water-cooling coil design appeals to the manufacturer and an easily obtained cheap source of cool or cold water is available, this would be the quickest design to use. Again, a thermostatic type arrangement would be used to meter the cooling water through the cell. The cooling coils would best be made of stainless steel to overcome the corrosiveness of the salts although this is not entirely necessary. A thermostatic valve would be set to open when the brine electrolyte was heated above approximately 58 deg C. and set to close when the temperature fell to approximately 54 deg C..

Again, this would be the best and most efficient method and the waste heat could be used relatively easily to heat either a house or perhaps even a barn or shop. To run the cell, after the cell has been constructed and the concrete has been sealed and has set and cured for several weeks, is very simple. First, to seal the concrete I suggest Cactus Paint's CP 200 series, two component epoxy paint or an equivalent product.

To fill the cell, place 454 g. sodium chloride in the cell (rock salt is excellent here). Place four liters of distilled water into the cell with the salt. The liquid should cover the anode and the cathode completely with room to spare. Remember that some of the water will be used in the reaction. Thirty three grams of muratic acid, which should be available from a swimming pool supply store is then added to the liquid in the cell. BE CAREFUL WHEN HANDLING ANY ACID!!!

Then 7 grams of sodium dichromate and 9 grams of barium chloride is added. The cell is then ready to run if the plates are connected to their respective cables. These cables are best made of stainless steel (the most corrosion resistant available). The power supply is then hooked up and the cell is in operation. The power is best hooked up remotely to lessen the chance of explosion. Any time the cell runs it will be making hydrogen gas.

THIS GAS IS EXPLOSIVE WHEN MIXED WITH AIR AND ALL SPARKS, FLAME, AND ANY SOURCE OF IGNITION SHOULD BE KEPT WELL AWAY FROM THE CELL. THIS CELL SHOULD ONLY BE RUN WITH VERY GOOD VENTILATION.

The steel plate cathode should be hooked to the negative side of the power source and the anode hooked to the positive side. Again these are hooked to the power supply via stainless steel cables. This cell is then run at the proper temperature until 1800 amp-hours pass through (amount per pound of sodium chloride) the electrolyte.

The liquid in the cell is then removed and placed in an enameled steel container and boiled until crystals form on liquid. It is cooled and filtered, the crystals collected being saved. This is done twice and the remaining liquid saved for the next cell run. The process will become easier as each run is made. It is a good idea

to keep records on yields and varying methods to find out exactly the best process and yield. To purify these crystals place 200 grams in 100 ml distilled water. Boil the solution until crystals are seen on the surface. Let cool and filter as before. Save this liquid for the next cell run. These purified crystals are placed in a pyrex dish and placed in the oven at 50 deg C. for two hours to drive off all remaining water.

Ronald B. Brown's *Homemade Guns and Homemade Ammo* (1999, Breakout Productions) details this process much more thoroughly.

The explosive is ready to be made. The crystals of sodium chlorate are ground to a face powder consistency. Ninety grams of this sodium chlorate are kneaded with 10 grams of vaseline until a uniform mixture is obtained. This explosive is sensitive to shock, friction, and heat. These should be avoided at all cost. This explosive works best at a loading density of 1.3-1.4 g./cc. If this explosive is not used at this density, the detonation velocity will be low and detonation will be incomplete.

To load to a known density measure the volume of the container in which the explosive is to be loaded. This can be done by pouring water into the container until the container is filled. Then the water is measured and the total number of ml will equal the cc's of the container. Multiply this number times 1.3 and load that much explosive (in grams of course) into the container after the container has been dried of all water. This procedure should be used with all chlorate explosives (plastique explosive from bleach, plastique explosive from HTH). This explosive is cheap and relatively powerful and is a good explosive.

GUN COTTON

Gun cotton is one of the first modern explosives used in war. Nitroglycerin was more powerful, but much more dangerous to use. And, of course, it was one of the first real substitutes for black powder as a weapons propellant. You can nowadays buy military surplus smokeless powder (gun cotton) from any number of sources for about \$8-10 a pound. Probably cheaper than you can make it, and definitely of much more uniform quality and strength than you could make at home. If you buy smokeless powder to use for this, make sure that it's single and not double based powder. Double based contains nitroglycerin which will make you sick as a dog if you touch it. Single based is harmless to touch.

The information here came mainly from an old book called "Compressed gun cotton for military use with an introduction on Modern gun cotton, its manufacture, properties and analysis" by Max von Förster, 1886. It's presented as it is for the most part. Some archaic terminology and irrelevant information has been changed or deleted.

Also presented is a patent for making various types of explosives and propellants from smokeless powder. It's been edited for clarity and conciseness. You can see the whole patent here

PREREQUISITES FOR QUALITY GUN COTTON

1. The cotton must be pure white absorbent cotton.
2. The strongest acids available must be used. 1 part, by weight, nitric acid of specific gravity 1.485 and 3 parts sulphuric acid of specific gravity 1.84, the total weight of acid being 20 times that of the cotton.
3. After the first immersion, which lasts only a few minutes, the cotton must be steeped in a fresh mixture of acids in the same proportion.
4. The steeping must be continued for 48 hours.
5. The gun cotton must then be squeezed and thoroughly purified by washing in a stream of running water for several weeks, dipped in a solution of sodium carbonate (or baking soda) and again washed.

Unless these precautions are observed the products are not uniform. If any acid is left in the gun cotton it is liable to spontaneous decomposition, hence the need for careful washing.

The sulphuric acid acts simply to absorb the water already present in the commercial nitric acid and also that produced in the change, and thus serves to keep the nitric acid concentrated.

THE PROCESS

The acid mixture consists of 3 parts by weight of sulphuric acid, specific gravity of 1.84, to 1 part nitric acid, specific gravity of 1.48. The acids are slowly mixed together in small amounts and the mixture is allowed to stand for several hours to become cold.

About 12 gallons of the acid mixture is drawn off into a deep stoneware pan standing in cold water. The cotton, when cold, is weighed out in quantities of 1 lb. each, carried to the dipping pan and immersed, a pound at a time, in the acid, and stirred about for two or three minutes. It is then placed on a grate or perforated shelf, attached to the pan, the excess of acid is squeezed out with the stirrer and the cotton allowed to drain. Enough acid is added from the acid bottle to replace that which has been absorbed by the cotton, and more cotton is treated in the same way.

The cotton is next transferred to pots well covered, standing in a shallow trough containing water, and is covered with about 10 or 15 times its weight of acid, and allowed to remain about 48 hours.

The gun cotton is now washed by a stream of water and whirled about in the water in the washing vessel, so that it comes in contact with a large quantity of water, and its temperature is not raised appreciably. It is again drained in the centrifugal machine and the washing repeated. It is then soaked in stirring tanks for two or three weeks, and afterwards boiled in large vats. The purified gun cotton is transferred to the blender where it is shredded to a fine pulp and then transferred

to another tank where it's washed for another 48 hours in warm water with frequent stirring. The water is drawn off and renewed until the gun cotton passes the heat test which is now applied.

The pulp is now mixed with a little sodium carbonate. It is then drained and a measured quantity placed in the cylinder of a hydraulic press, through the perforated bottom of which most of the water is drawn off by a suction pump, and the press is then applied. It is pressed again in a more powerful press, and is thus obtained in the form of disks or cylinders of various sizes, having a density of 1.1 or 1.2, which are afterwards soaked in water until they contain about 25 per cent. of that liquid.

Granulated gun cotton is made by placing the pulp from the blender in a centrifugal machine, where its water is reduced to 33 per cent and the gun cotton is made fibrous, and then passing it through sieves, which break it into granules. It is then revolved for half an hour in a drum, mounted on a horizontal axis, for fifteen minutes, the drum revolving fast enough to cause the granules to roll rapidly down its surface, but not so fast as to carry the granules around with it.

You could also make them by taking a chunk of pressed dry gun cotton and roll it into a ball in your hands.

TESTING FOR QUALITY

The finished gun cotton is examined by the following tests:

1. The density must be over 1.
2. The moisture is determined by drying it at 60' C.
3. The combustion of 2 grams of gun cotton must leave a residue less than 0.08 grams in weight.
4. The gun cotton should dissolve entirely in ethyl acetate, which would leave unconverted cotton undissolved.
5. Fifty grains of the gun cotton should suffer little loss in weight when heated for two or three hours with four ounces of a mixture of 1 volume alcohol (40%) and 2 volumes distilled ether, which would dissolve any colloid cotton.
6. 4 grains are heated in a test tube placed in an oil bath, and containing a slip of paper moistened with a solution of potassium iodide and starch. No tinge should be imparted to the paper till the temperature of the oil reaches 88' C.
7. Four grains, heated as above, should give no visible brown tinge below 175' C.
8. One grain is heated in a test tube, placed in an oil bath, till it explodes, which should not happen below 179'

PROPERTIES

Gun cotton resembles cotton wool in appearance, but is harsher to the touch; it

becomes powerfully electric when rubbed, crackling and phosphorescing, and emitting sparks in the dark. It remains unaltered in contact with water, and can be worked and stored in the wet state without danger. On ignition it burns quietly when dry and leaves no residue; wet gun cotton is not combustible. Gun cotton is insoluble in alcohol and ether or a mixture of the two, but is dissolved by acetic ether and by a mixture of ordinary ether with ammonia. Strong sulphuric acid dissolves it without carbonization, strong potash lye will also dissolve it, especially if heated to 70' C. A solution of potassium sulphhydride reduces it to cellulose. When properly prepared it remains unaltered-it has been kept stored for 12 years without chance.

Dry gun cotton inflames by percussion, but is never exploded, even by the passage of a bullet fired at short range, unless confined. Its explosive effect is greatest when detonated by means of a primer of mercury fulminate, in which case no confinement is necessary. The rate of propagation of the detonation in a mass of dry compressed gun cotton is about 5,500 meters per second.

Wet gun cotton is not affected by percussion, and can be detonated only by the detonation of an amount of dry gun cotton bearing a certain ratio to the weight of wet gun cotton employed. Its explosive effect is much greater than that of dry gun cotton.

The temperature at which gun cotton explodes when heated is about 179' to 181' C., under the most favorable circumstances, but usually a much higher temperature is required. The temperature resulting from the explosion is about 4400' C. One gram of gun cotton, on explosion, gives a quantity of gaseous products calculated to occupy at 0' C. and 760 mm. Hg, 753 c.c., which, at the temperature of explosion, would be expanded to 12,889 c.c. The pressure produced by the detonation is estimated at 160 tons per square inch.

Cylinders about 3 inches long and 2.5 inches in diameter weigh 1 lb. Cylinders 30 mm. high and 25 mm. in diameter, with a central canal 5 mm. in diameter, weigh 25 grams dry.

USING GUN COTTON AS AN EXPLOSIVE

Dry gun cotton is much easier to detonate than wet gun cotton, but it's not as powerful. And trying to compress a large quantity of gun cotton to the required density is a pain. The solution the book presented was to take granulated gun cotton (large granules over 1 inch cubed), fill the container with the granules, and then fill the gaps with melted paraffin wax to consolidate it into a single mass. Then a primer of dried granules (about 20% by weight of wet granules) is placed into the container, gaps filled with wax, and it is this that is primed with the detonator.

An important detail about the granules is that they are taken damp from the tumbler that's granulated them and dipped in acetate to form a tough skin on the outside of the granules to keep them moist inside. Buying amyl acetate is an option,

but you can buy a product that is perfect for this called "Big D Lemon Room Deodorant", product #346. It's manufactured by Big D Industries, Inc, Oklahoma City, OK, 73148.

It's a mixture of ethyl and amyl acetate dissolved in isopropanol. Available from institutional suppliers.

Once you have your granules ready, put them on a tray and spray them till they're wetted with the lemon spray. Let it evaporate to dryness. Make sure you get all sides and ends.

Napalm Step By Step How To By Koslo **Napalm (Standard)**

Description: Simple, simple, simple... and better performing than most.

Materials: Undissolvable (gasoline won't dissolve them) containers (Glass pilot jars, pop cans, and 1-gallon paint cans are your best bet), ample amount of gasoline, and compressed-sphere styrofoam (little spherical bits tend to flake off when it's broken).

Procedure:

1. Take your gasoline and fill the (we'll assume) jars approximately 3/4 of the way full (space must be allowed for foam dissolving and expansion)
2. Take styrofoam and break into pieces that fit in the jar, and begin to insert them into the gasoline, giving them time to dissolve completely.
3. Feed styrofoam until the mix becomes a very slick gel and absolutely refuses to eat anymore.
4. (This is the part which makes it higher quality than others) Allow the mixture to sit for 3-5 days, away from water or rain.
5. After mixture has set (i.e. hard layer on top, possible visible seperation of water and gel), take a rod or stick and jab a hole through the hard layer on top. Then drain all the water that has formed on the bottom, and now you have a good napalm mixture, though you may want to mix it a bit more to get it loosened and gelled again.

Napalm (Improved/Ultra-Thick)

Description: Very thick and strong napalm mix

Materials: Same as Standard Napalm, except substitute styrofoam insulation (i.e. the pink, ultra-tough stuff) for regular styrofoam

Procedure: Same as Standard Napalm, except substitute styrofoam insulation (i.e. the pink, ultra-tough stuff) for regular styrofoam (I am uncertain if it needs a few days to set; mine set for a month)

N (Fun Variant)

Description: A fun variant, though not too useful.

Materials: Same as either Standard or Ultra Napalm, flour. Optional: Cinnamon, spices, etc.

Procedure: Same as either Standard or Ultra Napalm, except, while mixing, start adding a good quantity of flour and optional spices before it is too gelled. Mix for a while and add styrofoam or flour as needed until thick.

Blasting Caps

Kitchen Improvised Blasting Caps by Tim Lewis

Published by Information Publishing 1995.

HOW BLASTING CAPS WORK

I know you have seen before, on TV, the western where the good guy sticks a fuse in a stick of dynamite and presto he has a fuse detonation device? If you have used explosives in the military or otherwise you know that this is a bunch of hooey! While there are explosive compositions that can be made to detonate this easily, this same trait gives them a dangerous nature that requires very special precautions, if they can be used at all.

Detonation is in essence a chemical reaction brought about by a high velocity shock wave at speeds as low as 1100 M/sec. and going up to 9300 M/sec. for "Median" explosives. This shock wave is initially produced by the blasting cap and is continued throughout the explosive charge as the detonation progresses. These waves have the appearance, in high speed photos, similar to ripples in a smooth pond of water as a pebble is thrown in. These detonation waves must meet or exceed certain strength and rate requirements to detonate a particular charge or explosive. Each explosive has a different requirement for detonation from the blasting cap standpoint. A good rule of thumb for any explosive is to use more blasting cap than is needed. This is a good idea as most explosives can be overdriven with a larger than needed detonator. By overdriven, I mean that an abnormally high detonation rate can be achieved as the high speed detonation from the cap will carry over in the explosive. Many people with whom I have conversed, have mentioned pipe bombs that are made by filling a pipe with either black powder or smokeless powder. These pipe bombs are poor for fragmentation due to the actual deflagration nature of this type ordinance. Deflagration is the simple burning of a propellant or explosive. This will generate pressure great enough to rupture the container (pipe) and no more. 2" schedule 40 pipe will rupture at approximately 7144 PSI If black powder or smokeless powder is being used, this is the maximum pressure a pipe bomb would generate. If this same pipe were filled with powdered ammonium nitrate fuel oil explosive and detonated with a blasting cap with an approximate pressure of detonation of 600,000 PSI plus. This same set up (cap initiated) with "Bulls eye" brand smokeless powder from Hercules Inc. Wilmington Delaware as a pipe filler with a blasting cap will generate approximately 2,000,000 In plus detonation pressure. This amounts to an 8300% and 28000% increase over deflagration respectively. As these figures prove, true detonation is awesome and an unbelievable increase over simple propellant deflagration explosive fillers. Most of the high CHNO explosive groups will make the transition from deflagration to detonation. Usually this transition will require the build up of a good deal of pressure. The ammonium nitrate cargos of the High Flyer and Grandcamp are said to possibly have undergone this type of deflagration to detonation transition. This transitions, caused the detonation of their cargos of

thousands of tons of fertilizer grade ammonium nitrate. This detonation in Texas City, Texas Harbor, in 1947 generated 50 million dollars damage and jiggled seismograph needles in Denver, Colorado. This was the largest non nuclear explosion in U.S. history.

As mentioned earlier we have explained that detonation is a shock wave induced chemical reaction. This detonation wave, and what happens, is perhaps explained easier in the drawing below. In this drawing the zone in front of the shock wave is the unreacted zone. Behind this zone, the shock wave is seen. This area of the shock wave is called the "Shock zone." This is the mechanical shock wave that originated at the detonator. This shock zone is usually 0.00001 cm long. The "chemical reaction zone" immediately follows the shock zone. The shock zone is the point of the highest pressure of the detonation. The "chemical reaction zone" is the part of the detonation zone that has the highest temperature and velocity.

This chemical reaction zone is where the actual chemical reactions of the detonation, and the subsequent detonation byproducts are produced. This zone does not actually include the detonation byproducts because the reactions are not complete. This chemical reaction zone is usually 0.1 to 1.0 cm long. One of the characteristic differences of deflagration and detonation is the flow of the byproducts. In deflagration the products flow from the combustion zone. In detonation the products flow toward the shock zone.

At times the detonation zone in an explosive can progress through the explosive at a much slower than normal rate. This is called low order detonation. Nitroglycerin, one of the most powerful explosives known, still has this undesirable trait. "Nitro" can detonate with high order detonation rates of over 8000 M/sec. while low order detonation can be as low at 1500 M/sec..

The density of an explosive has a great bearing on the rate of the detonation zone than the explosive mass. Every explosive has a greater detonation velocity with respect to the density. These are fixed and unchangeable under ideal conditions. Usually, the greater the density, the higher the detonation rate. Also, the higher the density, the lower the sensitivity. These statements, of course, are generalizations and will not hold true always. In a classic sense they give somewhat of an idea as to the way explosives perform.

As this is a field of explosives that can become a lifelong study, we won't attempt to give course in these theories. It is good, however, to understand why explosives perform the way they do so that maximum use could be had from them. The theory above is the hydrodynamic theory of detonation. This is the most generally accepted of the explosive detonation theories. For further reading here are two good books:

DETONATION AND TWO PHASE FLOW

Vol. 6 of "Progress in Astronautics and Rocketry" by S.S. Penner & B.P. Mullins
Academic Press (NY NY)

SCIENCE OF HIGH EXPLOSIVES by M.A. Cook
from Information Publishing

Available

For the purpose of this book we will cover two different types of explosives. Primary and base explosives, with respect to blasting cap manufacture and the manufacture of these explosives. Primary explosives are usually sensitive to shock, friction, and heat. They are used to detonate the base charge in blasting caps. These explosives are used due to the ability of the primary explosive to make an easy and quick transition to detonation. As a general rule, these explosives require very little confinement to make the deflagration to detonation transition.

The detonation wave set up by the primary explosive is the beginning of the detonation process. This primary shock wave will detonate the base charge in the caps. The base charge of the cap is normally R.D.X. or some other high explosive. The base charge needs to be powerful and stable, but still sensitive to the primary detonation wave. The 6700 M/sec. plus base charge detonation velocity, will set off the main charge and with lower velocity explosive will overdrive them by sending such a high velocity shock wave through the explosive.

How Blasting Caps Function

Upon application of current, the bridge wire of the electric cap heats to incandescence and ignites the loose ignition mixture. The resulting heat or flame sets off the extremely sensitive intermediate charge which, in turn, detonates the base charge.

In nonelectrical caps the burning safety fuse ignites the ignition charge, which sets off the priming explosive, which in turn detonates the base charge. In both cases the sequence following initiation is essentially identical. When the primary explosive is stimulated by a sufficient amount of heat or flame, it undergoes a rapid chemical transformation from a solid into a hot gas by a process somewhat similar to the multiplication and amplification of the burning reaction which occurs within a low explosive. However, the speed of the reaction is so rapid

the
of

that
mass

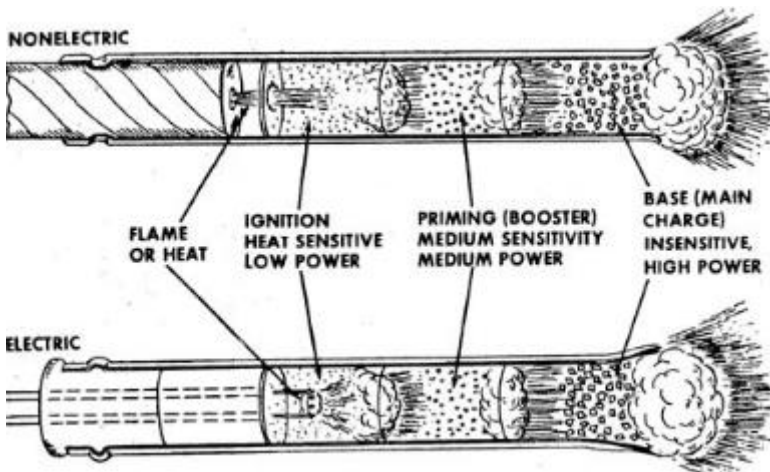

burning hot gas which it generates transcends ordinary burning and becomes a wave or expanding wall of pressure capable of initiating a larger volume of an adjacent high explosive by its shock velocity alone. This wave or shock front is called the blast propagation or propagation wave, This reaction is illustrated below.

The Blasting Cap Shell

Once a primary high explosive has been manufactured or obtained, it is ready for placement into a suitable container. A wide variety of containers may be employed, although a rigid walled container is usually selected in order to minimize accidental friction, shock, or stress to the sensitive primary high explosive compound. In addition to being rigid, if the container is metal a chemically nonreactive or low reactivity metal such as copper or aluminum is usually selected. Lengths of 1/4 inch diameter or larger copper or aluminum tubing, obtained from hardware or automotive supply houses are frequently employed as improvised blasting cap shells. These soft metal tubes are first cut to the desired length, usually about two to three inches, and then sealed at one end by soldering or cementing the materials.

Improvised blasting cap shell construction is certainly not limited to copper and aluminum tubing. Lengths of automobile radio antenna (chrome-plated brass); plastic bodies of ball point, felt tip, and fountain pens; thin-walled brass tubing used by model makers; plastic soda straws; glass test tubes; and many other materials have been successfully employed as improvised blasting cap shells with excellent results.

Various types of improvised nonelectric blasting caps are illustrated below.

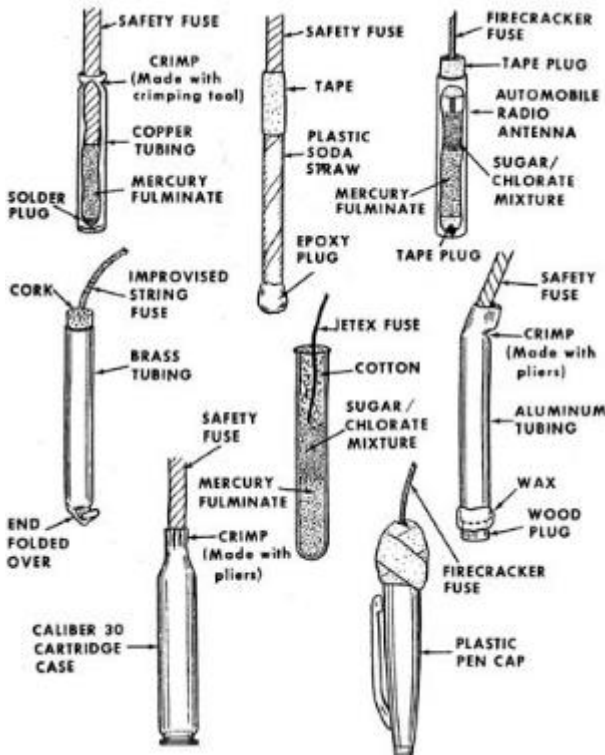

Once the shell has been plugged at one end, the primary high explosive crystals are carefully placed into the shell and lightly packed or tamped with a rod. This procedure is not overly hazardous so long as a wooden rod is employed to press the explosive into the tube. Loose crystals of mercury fulminate have an apparent density (gravimetric density) of about 1.75.

When employed in commercially manufactured blasting caps, mercury fulminate is compressed to densities of approximately 2.5 to 4.0 under a pressure of about 3,000 pounds per square

inch. This density will produce a detonation velocity of about 4,000 meters per second. Mercury fulminate is not more sensitive to heat, flame, spark, or shock after compression than in loose crystal condition, but the increased density produces a higher detonation velocity which increases its efficiency.

Generally no real attempt at density increase is attempted by the manufacturer of improvised blasting caps. The crystals are simply tightly packed into the shell container. So long as the manufacturer contents himself with tamping or compressing the crystals of mercury fulminate with a wooden rod or dowel no real danger exists, and space will be conserved within the shell.

The improvised blasting cap will probably be loaded with one to four grams of mercury fulminate crystals. Normally, loading the shell with one gram would produce an improvised blasting cap approximately Number 6 strength if the manufacturer was able to achieve the proper density of explosive in loading. In most cases the desired density pressure of 3,000 pounds per square inch cannot be achieved and the builder compensates usually by increasing the total amount of explosive loaded.

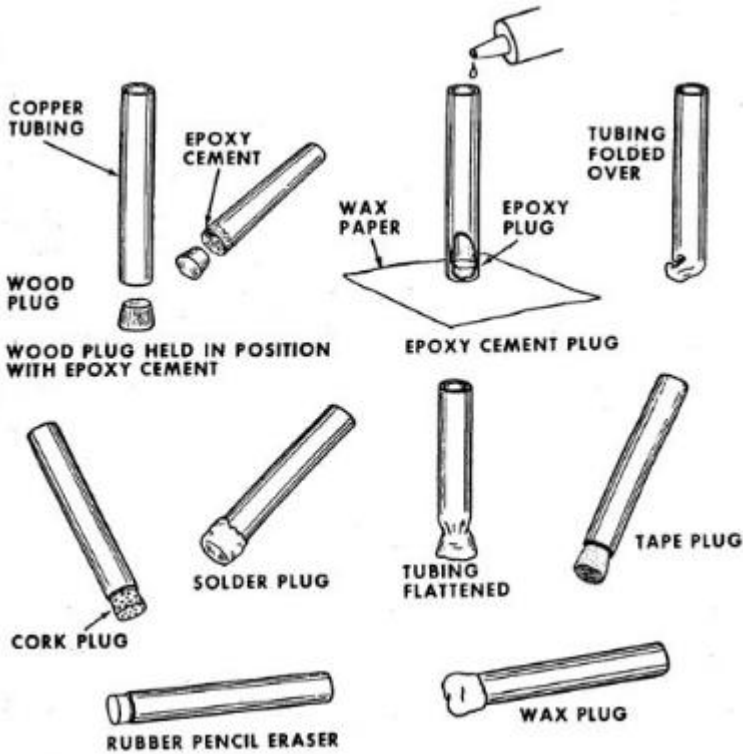

Once the shell has been loaded with the explosive, it is a simple matter to insert a length of commercial safety fuse into the copper or aluminum tube until it makes contact with the tamped crystals. Once in place, the soft tubing may be crimped lightly around the fuse with a pair of pliers, or the two units may be taped together. In instances where the shell of the improvised blasting cap is made of plastic or glass, tape or cement will be employed to join the safety fuse to the cap shell.

If commercial safety fuse cannot be obtained for use with the improvised nonelectric blasting cap, either firecracker fuse, model rocket fuse such as "Jetex," or improvised fuse will be used. Because these fuses are normally small in diameter (1/8 to 1/32 inch) and do not produce the desired intense hot spit of flame required for reliable initiation of the improvised nonelectric blasting cap, the builder will usually load a portion of the blasting cap shell with a burning or ignition compound such as potassium chlorate and granular sugar to insure ignition and detonation. These smaller diameter fuses are generally affixed with tape to the improvised blasting cap shell, if the fuse employed is of the external burning type and excessive taping of the fuse occurs, there is an excellent chance that the name will be extinguished by contact with the tape and a misfire will occur.

In some cases, improvised nonelectric blasting caps used in conjunction with commercial safety fuses have been made highly waterproof by the application of silicon rubber cement (sealing compound) to the joint area between the safety fuse and the cap shell. Other improvised nonelectric blasting caps joined to commercial safety fuses have been encased inside long balloons or condoms to provide a degree of water or moisture resistance.

Typical Improved Electric Caps

The same basic construction, configuration, and explosive loading of the improvised blasting cap shell applies to both nonelectric and electric blasting caps. The essential difference is in the method employed in the ignition of the primary high explosive filler. Improved electric blasting cap construction can utilize one of three basic systems for obtaining electrical ignition:

- Small Flashlight Bulb Method
- Automobile Light Bulb Method
- Improved Bridge Wire Methods

Small Flashlight Bulb Method

The most commonly employed system of electrical ignition uses the fine filament wire inside a small flashlight bulb as the electrical ignition or bridge wire element. A bulb having a protruding glass tip, such as the PR #2 type, is normally preferred. Wires are soldered to the bulb contact points and then the tip of the glass bulb is carefully broken off with a pair of pliers. Black powder, smokeless powder, or a mixture of potassium chlorate and granular sugar is carefully placed into the glass bulb around the filament wire and into the open end of the improvised blasting cap shell. After the hole in the bulb is aligned with the open end of the shell, the bulb and cap shell are joined together with tape, as illustrated below. This system has also been employed to convert commercially manufactured nonelectric blasting caps to improved electric blasting caps. Conversion by this system has received wide usage for a number of years by terrorists in the Middle East, Latin America, and other parts of the world.

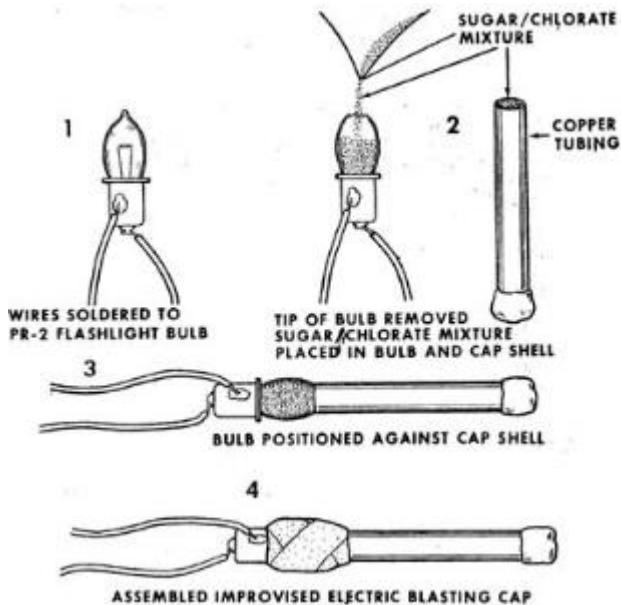

The reliability of this conversion or ignition system is high. Failures occur only when the filament wire in the bulb is broken, when the violent burning action prematurely separates the bulb and the cap shell, or when damp ignition materials are employed inside the flashlight bulb and fail to ignite before the bulb filament wire burns in half. When care is taken in assembling the component parts, the rate of failure is extremely low.

This system of ignition or conversion is widely known among bombers in this country. The Department of the Army Technical Manual TM 31-200-1, "Unconventional Warfare Devices and Techniques, References", provides an illustrated example of this construction technique. While this 1966 publication was reclassified to "confidential" by the Army in 1970, no attempt was made to recover copies from public libraries, schools, or private citizens. In effect, therefore, the reclassification applied only to the military. Copies of this now "classified" manual are presently being offered for sale by a number of publishing houses in the United States, apparently without fear of legal action for federal security violations.

Automobile Light Bulb Method.

The second system of conversion or assembly of improvised electric blasting caps is also illustrated and explained in Army Technical Manual TM 31-200-1, and, therefore, must be considered to be available to potential bombers.

This method involves the employment of an automobile light bulb normally used in parking or dome lights. These bulbs have a metal base approximately 1/2 inch in diameter and a large and fairly heavy bulb filament wire. Wires are soldered to

the outside of the metal light bulb. The glass bulb is broken away by slowly squeezing it between the jaws of a vice or a pipe wrench, taking care not to break the bulb filament wire. The open end of the improvised blasting cap shell is then filled with smokeless powder or some other highly flammable substance, and the light bulb filament wire is carefully imbedded in the mixture. Once the bulb filament wire has been imbedded, the bulb body is cemented or taped to the improvised blasting cap shell to complete the assembly.

The degree of reliability of this ignition system is directly proportional to the manual skill level of the builder. If the builder is a careful craftsman, he will probably be able to assemble this improvised electric blasting cap without causing the bulb filament to break. In normal employment, the probable failure rate of improvised electric blasting caps assembled by using this technique will probably run from ten to fifty percent. Removing the bulb filament wire from its protective glass envelope and inserting it into an ignition mixture frequently results in breakage of the filament wire and failure of the blasting cap.

If the builder has access to a blasting galvanometer, it is possible to check the continuity of the electrical circuit after the assembly of the improvised blasting cap to determine if the filament wire has been broken. In most cases, however, the builder does not possess a blasting galvanometer, nor can such a device be safely improvised. When it is not possible to determine if the filament wire is intact after assembly, this method is not particularly reliable.

Improved Bridge Wire Methods.

A third method of improvising electric caps involves the construction of bridge wire assemblies by employing one of three distinct techniques:

- Soldered bridge wire
- Multi-strand or single strand bridge wire
- Model rocket igniter bridge wire

However, regardless of which technique is used, it is necessary to support and protect the bridge wire in some manner during assembly and use in order to prevent breakage or electrical shorting of the bridge wire unit. When such protection and support can be provided by wooden plugs, electrical tape, epoxy cement, silicon rubber sealant, wax, cardboard or many other materials, probably the most professional support units are constructed from the erasers found on ordinary wooden pencils. Rubber pencil erasers measure approximately 1/4 inch in diameter by 1/2 inch in length and their size and shape make them ideal bridge wire support units that will fit snugly into copper automobile gas line tubing, fired .30 caliber cartridge cases, sections of radio antenna and other shell materials normally employed in the construction of improvised blasting caps.

If the improvised blasting cap shell opening is larger than the pencil eraser, it is a simple matter to wrap the eraser with tape and increase the diameter until a correct fit is obtained. The rubber pencil eraser is prepared for use by employing a

razor blade to cut two "V" grooves on opposite sides of the eraser. The electrical wire used in construction of the improvised bridge wire is then pressed tightly into these grooves until flush with the outside surface of the eraser. The rubber eraser body will grip and hold the wires tightly in position as well as provide electrical insulation if bare or uninsulated wires are used.

Soldered Bridge Wire Technique.

The electrical wires protruding beyond the end of the eraser bridge wire support unit are allowed to extend 1/8 to 1/4 inch in length and are stripped of electrical insulation. These strands of copper wire are generally 18 to 22 gauge in diameter. After the eraser bridge wire support unit with the two protruding wires inserted has been placed firmly in a small vise, a length of much finer nichrome or copper wire is carefully soldered to the protruding wire ends to form the bridge wire unit. When the excess wire is trimmed away, the improvised bridge wire unit is complete and ready for insertion into the ignition material previously placed waterproofing into the blasting cap shell. The illustration below illustrates this technique of bridge wire construction. If of the improvised electric blasting cap is required, the end may be wax coated or painted with rubber cement.

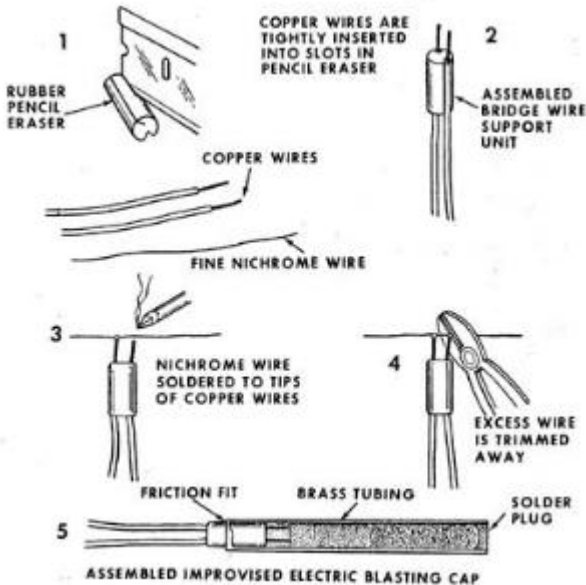

Multi-Strand/Single Strand Bridge Wire Technique

The construction of this bridge wire unit can be very simple if a small gauge multi-strand copper wire is utilized. The desired length of wire is selected and a 1/8 to 1/4 inch section of the electrical insulating material is carefully removed from the center section of the wire. The exposed multi-strand wire is then carefully cut one

strand at a time, until only a single strand of wire connects the two insulated sections. The single strand section acts as the bridge wire and is assembled to the rubber pencil eraser support unit as previously described. The bridge wire unit is then inserted into the improvised blasting cap shell to complete the construction of the electrical blasting cap.

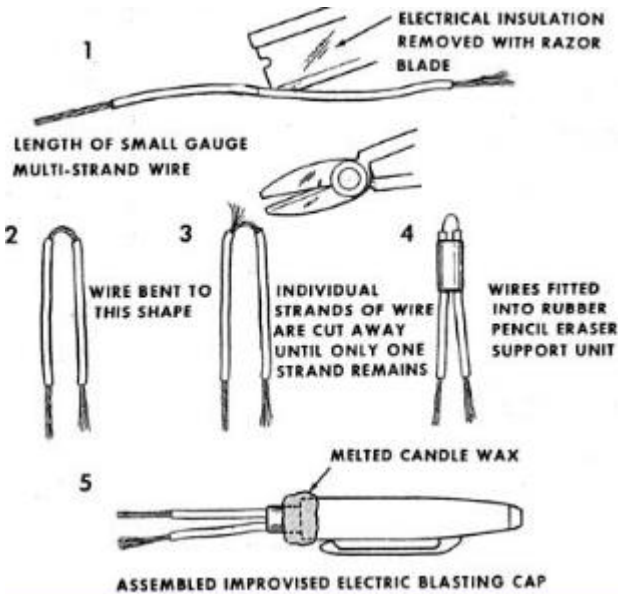

There are two primary disadvantages of this technique of construction. One is the fairly low resistance of the copper wire, as high resistance is desirable for heating. The second lies in the careful cutting away of the multi-strand wires to expose the single wire. The builders of these bridge wires frequently and unknowingly bend and break the single remaining strand of wire while assembling the wires to the support unit or inserting the unit into the cap shell. However, this system is still quite reliable and has been utilized by terrorists world-wide during the last twenty years.

Model Rocket Igniter Bridge Wire Technique.

Model rocketry is a growing hobby in the United States. Many hobby stores stock the model bodies, rocket motors, and accessories necessary to launch these rockets. One of the accessories commonly employed is a rocket motor igniter, which consists of a 3-inch length of fine chrome wire with an ignition composition in the center. These igniters, with their preassembled ignition compound, offer still another extremely simple method of manufacturing improvised electric blasting caps.

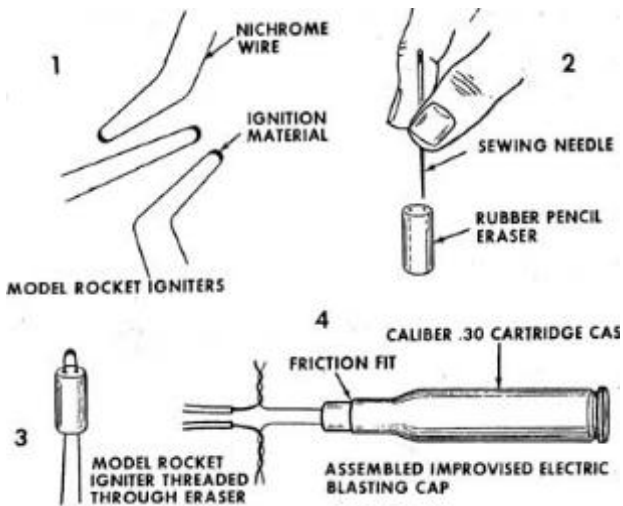

In constructing this bridge wire unit, the rubber pencil eraser is once again employed as a support unit. In this case, however, a sewing needle is used to push two holes longitudinally, 1/8 inch apart, through the eraser. The nichrome wire legs of the model rocket igniter are threaded through the holes and attached to longer lengths of wire by soldering or twisting. By placing the bare nichrome wires through the eraser, the builder insures that the wires will not be electrically short-circuited against the metal blasting cap shell and that the bridge wire is correctly positioned in the ignition mixture after insertion into the cap shell.

SIMPLE FUSE CAP MANUFACTURE

Being totally realistic one cannot hope to produce a blasting cap comparable to commercial products. The precision of modern manufacturing can produce caps cheaply and safely. The actual loading process is a dangerous one, but can be made relatively safe by taking the precautions outlined in the processes below. The home producer, can however, manufacture a cap that will work 99% of the time. These "homemade" caps will detonate most of the high explosives that their commercial counterparts will.

Fuse caps are blasting caps that are fired by the flame from a safety fuse. This flame ignites the flash charge of loose black powder. This, in turn, ignites the primary explosive. This primary explosive makes the transition from burning (deflagration) to detonation. These caps can be loaded as a simple cap or a compound cap. The simple cap has only the flash charge and the primary explosive. The compound caps have both these ingredients plus a high explosive base charge. The compound caps are usually a good deal stronger due to the high explosive base charge. To manufacture these caps the explosives are simply

pressed into the cap container. This container should be 1/4 inch in diameter (or larger) copper or aluminum tubing 1.25" long or a 5.56 mm NATO spent cartridge. The tubing can have one end sealed with a wooden plug or simply be crimped closed with a pair of pliers. The burr should be removed from the open end of the tubing. After removing this burr, these tubes would be ready to load with the explosive charges.

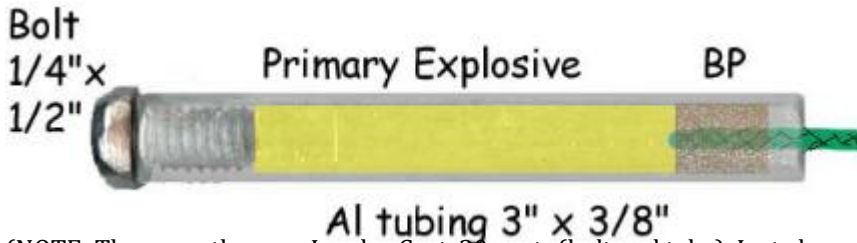

(NOTE: These are the caps I make. Cost: 30 cents (bolt and tube). Just clamp the tubing (gently) in a vise and screw in the bolt into the tube. Then grind down the bolt to round off the edges.)

When using a 5.56 mm NATO spent case the primer would need to be removed. After this has been done the flash hole would need to be enlarged enough to accept the fuse. This could be accomplished with a hand drill or by using a nail. The cap case would then be ready to insert the fuse and load with the explosive charges. The copper or aluminum tubes would need the base charge to be pressed in first. This pressing should be done with a close fitting wooden dowel. This should also be done with the tube supported rigidly from underneath and surrounded with bags of sand to absorb the explosion, if necessary. Find in this section a drawing of a loading apparatus. This apparatus would be safe as the operator would be remote. This press would be simple to make and would be highly recommended. Next the primary charge should be pressed into the tube.

CAUTION: Primary explosives are very sensitive to friction and impact ! Extreme care should be taken in this step of the procedure. A foul up here could be very dangerous!

After this primary charge is pressed a very small amount of black powder is placed on top of the primary charge. This will ensure the ignition of the primary charge. The fuse is then placed in the mouth of the filled tube so that the end contacts the black powder ignition charge.

NOTE: Use only good quality safety fuse. Good fuse can be made by soaking cotton twine in a saturated solution of potassium chlorate. This, however, will not be as reliable and therefore not as safe.

A small wad of cotton is then pressed on top of the fuse and igniter charge so that the fuse can exit the tube on one side. This is then crimped with pliers. Care should be taken to ensure the primary explosive is not present in the area of the tube to be crimped, as this crimping with this primary in between the tube walls could

very well cause the premature detonation of the cap. This cap would then be ready to use.

Simple caps can be loaded similarly with the deletion of the base charge in the loading. They can also be loaded into a .22 magnum spent cartridge case in a manner similar to the method above. These small caps will not be as powerful as the larger caps. Some of the primaries would not be suitable and all of the others would need their primary charge doubled for maximum performance.

The 5.56 mm cartridge case would be load is the exact opposite of the copper or aluminum tube caps. The fuse would be inserted into the case through the flash hole. The black powder ignition charge would then be place in the bottom of the case. The primary would then be placed in the bottom of the case. The primary would then be pressed into the case carefully and of course on top of that would be the base charge. After these were pressed into the case a small ball of cotton or paper would be pressed into the case to fill the remaining portion. Then the end of the case would be crimped with pliers to close the cap. This cap would then be ready to use.

1/4" aluminum or copper tube.

Igniter: Black Powder .20 G

PRIMARY:

HMTD .75 G

DDNP .50 G

Mercury Fulminate .75 G

Double Salts .75 G

Nitromannite .50 G

BASE:

RDX 1.0 G

PETN 1.0 G

Picric Acid 1.0 G

TeNN 1.0 G

Nitromannite 1.0 G

MMAN (3/8" tubing) 3.0 G

Nitroguanidine 2.0 G

Tetryl 1.5 G

As you can see by the above chart the nitromannite is listed as both a primary and

a base charge. The reason for this is, that while it is not actually a primary explosive, it tends to function as one. Nitromannite's use as a base charge makes use of the 8000+ M/sec. detonation velocity. This nitromannite is a very touchy substance with sensitivity approaching that of nitroglycerin. It would be best used as a last resort.

5.56 mm Empty cartridge case:

Igniter: Black powder .20 G

PRIMARY:

HMTD .75 G

DDNP .50 G

Mercury Fulminate .75 G

TACC 1.0 G

Double Salts .75 G

Lead Picrate 3.0 G

Nitromannite .50 G

TACN 4.5 G

BASE:

PETN 1.0 G

RDX 1.0 G

Picric Acid 1.0 G

TeNN 1.0 G

Nitromannite 1.0 G

Picric Acid 1.0 G

Nitroguanidine 2.0 G

MMAN (7.62case) 3.0 G

Tetryl 1.5 G

TACC is listed here as a primary. This is given due to the ease of manufacture. This primary is stated in literature to detonate TNT. The need for a heavy wall thickness detonator capsule would limit this to 5.56 mm shell detonators or larger empty shells. The use of MMAN would require waterproofing the finished cap by dipping in molten wax or paraffin.

ELECTRIC BLASTING CAP MANUFACTURE

Electric blasting caps offer a good deal more versatility to the blaster. This allows better and more remote blasting operations and the possibility for timed blasting applications are great but cannot offer the versatility of application. The electric blasting cap (EBC) can.

EBC's are very simple in their function. Current is passed through the two wires leading from the cap. This current, due to resistance, heats a small "bridge wire" which in turn fires an ignition mixture. This, in turn, fires the primary explosive and base charge respectively. The problem with improvisation is finding a performing bridge wire which will give reliable performance. Earlier literature has stated that the "guts" from light bulbs will work. They will work but cannot be expected to resist corrosion produced by some situations and could not be expected to give stable reliable detonation instigation.

Take a spent 7.62 mm NATO case. with a small pin punch, nail or other small slender rigid object, reach into the case and knock out the fired primer. Enlarge the flash hole with a 1/8 inch diameter drill. Deburr this enlarged hole so that the wires passing through will not have their insulation cut by these burrs, and thus causing a dud. Pass two sections of 22 gauge insulated wire, twelve inches long, through the 1/8 inch hole so that they go completely through the case, and their ends are free of the case mouth. Strip 1/8 inch of the insulation off the wires protruding from the case mouth. Cut a 3/8 inch section of .01 inch "nichrome wire", which is available at any hobby store or from nearly any electronics supplier. Nichrome wire is the wire inside toasters and other appliances that gets hot when current is passed through it. Discarded appliances could be another source of this wire. This piece of nichrome wire is spliced into both of the wires at the case mouth. Splice the 22 gauge wires to both ends of the nichrome wire bridge. This splice can be formed by twisting the nichrome wire around the upper part of the stripped 22 gauge wire and the lower part of the 22 gauge wire bent up to form a loop. A drop of solder is placed on these splices to ensure a good circuit. Outside dimensions of this improvised "bridge wire" should not be greater than .28 inches. A small wooden support should then be placed above the junction of the bridge wire. This will help the improvised bridge resist deformation and breaks from loading the cap. This wooden support could be made of a wooden match stick cut to length. This support should be 1/4 inch or less in length, with the ends notched out for the 22 gauge wire. These wires should be glued on the support stick. This whole bridge wire unit should be narrow enough to allow it to be pulled inside the 7.62 mm case even with the priming mixture on it. The wires should be twisted together on the other side of the wooden support after the glue on the ends of the support stick have dried, securing the wires in place. These bridge wire units are now ready to have their igniter composition placed on them. We will give three different compositions for this.

#1

Match heads (ground damp with acetone) 50%

Smokeless powder 50%

#2

Black powder (improvised will work) 50%

Smokeless powder 50%

#3

Potassium Perchlorate 60%

Sulfur 40%

White glue (Elmer's) enough to form a pasty mass

The first two of these compositions should be used by mixing and slightly dampened with acetone. This will form a putty type mixture. This is pressed very gently around the bridge wire assembly. Remember, you have to get this back into the case, and when dry this priming mixture will be as hard as rock. It should also be said that great care should be taken to ensure the continuity of the circuit. This can and should be checked by using a OHM meter. Let these dry, and they are almost ready to load with explosives. You may want to test one of these before loading to see how they work. In tests, these bridge wires when used in ignition squibs, were 98% reliable. They are also sensitive to 2 "C" batteries or larger.

Gently pull the bridge assembly into the case with the wires extended from the other side: When firmly in the case as far as possible, put several drops of "model airplane glue" in the recess where the spent primer was. This is allowed to dry. When dry, these are ready to load.

These are loaded with the same amounts of explosives as the fused caps so use the table in that section of this book to find the quantity to load. The only difference is the amount of black powder igniter used. Use 1/8 to 1/4 gram of black powder for the igniter charge. This is done to cushion the bridge wire when the primary and base explosives are pressed in. After the addition of the black powder igniter, tap the case to settle this charge. The primary explosive charge is very carefully pressed on top of the igniter charge with a wooden dowel and remotely if possible. Best results will be obtained with the press apparatus. See the drawing.

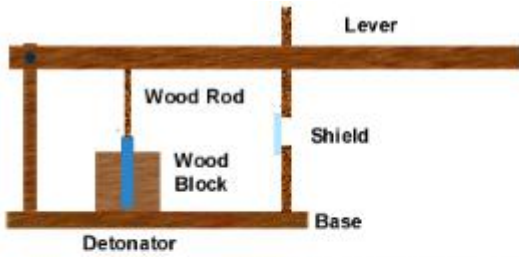

Using 2x4's and 1/2" plywood, you can build a press that will put 2 tons of pressure on the wood rod, compressing the primary explosive for maximum power. This is just an outline, anything that will do the same job is acceptable.

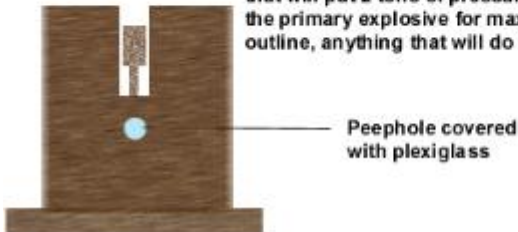

The base charge is then pressed on top of the primary charge. Check the circuits, one at a time, with a OHM meter from behind a barricade. Press cotton in the remaining part of the case, a crimp with cotton, in the part of the case that is being crimped. These can be water proofed by dipping the completed cap in hot wax for just long enough to immerse them completely. These caps are ready to use and will equal a #8 or #10 blasting cap.

Fuses and Ignition

A cigarette can be used as a ~8 minute fuse. An incense stick can last up to 30 minutes. For fuses of up to 99 hours however, you will need a digital time-delay system.

IGNITION DEVICES

There are many ways to ignite explosive devices. There is the classic "light the fuse, throw the bomb, and run" approach, and there are sensitive mercury switches, and many things in between. Generally, electrical detonation systems are safer than fuses, but there are times when fuses are more appropriate than electrical systems; it is difficult to carry an electrical detonation system into a stadium, for instance, without being caught. A device with a fuse or impact detonating fuse would be easier to hide.

FUSE IGNITION

The oldest form of explosive ignition, fuses are perhaps the favorite type of simple ignition system. By simply placing a piece of waterproof fuse in a device, one can have almost guaranteed ignition. Modern waterproof fuse is extremely reliable, burning at a rate of about 2.5 seconds to the inch. It is available as model rocketry fuse in most hobby shops, and costs about \$3.00 for a nine-foot length. Fuse is a popular ignition system for pipe bombers because of its simplicity. All that need be done is light it with a match or lighter. Of course, if the Army had fuses like this, then the grenade, which uses fuse ignition, would be very impracticable. If a grenade ignition system can be acquired, by all means, it is the most effective. But, since such things do not just float around, the next best thing is to prepare a fuse system which does not require the use of a match or lighter, but still retains its simplicity. One such method is described below:

MATERIALS

strike-on-cover type matches
electrical tape or duct tape
waterproof fuse

1) To determine the burn rate of a particular type of fuse, simply measure a 6 inch or longer piece of fuse and ignite it. With a stopwatch, press the start button the at the instant when the fuse lights, and stop the watch when the fuse reaches its end. Divide the time of burn by the length of fuse, and you have the burn rate of the fuse, in seconds per inch. This will be shown below:

Suppose an eight inch piece of fuse is burned, and its complete time of combustion is 20 seconds.

20 seconds

----- = 2.5 seconds per inch.

8 inches

If a delay of 10 seconds was desired with this fuse, divide the desired time by the number of seconds per inch:

10 seconds

----- = 4 inches

2.5 seconds / inch

NOTE: THE LENGTH OF FUSE HERE MEANS LENGTH OF FUSE TO THE POWDER. SOME FUSE, AT LEAST AN INCH, SHOULD BE INSIDE THE DEVICE. ALWAYS ADD THIS EXTRA INCH, AND PUT THIS EXTRA INCH AN INCH INTO THE DEVICE!!!

2) After deciding how long a delay is desired before the explosive device is to go off, add about 1/2 an inch to the premeasured amount of fuse, and cut it off.

3) Carefully remove the cardboard matches from the paper match case. Do not pull off individual matches; keep all the matches attached to the cardboard base. Take one of the cardboard match sections, and leave the other one to make a second igniter.

4) Wrap the matches around the end of the fuse, with the heads of the matches touching the very end of the fuse. Tape them there securely, making sure not to put tape over the match heads. Make sure they are very secure by pulling on them at the base of the assembly. They should not be able to move.

5) Wrap the cover of the matches around the matches attached to the fuse, making sure that the striker paper is below the match heads and the striker faces the match heads. Tape the paper so that is fairly tight around the matches. Do not tape the cover of the striker to the fuse or to the matches. Leave enough of the match book to pull on for ignition.

```

_____
\           /
\           / ----- match book cover
\           /
|   M|f|M ---|----- match head
|   A|u|A   |
|   T|s|T   |
|   C|e|C   |
|tapeH|.|Htape|
|       |f|       |
|#####|u|#####|----- striking paper
|#####|s|#####|
\   |e|   /
\   |.|   /
\   |f|   /
\   |u|   /
|ta|s|pe|
|ta|e|pe|
|. |
|f|
|u|
|s|
|e|
|. |
|_|

```

The match book is wrapped around the matches, and is taped to itself. The matches are taped to the fuse. The striker will rub against the matchheads when the match book is pulled.

6) When ready to use, simply pull on the match paper. It should pull the striking paper across the match heads with enough friction to light them. In turn, the burning matchheads will light the fuse, since it adjacent to the burning match heads.

IMPACT IGNITION

Impact ignition is an excellent method of ignition for spontaneous terrorist activities. The problem with an impact-detonating device is that it must be kept in a very safe container so that it will not explode while being transported to the place where it is to be used. This can be done by having a removable impact initiator.

The best and most reliable impact initiator is one that uses factory made initiators or primers. A no. 11 cap for black powder firearms is one such primer. They usually come in boxes of 100, and cost about \$2.50. To use such a cap, however, one needs a nipple that it will fit on. Black powder nipples are also available in gun stores. All that a person has to do is ask for a package of nipples and the caps that fit them. Nipples have a hole that goes all the way through them, and they have a threaded end, and an end to put the cap on.

When making using this type of initiator, a hole must be drilled into whatever container is used to make the bomb out of. The nipple is then screwed into the hole so that it fits tightly. Then, the cap can be carried and placed on the bomb when it is to be thrown. The cap should be bent a small amount before it is placed on the nipple, to make sure that it stays in place. The only other problem involved with an impact detonating bomb is that it must strike a hard surface on the nipple to set it off. By attaching fins or a small parachute on the end of the bomb opposite the primer, the bomb, when thrown, should strike the ground on the primer, and explode. Of course, a bomb with mercury fulminate in each end will go off on impact regardless of which end it strikes on, but mercury fulminate is also likely to go off if the person carrying the bomb is bumped hard.

ELECTRICAL IGNITION

Electrical ignition systems for detonation are usually the safest and most reliable form of ignition. Electrical systems are ideal for demolition work, if one doesn't have to worry so much about being caught. With two spools of 500 ft of wire and a car battery, one can detonate explosives from a "safe", comfortable distance, and be sure that there is nobody around that could get hurt. With an electrical system, one can control exactly what time a device will explode, within fractions of a second. Detonation can be aborted in less than a second's warning, if a person suddenly walks by the detonation sight, or if a police car chooses to roll by at the time. The two best electrical igniters are military squibs and model rocketry igniters. Blasting caps for construction also work well. Model rocketry igniters are sold in packages of six, and cost about \$1.00 per pack. All that need be done to use them is connect it to two wires and run a current through them.

Military squibs are difficult to get, but they are a little bit better, since they explode when a current is run through them, whereas rocketry igniters only burst into flame. Military squibs can be used to set off sensitive high explosives, such as R.D.X., or potassium chlorate mixed with petroleum jelly. Igniters can be used to set off black powder, mercury fulminate, or guncotton, which in turn, can set off a high order explosive.

ELECTRO-MECHANICAL IGNITION

Electro-mechanical ignition systems are systems that use some type of mechanical switch to set off an explosive charge electrically. This type of switch is typically used in booby traps or other devices in which the person who places the bomb does not wish to be anywhere near the device when it explodes. Several types of electro-mechanical detonators will be discussed.

Mercury Switches

Mercury switches are a switch that uses the fact that mercury metal conducts electricity, as do all metals, but mercury metal is a liquid at room temperatures. A typical mercury switch is a sealed glass tube with two electrodes and a bead of mercury metal. It is sealed because of mercury's nasty habit of giving off brain-damaging vapors. The diagram below may help to explain a mercury switch.

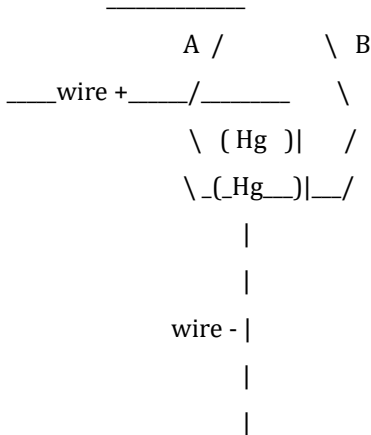

When the drop of mercury ("Hg" is mercury's atomic symbol) touches both contacts, current flows through the switch. If this particular switch was in its present position, A---B, current would be flowing, since the mercury can touch

both contacts in the horizontal position.

If, however, it was in the | position, the drop of mercury would only touch the + contact on the A side. Current, then couldn't flow, since mercury does not reach both contacts when the switch is in the vertical position. This type of switch is ideal to place by a door. If it were placed in the path of a swinging door in the vertical position, the motion of the door would knock the switch down, if it was held to the ground by a piece of tape. This would tilt the switch into the vertical position, causing the mercury to touch both contacts, allowing current to flow through the mercury, and to the igniter or squib in an explosive device. Imagine opening a door and having it slammed in your face by an explosion.

Tripwire Switches

A tripwire is an element of the classic booby trap. By placing a nearly invisible line of string or fishing line in the probable path of a victim, and by putting some type of trap there also, nasty things can be caused to occur. If this mode of thought is applied to explosives, how would one use such a tripwire to detonate a bomb. The technique is simple. By wrapping the tips of a standard clothespin with aluminum foil, and placing something between them, and connecting wires to each aluminum foil contact, an electric tripwire can be made, If a piece of wood attached to the tripwire was placed between the contacts on the clothespin, the clothespin would serve as a switch. When the tripwire was pulled, the clothespin would snap together, allowing current to flow between the two pieces of aluminum foil, thereby completing a circuit, which would have the igniter or squib in it. Current would flow between the contacts to the igniter or squib, heat the igniter or squib, causing it to explode.

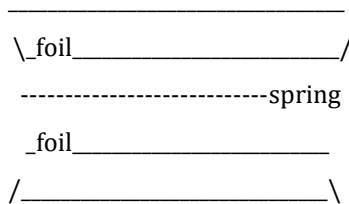

Insert strip of wood with trip-wire between foil contacts.

Make sure that the aluminum foil contacts do not touch the spring, since the spring also conducts electricity.

Radio Control Detonators

In the movies, every terrorist or criminal uses a radio controlled detonator to set off explosives. With a good radio detonator, one can be several miles away from the device, and still control exactly when it explodes, in much the same way as an electrical switch. The problem with radio detonators is that they

are rather costly. However, there could possibly be a reason that a terrorist would wish to spend the amounts of money involved with a RC (radio control) system and use it as a detonator. If such an individual wanted to devise an RC detonator, all he would need to do is visit the local hobby store or toy store, and buy a radio controlled toy. Taking it back to his/her abode, all that he/she would have to do is detach the solenoid/motor that controls the motion of the front wheels of a RC car, or detach the solenoid/motor of the elevators/rudder of a RC plane, or the rudder of a RC boat, and re-connect the squib or rocket engine igniter to the contacts for the solenoid/motor. The device should be tested several times with squibs or igniters, and fully charged batteries should be in both the controller and the receiver (the part that used to move parts before the device became a detonator).

DELAYS

A delay is a device which causes time to pass from when a device is set up to the time that it explodes. A regular fuse is a delay, but it would cost quite a bit to have a 24 hour delay with a fuse. This section deals with the different types of delays that can be employed by a terrorist who wishes to be sure that his bomb will go off, but wants to be out of the country when it does.

FUSE DELAYS

It is extremely simple to delay explosive devices that employ fuses for ignition. Perhaps the simplest way to do so is with a cigarette. An average cigarette burns for about 8 minutes. The higher the "tar" and nicotine rating, the slower the cigarette burns. Low "tar" and nicotine cigarettes burn quicker than the higher "tar" and nicotine cigarettes, but they are also less likely to go out if left unattended, i.e. not smoked. Depending on the wind or draft in a given place, a high "tar" cigarette is better for delaying the ignition of a fuse, but there must be enough wind or draft to give the cigarette enough oxygen to burn. People who use cigarettes for the purpose of delaying fuses will often test the cigarettes that they plan to use in advance to make sure they stay lit and to see how long it will burn. Once a cigarettes burn rate is determined, it is a simple matter of carefully putting a hole all the way through a cigarette with a toothpick at the point desired, and pushing the fuse for a device in the hole formed.

|=|

|=| ----- filter

paper is then gently twisted up so that it resembles a firecracker fuse, and is allowed to dry.

TIMER DELAYS

Timer delays, or "time bombs" are usually employed by an individual who wishes to threaten a place with a bomb and demand money to reveal its location and means to disarm it. Such a device could be placed in any populated place if it were concealed properly. There are several ways to build a timer delay. By simply using a screw as one contact at the time that detonation is desired, and using the hour hand of a clock as the other contact, a simple timer can be made. The minute hand of a clock should be removed, unless a delay of less than an hour is desired.

The main disadvantage with this type of timer is that it can only be set for a maximum time of 12 hours. If an electronic timer is used, such as that in an electronic clock, then delays of up to 24 hours are possible. By removing the speaker from an electronic clock, and attaching the wires of a squib or igniter to them, a timer with a delay of up to 24 hours can be made. All that one has to do is set the alarm time of the clock to the desired time, connect the leads, and go away. This could also be done with an electronic watch, if a larger battery were used, and the current to the speaker of the watch was stepped up via a transformer. This would be good, since such a timer could be extremely small.

The timer in a VCR (Video Cassette Recorder) would be ideal. VCR's can usually be set for times of up to a week. The leads from the timer to the recording equipment would be the ones that an igniter or squib would be connected to. Also, one can buy timers from electronics stores that would work well. Finally, one could employ a digital watch, and use a relay, or electro-magnetic switch to fire the igniter, and the current of the watch would not have to be stepped up.

CHEMICAL DELAYS

Chemical delays are uncommon, but they can be extremely effective in some cases. If a glass container is filled with concentrated sulfuric acid, and capped with several thicknesses of aluminum foil, or a cap that it will eat through, then it can be used as a delay. Sulfuric acid will react with aluminum foil to produce aluminum sulfate and hydrogen gas, and so the container must be open to the air on one end so that the pressure of the hydrogen gas that is forming does not break the container.

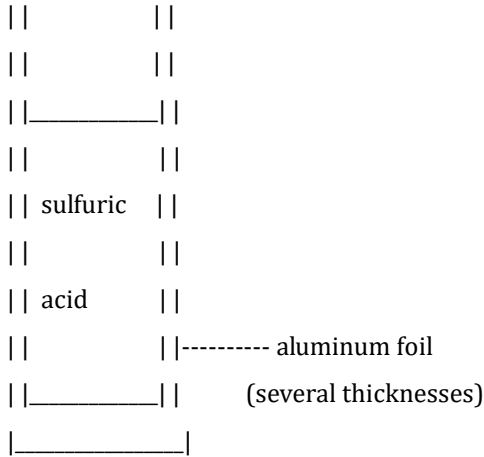

The aluminum foil is placed over the bottom of the container and secured there with tape. When the acid eats through the aluminum foil, it can be used to ignite an explosive device in several ways. 1)

Sulfuric acid is a good conductor of electricity. If the acid that eats through the foil is collected in a glass container placed underneath the foil, and two wires are placed in the glass container, a current will be able to flow through the acid when both of the wires are immersed in the acid.

2) Sulfuric acid reacts very violently with potassium chlorate. If the acid drips down into a container containing potassium chlorate, the potassium chlorate will burst into flame. This flame can be used to ignite a fuse, or the potassium chlorate can be the igniter for a thermite bomb, if some potassium chlorate is mixed in a 50/50 ratio with the thermite, and this mixture is used as an igniter for the rest of the thermite.

3) Sulfuric acid reacts with potassium permanganate in a similar way.

The illustration below shows how to make one. First you remove the back of the countdown timer. Next, cut the beeper from its leads and connect the wires from the relay and battery to these leads on the timer and the leads on the opposite side of the relay to the servoreceiver box. Mount the microswitch on the side of this box so the servoarm will be pressing down on the microswitch lever, thus keeping it depressed. Connect the wires from the microswitch to the electric door lock actuator on the barrel of the pistol or to another ignition system. Use the setup shown for connecting the electric door lock actuator to the pistol. The "workings" description in the illustration gives all the info needed for firing this system.

Spontaneous Combustion

Some of the ingredients for these can only be had from a chemical supply while others can be obtained with a little effort. out approx. 5 g of chromic anhydride. add 2 drops of ethyl

Scatter

alcohol. It will burst into flame immediately.

Measure by weight, four parts ammonium chloride, one part ammonium nitrate, four parts powdered zinc. Make sure that all the powders are very dry, and mix in a clean dry vessel. Pour out a small pile of this and make a depression on top. Put one or two drops of water in the depression. Stay well back from this.

Spoon out a small pile of powdered aluminum. Place a small amount of sodium peroxide on top of this. A volume the size of a small pea is about right. One drop of water will cause this to ignite in a blinding flare.

Measure by volume 3 parts concentrated sulfuric acid with 2 parts concentrated nitric acid. Mix the two acids in a large pyrex beaker. Hold a dropper of turpentine about 2 feet above the mixture. When drops strike the acid they will burst into flame.

Sulfuric acid reacts very violently with potassium chlorate and potassium permanganate. If a few drops of sulfuric acid are added to a pile of either of these oxidizers, the pile will burst into flame within seconds.

Most of the above mixtures can have other chemicals added to them (oxidizers, powdered metals) and can be placed on the top of a pile of a flammable substance, or used to start a fuse.

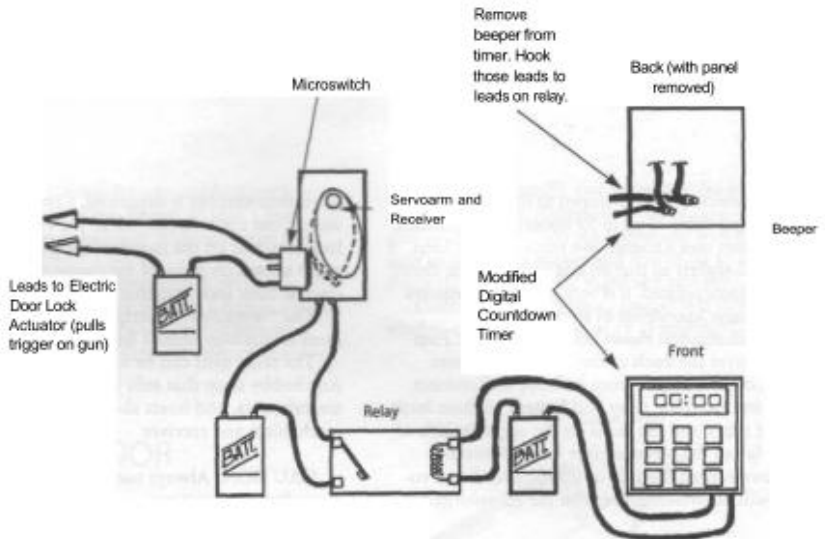

WORKINGS

1. Always test your circuits.
2. Timer counts down to zero, thus completing that circuit.
3. Relay opens.
4. Servo loses power and releases depressed microswitch.
5. Microswitch, which had been held in off position, is now open and on.
6. With microswitch on, the electric door lock actuator is activated and pulls trigger on gun.
7. Gun fires.
8. Most countdown timers have up to 99-hour and 99-minute delay.

Slow Burning Fuse (2 in. per minute approx.)

Materials needed:

- > cotton string or 3 shoelaces
- > potassium nitrate or potassium chlorate
- > granulated sugar

Procedure:

1. wash the cotton string or shoelaces in HOT soapy water, then rinse with fresh water.
2. mix the following together in a glass bowl:
 - 1 part potassium nitrate or potassium chlorate

- 1 part granulated sugar
- 2 parts hot water
3. Soak strings or shoelaces in this solution.
4. Twist/braid 3 strands together and allow them to dry.
5. Check burn rate to see how long it actually takes.

note: the few inches of this fuse to be inserted into the explosive device must be coated with a black-powder paste to ensure its reliability.

Fast Burning Fuse (40 in. per minute)

Materials needed:

- > soft cotton string
- > fine black powder
- > shallow dish or pan

Procedure:

1. moisten powder to form a paste
2. twist/braid 3 strands of cotton together
3. rub paste into string and allow to dry
4. check burn rate

Exploding bulb

Materials:

- > electric bulb
- > socket !
- > black powder
- > adhesive tape

Procedure:

1. drill a small hole in the top of the bulb near the threads
 2. carefully pour the black powder into the hole...enough so that it begins to touch the filament
 3. insert into socket as normal..
 4. get the hell out
- When they turn this sucker on, glass fragments fly like the devil...useful as an over-head fragmentation grenade.!

Napalm bulb

Materials:

- > electric bulb (100w)
- > 1/4 cup soap chips
- > 1/4 cup kerosene or gasoline
- > lighter or small blow torch
- > glue

Procedure:

note: make this in an open area. Nasty FUMES are given off.

1. heat kerosene/gasoline in a double boiler; melt soap chips, stirring slowly. Put somewhere and allow to cool.
2. heat the threads of the bulb VERY carefully to melt the glue. Remove threads, slowly drawing out the filament. DONT BREAK THE FILAMENT OR THIS WON'T WORK.
3. pour the liquid into the bulb, and slowly lower the filament back down into the bulb; make sure the filament is dipped into the fluid.
4. re-glue the threads back on; insert into a socket frequently used by the intended victim...

When the victim flips the switch, they're in for a BIG SURPRISE!

CHEAP ELECTRICAL IGNITERS

Materials:

- > pack of 100 silicon diodes!
(available at radio shack; you know you got the right ones if they are very, very small glass objects.)
- > pack of matches
- > 1 candle

Procedure:

1. light the candle and allow a large pool of molten wax to form in the top.
2. take a single match and hold the glass part of a single diode against the head...bend the wires around the head so that one wraps in an upward direction and then sticks out to the side...do the same with the other wire, but in a downward direction. The diode should now be hugging the match head, but its wires MUST NOT TOUCH EACH OTHER!!!!
3. dip the match head in wax to give it a water-proof coat (these work under water)
4. repeat steps 1 - 3 to make as many as you want

How to use:

When these little dudes are hooked across a 6vDC battery, the diode reaches what is called break-down voltage. When most electrical components reach

this voltage, they usually produce great amounts of heat and light, while quickly melting into a little blob. This heat is enough to ignite a match head. These are recommended for use under water, where most other igniters refuse to work.

Timer using a clock

The following simple timed bomb ignition system is designed for explosives which are concealed. Consider adding a booby trap (be creative) in order to complicate and slow down the defusing process should it be discovered.



1

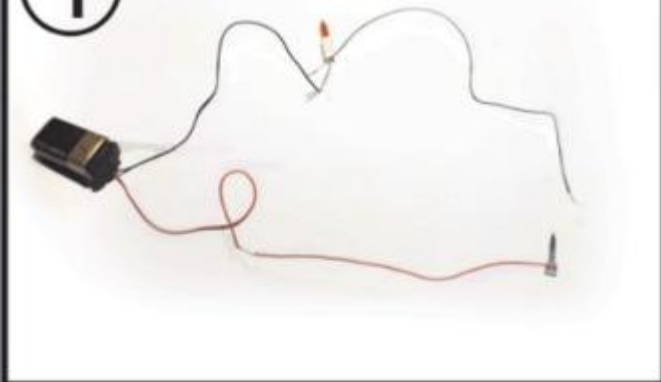

2

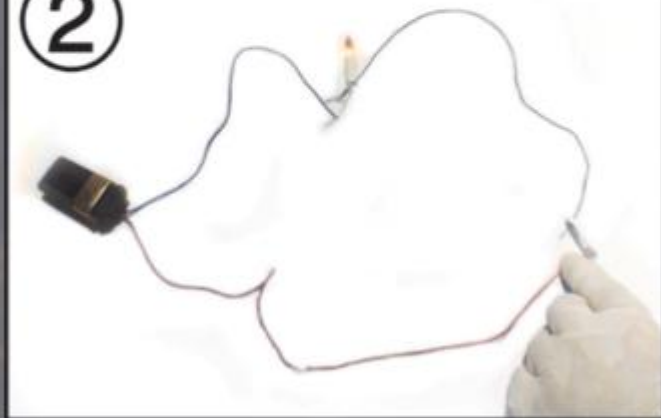

We have chosen for you the timed circuit as it is simple. We set up a circuit which is composed of:

- A 9V battery.
- A wire connected to the "+" of the battery and a nail (the red wire)
- A wire connected to the "-" of the battery and a test lamp (the black wire). Note: you may use any small lamp here. Take notice that this is not the lamp we filled before with the inflammable substance.
- We connect from the other pole of the lamp a green wire. When this wire touches the nail the circuit is closed and the lamp should light.

Note: the colors of the wires here are for demonstration purposes.

Setting the Clock:

1. Connect the green wire which is connected to the lamp to one of the clock arms.
2. Insert the nail into the clock face. This way when the arm of the clock moves it will touch the nail and the lamp would light.

Steps for setting up the clock:



1. Disassemble the clock.
2. If you want to set up the explosion to occur within an hour, cut off the arms of the clock except for the minutes arm. If you want more than an hour, you cut off all arms except for the hour arm.
3. Make a hole in the face of the clock to insert the nail.
4. Insert the nail through the hole and connect the green wire to the hour arm. Make another hole if necessary for the green wire.

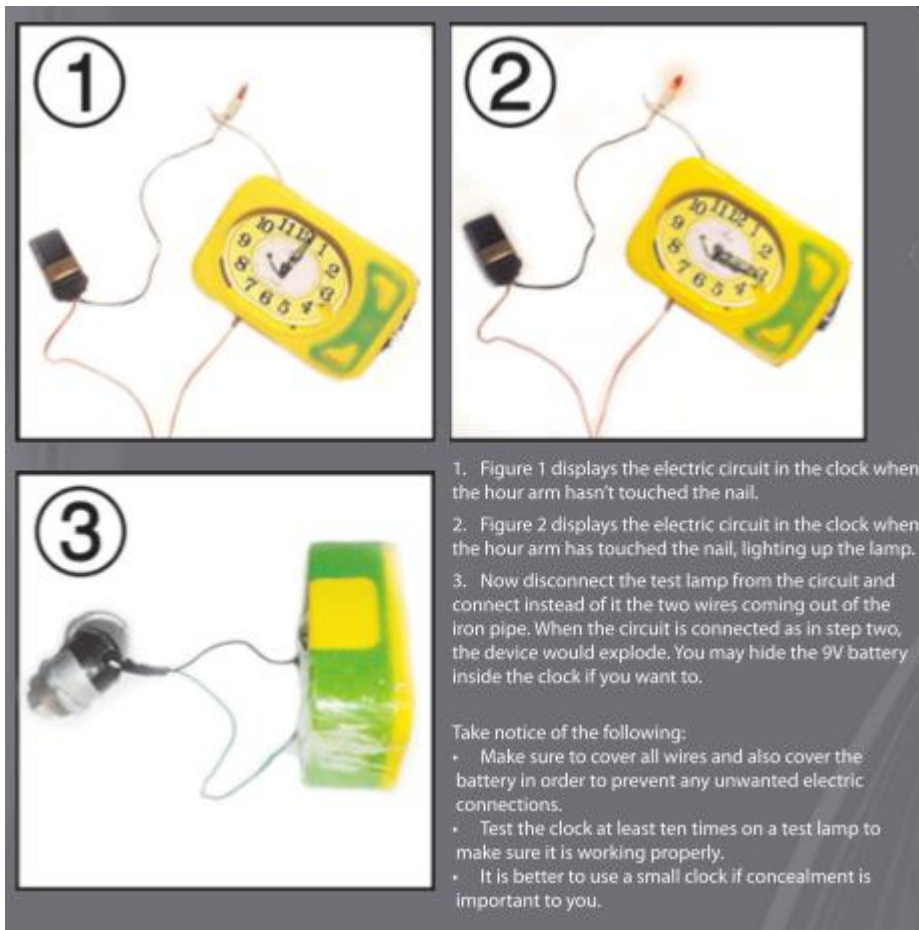

Remote Control Detonation system

There are two reliable and simple approaches to a remote controlled detonation system: using an remotely activated alarm, and using a communications device such as a phone. The advantage of a phone or radio receiver is that it may be dialled from great distances, but the circuitry is far more complex and there is the low possibility that a telemarketer or radio enthusiast detonates your device prematurely.



Remote Control Detonation

SKILL LEVEL: AVERAGE

REQUIRED COMPONENTS

The following comes in the box:

- remote
- receiver
- alarm speaker's wire

The following is separate:

- one or more 9V batteries
- 9V battery connector w/wires
- lamp light
- pliers
- screwdriver
- washing machine timer
- duct tape
- digital multimeter

REMEMBER



It is important to remember that we are using an alarm device for a motorcycle. If you use a car's alarm, you may or may not be able to follow our directions precisely depending on what you buy. The benefit in using the motorcycle alarm is that it is cheaper in contrast to the car alarm which is more expensive but has a greater range.

Detonating your explosive device can be done using many methods. In the first issue of *Inspire*, the AQ Chef discussed detonation by way of a clock. That is, you set the time on a clock, which is wired up to the bomb. When the time you chose is hit by the hour hand, the bomb detonates. This is ideal if you are trying to get as far away as possible from the scene. Its downside is that it is completely oblivious to the situation on the ground that may require an immediate or delayed detonation. The evident solution to that is to make the human being in control of the timing. In this section, we will explore how to make your own remote detonation device.

For the experiment, we purchased a motorcycle alarm set that is in the price range of fifteen to thirty dollars.

What you will need for this experiment is the remote, the receiver, alarm speaker's wire, one 9V battery or more depending on your need, a 9V battery connector, a small lamp light, pliers, screwdriver, washing machine timer, duct tape and a digital multimeter. The use of the washing machine timer is recommended. Its main purpose is to provide safety on the receiver. We will be discussing this in later steps.

Preparation:

1. Take the alarm speaker and clip the wires off of it. Then do the same for the receiver wires that connect to the alarm speaker as seen in Figure 1.2 on the following page. This will leave you with the two wires. Strip the coating of the wires ends using the pliers. Keep them aside for now.

FIGURE 1.0

Displayed are some of the essential components of this experiment.

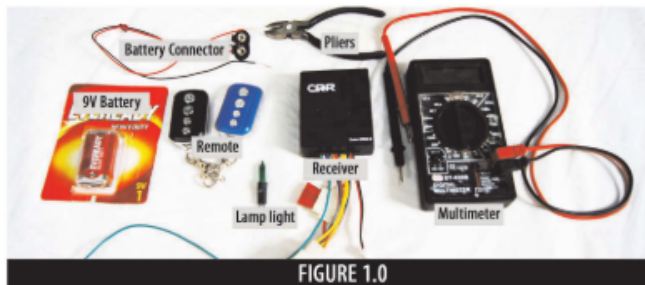
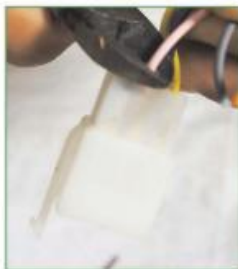

FIGURE 1.0

A LITTLE SCIENCE



The two yellow wires should be the wires for the amp connection. If this is not the case for you, then after cutting the wires from the plastic connection as in Step 2, you strip the coating off of them and test out which one of them has a voltage (through the use of the multimeter). When you find those two wires, you will use them to connect to the lamp.

IMPORTANT



Throughout the remainder of the instructions, the **positive (+)** is in reference to the **red wire** whereas the **negative (-)** is in reference to the **black wire**.

FYI

FIGURE 1.7



In the manuals of three remote control sets that we possess, we always found that the two wires with the same color are the ones we needed and according to the manuals, these were to be connected to the right and left signals of the car or motorcycle.



FIGURE 1.1



FIGURE 1.2



FIGURE 1.3



FIGURE 1.4



FIGURE 1.5



FIGURE 1.6

2. Cut all the wires from the plastic connections that are attached as seen in Figure 1.4.

3. Figure 1.5 shows the **red wire** going through the plastic connection; this is the **positive (+)**. Inside the plastic connection is a fuse that we won't be using, so proceed with cutting it out as seen in Figure 1.6.

4. Figure 1.7 below displays two yellow wires. If they are not yellow in your set, then know that the two wires with the same color are usually the ones you need. Obviously you would need to test to verify that this is the case because different makers of remote controls could have different specs.



SHOPPING TIP



When you purchase a battery connector, it should come with a short wire of **positive (+)** and **negative (-)**. Buying an extension for it might help in tidying up the final

A LITTLE SCIENCE



As seen above, in the first image there is a problem in the wire so the multimeter displays a number. If it is fine like in the second image, the displayed number will change.



FIGURE 1.8



FIGURE 1.9



FIGURE 2.0



FIGURE 2.1

5. After confirming which wires are needed, cut off the rest as seen in Figure 1.8. Make sure to leave the antenna intact since it is the wireless signal to your remote. The antenna in this remote is the green wire. In other remotes it could be a rod instead of a wire.

6. Wrap duct tape around the tips of the wires.

7. Remove the coating from the wires and twist them as seen in Figure 2.0.

8. Cut the 9V battery connection as shown in Figure 2.1.

9. We will now incorporate the battery connector into our steps and connect it with the receiver. Do that by wrapping the **positive (+)** of the battery connect to the **positive (+)** of the receiver. Then wrap the **negative (-)** of the battery connector to the **negative (-)** of the receiver as seen in Figures 2.2 and 2.3.



FIGURE 2.2



FIGURE 2.3



FIGURE 2.4



FIGURE 2.5



FIGURE 2.6

A LITTLE SCIENCE



The benefit of using both yellow wires is two-fold. Firstly, it will give the circuit more voltage. Secondly, if one of the wires is defective, the other would suffice.

REMEMBER



We have used a lamp here for testing purposes. After testing it, the detonator takes its place.



FIGURE 2.7

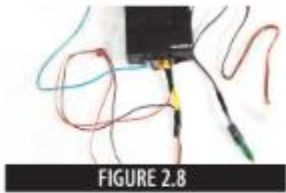

FIGURE 2.8

10. As shown in Figure 2.4 for the plastic connection that we had previously cut from the receiver, wrap one of the wires (it doesn't matter which one) of it to the negative (-) of the battery connector and the negative (-) of the receiver. That way, the negative (-) coming from the plastic connection is connected to both the battery connector and receiver as seen in Figure 2.5. Then with the other wire from the plastic connection, wrap it with either one of the yellow wires as shown in Figure 2.6 or with both.

11. Wrap the wires from the alarm speaker that we had earlier cut off with the lamp light as seen in Figure 2.7.

12. Figure 2.8 shows duct tape wrapped on all the exposed wires.

13. Connect the male plastic connection from the receiver to the female plastic connection from the lamp light as shown in Figure 2.9 below.

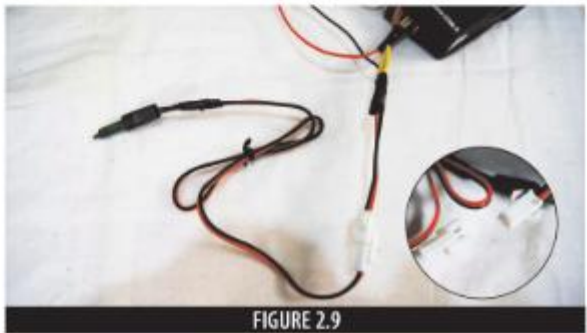

FIGURE 2.9

HINT



To use more than three batteries, purchase a few more battery connectors. The wires will be going in the same place as before (i.e., **positive (+)** with **positive (+)** and vice versa. The purpose of increasing the voltage is because if the detonator requires more amps, the extra batteries would facilitate that. A military detonator requires more amps (approx. 0.5amp) than a homemade one.

SHOPPING TIP



The model shown above has an antenna on the remote and receiver. The antenna strengthens the range giving it approximately 150 meters in the open.

A LITTLE SCIENCE



The multimeter or voltmeter helps in discovering any defects in the circuit. Hook it up in replacement of the lamplight to test the circuit. You need to place the dial as shown in the zoomed image above, if you want to test the batteries, then move the dial to 20 DCV.

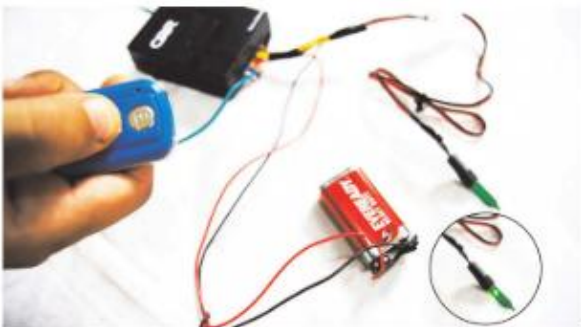

FIGURE 3.0



FIGURE 3.1

14. Connect the battery connector to the 9V battery. Press the unlock button on the remote for testing. If the connection is right, the lamp will light as shown in Figure 3.0.

15. To increase the voltage, increase the number of batteries. Figure 3.1 shows how to use three batteries. Use duct tape to ensure the stability of the batteries. When testing, notice the difference in the light between Figures 3.0 and 3.1. This ends the general assembly of the remote control detonation. It is now ready for use but there are further steps to take for the purposes of safety and ease.

Removing extra buttons:

To prevent accidental pressing of the buttons thus causing an unwanted detonation, then follow the images shown below. Unscrew the remote, remove all buttons except the unlocking one, and do the same for the buttons on the circuit board.



FIGURE 3.2

A LITTLE SCIENCE



The safety that the washing machine timer provides is only when the remote in your hand is the cause of detonation. The timer acts as a safety since it is what makes and breaks the circuit. When the metal rod is turned on the timer and hits the nail – which has a wire going to the receiver – it will not detonate until you press the unlock button on the remote. The timer is one of the ways in which a safety mechanism could be added to this remote control assembly. It provides safety while assembling the IED and dissembling it.

HINT

If you want the timer to act as the cause of detonation and not the remote, then you will remove the receiver and the two wires coming out from the timer which were going to the receiver and place it towards the detonator instead. That way, when the metal rod on the timer is turned and hits the nail, it will immediately explode. When assembling the IED, connect the detonator to the two wires that were going to the receiver and then turn the knob to the end, connect the battery and immediately leave.

IMPORTANT



Bombs can explode accidentally when there is no timer involved. Friction can be enough to detonate the device.



FIGURE 3.3



FIGURE 3.4

Using a washing machine timer:

A washing machine timer is used for safety on the receiver; it is what keeps the circuit connected and disconnected. It can also take the place of the remote and act as a timer for detonation. The timers shown in Figure 3.3 give a five-minute delay.

Preparation:

1. Screw a nail into the timer as shown in Figure 3.4.
2. The yellow wire that is going from the battery connector to the receiver is cut in the middle. One end of the wire is connected to the screw and the other is connected the metal rod protruding from the knob. The timer in this configuration serves as a terminator of the circuit. Refer to Figure 3.5 below.
3. Connect the wires as shown in Figure 3.5 (white is negative (-) and yellow is positive (+)). Notice that the cut must be in the positive (+). That is because the negative (-) charge could be delivered by a multitude of objects – such as friction – and this could cause accidental detonation. Therefore it should be wrapped with duct tape.

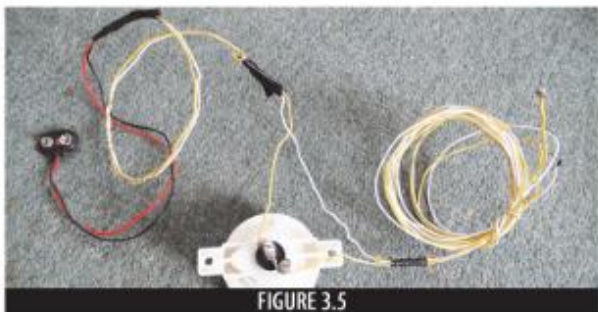

FIGURE 3.5

HINT



If you are assembling the bomb far away from the target, hook a small wire in the timer and around the metal rod to stop it from turning. When you reach the target, simply remove the wire and the timer will continue ticking.

DR. KHATEER'S ADVICE

- Follow the instructions carefully in the explosives field. The first mistake can be the last.
- In case the lamp doesn't turn on or you do not get a reading on the multimeter, then keep the wires that are connected to the negative (-) of the battery connector and the negative (-) of the receiver as they are and then test every other wire on the receiver by connecting it to the other end of the lamp or the multimeter.
- If the connections are right, the multimeter should show a reading of the voltage when pressing the unlock button on the remote control. It also depends on the battery you are using; so if you are using a 9V battery the reading should be close to 9V.



- For safety precautions, do not hook up your detonator with an analog multimeter or voltmeter. Because the current goes out of non-digital types, it will explode the detonator as we've tested. If, however, you hook up a digital multimeter with the detonator, it will be safe.
- Some remote sets come with two remotes; destroy one of them for safety precautions since it's possible that someone might press the button accidentally, causing a detonation.
- If you are concealing the bomb, make sure to have part of the receiver's antenna sticking out.
- Finally, the safest thing to do is to connect the battery just before placing the bomb in the place of target.

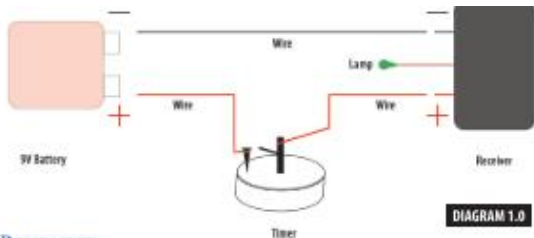

REMEMBER



In Diagram 1.0 above, the **positive (+)** of the battery is connected to the screw while the **positive (+)** of the receiver is connected to the metal rod. The **negative (-)** of the battery is connected directly to the **negative (-)** of the receiver.

Steps for using the timer with an Improvised Explosive Device (IED):

When placing the timer with the IED at the place of destination:

- a. Connect the detonator to the receiver (in place of the lamp).
- b. Turn the knob on the timer to the time needed.
- c. Connect the battery.
- d. Place the detonator in the IED, situate it at the place of target and walk away.
- e. When the time set on the timer is over, you are now ready to detonate the device using the remote.

If you need to disassemble the IED from its location follow these steps:

- a. Turn the metal rod on the timer in order to disconnect the circuit.
- b. Disconnect the battery and the detonator.

OUR TEST



In this experiment, the mujahid was about 70 meters away from the bomb in an open area. The city is not an open area so be within sight.



3. Manufacturing Grenades

There are many possibilities in the field of grenade manufacture, but for the most part, when you're dealing with grenades that must be constructed of easily available materials, the quality and the safety of the grenade is reduced dramatically. Here I will deal with this problem, trying to produce a reasonable type of grenade that is relatively safe, can be stored and transported easily, but produces dramatic effects. I strongly suggest that if you find it possible, you are far better off getting a REAL grenade than trying to produce one yourself, but you can be the judge. For quality end products it is recommended to follow the guide in Ragnar Benson's Big Book of Homemade Weapons (1992, Paladin Press).

Simple Fragmentation grenade

For a simple grenade, the first thing you need is explosives. You'll also need a coffee can, a smaller sized can (probably like an orange juice can, or V8), a coat hanger, and a fuse or fuze. As for explosives, mercury fulminate is extremely good for this sort of thing. You could probably get together a ton of firecrackers and take out the black powder (if you're desperate). The explosive goes in the juice can. Don't pack it together too tight. Loose black powder is better than compressed. This is the main explosive. Cut up the coat hanger into little pieces approximately 1/2" long and fill up the coffee can until you can put the juice can in and the top of the juice can is level with the top of the coffee can. If you don't have the time, and need to fill up the space faster, chuck in a couple small rocks or pieces of glass, and stuff like that until you have the bottom of the can filled. Now place the juice can in the coffee can, and center it. Then fill the space around the coffee can with coat hanger stuff until the juice can is relatively stable. Put a model rocket fuse in the explosive in the juice can. Leave (at least) 3 1/2" to light from. If necessary, secure the juice can or the explosive with some masking tape, etc... as long as it doesn't interfere with the action of the grenade. Take the lid of the coffee can and cut a hole so that the fuse is exposed.

You now have a fragmentation grenade.

Tennis Ball Bomb

This is a very simple grenade type projectile.

Ingredients:

1 tennis ball (not reuseable)

some good duct tape

1 Stanley utility knife (can be reused)

1 rocket fuse

some rubber cement

enough gun powder (or smoke powder) to fill the tennisball

1 permanent marker

some kind of drill

Directions:

Once all of the necessary items have been gather follow these simple steps and your good to go.

1. Take the tennis ball and clamp it into a vice.
2. Then take the marker and mark where you want the fuse to be.
3. After you have done this take the utility and cut around the marked spot

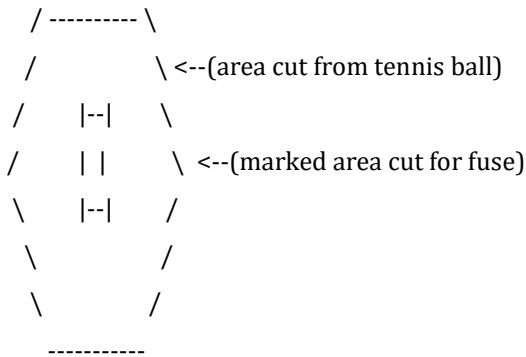

4. Then, fill the tennis ball with what ever the hell you want.

5. Now go back to the cut piece and drill the marked area and rubber cement it, and duct tape to reinforce the weak cut part.

6. Light and throw

Notes:

If you're going to use the smoke powder, you might want to cut another hole so the smoke has a place to go.

Nail (shrapnel) Grenade

Effective fragmentation grenade can be made from a block of TNT or other blasting explosive and nails

Material Required

Block of TNT or other blasting explosive

Nails

Non electric blasting cap

Fuse cord

Tape, string, wire, or glue

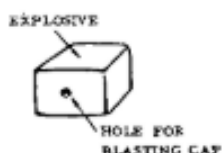

Procedure

1. If an explosive charge other than a standard TNT block is used, make a hole in the center of the charge for inserting the blasting cap. TNT can be drilled with relative safety. With plastic explosives, a hole can be made by pressing a round stick into the center of the charge. The hole should be deep enough that the blasting cap is totally within the explosive.



2. Tape, tie, or glue one or two rows of closely packed nails to sides of explosive block. Nails should completely cover the four surfaces of the block.



3. Place blasting cap on one end of the fuse cord and crimp with pliers.

Note: To find out how long the fuse cord should be, check the time it takes to burn 12 inches. If it takes 30 seconds, then a 15 second delay requires 6 inches, and a 10 second delay, 4 inches of fuse.

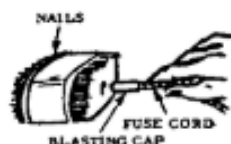

4. Insert the blasting cap in the hole in the block of explosive. Tape or tie fuse cord securely in place so that it will not fall out when the grenade is thrown.

Alternate use

An effective directional anti-personnel mine can be made by placing nails on only one side of the explosive block. In this case an electric blasting cap can be used.



Field improvised hand grenades can be made as described by the US Army as follows -

Pipe Hand Grenade

Hand grenades can be made from a piece of iron pipe. The filler can be plastic or granular military explosive, improvised explosive, or propellant from shotgun or small arms ammunition.

Material Required

Iron pipe, threaded ends, 1 1/2" to 3" dia. to 8" long
Two (2) iron pipe caps
Explosive or propellant
Nonelectric blasting cap
Fuse cord
Hand drill
Pliers

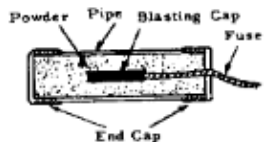

Procedure

1. Place blasting cap on one end of fuse cord and crimp with pliers.

Note: To find out how long the fuse cord should be, check the time it takes to burn a known length. If 12 inches burn in 30 seconds, a 6 in. cord will ignite a grenade in 15 seconds.

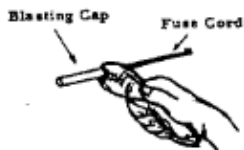

2. Screw pipe cap to one end of pipe. Place fuse cord with blasting cap into the opposite end so that the blasting cap is near the center of the pipe.

Note: If plastic explosive is to be used, fill pipe before inserting blasting cap. Push a round stick into the center of the explosive to make a hole and then insert the blasting cap.

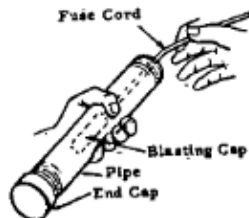

3. Pour explosive or propellant into pipe a little bit at a time. Tap the base of the pipe frequently to settle filler.

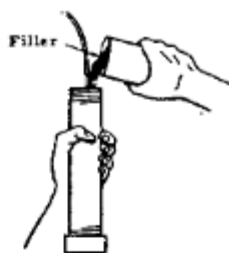

4. Drill a hole in the center of the unassembled pipe cap large enough for the fuse cord to pass through.

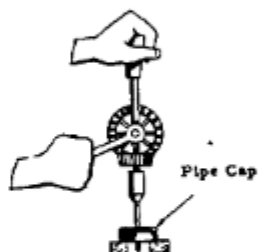

5. Wipe pipe threads to remove any filler material.

Slide drilled pipe cap over the fuse and screw handtight onto the pipe.



MAKING A HAND GRENADE REQUIRES 3 STEPS:



A - DESIGNING THE CIRCUIT



B - PREPARING THE IGNITOR



C - PREPARING THE GRENADE

A | DESIGNING THE CIRCUIT

ITEMS REQUIRED



1 - 9v Battery



2 - Christmas Lamp



3 - Two wires, red and black



4 - Toggle switch



5 - Push switch

OBTAINING THE SWITCHES

A- SAFETY SWITCH

This type of switch is mostly found in electronic devices. Here we used a switch from a small lamp.

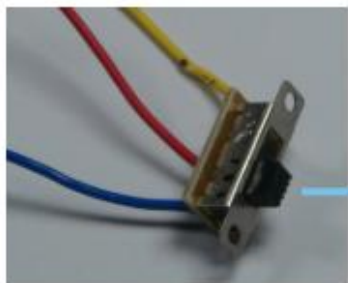

REMOVING THE SWITCH



1. Remove the outer cover of the outer switch.



2. Unscrew the lamp and dismantle it.



3. Cut all the wires connecting to the switch from the lamp.

B - THE EXECUTION SWITCH.

This push switch is found in a variety of devices. we obtained it by removing it from a lamp, using the same method as above.



CONNECTING THE CIRCUIT

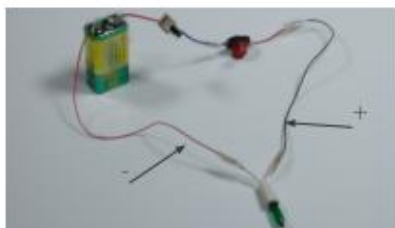
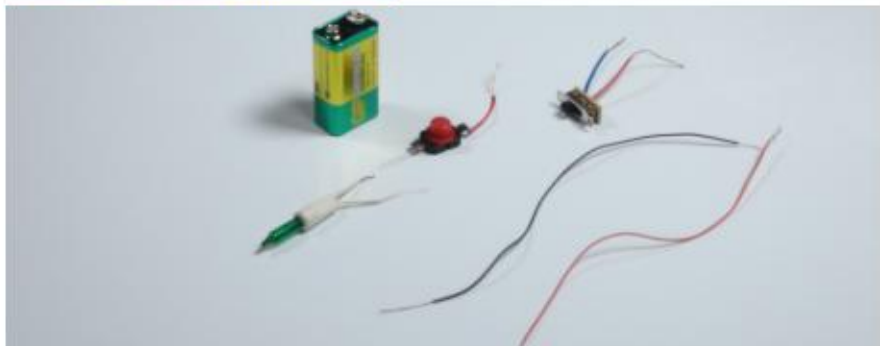

1. Connect the two switches using the same positive wire. Then connect the entire circuit.



2. We open the safety switch (switch-on the toggle switch).

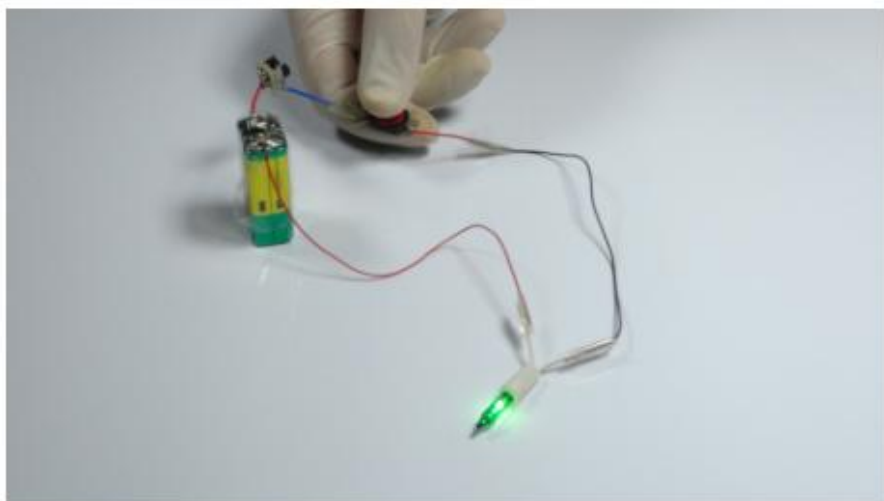

3. When we press the executing switch (Push Switch), the circuit is connected.

B | PREPARING THE DELAYED IGNITOR



1. Gently heat the tip of the lamp.



2. Immediately dip the lamp in water.



3. Cautiously break the head of the lamp



4. Fill the lamp with fireworks powder.

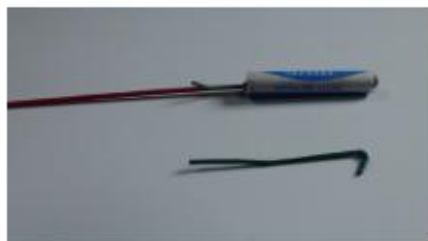

5. Remove the fuse from the firework.



6. Insert the fuse inside the lamp, and close it firmly with a tape.

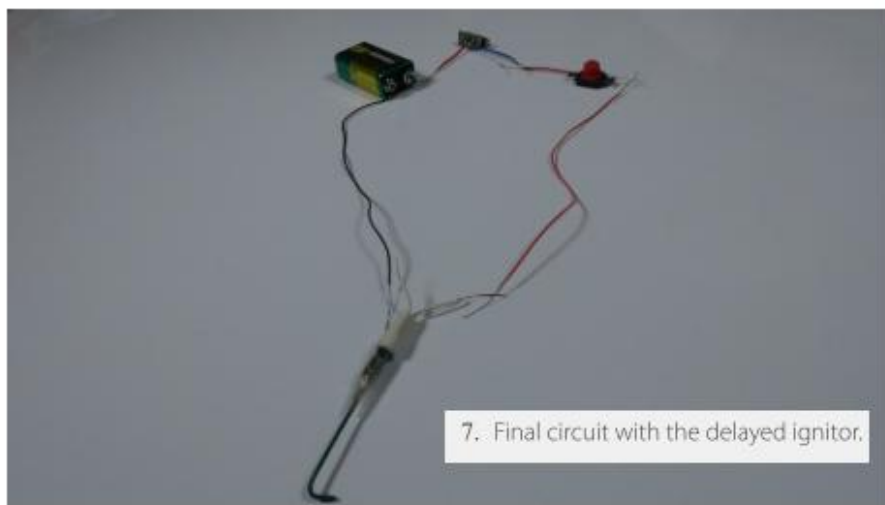

7. Final circuit with the delayed ignitor.

C | PREPARING THE HAND GRENADE



1. We will use a 1.5 inch metal elbow pipe, as shown above.



2. Drill a small hole as shown.



3. Place shrapnel in the inner sides of the pipe using glue.



4. Final results after attaching shrapnel.



5. Fill the pipe with fireworks powder.



6. Wipe the internal screw thread with a cloth so as not to ignite the fireworks while sealing the pipe.



7. Close the pipe.

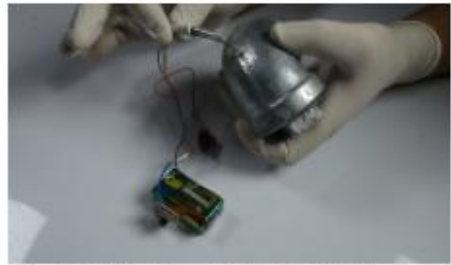

8. Insert the fuse inside the drilled hole.



And now this simple timed hand grenade is ready for use. When the trigger switch (toggle-switch) is pulled and the execution switch is pressed, the grenade will delay for three seconds then explode.

D

SAFETY AND PRECAUTIONS



It is important that the igniter and the fuse take the form of approximately 45° , so as to burn the tip of the igniter only and not the whole fuse all at once.

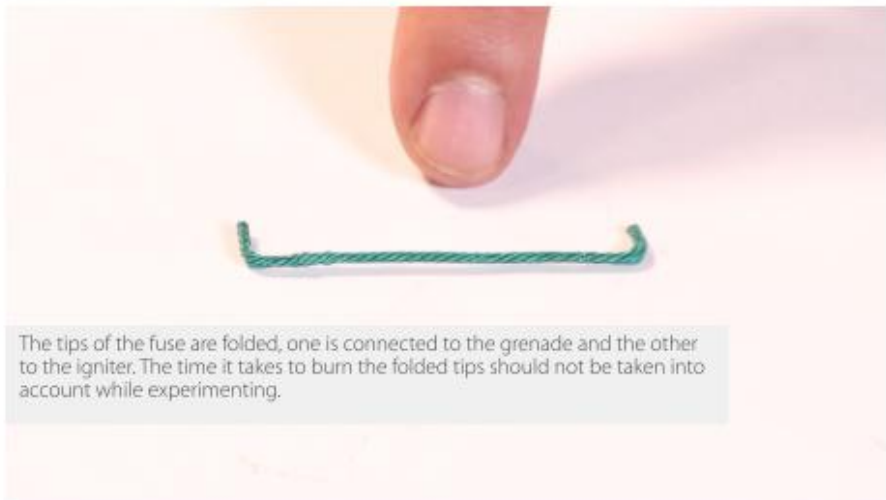

The tips of the fuse are folded, one is connected to the grenade and the other to the igniter. The time it takes to burn the folded tips should not be taken into account while experimenting.



- Confirm and test the circuit using a Christmas lamp before connecting the wires to the fuse.

E EXPERIMENTING

It took approximately 3 seconds for the fuse to completely burn

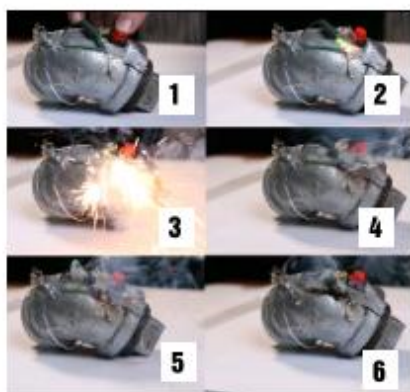

EXPERIMENTING WITH THE EXPLOSION

The hand Grenade before explosion



Tear Gas Grenade

The steps for making tear gas are included below. Finding an explosive container for the tear gas can be as simple as putting a stick of explosive into a plastic bottle then filling it with the gas. Screw the cap on tightly making sure your ignition mechanism can be activated from the outside. Creation of riot police style tear gas grenades is a topic you might want to research yourself.

EQUIPMENT

1. ring stands (2) 2. alcohol burner 3. erlenmeyer flask, 300 ml 4. clamps (2) 5. rubber stopper 6. glass tubing 7. clamp holder 8. condenser 9. rubber tubing 10. collecting flask 11. air trap 12. beaker, 300 ml

MATERIALS

10g glycerine

2 g sodium bisulfate

distilled water

- 1) In an open area, wearing a gas mask, mix 10 gms of glycerine with 2 gms of sodium bisulfate in the 300 ml erlenmeyer flask.
- 2) Light the alcohol burner, and gently heat the flask. 3) The mixture will begin to bubble and froth; these bubbles are tear gas.
- 4) When the mixture being heated ceases to froth and generate gas, or a brown residue becomes visible in the tube, the reaction is complete. Remove the heat source, and dispose of the heated mixture, as it is corrosive.
- 5) The material that condenses in the condenser and drips into the collecting flask is tear gas. It must be capped tightly, and stored in a safe place.

SMOKE GRENADE+

Materials:

Potassium Nitrate (finely ground)
Sugar
Baking soda
Cannon fuse (2 second/inch)
matchbox
sealable Monster drink can or large plastic container with lid
saucepan/heat source
duct tape
centerpunch or screwdriver



Optional:

food coloring powder (baking supply or spiceplace.com)
concentrated wasabi powder (spiceplace.com)
sulfur powder

Cut a good 3 to 4 inches of cannon fuse. Keep nearby.
Mix 40% sugar to 60% potassium nitrate with a teaspoon of baking soda to every 2 cups of mix. Add to saucepan.
Heat VERY gently, increasing the heat slowly. Mix constantly.
Mixture will begin to clump, then spots will begin to brown.



When it reduces to a consistency of pancake batter, remove from heat. Carefully pour into your selected shell until it is 9/10s full. Wipe excess away from shell if mixture rises over the edge. Add your fuse so 1/2 of it is above the level of the mixture. Allow to cool and harden.

Punch a hole through the middle of your can/container lid. thread fuse through and secure the lid. You can



hot glue around the fuse and around the lid to seal it against humidity.

Lay a strip of duct tape out and evenly space 5 wooden matches about 1mm apart. Tightly wrap around the cannon fuse so that the match tips surround the end of the fuse. Apply a butt ton of duct tape, securing the match fuse assembly to the shell in a conical formation, careful to leave the match heads exposed. This is to stabilize, strenthen, and weatherproof it to a degree

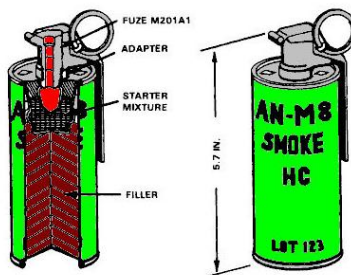

Fold a strip of the matchbox with the strikeface so that it resembles an angular U shape. Place tightly around the match head/fuse assembly and tape it up completely so that there is no gaps within the cardboard tab you just made. The tab should not fall off when rolled upside down, but come off when pulled on. (DO NOT DO THIS) Add a safety system by adding a rubber band or fastening a single piece of electrical tape over the pull-tab to the main shell.

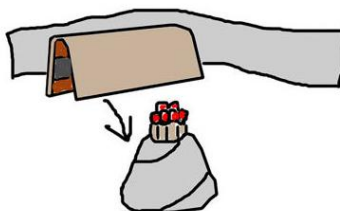

The pull tab fuse is NOT weatherproof, so keep it dry. And a year or so in humid weather ill probably mean you need to replace the matches and tape, but the cannon fuse and the rest is sealed and should be okay.

Optional:

Colored Smoke Grenade: Make your mix 60% potassium nitrate, 30% sugar, and 10% powdered food coloring.

Irritant Gas grenade: Make your mix 50% potassium nitrate, 30% sugar, and 20% concentrated wasabi powder.



-Poison- Gas Grenade: Make your mix 60% potassium nitrate and 40% sulfur. Add no baking soda. **WARNING:** this mixture produces very high levels of pure hydrogen sulfide gas, which is quickly lethal in enclosed spaces.



4. Manufacturing larger bombs and advanced bomb making

Naturally, larger targets require more explosives. There is no perfect blueprint for larger bombs. Generally it is recommended to only use insensitive and low cost explosives for larger targets. Rockets and other payload delivery systems are spectacular and effective. In guerrilla warfare the use of mortars is highly recommended for many reasons best summarized in the Turner Diaries: "Mortars are marvellous little weapons, especially for guerrilla warfare. They drop their deadly rounds silently and almost vertically onto their target. They can be fired from total cover, and persons in the target area cannot tell from which direction the projectiles are coming." Creating the ammunition and launchers for advanced weapons systems is outside of the scope of SS Paladin but information about it can be found in, among other resources:

- Ragnar Benson's Big Book of Homemade Weapons
- Scientific Principles of Improvised Warfare and Home Defense Volume 3 History, Design, and Manufacture of Explosives
- TM 31-210 Improvised Munitions Handbook
- Poor Man's RPG by George Dmitrieff
- Terrorist's Handbook by CHAOS industries
- <http://www.interestingprojects.com/cruisemissile/>



1. Atomic Bombs

For final victory no measure is too extreme, nor casualty number too high. If going down this route, be sure to have a valid target in mind such as Tel Aviv, Washington DC, Mecca or any other target which will lead to the destruction of the Zionist Occupational Government.

Things you will need:

- About 50 pounds of weapons grade Plutonium, which can be picked up from your local convenience store, or you may want to get in touch with your local terrorist group. Expect to pay between \$5000 and \$30000 depending on the quality. (Or make your own by bombarding bismuth with neutrons. Step One: Bake a cylinder of bismuth in a nuclear reactor in an area of high flux of thermal neutrons. Step Two: Use zone melting to separate out the polonium: a heat source is moved up and down the length of the cylinder and this drives the unusual elements along with the heat. A semiconductor plant could have equipment for zone refining.)
- 2 metal enclosures - one must be a container to hold the plutonium, the other to hold item 3; you can use a briefcase, lunch box, or car.
- 100 Pounds of TNT
- VERY remote detonator
- Another identity for when you finish up...

Here's what you need to do in order to be the proud owner of your very own thermo-nuclear device.

Step 1. SAFETY PRECAUTIONS: Plutonium is a very dangerous element. You should wash your hands with soap and warm water after handling, and you should not feed it to your pet or children. You may want to store the plutonium in a lead box while you're working with it.

Step 2. Take your plutonium and mold in into 2 hemispheres inside your metal enclosure number 1. You can keep the plutonium together with rubber cement. Separate the two hemispheres with about 4 CM.

Step 3. Put your new Plutonium Box with the 2 hemispheres in it and put it in the larger metal container (car). Pack the TNT all around the Plutonium Box evenly. Make sure that you don't drive the car with the plutonium in it after final assembly

as a slight vibration can cause the detonation to occur ahead of schedule...

Step 4. Find a VERY remote detonation method - probably want to use radio or micro waves or some sort of cell phone based apparatus to light the TNT. When the TNT is detonated, the plutonium will be crushed, pushing the red-line for the atomic integrity. The chain reaction will occur.

Advanced considerations

Detonating Head

The detonating head (or heads, depending on whether a Uranium or Plutonium bomb is being used as a model) that is seated in the conventional explosive charge(s) is similar to the standard-issue blasting cap. It merely serves as a catalyst to bring about a greater explosion. Calibration of this device is essential. Too small of a detonating head will only cause a colossal dud that will be doubly dangerous since someone's got to disarm and re-fit the bomb with another detonating head. (an added measure of discomfort comes from the knowledge that the conventional explosive may have detonated with insufficient force to weld the radioactive metals. This will cause a supercritical mass that could go off at any time.)

Conventional Explosive Charge(s)

This explosive is used to introduce (and weld) the lesser amount of Uranium to the greater amount within the bomb's housing. [The amount of pressure needed to bring this about is unknown and possibly classified by the United States Government for reasons of National Security]

Plastic explosives work best in this situation since they can be manipulated to enable both a Uranium bomb and a Plutonium bomb to detonate. One very good explosive is Urea Nitrate. The directions on how to make Urea Nitrate are as follows:

Ingredients

- 1) 1 cup concentrated solution of uric acid (C₅ H₄ N₄ O₃)
- 2) 1/3 cup of nitric acid
- 3) 4 heat-resistant glass containers
- 4) 4 filters (coffee filters will do)

Filter the concentrated solution of uric acid through a filter to remove impurities. Slowly add 1/3 cup of nitric acid to the solution and let the mixture stand for 1 hour. Filter again as before. This time the Urea Nitrate crystals will collect on the

filter. Wash the crystals by pouring water over them while they are in the filter. Remove the crystals from the filter and allow 16 hours for them to dry.

Lead Shield

The lead shield's only purpose is to prevent the inherent radioactivity of the bomb's payload from interfering with the other mechanisms of the bomb. The neutron flux of the bomb's payload is strong enough to short circuit the internal circuitry and cause an accidental or premature detonation.

Fuses

The fuses are implemented as another safeguard to prevent an accidental detonation of both the conventional explosives and the nuclear payload. These fuses are set near the surface of the `nose' of the bomb so that they can be installed easily when the bomb is ready to be launched. The fuses should be installed only shortly before the bomb is launched. To affix them before it is time could result in an accident of catastrophic proportions.

XVII. The Art of War

Sun Tzu

I. Laying Plans

1. Sun Tzu said: The art of war is of vital importance to the State.
2. It is a matter of life and death, a road either to safety or to ruin. Hence it is a subject of inquiry which can on no account be neglected.
3. The art of war, then, is governed by five constant factors, to be taken into account in one's deliberations, when seeking to determine the conditions obtaining in the field.
4. These are: (1) The Moral Law; (2) Heaven; (3) Earth; (4) The Commander; (5) Method and discipline.
- 5,6. The Moral Law causes the people to be in complete accord with their ruler, so that they will follow him regardless of their lives, undismayed by any danger.
7. Heaven signifies night and day, cold and heat, times and seasons.
8. Earth comprises distances, great and small; danger and security; open ground and narrow passes; the chances of life and death.
9. The Commander stands for the virtues of wisdom, sincerely, benevolence, courage and strictness.
10. By method and discipline are to be understood the marshaling of the army in its proper subdivisions, the graduations of rank among the officers, the maintenance of roads by which supplies may reach the army, and the control of military expenditure.
11. These five heads should be familiar to every general: he who knows them will be victorious; he who knows them not will fail.
12. Therefore, in your deliberations, when seeking to determine the military conditions, let them be made the basis of a comparison, in this wise:-13. (1) Which of the two sovereigns is imbued with the Moral law? (2) Which of the two generals has most ability? (3) With whom lie the advantages derived from Heaven and Earth? (4) On which side is discipline most rigorously enforced? (5) Which army is stronger? (6) On which side are officers and men more highly trained? (7) In which army is there the greater constancy both in reward and punishment?
14. By means of these seven considerations I can forecast victory or defeat.
15. The general that hearkens to my counsel and acts upon it, will conquer: let such a one be retained in command! The general that hearkens not to my counsel nor acts upon it, will suffer defeat--let such a one be dismissed!
16. While heading the profit of my counsel, avail yourself also of any helpful circumstances over and beyond the ordinary rules.
17. According as circumstances are favorable, one should modify one's plans.
18. All warfare is based on deception.
19. Hence, when able to attack, we must seem unable; when using our forces, we must seem inactive; when we are near, we must make the enemy believe we are far away; when far away, we must make him believe we are near.

20. Hold out baits to entice the enemy. Feign disorder, and crush him.
21. If he is secure at all points, be prepared for him. If he is in superior strength, evade him.
22. If your opponent is of choleric temper, seek to irritate him. Pretend to be weak, that he may grow arrogant.
23. If he is taking his ease, give him no rest. If his forces are united, separate them.
24. Attack him where he is unprepared, appear where you are not expected.
25. These military devices, leading to victory, must not be divulged beforehand.
26. Now the general who wins a battle makes many calculations in his temple ere the battle is fought. The general who loses a battle makes but few calculations beforehand. Thus do many calculations lead to victory, and few calculations to defeat: how much more no calculation at all! It is by attention to this point that I can foresee who is likely to win or lose.

II. Waging War

1. Sun Tzu said: In the operations of war, where there are in the field a thousand swift chariots, as many heavy chariots, and a hundred thousand mail-clad soldiers, with provisions enough to carry them a thousand li, the expenditure at home and at the front, including entertainment of guests, small items such as glue and paint, and sums spent on chariots and armor, will reach the total of a thousand ounces of silver per day. Such is the cost of raising an army of 100,000 men.
2. When you engage in actual fighting, if victory is long in coming, then men's weapons will grow dull and their ardor will be damped. If you lay siege to a town, you will exhaust your strength.
3. Again, if the campaign is protracted, the resources of the State will not be equal to the strain.
4. Now, when your weapons are dulled, your ardor damped, your strength exhausted and your treasure spent, other chieftains will spring up to take advantage of your extremity. Then no man, however wise, will be able to avert the consequences that must ensue.
5. Thus, though we have heard of stupid haste in war, cleverness has never been seen associated with long delays.
6. There is no instance of a country having benefited from prolonged warfare.
7. It is only one who is thoroughly acquainted with the evils of war that can thoroughly understand the profitable way of carrying it on.
8. The skillful soldier does not raise a second levy, neither are his supply-wagons loaded more than twice.
9. Bring war material with you from home, but forage on the enemy. Thus the army will have food enough for its needs.
10. Poverty of the State exchequer causes an army to be maintained by contributions from a distance. Contributing to maintain an army at a distance causes the people to be impoverished.
11. On the other hand, the proximity of an army causes prices to go up; and high prices cause the people's substance to be drained away.

12. When their substance is drained away, the peasantry will be afflicted by heavy exactions.

13,14. With this loss of substance and exhaustion of strength, the homes of the people will be stripped bare, and three-tenths of their income will be dissipated; while government expenses for broken chariots, worn-out horses, breast-plates and helmets, bows and arrows, spears and shields, protective mantles, draught-oxen and heavy wagons, will amount to four-tenths of its total revenue.

15. Hence a wise general makes a point of foraging on the enemy. One cart load of the enemy's provisions is equivalent to twenty of one's own, and likewise a single picul of his provender is equivalent to twenty from one's own store.

16. Now in order to kill the enemy, our men must be roused to anger; that there may be advantage from defeating the enemy, they must have their rewards.

17. Therefore in chariot fighting, when ten or more chariots have been taken, those should be rewarded who took the first. Our own flags should be substituted for those of the enemy, and the chariots mingled and used in conjunction with ours. The captured soldiers should be kindly treated and kept.

18. This is called, using the conquered foe to augment one's own strength. 19. In war, then, let your great object be victory, not lengthy campaigns.

20. Thus it may be known that the leader of armies is the arbiter of the people's fate, the man on whom it depends whether the nation shall be in peace or in peril.

III. Attack by Stratagem

1. Sun Tzu said: In the practical art of war, the best thing of all is to take the enemy's country whole and intact; to shatter and destroy it is not so good. So, too, it is better to recapture an army entire than to destroy it, to capture a regiment, a detachment or a company entire than to destroy them.

2. Hence to fight and conquer in all your battles is not supreme excellence; supreme excellence consists in breaking the enemy's resistance without fighting.

3. Thus the highest form of generalship is to balk the enemy's plans; the next best is to prevent the junction of the enemy's forces; the next in order is to attack the enemy's army in the field; and the worst policy of all is to besiege walled cities.

4. The rule is, not to besiege walled cities if it can possibly be avoided. The preparation of mantlets, movable shelters, and various implements of war, will take up three whole months; and the piling up of mounds over against the walls will take three months more.

5. The general, unable to control his irritation, will launch his men to the assault like swarming ants, with the result that one-third of his men are slain, while the town still remains untaken. Such are the disastrous effects of a siege.

6. Therefore the skillful leader subdues the enemy's troops without any fighting; he captures their cities without laying siege to them; he overthrows their kingdom without lengthy operations in the field.

7. With his forces intact he will dispute the mastery of the Empire, and thus, without losing a man, his triumph will be complete. This is the method of attacking by stratagem.

8. It is the rule in war, if our forces are ten to the enemy's one, to surround him; if five to one, to attack him; if twice as numerous, to divide our army into two.

9. If equally matched, we can offer battle; if slightly inferior in numbers, we can avoid the enemy; if quite unequal in every way, we can flee from him.

10. Hence, though an obstinate fight may be made by a small force, in the end it must be captured by the larger force.

11. Now the general is the bulwark of the State; if the bulwark is complete at all points; the State will be strong; if the bulwark is defective, the State will be weak.

12. There are three ways in which a ruler can bring misfortune upon his army:-

13. (1) By commanding the army to advance or to retreat, being ignorant of the fact that it cannot obey. This is called hobbling the army.

14. (2) By attempting to govern an army in the same way as he administers a kingdom, being ignorant of the conditions which obtain in an army. This causes restlessness in the soldier's minds.

15. (3) By employing the officers of his army without discrimination, through ignorance of the military principle of adaptation to circumstances. This shakes the confidence of the soldiers.

16. But when the army is restless and distrustful, trouble is sure to come from the other feudal princes. This is simply bringing anarchy into the army, and flinging victory away.

17. Thus we may know that there are five essentials for victory: (1) He will win who knows when to fight and when not to fight. (2) He will win who knows how to handle both superior and inferior forces. (3) He will win whose army is animated by the same spirit throughout all its ranks. (4) He will win who, prepared himself, waits to take the enemy unprepared. (5) He will win who has military capacity and is not interfered with by the sovereign.

18. Hence the saying: If you know the enemy and know yourself, you need not fear the result of a hundred battles. If you know yourself but not the enemy, for every victory gained you will also suffer a defeat. If you know neither the enemy nor yourself, you will succumb in every battle.

IV. Tactical Dispositions

1. Sun Tzu said: The good fighters of old first put themselves beyond the possibility of defeat, and then waited for an opportunity of defeating the enemy.

2. To secure ourselves against defeat lies in our own hands, but the opportunity of defeating the enemy is provided by the enemy himself.

3. Thus the good fighter is able to secure himself against defeat, but cannot make certain of defeating the enemy.

4. Hence the saying: One may know how to conquer without being able to do it.

5. Security against defeat implies defensive tactics; ability to defeat the enemy means taking the offensive.

6. Standing on the defensive indicates insufficient strength; attacking, a superabundance of strength.

7. The general who is skilled in defense hides in the most secret recesses of the

earth; he who is skilled in attack flashes forth from the topmost heights of heaven. Thus on the one hand we have ability to protect ourselves; on the other, a victory that is complete.

8. To see victory only when it is within the ken of the common herd is not the acme of excellence.

9. Neither is it the acme of excellence if you fight and conquer and the whole Empire says, "Well done!"

10. To lift an autumn hair is no sign of great strength; to see the sun and moon is no sign of sharp sight; to hear the noise of thunder is no sign of a quick ear.

11. What the ancients called a clever fighter is one who not only wins, but excels in winning with ease.

12. Hence his victories bring him neither reputation for wisdom nor credit for courage.

13. He wins his battles by making no mistakes. Making no mistakes is what establishes the certainty of victory, for it means conquering an enemy that is already defeated.

14. Hence the skillful fighter puts himself into a position which makes defeat impossible, and does not miss the moment for defeating the enemy.

15. Thus it is that in war the victorious strategist only seeks battle after the victory has been won, whereas he who is destined to defeat first fights and afterwards looks for victory.

16. The consummate leader cultivates the moral law, and strictly adheres to method and discipline; thus it is in his power to control success.

17. In respect of military method, we have, firstly, Measurement; secondly, Estimation of quantity; thirdly, Calculation; fourthly, Balancing of chances; fifthly, Victory.

18. Measurement owes its existence to Earth; Estimation of quantity to Measurement; Calculation to Estimation of quantity; Balancing of chances to Calculation; and Victory to Balancing of chances.

19. A victorious army opposed to a routed one, is as a pound's weight placed in the scale against a single grain.

20. The onrush of a conquering force is like the bursting of pent-up waters into a chasm a thousand fathoms deep.

V. Energy

1. Sun Tzu said: The control of a large force is the same principle as the control of a few men: it is merely a question of dividing up their numbers.

2. Fighting with a large army under your command is nowise different from fighting with a small one: it is merely a question of instituting signs and signals.

3. To ensure that your whole host may withstand the brunt of the enemy's attack and remain unshaken-- this is effected by maneuvers direct and indirect.

4. That the impact of your army may be like a grindstone dashed against an egg-- this is effected by the science of weak points and strong.

5. In all fighting, the direct method may be used for joining battle, but indirect

methods will be needed in order to secure victory.

6. Indirect tactics, efficiently applied, are inexhaustible as Heaven and Earth, unending as the flow of rivers and streams; like the sun and moon, they end but to begin anew; like the four seasons, they pass away to return once more.

7. There are not more than five musical notes, yet the combinations of these five give rise to more melodies than can ever be heard.

8. There are not more than five primary colors (blue, yellow, red, white, and black), yet in combination they produce more hues than can ever been seen.

9. There are not more than five cardinal tastes (sour, acrid, salt, sweet, bitter), yet combinations of them yield more flavors than can ever be tasted.

10. In battle, there are not more than two methods of attack--the direct and the indirect; yet these two in combination give rise to an endless series of maneuvers.

11. The direct and the indirect lead on to each other in turn. It is like moving in a circle--you never come to an end. Who can exhaust the possibilities of their combination?

12. The onset of troops is like the rush of a torrent which will even roll stones along in its course.

13. The quality of decision is like the well-timed swoop of a falcon which enables it to strike and destroy its victim.

14. Therefore the good fighter will be terrible in his onset, and prompt in his decision.

15. Energy may be likened to the bending of a crossbow; decision, to the releasing of a trigger.

16. Amid the turmoil and tumult of battle, there may be seeming disorder and yet no real disorder at all; amid confusion and chaos, your array may be without head or tail, yet it will be proof against defeat.

17. Simulated disorder postulates perfect discipline, simulated fear postulates courage; simulated weakness postulates strength.

18. Hiding order beneath the cloak of disorder is simply a question of subdivision; concealing courage under a show of timidity presupposes a fund of latent energy; masking strength with weakness is to be effected by tactical dispositions.

19. Thus one who is skillful at keeping the enemy on the move maintains deceitful appearances, according to which the enemy will act. He sacrifices something, that the enemy may snatch at it.

20. By holding out baits, he keeps him on the march; then with a body of picked men he lies in wait for him.

21. The clever combatant looks to the effect of combined energy, and does not require too much from individuals. Hence his ability to pick out the right men and utilize combined energy.

22. When he utilizes combined energy, his fighting men become as it were like unto rolling logs or stones. For it is the nature of a log or stone to remain motionless on level ground, and to move when on a slope; if four-cornered, to come to a standstill, but if round-shaped, to go rolling down.

23. Thus the energy developed by good fighting men is as the momentum of a

round stone rolled down a mountain thousands of feet in height. So much on the subject of energy.

VI. Weak Points and Strong

1. Sun Tzu said: Whoever is first in the field and awaits the coming of the enemy, will be fresh for the fight; whoever is second in the field and has to hasten to battle will arrive exhausted.
2. Therefore the clever combatant imposes his will on the enemy, but does not allow the enemy's will to be imposed on him.
3. By holding out advantages to him, he can cause the enemy to approach of his own accord; or, by inflicting damage, he can make it impossible for the enemy to draw near.
4. If the enemy is taking his ease, he can harass him; if well supplied with food, he can starve him out; if quietly encamped, he can force him to move.
5. Appear at points which the enemy must hasten to defend; march swiftly to places where you are not expected.
6. An army may march great distances without distress, if it marches through country where the enemy is not.
7. You can be sure of succeeding in your attacks if you only attack places which are undefended. You can ensure the safety of your defense if you only hold positions that cannot be attacked.
8. Hence that general is skillful in attack whose opponent does not know what to defend; and he is skillful in defense whose opponent does not know what to attack.
9. O divine art of subtlety and secrecy! Through you we learn to be invisible, through you inaudible; and hence we can hold the enemy's fate in our hands.
10. You may advance and be absolutely irresistible, if you make for the enemy's weak points; you may retire and be safe from pursuit if your movements are more rapid than those of the enemy.
11. If we wish to fight, the enemy can be forced to an engagement even though he be sheltered behind a high rampart and a deep ditch. All we need do is attack some other place that he will be obliged to relieve.
12. If we do not wish to fight, we can prevent the enemy from engaging us even though the lines of our encampment be merely traced out on the ground. All we need do is to throw something odd and unaccountable in his way.
13. By discovering the enemy's dispositions and remaining invisible ourselves, we can keep our forces concentrated, while the enemy's must be divided.
14. We can form a single united body, while the enemy must split up into fractions. Hence there will be a whole pitted against separate parts of a whole, which means that we shall be many to the enemy's few.
15. And if we are able thus to attack an inferior force with a superior one, our opponents will be in dire straits.
16. The spot where we intend to fight must not be made known; for then the enemy will have to prepare against a possible attack at several different points; and his forces being thus distributed in many directions, the numbers we shall

have to face at any given point will be proportionately few.

17. For should the enemy strengthen his van, he will weaken his rear; should he strengthen his rear, he will weaken his van; should he strengthen his left, he will weaken his right; should he strengthen his right, he will weaken his left. If he sends reinforcements everywhere, he will everywhere be weak.

18. Numerical weakness comes from having to prepare against possible attacks; numerical strength, from compelling our adversary to make these preparations against us.

19. Knowing the place and the time of the coming battle, we may concentrate from the greatest distances in order to fight.

20. But if neither time nor place be known, then the left wing will be impotent to succor the right, the right equally impotent to succor the left, the van unable to relieve the rear, or the rear to support the van. How much more so if the furthest portions of the army are anything under a hundred LI apart, and even the nearest are separated by several LI!

21. Though according to my estimate the soldiers of Yueh exceed our own in number, that shall advantage them nothing in the matter of victory. I say then that victory can be achieved.

22. Though the enemy be stronger in numbers, we may prevent him from fighting. Scheme so as to discover his plans and the likelihood of their success.

23. Rouse him, and learn the principle of his activity or inactivity. Force him to reveal himself, so as to find out his vulnerable spots.

24. Carefully compare the opposing army with your own, so that you may know where strength is superabundant and where it is deficient.

25. In making tactical dispositions, the highest pitch you can attain is to conceal them; conceal your dispositions, and you will be safe from the prying of the subtlest spies, from the machinations of the wisest brains.

26. How victory may be produced for them out of the enemy's own tactics--that is what the multitude cannot comprehend.

27. All men can see the tactics whereby I conquer, but what none can see is the strategy out of which victory is evolved.

28. Do not repeat the tactics which have gained you one victory, but let your methods be regulated by the infinite variety of circumstances.

29. Military tactics are like unto water; for water in its natural course runs away from high places and hastens downwards.

30. So in war, the way is to avoid what is strong and to strike at what is weak.

31. Water shapes its course according to the nature of the ground over which it flows; the soldier works out his victory in relation to the foe whom he is facing.

32. Therefore, just as water retains no constant shape, so in warfare there are no constant conditions.

33. He who can modify his tactics in relation to his opponent and thereby succeed in winning, may be called a heaven-born captain.

34. The five elements (water, fire, wood, metal, earth) are not always equally predominant; the four seasons make way for each other in turn. There are short

days and long; the moon has its periods of waning and waxing.

VII. Maneuvering

1. Sun Tzu said: In war, the general receives his commands from the sovereign.
2. Having collected an army and concentrated his forces, he must blend and harmonize the different elements thereof before pitching his camp.
3. After that, comes tactical maneuvering, than which there is nothing more difficult. The difficulty of tactical maneuvering consists in turning the devious into the direct, and misfortune into gain.
4. Thus, to take a long and circuitous route, after enticing the enemy out of the way, and though starting after him, to contrive to reach the goal before him, shows knowledge of the artifice of deviation.
5. Maneuvering with an army is advantageous; with an undisciplined multitude, most dangerous.
6. If you set a fully equipped army in march in order to snatch an advantage, the chances are that you will be too late. On the other hand, to detach a flying column for the purpose involves the sacrifice of its baggage and stores.
7. Thus, if you order your men to roll up their buff-coats, and make forced marches without halting day or night, covering double the usual distance at a stretch, doing a hundred LI in order to wrest an advantage, the leaders of all your three divisions will fall into the hands of the enemy.
8. The stronger men will be in front, the jaded ones will fall behind, and on this plan only one-tenth of your army will reach its destination.
9. If you march fifty LI in order to outmaneuver the enemy, you will lose the leader of your first division, and only half your force will reach the goal.
10. If you march thirty LI with the same object, two-thirds of your army will arrive.
11. We may take it then that an army without its baggage-train is lost; without provisions it is lost; without bases of supply it is lost.
12. We cannot enter into alliances until we are acquainted with the designs of our neighbors.
13. We are not fit to lead an army on the march unless we are familiar with the face of the country--its mountains and forests, its pitfalls and precipices, its marshes and swamps.
14. We shall be unable to turn natural advantage to account unless we make use of local guides.
15. In war, practice dissimulation, and you will succeed.
16. Whether to concentrate or to divide your troops, must be decided by circumstances.
17. Let your rapidity be that of the wind, your compactness that of the forest.
18. In raiding and plundering be like fire, in immovability like a mountain.
19. Let your plans be dark and impenetrable as night, and when you move, fall like a thunderbolt.
20. When you plunder a countryside, let the spoil be divided amongst your men;

when you capture new territory, cut it up into allotments for the benefit of the soldiery.

21. Ponder and deliberate before you make a move.

22. He will conquer who has learnt the artifice of deviation. Such is the art of maneuvering.

23. The Book of Army Management says: On the field of battle, the spoken word does not carry far enough: hence the institution of gongs and drums. Nor can ordinary objects be seen clearly enough: hence the institution of banners and flags.

24. Gongs and drums, banners and flags, are means whereby the ears and eyes of the host may be focused on one particular point.

25. The host thus forming a single united body, is it impossible either for the brave to advance alone, or for the cowardly to retreat alone. This is the art of handling large masses of men.

26. In night-fighting, then, make much use of signal-fires and drums, and in fighting by day, of flags and banners, as a means of influencing the ears and eyes of your army.

27. A whole army may be robbed of its spirit; a commander-in-chief may be robbed of his presence of mind.

28. Now a soldier's spirit is keenest in the morning; by noonday it has begun to flag; and in the evening, his mind is bent only on returning to camp.

29. A clever general, therefore, avoids an army when its spirit is keen, but attacks it when it is sluggish and inclined to return. This is the art of studying moods.

30. Disciplined and calm, to await the appearance of disorder and hubbub amongst the enemy:--this is the art of retaining self-possession.

31. To be near the goal while the enemy is still far from it, to wait at ease while the enemy is toiling and struggling, to be well-fed while the enemy is famished:--this is the art of husbanding one's strength.

32. To refrain from intercepting an enemy whose banners are in perfect order, to refrain from attacking an army drawn up in calm and confident array:--this is the art of studying circumstances.

33. It is a military axiom not to advance uphill against the enemy, nor to oppose him when he comes downhill.

34. Do not pursue an enemy who simulates flight; do not attack soldiers whose temper is keen.

35. Do not swallow bait offered by the enemy. Do not interfere with an army that is returning home.

36. When you surround an army, leave an outlet free. Do not press a desperate foe too hard.

37. Such is the art of warfare.

VIII. Variation in Tactics

1. Sun Tzu said: In war, the general receives his commands from the sovereign, collects his army and concentrates his forces

2. When in difficult country, do not encamp. In country where high roads intersect,

join hands with your allies. Do not linger in dangerously isolated positions. In hemmed-in situations, you must resort to stratagem. In desperate position, you must fight.

3. There are roads which must not be followed, armies which must be not attacked, towns which must be besieged, positions which must not be contested, commands of the sovereign which must not be obeyed.

4. The general who thoroughly understands the advantages that accompany variation of tactics knows how to handle his troops.

5. The general who does not understand these, may be well acquainted with the configuration of the country, yet he will not be able to turn his knowledge to practical account.

6. So, the student of war who is unversed in the art of war of varying his plans, even though he be acquainted with the Five Advantages, will fail to make the best use of his men.

7. Hence in the wise leader's plans, considerations of advantage and of disadvantage will be blended together.

8. If our expectation of advantage be tempered in this way, we may succeed in accomplishing the essential part of our schemes.

9. If, on the other hand, in the midst of difficulties we are always ready to seize an advantage, we may extricate ourselves from misfortune.

10. Reduce the hostile chiefs by inflicting damage on them; and make trouble for them, and keep them constantly engaged; hold out specious allurements, and make them rush to any given point.

11. The art of war teaches us to rely not on the likelihood of the enemy's not coming, but on our own readiness to receive him; not on the chance of his not attacking, but rather on the fact that we have made our position unassailable.

12. There are five dangerous faults which may affect a general: (1) Recklessness, which leads to destruction; (2) cowardice, which leads to capture; (3) a hasty temper, which can be provoked by insults; (4) a delicacy of honor which is sensitive to shame; (5) over-solicitude for his men, which exposes him to worry and trouble.

13. These are the five besetting sins of a general, ruinous to the conduct of war.

14. When an army is overthrown and its leader slain, the cause will surely be found among these five dangerous faults. Let them be a subject of meditation.

IX. The Army on the March

1. Sun Tzu said: We come now to the question of encamping the army, and observing signs of the enemy. Pass quickly over mountains, and keep in the neighborhood of valleys.

2. Camp in high places, facing the sun. Do not climb heights in order to fight. So much for mountain warfare.

3. After crossing a river, you should get far away from it.

4. When an invading force crosses a river in its onward march, do not advance to meet it in mid-stream. It will be best to let half the army get across, and then

deliver your attack.

5. If you are anxious to fight, you should not go to meet the invader near a river which he has to cross.

6. Moor your craft higher up than the enemy, and facing the sun. Do not move upstream to meet the enemy. So much for river warfare.

7. In crossing salt-marshes, your sole concern should be to get over them quickly, without any delay.

8. If forced to fight in a salt-marsh, you should have water and grass near you, and get your back to a clump of trees. So much for operations in salt-marches.

9. In dry, level country, take up an easily accessible position with rising ground to your right and on your rear, so that the danger may be in front, and safety lie behind. So much for campaigning in flat country.

10. These are the four useful branches of military knowledge which enabled the Yellow Emperor to vanquish four several sovereigns.

11. All armies prefer high ground to low and sunny places to dark.

12. If you are careful of your men, and camp on hard ground, the army will be free from disease of every kind, and this will spell victory.

13. When you come to a hill or a bank, occupy the sunny side, with the slope on your right rear. Thus you will at once act for the benefit of your soldiers and utilize the natural advantages of the ground.

14. When, in consequence of heavy rains up-country, a river which you wish to ford is swollen and flecked with foam, you must wait until it subsides.

15. Country in which there are precipitous cliffs with torrents running between, deep natural hollows, confined places, tangled thickets, quagmires and crevasses, should be left with all possible speed and not approached.

16. While we keep away from such places, we should get the enemy to approach them; while we face them, we should let the enemy have them on his rear.

17. If in the neighborhood of your camp there should be any hilly country, ponds surrounded by aquatic grass, hollow basins filled with reeds, or woods with thick undergrowth, they must be carefully routed out and searched; for these are places where men in ambush or insidious spies are likely to be lurking.

18. When the enemy is close at hand and remains quiet, he is relying on the natural strength of his position.

19. When he keeps aloof and tries to provoke a battle, he is anxious for the other side to advance.

20. If his place of encampment is easy of access, he is tendering a bait.

21. Movement amongst the trees of a forest shows that the enemy is advancing. The appearance of a number of screens in the midst of thick grass means that the enemy wants to make us suspicious.

22. The rising of birds in their flight is the sign of an ambush. Startled beasts indicate that a sudden attack is coming.

23. When there is dust rising in a high column, it is the sign of chariots advancing; when the dust is low, but spread over a wide area, it betokens the approach of infantry. When it branches out in different directions, it shows that parties have

been sent to collect firewood. A few clouds of dust moving to and fro signify that the army is encamping.

24. Humble words and increased preparations are signs that the enemy is about to advance. Violent language and driving forward as if to the attack are signs that he will retreat.

25. When the light chariots come out first and take up a position on the wings, it is a sign that the enemy is forming for battle.

26. Peace proposals unaccompanied by a sworn covenant indicate a plot.

27. When there is much running about and the soldiers fall into rank, it means that the critical moment has come.

28. When some are seen advancing and some retreating, it is a lure.

29. When the soldiers stand leaning on their spears, they are faint from want of food.

30. If those who are sent to draw water begin by drinking themselves, the army is suffering from thirst.

31. If the enemy sees an advantage to be gained and makes no effort to secure it, the soldiers are exhausted.

32. If birds gather on any spot, it is unoccupied. Clamor by night betokens nervousness.

33. If there is disturbance in the camp, the general's authority is weak. If the banners and flags are shifted about, sedition is afoot. If the officers are angry, it means that the men are weary.

34. When an army feeds its horses with grain and kills its cattle for food, and when the men do not hang their cooking-pots over the camp-fires, showing that they will not return to their tents, you may know that they are determined to fight to the death.

35. The sight of men whispering together in small knots or speaking in subdued tones points to disaffection amongst the rank and file.

36. Too frequent rewards signify that the enemy is at the end of his resources; too many punishments betray a condition of dire distress.

37. To begin by bluster, but afterwards to take fright at the enemy's numbers, shows a supreme lack of intelligence.

38. When envoys are sent with compliments in their mouths, it is a sign that the enemy wishes for a truce.

39. If the enemy's troops march up angrily and remain facing ours for a long time without either joining battle or taking themselves off again, the situation is one that demands great vigilance and circumspection.

40. If our troops are no more in number than the enemy, that is amply sufficient; it only means that no direct attack can be made. What we can do is simply to concentrate all our available strength, keep a close watch on the enemy, and obtain reinforcements.

41. He who exercises no forethought but makes light of his opponents is sure to be captured by them.

42. If soldiers are punished before they have grown attached to you, they will not

prove submissive; and, unless submissive, then will be practically useless. If, when the soldiers have become attached to you, punishments are not enforced, they will still be useless.

43. Therefore soldiers must be treated in the first instance with humanity, but kept under control by means of iron discipline. This is a certain road to victory.

44. If in training soldiers commands are habitually enforced, the army will be well-disciplined; if not, its discipline will be bad.

45. If a general shows confidence in his men but always insists on his orders being obeyed, the gain will be mutual.

X. Terrain

1. Sun Tzu said: We may distinguish six kinds of terrain, to wit: (1) Accessible ground; (2) entangling ground; (3) temporizing ground; (4) narrow passes; (5) precipitous heights; (6) positions at a great distance from the enemy.

2. Ground which can be freely traversed by both sides is called accessible.

3. With regard to ground of this nature, be before the enemy in occupying the raised and sunny spots, and carefully guard your line of supplies. Then you will be able to fight with advantage.

4. Ground which can be abandoned but is hard to re-occupy is called entangling.

5. From a position of this sort, if the enemy is unprepared, you may sally forth and defeat him. But if the enemy is prepared for your coming, and you fail to defeat him, then, return being impossible, disaster will ensue.

6. When the position is such that neither side will gain by making the first move, it is called temporizing ground.

7. In a position of this sort, even though the enemy should offer us an attractive bait, it will be advisable not to stir forth, but rather to retreat, thus enticing the enemy in his turn; then, when part of his army has come out, we may deliver our attack with advantage.

8. With regard to narrow passes, if you can occupy them first, let them be strongly garrisoned and await the advent of the enemy.

9. Should the army forestall you in occupying a pass, do not go after him if the pass is fully garrisoned, but only if it is weakly garrisoned.

10. With regard to precipitous heights, if you are beforehand with your adversary, you should occupy the raised and sunny spots, and there wait for him to come up.

11. If the enemy has occupied them before you, do not follow him, but retreat and try to entice him away.

12. If you are situated at a great distance from the enemy, and the strength of the two armies is equal, it is not easy to provoke a battle, and fighting will be to your disadvantage.

13. These six are the principles connected with Earth. The general who has attained a responsible post must be careful to study them.

14. Now an army is exposed to six several calamities, not arising from natural causes, but from faults for which the general is responsible. These are: (1) Flight; (2) insubordination; (3) collapse; (4) ruin; (5) disorganization; (6) rout.

15. Other conditions being equal, if one force is hurled against another ten times its size, the result will be the flight of the former.
16. When the common soldiers are too strong and their officers too weak, the result is insubordination. When the officers are too strong and the common soldiers too weak, the result is collapse.
17. When the higher officers are angry and insubordinate, and on meeting the enemy give battle on their own account from a feeling of resentment, before the commander-in-chief can tell whether or no he is in a position to fight, the result is ruin.
18. When the general is weak and without authority; when his orders are not clear and distinct; when there are no fixed duties assigned to officers and men, and the ranks are formed in a slovenly haphazard manner, the result is utter disorganization.
19. When a general, unable to estimate the enemy's strength, allows an inferior force to engage a larger one, or hurls a weak detachment against a powerful one, and neglects to place picked soldiers in the front rank, the result must be rout.
20. These are six ways of courting defeat, which must be carefully noted by the general who has attained a responsible post.
21. The natural formation of the country is the soldier's best ally; but a power of estimating the adversary, of controlling the forces of victory, and of shrewdly calculating difficulties, dangers and distances, constitutes the test of a great general.
22. He who knows these things, and in fighting puts his knowledge into practice, will win his battles. He who knows them not, nor practices them, will surely be defeated.
23. If fighting is sure to result in victory, then you must fight, even though the ruler forbid it; if fighting will not result in victory, then you must not fight even at the ruler's bidding.
24. The general who advances without coveting fame and retreats without fearing disgrace, whose only thought is to protect his country and do good service for his sovereign, is the jewel of the kingdom.
25. Regard your soldiers as your children, and they will follow you into the deepest valleys; look upon them as your own beloved sons, and they will stand by you even unto death.
26. If, however, you are indulgent, but unable to make your authority felt; kind-hearted, but unable to enforce your commands; and incapable, moreover, of quelling disorder: then your soldiers must be likened to spoilt children; they are useless for any practical purpose.
27. If we know that our own men are in a condition to attack, but are unaware that the enemy is not open to attack, we have gone only halfway towards victory.
28. If we know that the enemy is open to attack, but are unaware that our own men are not in a condition to attack, we have gone only halfway towards victory.
29. If we know that the enemy is open to attack, and also know that our men are in a condition to attack, but are unaware that the nature of the ground makes fighting

impracticable, we have still gone only halfway towards victory.

30. Hence the experienced soldier, once in motion, is never bewildered; once he has broken camp, he is never at a loss.

31. Hence the saying: If you know the enemy and know yourself, your victory will not stand in doubt; if you know Heaven and know Earth, you may make your victory complete.

XI. The Nine Situations

1. Sun Tzu said: The art of war recognizes nine varieties of ground: (1) Dispersive ground; (2) facile ground; (3) contentious ground; (4) open ground; (5) ground of intersecting highways; (6) serious ground; (7) difficult ground; (8) hemmed-in ground; (9) desperate ground.

2. When a chieftain is fighting in his own territory, it is dispersive ground.

3. When he has penetrated into hostile territory, but to no great distance, it is facile ground.

4. Ground the possession of which imports great advantage to either side, is contentious ground.

5. Ground on which each side has liberty of movement is open ground.

6. Ground which forms the key to three contiguous states, so that he who occupies it first has most of the Empire at his command, is a ground of intersecting highways.

7. When an army has penetrated into the heart of a hostile country, leaving a number of fortified cities in its rear, it is serious ground.

8. Mountain forests, rugged steeps, marshes and fens--all country that is hard to traverse: this is difficult ground.

9. Ground which is reached through narrow gorges, and from which we can only retire by tortuous paths, so that a small number of the enemy would suffice to crush a large body of our men: this is hemmed in ground.

10. Ground on which we can only be saved from destruction by fighting without delay, is desperate ground.

11. On dispersive ground, therefore, fight not. On facile ground, halt not. On contentious ground, attack not.

12. On open ground, do not try to block the enemy's way. On the ground of intersecting highways, join hands with your allies.

13. On serious ground, gather in plunder. In difficult ground, keep steadily on the march.

14. On hemmed-in ground, resort to stratagem. On desperate ground, fight.

15. Those who were called skillful leaders of old knew how to drive a wedge between the enemy's front and rear; to prevent co-operation between his large and small divisions; to hinder the good troops from rescuing the bad, the officers from rallying their men.

16. When the enemy's men were united, they managed to keep them in disorder.

17. When it was to their advantage, they made a forward move; when otherwise, they stopped still.

18. If asked how to cope with a great host of the enemy in orderly array and on the point of marching to the attack, I should say: "Begin by seizing something which your opponent holds dear; then he will be amenable to your will."

19. Rapidity is the essence of war: take advantage of the enemy's unreadiness, make your way by unexpected routes, and attack unguarded spots.

20. The following are the principles to be observed by an invading force: The further you penetrate into a country, the greater will be the solidarity of your troops, and thus the defenders will not prevail against you.

21. Make forays in fertile country in order to supply your army with food.

22. Carefully study the well-being of your men, and do not overtax them.

Concentrate your energy and hoard your strength. Keep your army continually on the move, and devise unfathomable plans.

23. Throw your soldiers into positions whence there is no escape, and they will prefer death to flight. If they will face death, there is nothing they may not achieve. Officers and men alike will put forth their uttermost strength.

24. Soldiers when in desperate straits lose the sense of fear. If there is no place of refuge, they will stand firm. If they are in hostile country, they will show a stubborn front. If there is no help for it, they will fight hard.

25. Thus, without waiting to be marshaled, the soldiers will be constantly on the qui vive; without waiting to be asked, they will do your will; without restrictions, they will be faithful; without giving orders, they can be trusted.

26. Prohibit the taking of omens, and do away with superstitious doubts. Then, until death itself comes, no calamity need be feared.

27. If our soldiers are not overburdened with money, it is not because they have a distaste for riches; if their lives are not unduly long, it is not because they are disinclined to longevity.

28. On the day they are ordered out to battle, your soldiers may weep, those sitting up bedewing their garments, and those lying down letting the tears run down their cheeks. But let them once be brought to bay, and they will display the courage of a Chu or a Kuei.

29. The skillful tactician may be likened to the shuai-jan. Now the shuai-jan is a snake that is found in the ChUng mountains. Strike at its head, and you will be attacked by its tail; strike at its tail, and you will be attacked by its head; strike at its middle, and you will be attacked by head and tail both.

30. Asked if an army can be made to imitate the shuai-jan, I should answer, Yes. For the men of Wu and the men of Yueh are enemies; yet if they are crossing a river in the same boat and are caught by a storm, they will come to each other's assistance just as the left hand helps the right.

31. Hence it is not enough to put one's trust in the tethering of horses, and the burying of chariot wheels in the ground

32. The principle on which to manage an army is to set up one standard of courage which all must reach.

33. How to make the best of both strong and weak--that is a question involving the proper use of ground.

34. Thus the skillful general conducts his army just as though he were leading a single man, willy-nilly, by the hand.
35. It is the business of a general to be quiet and thus ensure secrecy; upright and just, and thus maintain order.
36. He must be able to mystify his officers and men by false reports and appearances, and thus keep them in total ignorance.
37. By altering his arrangements and changing his plans, he keeps the enemy without definite knowledge. By shifting his camp and taking circuitous routes, he prevents the enemy from anticipating his purpose.
38. At the critical moment, the leader of an army acts like one who has climbed up a height and then kicks away the ladder behind him. He carries his men deep into hostile territory before he shows his hand.
39. He burns his boats and breaks his cooking-pots; like a shepherd driving a flock of sheep, he drives his men this way and that, and nothing knows whither he is going.
40. To muster his host and bring it into danger:--this may be termed the business of the general.
41. The different measures suited to the nine varieties of ground; the expediency of aggressive or defensive tactics; and the fundamental laws of human nature: these are things that must most certainly be studied.
42. When invading hostile territory, the general principle is, that penetrating deeply brings cohesion; penetrating but a short way means dispersion.
43. When you leave your own country behind, and take your army across neighborhood territory, you find yourself on critical ground. When there are means of communication on all four sides, the ground is one of intersecting highways.
44. When you penetrate deeply into a country, it is serious ground. When you penetrate but a little way, it is facile ground.
45. When you have the enemy's strongholds on your rear, and narrow passes in front, it is hemmed-in ground. When there is no place of refuge at all, it is desperate ground.
46. Therefore, on dispersive ground, I would inspire my men with unity of purpose. On facile ground, I would see that there is close connection between all parts of my army.
47. On contentious ground, I would hurry up my rear.
48. On open ground, I would keep a vigilant eye on my defenses. On ground of intersecting highways, I would consolidate my alliances.
49. On serious ground, I would try to ensure a continuous stream of supplies. On difficult ground, I would keep pushing on along the road.
50. On hemmed-in ground, I would block any way of retreat. On desperate ground, I would proclaim to my soldiers the hopelessness of saving their lives.
51. For it is the soldier's disposition to offer an obstinate resistance when surrounded, to fight hard when he cannot help himself, and to obey promptly when he has fallen into danger.

52. We cannot enter into alliance with neighboring princes until we are acquainted with their designs. We are not fit to lead an army on the march unless we are familiar with the face of the country--its mountains and forests, its pitfalls and precipices, its marshes and swamps. We shall be unable to turn natural advantages to account unless we make use of local guides.
53. To be ignored of any one of the following four or five principles does not befit a warlike prince.
54. When a warlike prince attacks a powerful state, his generalship shows itself in preventing the concentration of the enemy's forces. He overawes his opponents, and their allies are prevented from joining against him.
55. Hence he does not strive to ally himself with all and sundry, nor does he foster the power of other states. He carries out his own secret designs, keeping his antagonists in awe. Thus he is able to capture their cities and overthrow their kingdoms.
56. Bestow rewards without regard to rule, issue orders without regard to previous arrangements; and you will be able to handle a whole army as though you had to do with but a single man.
57. Confront your soldiers with the deed itself; never let them know your design. When the outlook is bright, bring it before their eyes; but tell them nothing when the situation is gloomy.
58. Place your army in deadly peril, and it will survive; plunge it into desperate straits, and it will come off in safety.
59. For it is precisely when a force has fallen into harm's way that is capable of striking a blow for victory.
60. Success in warfare is gained by carefully accommodating ourselves to the enemy's purpose.
61. By persistently hanging on the enemy's flank, we shall succeed in the long run in killing the commander-in-chief.
62. This is called ability to accomplish a thing by sheer cunning.
63. On the day that you take up your command, block the frontier passes, destroy the official tallies, and stop the passage of all emissaries.
64. Be stern in the council-chamber, so that you may control the situation.
65. If the enemy leaves a door open, you must rush in.
66. Forestall your opponent by seizing what he holds dear, and subtly contrive to time his arrival on the ground.
67. Walk in the path defined by rule, and accommodate yourself to the enemy until you can fight a decisive battle.
68. At first, then, exhibit the coyness of a maiden, until the enemy gives you an opening; afterwards emulate the rapidity of a running hare, and it will be too late for the enemy to oppose you.

XII. The Attack by Fire

1. Sun Tzu said: There are five ways of attacking with fire. The first is to burn soldiers in their camp; the second is to burn stores; the third is to burn baggage

trains; the fourth is to burn arsenals and magazines; the fifth is to hurl dropping fire amongst the enemy.

2. In order to carry out an attack, we must have means available. The material for raising fire should always be kept in readiness.

3. There is a proper season for making attacks with fire, and special days for starting a conflagration.

4. The proper season is when the weather is very dry; the special days are those when the moon is in the constellations of the Sieve, the Wall, the Wing or the Cross-bar; for these four are all days of rising wind.

5. In attacking with fire, one should be prepared to meet five possible developments:

6. (1) When fire breaks out inside to enemy's camp, respond at once with an attack from without.

7. (2) If there is an outbreak of fire, but the enemy's soldiers remain quiet, bide your time and do not attack.

8. (3) When the force of the flames has reached its height, follow it up with an attack, if that is practicable; if not, stay where you are.

9. (4) If it is possible to make an assault with fire from without, do not wait for it to break out within, but deliver your attack at a favorable moment.

10. (5) When you start a fire, be to windward of it. Do not attack from the leeward.

11. A wind that rises in the daytime lasts long, but a night breeze soon falls.

12. In every army, the five developments connected with fire must be known, the movements of the stars calculated, and a watch kept for the proper days.

13. Hence those who use fire as an aid to the attack show intelligence; those who use water as an aid to the attack gain an accession of strength.

14. By means of water, an enemy may be intercepted, but not robbed of all his belongings.

15. Unhappy is the fate of one who tries to win his battles and succeed in his attacks without cultivating the spirit of enterprise; for the result is waste of time and general stagnation.

16. Hence the saying: The enlightened ruler lays his plans well ahead; the good general cultivates his resources.

17. Move not unless you see an advantage; use not your troops unless there is something to be gained; fight not unless the position is critical.

18. No ruler should put troops into the field merely to gratify his own spleen; no general should fight a battle simply out of pique.

19. If it is to your advantage, make a forward move; if not, stay where you are.

20. Anger may in time change to gladness; vexation may be succeeded by content.

21. But a kingdom that has once been destroyed can never come again into being; nor can the dead ever be brought back to life.

22. Hence the enlightened ruler is heedful, and the good general full of caution.

This is the way to keep a country at peace and an army intact.

XIII. The Use of Spies

1. Sun Tzu said: Raising a host of a hundred thousand men and marching them great distances entails heavy loss on the people and a drain on the resources of the State. The daily expenditure will amount to a thousand ounces of silver. There will be commotion at home and abroad, and men will drop down exhausted on the highways. As many as seven hundred thousand families will be impeded in their labor.
2. Hostile armies may face each other for years, striving for the victory which is decided in a single day. This being so, to remain in ignorance of the enemy's condition simply because one grudges the outlay of a hundred ounces of silver in honors and emoluments, is the height of inhumanity.
3. One who acts thus is no leader of men, no present help to his sovereign, no master of victory.
4. Thus, what enables the wise sovereign and the good general to strike and conquer, and achieve things beyond the reach of ordinary men, is foreknowledge.
5. Now this foreknowledge cannot be elicited from spirits; it cannot be obtained inductively from experience, nor by any deductive calculation.
6. Knowledge of the enemy's dispositions can only be obtained from other men.
7. Hence the use of spies, of whom there are five classes: (1) Local spies; (2) inward spies; (3) converted spies; (4) doomed spies; (5) surviving spies.
8. When these five kinds of spy are all at work, none can discover the secret system. This is called "divine manipulation of the threads." It is the sovereign's most precious faculty.
9. Having local spies means employing the services of the inhabitants of a district.
10. Having inward spies, making use of officials of the enemy.
11. Having converted spies, getting hold of the enemy's spies and using them for our own purposes.
12. Having doomed spies, doing certain things openly for purposes of deception, and allowing our spies to know of them and report them to the enemy.
13. Surviving spies, finally, are those who bring back news from the enemy's camp.
14. Hence it is that which none in the whole army are more intimate relations to be maintained than with spies. None should be more liberally rewarded. In no other business should greater secrecy be preserved.
15. Spies cannot be usefully employed without a certain intuitive sagacity.
16. They cannot be properly managed without benevolence and straightforwardness.
17. Without subtle ingenuity of mind, one cannot make certain of the truth of their reports.
18. Be subtle! be subtle! and use your spies for every kind of business.
19. If a secret piece of news is divulged by a spy before the time is ripe, he must be put to death together with the man to whom the secret was told.
20. Whether the object be to crush an army, to storm a city, or to assassinate an individual, it is always necessary to begin by finding out the names of the attendants, the aides-de-camp, and door-keepers and sentries of the general in

command. Our spies must be commissioned to ascertain these.

21. The enemy's spies who have come to spy on us must be sought out, tempted with bribes, led away and comfortably housed. Thus they will become converted spies and available for our service.

22. It is through the information brought by the converted spy that we are able to acquire and employ local and inward spies.

23. It is owing to his information, again, that we can cause the doomed spy to carry false tidings to the enemy.

24. Lastly, it is by his information that the surviving spy can be used on appointed occasions.

25. The end and aim of spying in all its five varieties is knowledge of the enemy; and this knowledge can only be derived, in the first instance, from the converted spy. Hence it is essential that the converted spy be treated with the utmost liberality.

26. Of old, the rise of the Yin dynasty was due to I Chih who had served under the Hsia. Likewise, the rise of the Chou dynasty was due to Lu Ya who had served under the Yin.

27. Hence it is only the enlightened ruler and the wise general who will use the highest intelligence of the army for purposes of spying and thereby they achieve great results. Spies are a most important element in war, because on them depends an army's ability to move.

XVIII. Booby Traps

As mentioned earlier, booby traps are explained in detail by Ragnar Benson in his two books: *Mantrapping* and *Big Book of Homemade Weapons*. Here a brief summary is provided.

Having various types of camouflaged booby traps placed alongside approach avenues can also net extra enemy casualties. Wait until the attackers are alongside the booby traps, then fire at them, forcing them to jump for safety — onto the booby traps.

In addition to the various grenade and mine-style booby traps mentioned elsewhere in this book, it's profitable to fabricate booby traps of readily available materials. These will often cause only minor wounds, but that may be disconcerting enough to an attacker to cause him to become less aggressive as he realizes that he can be injured — or killed.

If you have fishing gear, very vicious little snares can be created by stringing fish hooks at face level; these won't do much damage but can unnerve troops encountering them. Boards with long nails driven through them, and the point side left up, can be covered with a thin layer of sod and the grass watered so it grows to conceal the spikes. Bottles or jars with their mouths broken off can be concealed in grass and rubble as easily.

A sort of mini-land mine can be created with a cartridge that fits into a piece of iron — or even heavy plastic — pipe. Make a fixed firing pin in the exact center of the tubing (you can use a pipe fitting or wooden base to hold the firing pin in place). A wooden plug can be placed over the bullet end of the cartridge. This should be positioned so it will shove the cartridge back toward the fixed pin. This "mine" should be buried so the plug is sticking up, waiting for a soldier to step on it. When he tramps on it, the plug squashes the cartridge into the firing pin, the cartridge explodes, and the soldier's foot is injured.

The wound won't be too serious; most combat boots will protect a foot UNLESS you're using a large shotgun cartridge or similar shell. But the mini-mine is disconcerting and will sound an alert of enemy approach. Of course damage can be significant if you've rigged a .50 caliber machine gun cartridge or similar "biggie." It would also be possible to rig up these mini-mines to do some serious damage by using such a device to fire a secondary explosion or trigger an artillery shell or mortar. (These would take some real know-how to set up — don't fool with them if you're uncertain about what you're

doing.)

Punjii sticks normally have both ends sharpened so that they can be quickly pushed into the earth. The pointed end remains up to impale your antagonists. Whittling the points is labor intensive and there are quicker ways to create the sticks. They can be cut quickly if you're in a region with any type of brush or trees and have pruning "lop-pers" available.

Loppers enable you to cut sticks very quickly by sheering the sticks off at a sharp angle. The punjii sticks can be made as fast as you can snap them off and gather them up. "Urban punjii sticks" can be created by cutting copper or aluminum tubing, conduits, or TV antennas at a sharp angle.

Punjii sticks can be planted in shallow ponds below water level, used in pits which have a light covering (through which a soldier falls when he steps onto it), or concealed in tall grass or under plastic sheets or other thin rubble. It is also possible to fasten punjii sticks to heavy weights and hang them point down over areas where the enemy may be. Using trip wires, or similar devices, will release them to drop on your foes. The sticks can also create some "stand off" distance in front of moveable barricades in tunnels or hallways. Such barriers can seal off your fighters' retreat if positions need to be abandoned when they are overrun.

There are a wealth of other booby traps that can be created by an enterprising freedom fighter. Try to take advantage of the materials at hand and keep things simple or they're apt to fail or will be dangerous and time-consuming to construct. (For a detailed look at snares and various traps designed for use against human beings, see Ragnar Benson's MANTRAPPING which is available from Paladin Press, P. O. Box 1307, Boulder, CO 80306 800-392-2400 for \$12.)

If you're in a hilly or urban district, falling rocks or rubble can create casualties. In fact, one partisan dropping stones might be as effective as a machine gunner, if he is strategically placed with a ready "armament" of loose boulders.

XIX. Body Armour

- Soft armor (whether soft plates or soft vests) is only for knives, pistols, and shotguns. We mostly ignore this type, although it can be good for light and stealthy mild protection.
- We want to protect against rifles, too. This means you buy hard armor that you insert into a chest harness (usually called a plate carrier).
- All armor is rated by level. The higher the level, the more types of ammo it protects against. All soft armor is level IIIa (i.e. “3 minus”) or below, and all hard armor is III, III+, or IV.
- Level III is not good enough because it can’t stop common AR-15 rifle rounds.
- Level III+ is the sweet spot for most people. Level IV is for serious fighters.
- Choosing body armor is about compromise and trade offs, such as protection vs. cost vs. weight vs. thickness.
- When evaluating armor, it’s not good enough to say things like, “this armor beats .223 ammo!” It depends entirely on the specific ammunition used, including how fast the bullet travels. We focus on M855 and M193 .223 ammo as the criteria for level III+.
- Hard body armor is heavier and more uncomfortable than you expect.
- The vast majority of people prefer curved plates instead of flat plates.
- Weight matters more than most people expect. The difference between 18 pounds and 11 pounds of armor is meaningful for untrained civilians in emergency scenarios.
- Full body armor is not worth it. Adding a helmet or side plates is fine, but many soldiers are going in the opposite direction, reducing their coverage area in order to be more nimble and comfortable.
- Never use steel armor without an anti-spall coating.
- Ceramic armor does not take as many hits and is not as durable as steel armor, but it’s not the fragile porcelain some make it out to be.

Some strong commercial brands: HighCom Guardian 4S17M IV, DFNDR IV, Hesco 4600 and RMA 1155 (via AR500 IV).

Insane strength: Kryron body armor can stop .50 cal shots from 50 feet. It uses a special aluminium alloy and carbon nanotubes.

DIY Body Armour

Your life is in your hands: research strong materials and test a sample of your armour before heading into combat. The process below also works for making helmets and protecting other areas of the body, though make sure you are nimble enough to carry out your mission.

Materials:

- 1) Ceramic Floor Tile (PEI5)
- 2) Medium Weight Denim
- 3) Construction Adhesive
- 4) Galvanized sheet metal (used for roof flashing)

Step 1: Cut the Denim to size. A 6" x 6" Tile will require a piece of denim that is 19" x 19". The extra one inch comes from the excess material required to account for the folding of the denim.

Step 2: Add the Construction Adhesive. Use a putty knife to spread out the liquid nails or construction adhesive and push it into the fabric.

Step 3: Place a PEI 5 Ceramic Tile in the center of the denim fabric.

Step 4: Continue to add construction adhesive to the denim and fold it onto itself. The final plate will have one layer in front of the ceramic tile, and 8 layers of construction adhesive on the back.

Step 5:

Attach the sheet metal to the back of the plate.



Fig. 192. Brewster body armor, 1917-1918

XX. The Enemy – Targets and Background

Generally speaking our primary enemy is the jewish menace. Kikes are behind most of the cultural marxism, degeneracy, censorship and general evil in this world. It is assumed that you have basic background knowledge about the Zionist Occupational Government and the post-WW2 New World Order. If not just head to your local /pol/ and ask for redpills on the jews.

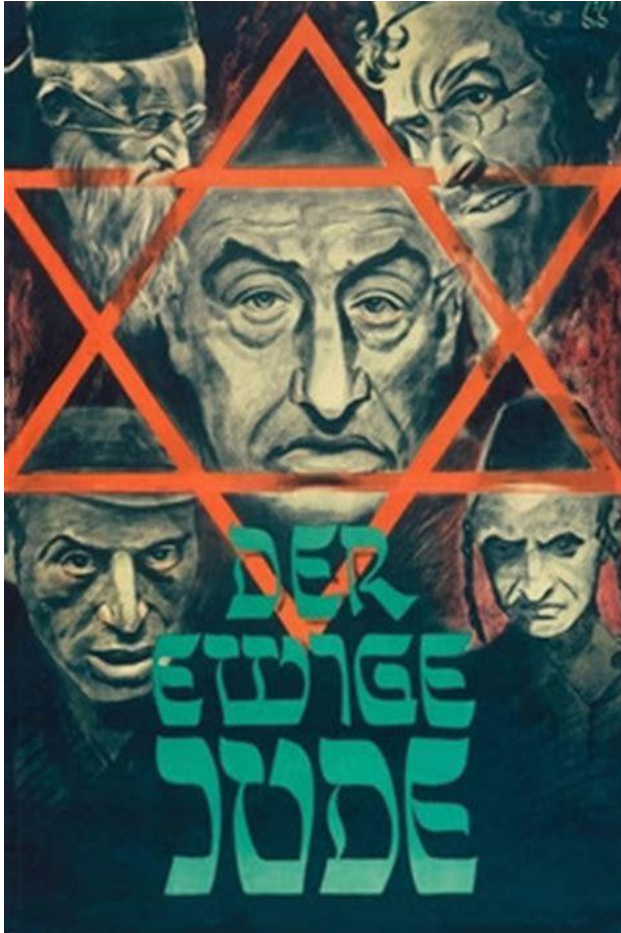

Aim for the synagogues. Aim for their homes. Target their businesses. Drive them OUT of our countries! The jew vermin must be expunged from our societies for ever. Show no mercy.

Globalists, Marxists, other races

Our secondary priority are globalists, marxists and foreign invaders who pollute our nation and race. Ideally, we want to convert those of our race to National Socialism.



Aim for diversity pushing NGOs and businesses, aim for illegal immigrants, aim for politicians who push looser immigration laws, aim for race mixers and traitors, aim for LGBTQueers, aim for marxist professors and other people in positions of power.

Crush degeneracy. Purge the unrepentant. Restore law and order. Save traditionalism. Build your nation. Purify your race.



XXI. Bibliography and Resources



Waging Modern War: Bosnia, Kosovo and the Future of Combat,
General Wesley K. Clark. ISBN: 158648043X

The Turner Diaries, Andrew Macdonald (William Pierce) Available free
online.

The Last Hundred Yards : The NCO's Contribution to Warfare, H.J.
Poole. ISBN: 0963869523

Field Manual 7-90, Tactical Employment of Mortars, U.S. Army

Jane's Ammunition Handbook 2008-2009 Edited by Leland Ness and

Anthony GWilliams, Seventeenth Edition. ISBN 978 07106 2838 1

FM 23-10 Sniper

FM 21-75 Soldier Skills

FM 23-23 Claymore

FM 23-30 Grenades

FM 90-10-1 Urban Combat Operations

FM 23-23 Claymore

FM 100-25 Doctrine For Army Special Operations Forces

FM 3-05.20 Special Forces Operations

FM 31-21 Special Forces Operations

TC 31-29 Special Forces Operational Techniques

FM 90-10-1, An Infantryman's Guide to Combat in Built-Up Areas

FM 31-20 Doctrine for Special Forces Operations

Jay Mallin's Terror and Urban Guerrillas: A Study of Tactics and Documents

The Handbook for Volunteers of the Irish Republican Army: Notes on Guerrilla Warfare by IRA General Headquarters

Books from Joint Special Operations University Press

The Other Side of the Mountain: Mujahideen Tactics in the Soviet-Afghan War by Lester Grau

The Caucasus Conflict and Russian Security: The Russian Armed Forces Confront Chechnya, Parts One, Two, and Three by Timothy Thomas

The Battle of Grozny: Deadly Classroom for Urban Combat by Timothy Thomas

Grozny 2000: Urban Combat Lessons Learned by Timothy Thomas

Chechnya: Urban Warfare Lessons Learned by Arthur L. Speyer, III of the Marine Corps Intelligence Activity

Books by Duncan Long

150 Questions for a Guerrilla by Alberto Bayo

The Culture of Critique by Kevin MacDonald -
<http://www.angelfire.com/rebellion2/goyim/je1.pdf>

Understanding Jewish Influence I: Background Traits for Jewish
Activism - <http://www.kevinmacdonald.net/UnderstandJI-1.htm>

Understanding Jewish Influence II: Zionism and the Internal Dynamics
of Judaism - <http://www.kevinmacdonald.net/UnderstandJI-2.htm>

Understanding Jewish Influence III: Neoconservatism as a Jewish
Movement - <http://www.kevinmacdonald.net/UnderstandJI-3.htm>

Jewish Involvement in Shaping American Immigration Policy, 1881-
1965: A Historical Review - <http://www.kevinmacdonald.net/books-immigration.html>

Jews, Blacks, and Race -
<http://www.kevinmacdonald.net/Jews&Blacks.pdf>

The Israel Lobby: A Case Study in Jewish Influence -
<http://www.kevinmacdonald.net/M&WReview.pdf>

Stalin's Willing Executioners: Jews as a Hostile Elite in the USSR -
<http://www.kevinmacdonald.net/SlezkineRev.pdf>

Poor man's James bond

Anarchist cookbook

Principles of Improvised Explosive Devices

FM 5-20 Camouflage

Complete guide to lock picking

Get Even I and II

TM 31-200-1 Unconventional warfare devices

TM 31-201-1 Unconventional warfare references

Grandads Book of Chemistry

FM 3-50-1 Deliberate Smoke Operations

FM 23-30 Grenades and Pyrotechnics

ST 21-75-3 Dismounted Patrolling

FM 5-15 Field Fortifications

FM 21-15 Care and Use of Equipment

FM 20-3 Camouflage

FM 24-1 Combat Communications

TM 31-210 Improvised Munitions

FM 90-10 Infantryman's Guide to Urban Combat

FM 21-76 Survival

War at Home, Cover Action Against U.S. Activists And What We Can Do About It by Brian Glick

U.S. Navy Seal Manual

Improvised Munition Systems

Special Forces Handbook

Special Forces Operational Techniques

Anarchist HANDBOOK

Weaponer - Kurt Saxon

Improvised Weapons of Modern Ninja

Loompanics Unlimited Main Catalog

GREEN PANTHERS! Action/Survival Manual

<https://archive.org/details/SamCulperSecurityAResistanceManual>

<https://archive.org/details/EcoDefenseAFieldGuideToMonkeywrenching>

"4th Generation Warfare Handbook" by William Lind

<https://www.stormfront.org/forum/t3014-21/>

http://cdn.preterhuman.net/texts/terrorism_and_pyrotechnics

<https://bulletpicker.com/pdf/FM%203-23.30,%20Grenades%20and%20Pyrotechnic%20Signals.pdf>

https://archive.org/details/Inspire_201707

https://projects.nfstc.org/firearms/module05/fir_m05.htm

https://www.chuckhawks.com/cartridge_case.htm

<https://publicintelligence.net/>

<https://publicintelligence.net/awg-urban-warfare/>

<https://publicintelligence.net/bja-digital-footprints/>

<https://publicintelligence.net/dhs-facilities-guidelines-emp/>

<https://publicintelligence.net/nvric-social-media-public-safety/>

<https://www.pssurvival.com/>

<https://www.stormfront.org/forum/t3014-21/>

<https://archive.org/details/TheNatureOfZionism1993-VladimirStepin>

<https://archive.org/details/OttoSkorzenyMyCommandoOperations>

<https://archive.org/details/EcoDefenseAFieldGuideToMonkeywrenching/page/n9>

<https://archive.org/details/FaithAndAction>

<https://archive.org/details/artworldlywisdom00grac/page/n67>

<http://mountainguerrilla.wordpress.com/>

<http://thelizardfarmer.wordpress.com/>

<https://westernrifleshooters.wordpress.com/>

<https://bastionofliberty.blogspot.com/>

<http://coldfury.com/>

<https://thesilicongraybeard.blogspot.com/>

<http://www.woodpilereport.com/>

