

# MANTRAPPING

By Ragnar Benson

Illustrations by J. Wilson

Paladin Press  
Boulder, Colorado

## Contents

Introduction .....	1
1. Philosophy .....	5
2. Triggers .....	11
3. Pit Trap .....	23
4. Sheepeaters' Rockfall.....	29
5. Malaysian Hawk .....	35
6. Chinese Chopper .....	39
7. Cuban Water Trap .....	45
8. Andes Mountain Trail Trap .....	51
9. Spike Trap .....	55
10. Jungle Snare .....	61
11. Jivaro Catapult.....	65
12. Jack the Tank Killer .....	71
13. Benson's Log Snare .....	77
Conclusion .....	83

## Introduction

Without question, man can be the most difficult animal on earth to trap. Humans are certainly more intelligent than any other creature. Except in rare instances, however, they do not possess the individual sensory keenness that other species of mammals do. Yet man's collective senses—good sight, excellent perception of color and depth, some sense of smell, adequate hearing, and reasonable taste—provide him with an edge that is superior to species having one or, at the most, two, very well developed sensory mechanisms.

A cage-raised mink that inadvertently finds its way to freedom is extremely easy to trap. Not so with its wild cousin who can be as wily and cunning as any animal in North America.

Societies that still practice mantrapping tend to live close to the earth. For them, it is natural to progress from trapping small and big game, to protecting their home territory with mantraps.

Americans and members of other urbanized civilizations have not fared very well on a one-to-one basis against societies that have attempted to mantrap them. But, because subsistence tribes tend to be small, suffering mightily from a high infant mortality rate, they have never posed much of a total threat to civilizations like ours.

People using primitive tools and materials might be able to trap several members of one patrol. Yet to continue to do so on a regular basis would, in most cases, be beyond their capacity. A modern army, ignoring the few casualties it sustained, would send in yet larger, more mechanized forces until their primitive adversaries were overwhelmed by sheer numbers and attrition.

This is not to say that the havoc such resistance might create would not be individually lethal. The force a mantrap exhibits can indeed be deadly, particularly in a psychological sense.

Today, mantrapping naturally has evolved into the science of booby-trapping. Modern booby-trappers use explosives, complex electronic devices, and space-age fabrication processes to produce contrivances that, when left secretly behind, will kill or maim the enemy.

Many texts and military manuals have been written about booby-trapping. An especially great proliferation of these books occurred after the U.S. Vietnam experience.

Booby traps are *not* what this book is about.

Rather, it is about constructing primitive mantrapping devices using only hand saws, axes, shovels, rope or wire, and knives. The assumption throughout this book is that the reader will not have explosives, detonating devices, flammable liquids, manufactured chemicals or any other modern instrument of war at his disposal. Nor will I assume the tools available to you be any more sophisticated than a chain saw which, of course, could be replaced by a hand saw or axe.

There are a number of reasons for sticking exclusively with primitive-type traps. Anybody who wants information about modern booby traps can get it out of any number of easily obtained texts on the subject.

Perhaps most importantly, to know how to set a

trap for your enemy is also to know how to avoid being trapped yourself.

Mantrapping, which is almost always defensive in nature, can doubtlessly be used to help win wars. Where the terrain is rugged enough and the country expansive, traps can be set that so demoralize the attackers they will come to the conclusion that the game is not worth the candle. For years the Jivaros of the upper Amazon River basin successfully used traps as part of their defense against European intrusion. Fidel Castro killed Batista soldiers in mantraps, and the early Indians of North America often set traps for one another. Currently, Afghanistan rebels and guerrilla fighters are using rock traps in the mountains to trap Soviet tanks and other armor. For a clarification of the system used by the Afghani rebels, see chapter 12, "Jack the Tank Killer."

The mantrapping sets described in this book are typical, and are based on actual systems that I have personally encountered while traveling the world on special assignments over the past thirty years. In field use, these mantraps *do* work. In fact, it has been my sad misfortune to lose a number of close associates to these deadly efficient—however crude—devices. Put another way, they do an excellent job of separating the ranch minks from the wild ones.

I also feel that this work should be of interest to anthropologists and historians. For though mantraps have played an important role in many primitive societies, they have never been thoroughly discussed in any other book. Since many of these tribes are dying out, this information may well have passed into oblivion if I had not written *Mantrapping*.

During the last fifty years, Americans have pretty well forgotten the art of trapping in general. Many

otherwise astute military people have little idea that devices such as mantraps are still around. To some extent, the use of booby traps in southeast Asia changed this. Yet for the most part, the average modern soldier is ill prepared for a falling log or rolling stone. Obscurity notwithstanding, these are good reasons for the truly prepared freedom fighter to study mantrapping. This book covers many of the best devices. Hopefully it will help you be prepared when the time comes. If nothing else, it should keep your own ass out of someone else's sling.

## 1. Philosophy

A good trapper is a shrewd outdoorsman who has an eye for detail. A successful mantrapper is an incredibly shrewd outdoorsman who notices *every* detail around him.

I remember well my days tracking and then trapping men on the east coast of Africa. We used Somali trackers, exclusively. These people's perception of detail was, and I believe still is, the best in the world. Time after time I was totally awed by the accurate description they gave me of the number, age, and strength of forces they evaluated on the basis of tracks in the bush that *I couldn't even see*.

The final conclusive argument in favor of these people being the best there is came one day when my interpreter drew me into a discussion about trees. We were to travel south by foot for about thirty kilometers where we were to meet a second group at a prespecified baobab tree. To my amazement, I learned that the Somalis have more than a dozen words just to describe the *shape* of baobabs. It was very possible and quite common for them to describe an individual tree so exactly that a person who had never seen it before could walk right to the exact tree thirty kilometers away, just as though the trunk had a sign on it!

That is what I call perception of detail. Americans

don't even have the linguistic ability to accomplish this, much less the mentality that would allow such a thing in their culture.

Traps set for people must be made in harmony with the surrounding country, maintaining a complete paranoid emphasis on detail.

The trap has to fit the place in which it is constructed. If one is going to roll logs down a hill, there have to be logs occurring naturally in the immediate area. Do not plan on bringing in bushels of stones, for instance, where none exist, or digging pits in swamps or on the tops of rocky mountains.

All existing cover must be utilized. Pay attention to the kinds of brush and grass that are native to the immediate area. What is the color of the subsoil? Do not attempt to use a limb to hide a rope that is from a tree of a variety that does not grow within 100 meters of the set.

Dead grass is a dead giveaway, if there is no other like it within sight. Dried and withered branches are also taboo.

When setting any trap, all of the surrounding area must be altered as little as possible. Many times this will entail constructing the principal parts of the device far from the place of use. Dirt, sticks, and rocks that are turned up in the process of placing the trap must be moved far away; and hidden.

Usually the terrain is such that virtually all of this work has to be accomplished using muscle power. Construction of mantraps is not usually speeded up materially by adding additional people to the work crew. In most cases, there are a limited number of people who can do this type of labor. Even if more people are available, they begin to stumble over each other, creating so much extraneous sign that the set is ruined.



If you have an abundance of good people, split them into two or three crews and build at different locations. Just be sure there is good communication between the various parties, or you may start stumbling into each other's traps. At other times, materials may be at such a premium the use of more than one crew is impossible.

When the set is completed, it has to look natural. That means no foreign construction materials, no unusual ground or foliage disruption, no sawdust, chips, freshly scraped rocks, or bad smells. In other words, nothing can be out of place when you are finished.

If there were tracks on the path in the dust before the trap was placed, there will have to be tracks on the path after it is there. If there were leaves, there will have to be leaves, and so on.

Sometimes the solution to this problem can be very clever. I have seen Somali warriors whittle logs down to duplicate animal tracks and put them on poles that they "walked" through a finished set. The tracks looked very natural on the trail, leading the victim into the trap too far to be saved.

Another similar technique is to put animal feet on poles and run a set of animal tracks through the trap area. Good scouts know that in many cases wild animals are more cautious about where they walk than people are.

Many traps are made best by using wire, rope and nails. All of these marks of civilization must be covered by mud, brush, water, grass, leaves, or limbs.

Do not leave newly chopped logs, freshly dug earth, newly split rocks, or any other signs of recent activity around, even if it is far from the set. Shrewd scouts will know what these discarded materials are for, and will be doubly alert.

Be very cautious about making noise while preparing

a set. At times I have had a chain saw available, but didn't use it because of noise. It might have caused people on the trail or in villages in the vicinity to take note of what was happening. Don't forget, mantraps are usually defensive in nature. As a rule, they have to be set on home territory. When operating with closely knit, tight-mouthed partisans who hate the intended quarry, one can work openly and without concern. Otherwise, use a great deal of caution and stealth.

In this regard it is imperative that you not catch the wrong game. Nothing sours the attitude of villagers you are trying to protect more than having one of their children impaled on a torqued spike trap. At a minimum, friendly natives in the vicinity must be warned that the traps exist. At best, the people should be shown exactly what has been prepared, and where.

Sometimes it is possible to work out a meaningless little signal to warn away the people you are trying to protect. A handful of leaves in the path, a small hanging vine or some other item may be used. Generally people you will be working with will be astute enough to spot traps and avoid them if they know they are there. The only real danger is to small children, who sometimes range an incredible distance from their villages.

At times, traps can be set beyond one's safe territory. *Safe territory* is defined as being country where the enemy may come in to patrol infrequently, but never stays for very long. Mantraps set inside the enemy's lines have a limited harassing effect. The negative is that the set-up operations tend to be so dangerous the results are hardly ever worth the risk.

Obviously, mantrapping does not work in a combat zone. It is foolish to contemplate any significant military objectives by these means. But in the rear areas

where the traps can be set at one's good pleasure, they can be individually devastating, especially against city soldiers.

## 2. Triggers

The heart of any trapping system is the trigger. Without a simple, foolproof trigger to release the stored energy that the mantrap contains, other elaborate preparations are a foolish waste of time.

A trigger used to control a mantrap must be able to withstand just about anything Mother Nature is likely to throw at it. Really good triggers always have that characteristic. Neither rain, snow, mud, or heat should affect a good design, so care must be taken to provide protection for the trigger against the elements.

As with everything else in this business, good common sense helps immeasurably when selecting or developing a trigger.

At times it will seem virtually impossible to come up with any kind of credible trap/trigger combination. The trap itself may be one that can be hidden, but the correct materials for the trigger may not be on hand. Or the trigger may not lend itself to the application you have in mind. Sometimes the people you want to catch may be tipped off if they glimpse even a trigger or, for that matter, the entire set of terrain characteristics that go along with a trigger and mantrap.

My advice is to continue to work patiently on these sorts of problems, and tough it out. Blend your experience with local culture and in turn with available tech-

nology. Eventually an approach will evolve that will work very nicely; at least it always has for me.

If you become involved in mantrapping and if you are good at it, you will begin to develop unique traps of your own invention. The trigger systems I list here are basic, simple designs that can be used in many applications. As you begin to invent triggers yourself, keep in mind that they must meet the following basic criteria. A trigger must:

- A. Be simple.
- B. Be absolutely foolproof.
- C. Not be affected by the normal range of weather one might expect.
- D. Be made of common, easily obtained materials.
- E. Be easily hidden.
- F. Not contain an inherent set of characteristics that will immediately tip-off the subject you are trying to trap.

People who are pragmatically familiar with the outdoors and who have run a trap line for small or large game will not have to be reminded of the above points. Others need to remember to use a large enough trigger for the trap you envision being sprung.

One not at all well known concept is that of using a double trigger. This involves the principle of tripping a smaller trigger that in turn activates a main trigger which, in turn, is holding back a pile of rocks or stack of logs. Many times this system can be comprised of two triggers that are identical in design. An example here is a small figure four trigger that trips, allowing a log to fall, tripping a large figure four trigger holding back a big load of rocks.

A falling rock double trigger may be easier to conceptualize. Here a rock is set on the very edge of

a steep path. When nudged by a passing patrol leader, it rolls downhill. A buried wire line leading from the rock to a trigger under a massive log deck then tightens, tripping the trigger. The result is a cascade of falling logs, and hopefully a smashed patrol.

Keep the double trigger concept in mind. Often it is the key to dropping half a mountain on an adversary (or some similarly drastic event) that could not otherwise be accomplished with only a single trigger.

The figure four is the oldest, most reliable release mechanism in existence. North American Indians used it to trigger their deadfalls. Rendille and Samburo natives around Lake Rudolph in Africa still use it today.

Generally a figure four trigger will work wherever the trap consists of a load held up by an angled support. It is simple and effective. The device is not easily affected by the weather. No matter where one is in the world, there are usually readily available materials with which to build a figure four.

Describing a figure four trigger is needlessly difficult. There just is not that much mystery to them. Take a look at the drawing on the opposite page. It is much easier to understand than trying to follow a complicated word description.

When making a figure four, be sure the bait stick is long and dry. All of the pieces should be made of well-seasoned material that won't warp, shrink, or soften during the useful life of the trap.

The horizontal piece is especially crucial. A long, light member is easiest to dislodge. Those unfamiliar with traps will be amazed at how much energy can be contained by these few, relatively small sticks.

FIGURE 4  
TRIGGER

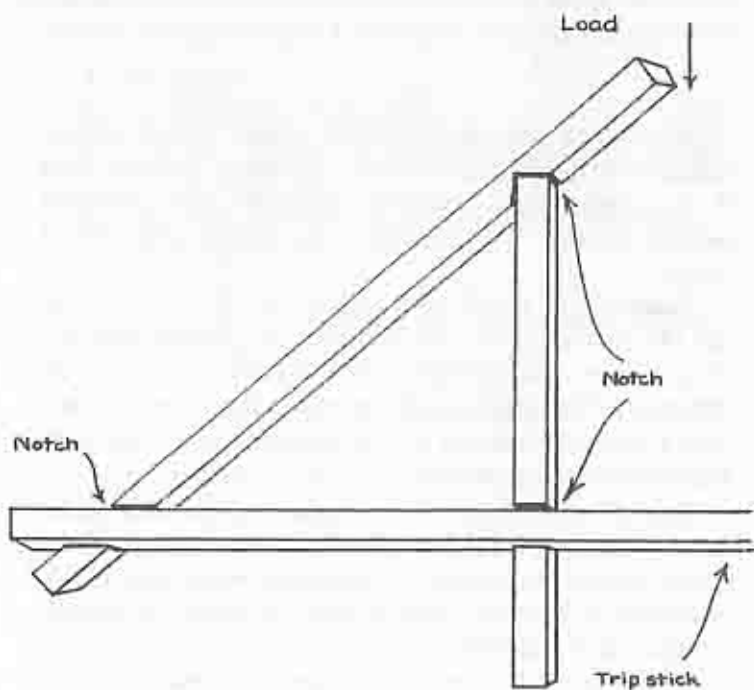

As you become proficient at mantrapping, other triggers will come to mind. Measure their effectiveness against a figure four, especially in the area of jamming. Nothing is so maddening as having pieces of the trigger hang up, keeping the trap unsprung when it should slam into action. I have had this happen without the enemy ever knowing they were in my trap. But usually they end up seeing the set, and are doubly wary from then on.

Many potentially good triggers are too slow on the uptake to be of much value. As a result, the quarry may walk past the impact area before there is any trap movement. Not only will he not be trapped, but the trap may be so slow in activating that the victim may never know he was a target.

Most trip stick triggers suffer from these sorts of limitations. The one I like is somewhat more reliable, but is still slow. Yet mantrappers need a trigger of this type in their repertoire. Mine is, as far as I know, about the best of the lot. If necessary, one can make up for any inherent slowness by having the load drop ahead on the path a few meters.

On the plus side, the trigger will work either horizontally or vertically, and it will contain a tremendous stack of logs, a huge bent tree, or a mountain of rocks.

The basic parts of this trigger are a pivot pole, a post, a pivot stick with rope to the trap, and a trip stick.

Notice from the accompanying drawing that the pivot pole is set up on a constructed post. This is not always necessary or wise. Often I have used the limb of a tree for a pivot pole. Similarly the post can be a naturally occurring tree. In fact, it is better if it is. The set will certainly look more natural. As with any trap, the



trick is to develop an eye for the really good places where traps can be built that blend well into the surroundings.

As shown in the diagram, the trip stick is above the ground in what seems like an exposed, obvious position. Many times the trip stick can be hidden or camouflaged. Inexperienced city troops will walk right into it anyway, covered or uncovered. Trapping them is like trapping marten. If you leave the trap uncovered, they seem to find it easier.

A very nice derivative of the exposed trip stick can be made by shallow burial of the trip in the ground on top of light filler, such as leaves or thistledown. The trigger must be minutely adjusted to work properly, which is not particularly difficult with this type of trigger.

Notice that the pivot stick can be obvious as it swings. Should this seem like a problem, build the set so the pivot stick is off the path several feet, screened by brush. By the time the quarry figures out what is happening, it is too late.

Trip stick triggers can be traps in and of themselves. I ran into several in Cuba years ago. The first one tripped when I hit some foliage with a machete. It swung a tremendous blow with its pivot stick that went low under my arm. We tripped the second with a pole. Both were much like the standard Jivaro traps described in chapter 11.

As a general rule, most snares operate with a trigger using the peg and nail concept. It's a good, simple device for this type of trigger setup.

With only a modest amount of tinkering, the trigger can be made to hold back a man-whomping load. Yet it

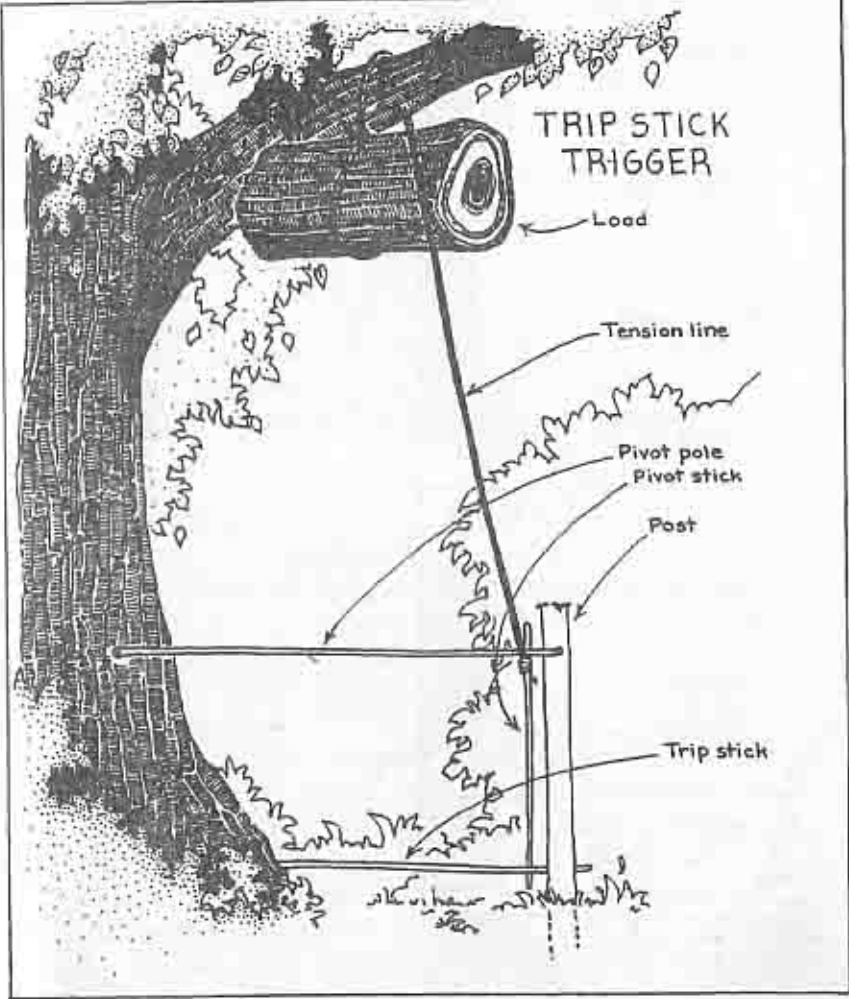

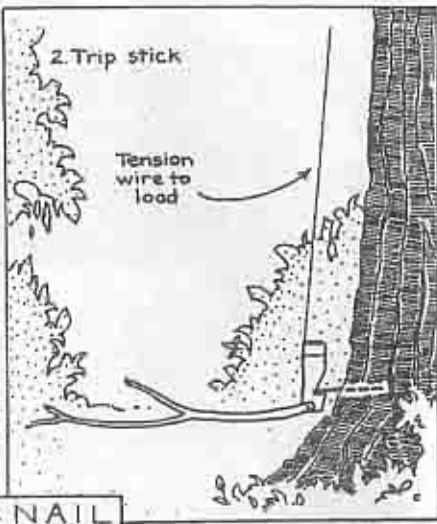
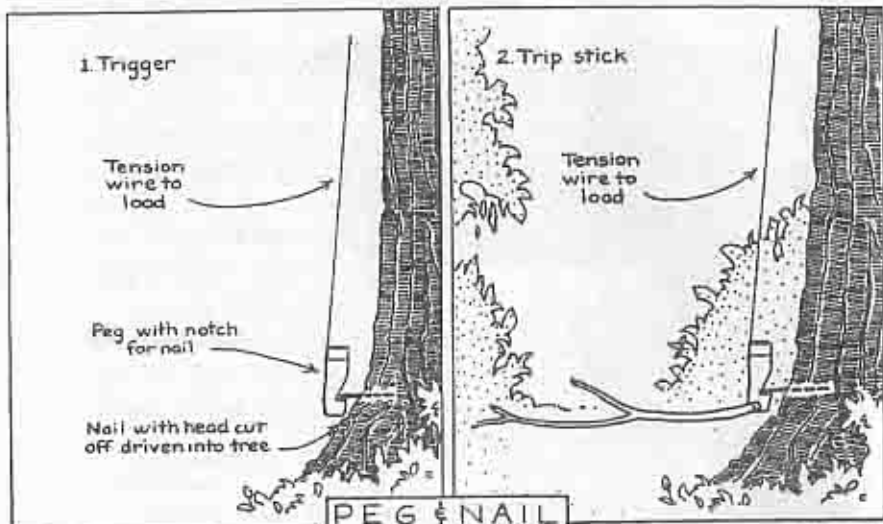

PEG & NAIL  
TRIGGER

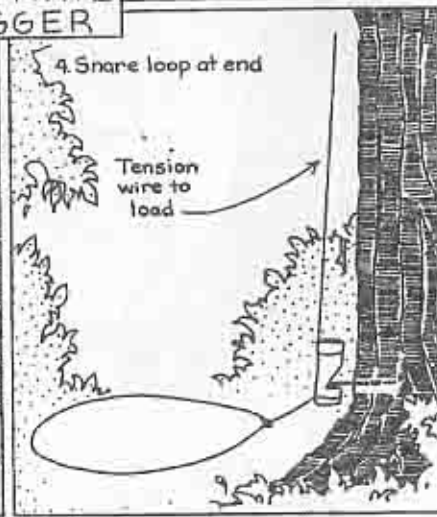
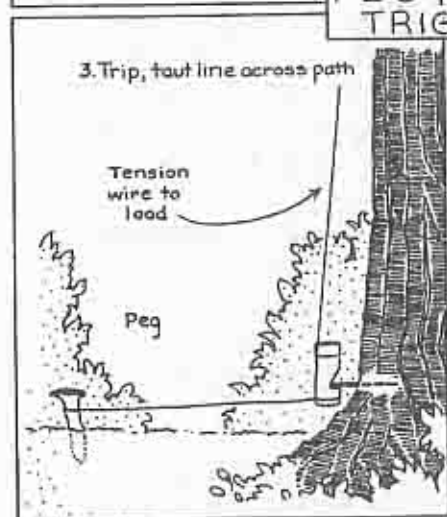

can be very sensitive too.

Wire from a spring (or tension) pole is run to a peg. Precut a notch in the peg before securing the wire. Drive a nail into a tree, log, or stoutly anchored stake, and that's all there is to this one. It can be triggered by positioning it so it is simply kicked out of position. Or the peg can be connected to a trip line, a branch, a stone, or by running a light wire snare loop to it. This last method is the most common use of the peg and nail trigger.

Always build the trigger fairly large for the intended application. In actual use I have found this to be the best way to make a sensitive trip. Cutting the head off the nail increases sensitivity greatly. A very heavy primary force exerted by the bent spring pole will cut the trigger's potential sensitivity substantially.

Be sure the peg is made out of the hardest wood available. Grooves cut in the top of the peg will help keep the tension wire tightly wound in place.

Be sure the mechanics of the trigger are such that a 90-degree pull off the nail is created when upset. Otherwise the mechanism may not activate without a huge tug or push from the quarry.

Often a fairly *insensitive* trigger is needed that can hold up a huge weight. Under these circumstances, the triggers are set in two stages, as previously mentioned. The secondary trigger may, for instance, be a stick and roller that holds up a log deck, which is tripped by a falling rock trigger.

Smaller traps occasionally may be built using the stick and roller as the primary and only trigger.

To be successful, the roller has to be made of materials that are smooth, round, and hard. It should be relatively large in diameter and roll on a hard surface.



At times it can be a real chore to get one of these triggers sensitized. One cannot go around rolling logs down the hill time after time till the trigger pieces are finally worked down enough to function properly. If nothing else, the trap setter will probably object to having logs rolled on his head.

When I make one of these sets, I start out with a relatively light load and implant temporary posts to stop the load close to the set. This way I can test the trigger time after time, adding a bit more weight as needed.

On a trigger of this sort, the best way to sensitize it is to angle the stick from the load to the roller. Another very effective method is to grease the roller and the pull stick slightly. Apply the grease sparingly or you may never get the trigger to hold again.

Other triggers exist that under the proper circumstances work nicely. Yet you will find that most are some derivation of the four mentioned. It has been my experience that knowing these basic designs is more than adequate preparation to perform the job at hand.

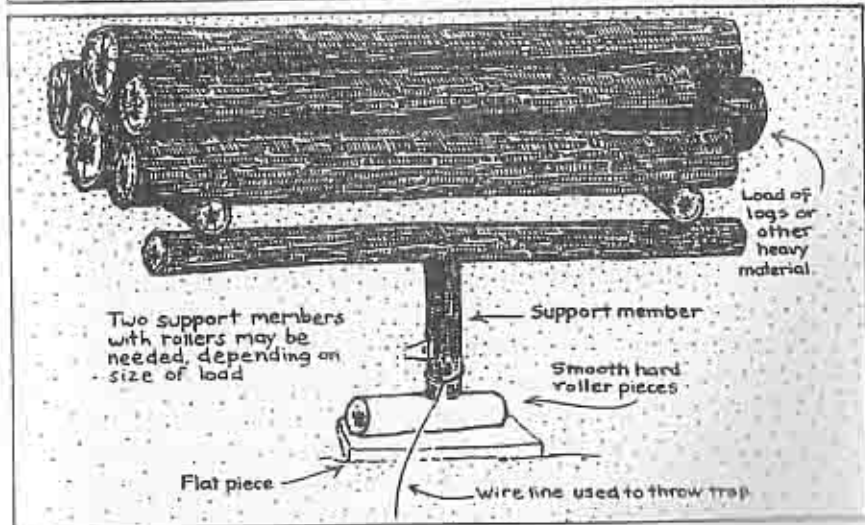
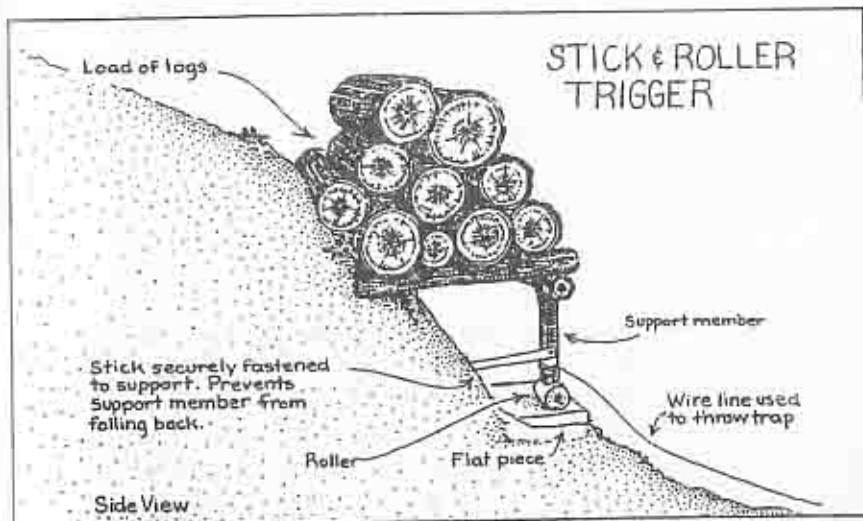

### 3. Pit Trap

Many people, when they think of a mantrap, visualize a hole in the ground dug in such a way that the enemy falls in and is impaled on stakes or captured. In real life it does not work quite that smoothly. But since this type of trap is the stereotype in people's minds, it is a fitting place to start.

Old hill country trappers know that under most circumstances it is virtually impossible to catch wild animals in a pit trap. This is a true fact, in spite of the "Frank Buck, bring-em-back-alive" tales you have heard.

But we are not concerned here with trapping wild animals; men *can* be caught in a pit. In actual practice, however, it takes a good deal more time and labor to put an effective pit trap into service than most people realize. And then the mantrapper must arrange some special conditions to really get the rig to work well, especially if the targets are people who are woodsmen.

Men on horseback are nearly impossible to pit-trap. The horses will sense the danger and avoid it. On the other hand, motorized vehicles are easy to lure into a pit trap if one is halfway clever about it.

A small truck or motorcycle has no brain. It cannot determine if it is headed for certain destruction, even if the signs are obvious. The operator of the vehicle is handicapped by the speed at which the vehicle travels,

## PIT TRAP LOCATION

Heavy foliage or  
other natural  
boundary keeps  
quarry on path

Sharp curve in  
deeply rutted  
narrow path

Pit trap

Vehicle tracks

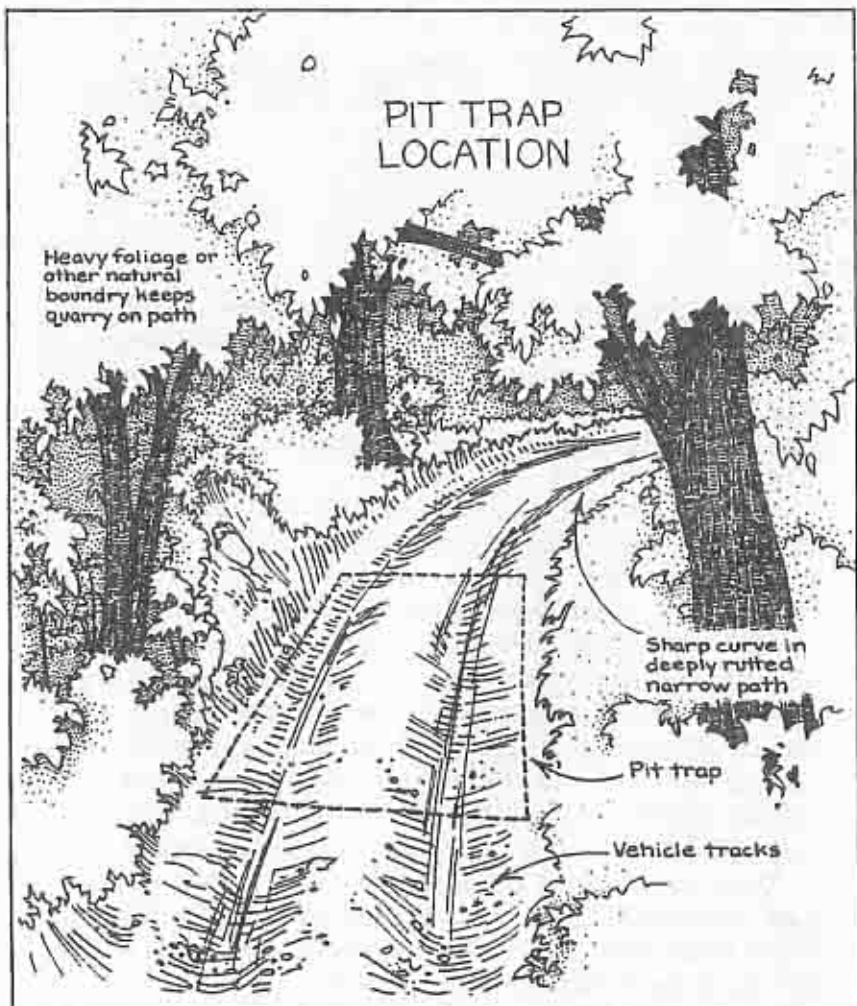



and the distance from the driver's seat to what may be abundant evidence on the road. Another plus for the mantrapper is that operators of vehicles tend to be lulled into a sense of false security. Obviously anyone who lets that happen is likely to find himself in someone else's hole, but it happens all the time.

Since pit traps are so disruptive to the environment, a great deal of attention must be paid to detail when digging them. You will need a relatively large crew of laborers who must be held closely in check, lest they trample every blade of grass and brush within 100 meters of the set.

The best approach I have found requires that you stage the workers off of the site 50 to 100 meters in a carefully prescribed manner. Be sure they know what path to take, where to dump the diggings, and that they cannot spill or trample.

Use lots of mats, canvas, or plastic sheets to protect the site as needed.

Careful consideration must be given to the location of the set. My preference is to locate the pit in an overgrown detour trail, covered with flattened vegetation and rutted as a result of men and vehicles leaving the road to detour around a fallen tree, washout, or other obstacle.

The very best location, in my opinion, is one where the temporary road or trail leaves the main road for a few dozen meters and then turns sharply back to the main path. The presence of tight, thick undergrowth will make the set work even better.

As the enemy leaves the main road, his vision will temporarily be obscured. In addition, the high, dense growth on either side of the detour should keep him on the chosen path. On turning the corner and straightening out for the run to the main road, the victim will

relax his vigilance. At that point the trap should be waiting.

As with all traps, locations with the correct criteria are not easy to find. Be double-damn sure, for instance, that you check the soil type before starting to dig. Are there large roots to hack through? Will cutting them kill the trees and alert the enemy? Is the soil rocky or swampy? Will the side walls of the trap hold or must they be reinforced with logs?

Keep in mind that pit traps have to be dug very deep: two meters for men and three meters for machines, at a minimum.

Surface materials should be retained for use in covering the trap. It must appear as though existing wheel ruts or boot prints go right on over the trap with no break in continuity.

The best way to do this is to use visqueen plastic sheeting. I spread the surface material, which has been carefully removed, out in large chunks on the plastic sheeting. Use three thicknesses for trucks, one for men.

After setting up the entire trap, have several men enter the hole from the side and hold up boards to support the plastic. New tracks can then be made by walking over the supported plastic, or by rolling wheels over it.

Using plastic makes it possible to place puddles over the set. Sometimes a giant puddle will work to obscure the whole set. Men won't go through if they can avoid the water, but vehicles are suckers for this puddle variation of the pit trap.

First-time pit trappers forget that they have to do something with the catch after it falls in the hole. Tigers, for instance, are famous for jumping out of traps. People will do likewise.

The only two really effective methods of keeping

# PIT TRAP CONSTRUCTION

Notches cut in braces so they will break easily

← Road or path →

Shallow covered entrance way allows men into trap to finish it.

Methods of bracing - from sides, bottom or both.

Pit lined with logs to hold loose soil.

Bottom of trap covered with spikes 18" punji sticks (may be covered with animal dung).

Clean, sharp edges - no sign of disturbance.

Trap should be deep, two meters for men, three for vehicles.

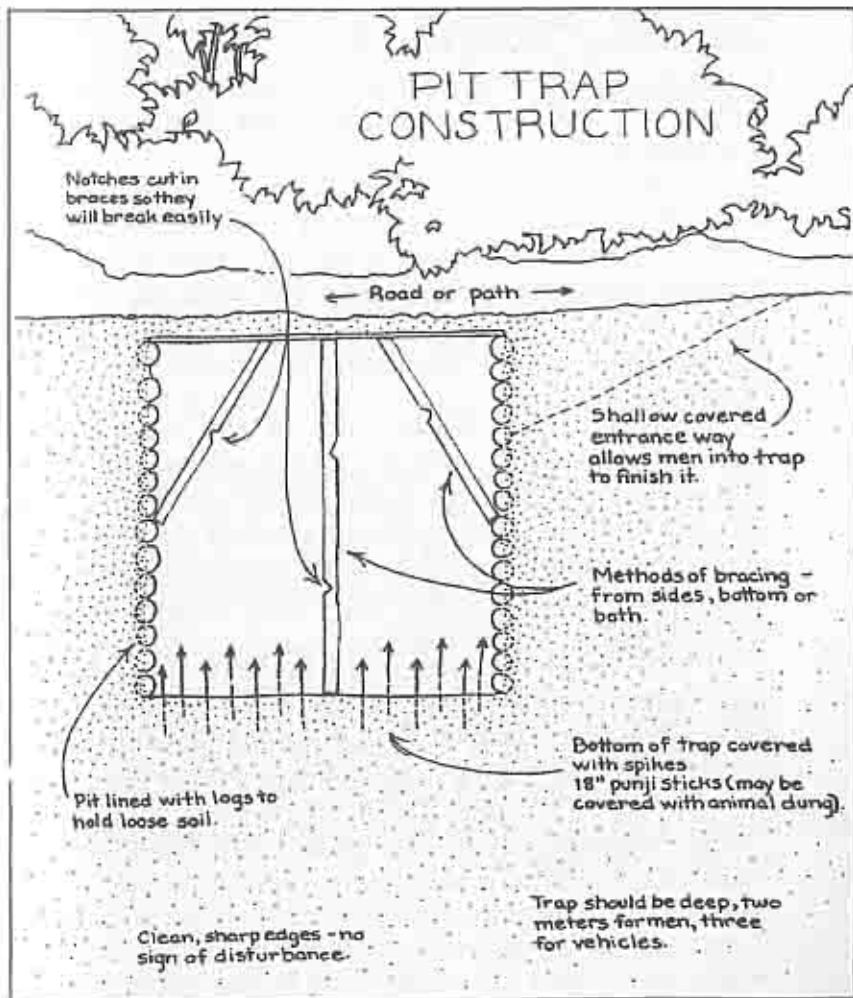

people in a trap that I have found are to plant punji stakes at the bottom of the pit for men, or flood the pit for a jeep. Theoretically it may be possible to drown troops in a deep hole filled with water, but it's unlikely. I, at least, have never seen it done. The best to hope for is that the vehicle will be damaged enough that it will be abandoned.

Adjusting the supports for the cover on the hole is an art. They have to give way crisply when the target crosses, yet hold the top cover nicely until then. I like to either whittle the supports down that hold up the plastic cover, or use a rigid hinged roof held up by a flimsy support on one end. Either method will dump the enemy.

The single biggest difficulty with pit traps is maintaining their secrecy. If the location is a good one, there is tremendous danger that enemy troops or vehicles will come by before the mantrappers are ready. There is no way to mitigate this problem. It will probably always be a handicap for the mantrapper who wants to use a hole in the earth to catch people.

In most places, a pit trap is not workable. Yet the skilled mantrapper has to keep the pit in mind when deciding which trap will work best in a particular situation. Sometimes that one-in-a-thousand situation occurs and a pit will produce real results. Another time a good working knowledge of the pit trap principle may save your life in the bush.

## 4. Sheepeaters' Rockfall

The Sheepeater Indians at one time inhabited some of the steepest, roughest areas of the western Rockies. No other tribe wanted to live on this inhospitable terrain, or for that matter, could even scratch a living from it.

According to legend, this small Indian tribe was held in low regard by the more advanced tribes around them. Apparently the Sheepeaters were considered to have had limited intelligence and only a rudimentary knowledge of the use of tools. Early anthropologists as well as the other Indians thought of them as dirty, uncouth people who were as much animal as human.

I believe that the Sasquatch legend probably originated with the Sheepeaters. They were the kind of people who could engender such rumors, since they lived in remote squalor and privation where only the mountain sheep, bears, and cougars normally existed.

What few Sheepeaters existed succumbed to smallpox. As far as is known, none survived past the 1880s.

Since the Sheepeaters were very primitive people who never learned to use bows and never acquired firearms, they were often hard-pressed to defend their natural rock territory against outsiders.

Early records are sketchy, but we do know that these little-publicized natives made extensive use of

# SHEEPEATERS' ROCKFALL

Rocks piled on platform; rocks should be piled in such a way that they do not seem obvious.

Stick and roller

Wire to trip rock; hidden by brush, grass or burned.

2 inch limbs buried in path with hollow space underneath

Trip rock

Hole dug in path

Rock fulcrum

enlargement

14 inch rock balanced against a small tree

Hole

Path through the woods

C L I F F

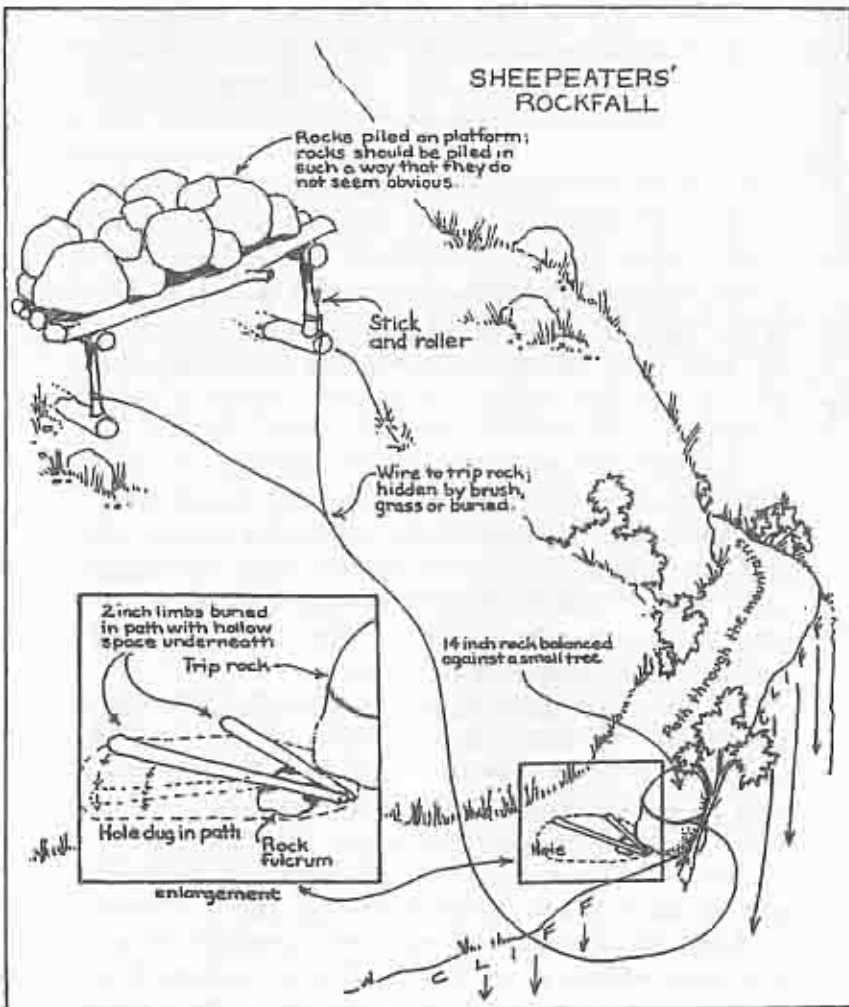

falling boulders to protect their domain. When combined with the rugged terrain and natural seclusion, the combination was enough to discourage even the most determined intruders.

Two fairly obvious prerequisites are necessary for the deployment of rock traps: large rocks, and sufficient altitude to make them dangerous. People who live in marshy, wet, flat environments, for instance, had best think of some other mantrap.

For those who will be operating mantraps in steep mountains, there is no easier way of storing up an incredible amount of easily unleashed energy than with the Sheepeaters' Rockfall. At one time I was even involved in a plot to drop a huge boulder on a tank, which I will discuss in "Jack the Tank Killer."

Under normal mountain conditions, a pile of rocks placed above a trail is not easily detected. The trap is one of the less difficult types to put in, since it is easily hidden and 95 percent of the construction activity is away from the path the enemy will be advancing on. It takes a pretty damned shrewd scout to keep his patrol out of a rockfall if they venture into the mountains in the first place.

The best place for a rock trap is from 150 to 300 meters above a path that crosses a broad, steeply sloping meadow. There must be at least a 25 percent grade, especially if the rocks are to be dropped from the shorter end of the recommended distance.

Multiple rockfalls made from higher elevations and longer distances tend to disperse as they gain momentum. The rocks begin to skip wildly into the air and will often miss the target. More material can be added to the fall, or the trapper can merely be content with scaring the hell out of the patrol. Of course, if a hit is made under these conditions, it will be a good one.

In very steep terrain it is sometimes possible to drop a load of rocks straight down. Usually this situation is a trapper's pipe dream, being virtually nonexistent in real life.

Pick a spot for the rockfall where there are no rock ledges, trees, or other natural barriers behind which the enemy can scurry.

When setting it up, I like to put the rocks on a log platform set into the hillside. When the trigger is hit, the platform will swing down like a hay door on a barn, dumping the rocks in a neat, orderly manner.

Using two prop sticks, I have made traps as long as eight meters that have held over 5000 kilos of rocks. By the time the boulders were 200 meters down the hill, they covered an area 70 meters wide.

The nice feature of this system is that two or three people carrying 40- to 60-kilo rocks can get a really lethal mantrap together in a very short order.

The main drawback to this type of trap is that usually the workers making the set are right out in plain view for God and everyone else to see. You can get around this by building it at night, or picking a location in a canyon where the view is restricted.

Another problem involves the availability of wire to trip the triggers. If it is completely impossible to acquire several hundred meters of heavy wire, constructing a rockfall is probably not a feasible idea. The best trigger for this type set up is a couple of good stout sticks and rollers, triggered by a 40-centimeter rolling stone. Rope running from the stone to the main trigger is not strong enough and is too obvious. It is imperative that number 12 or 14 wire be available for this purpose here.

Trigger the rock with two 5-centimeter limbs buried in the path. These limbs serve as levers. Be sure the wire



attached to the rock has enough slack to allow the rock to get some momentum before snubbing the wire tight on the stick and roller trigger. This is quite easily accomplished by hiding the surplus wire.

Be sure to take into account the delay factor when setting up a rockfall. It takes what seems like four years between the time someone hits the trigger till the rocks arrive on target. It is possible for the quarry to walk right out of the kill zone, since the time lag is so extensive.

Besides setting rocks on a platform, one can prop one big boulder on edge, with smaller rocks propped against it, holding it in place. Usually it is impossible to get enough sizeable rocks to fall at one time with this system to be of much value.

If you know that your area will be patrolled by large numbers of men, you might consider setting up a series of rock traps. It is possible to tie them together so that any one of three triggers will pull down a slide that in turn will pull down six or eight more. I have never tried this approach, but am sure that under the right circumstances it would be a real winner.

Guerrilla leaders with lots of able bodies might consider putting them to work on a multiple rockfall of this nature. It would be a good way to keep the troops busy, and the trap could very well protect one's back door approach into an area, or at least signal the approach of the enemy.

Be sure when setting the trigger for the Sheepeaters' Rockfall and when loading the stones, that you use safety poles. It is easy to misjudge the load capacity of a trigger, sending a ton of rocks down on you, and endangering the lives of friendly natives who might be down below.

## 5. Malaysian Hawk

I suppose that the reference to a hawk in this trap's name has to do with the fact that this device will swoop down from above and strike the intended victim. It impacts with devastating and demoralizing effect, out of what the hapless target had assumed was only air.

Not designed to snare or puncture, this set makes use of tremendous stored energy to whomp an adversary flat as a soggy pancake. Often the logs used to bludgeon the stumbling victim are not even sharpened. Brute force clears everything in the Hawk's path.

To work well, it requires the presence of large trees with a moderate to heavy undergrowth of brush and grass. Very heavy undergrowth hampers the operation of the trap to some extent, although it can be built to hack its way through, if necessary. Or the foliage can be cleared out a bit, though this tends to offset any camouflage efforts.

Remember, there must be enough leaves and brush present to hide the suspended log and to conceal the ropes.

Usually the best trigger is a trip stick, although we once built a Malaysian Hawk with a figure four. There's only one reason it never caught anything—nobody ever came along to set it off.

The swinging log portion of the trap is determined

by what one can reasonably expect to bring in and set up, the necessary weight needed to destroy the target, and requisite swift response time. All three elements must be considered. For example, one could haul a 600-kilo log up a tree on a long rope. And when it comes down, it will have plenty of momentum to do the job. The problem involves the response time. Everyone will be off the path by the time the Hawk swoops down.

My feeling is that a log in the neighborhood of 225 kilos tied up at a 70- to 80-degree angle on a 4-meter limb is about right. The enemy can easily walk under the log, yet the response time is short enough to maintain both surprise and a good weight-to-trip ratio.

The path along which the set is made must be narrow, keeping the enemy within a limited target area. Some unusually good trappers time the log's swing so it takes the enemy from the side on a right angle approach. My suggestion is to take the easy, sure approach and move the log down along the path in the same direction as the enemy.

Short, fat logs work best. Give the set a number of trial swings, since logs and ropes rigged in the wild are not always angled for a straight shot.

At times it is necessary to cut notches or put in spikes to hold the ropes in the correct position. Do this carefully so that the workings are not obvious.

The hold-back cord should be as light as possible and the pivot stick extremely frangible. It is possible to hang up the log as the pivot stick goes over the hold-back limb, causing the trap to strike short, especially if the trigger is made of heavy, clumsy materials.

After finding a suitable location, I have the troops haul in a precut log and set it on 35-centimeter blocks. I then balance the log on the end of the rope, making sure any extra rope stretch is played out, so even with

# MALAYSIAN HAWK

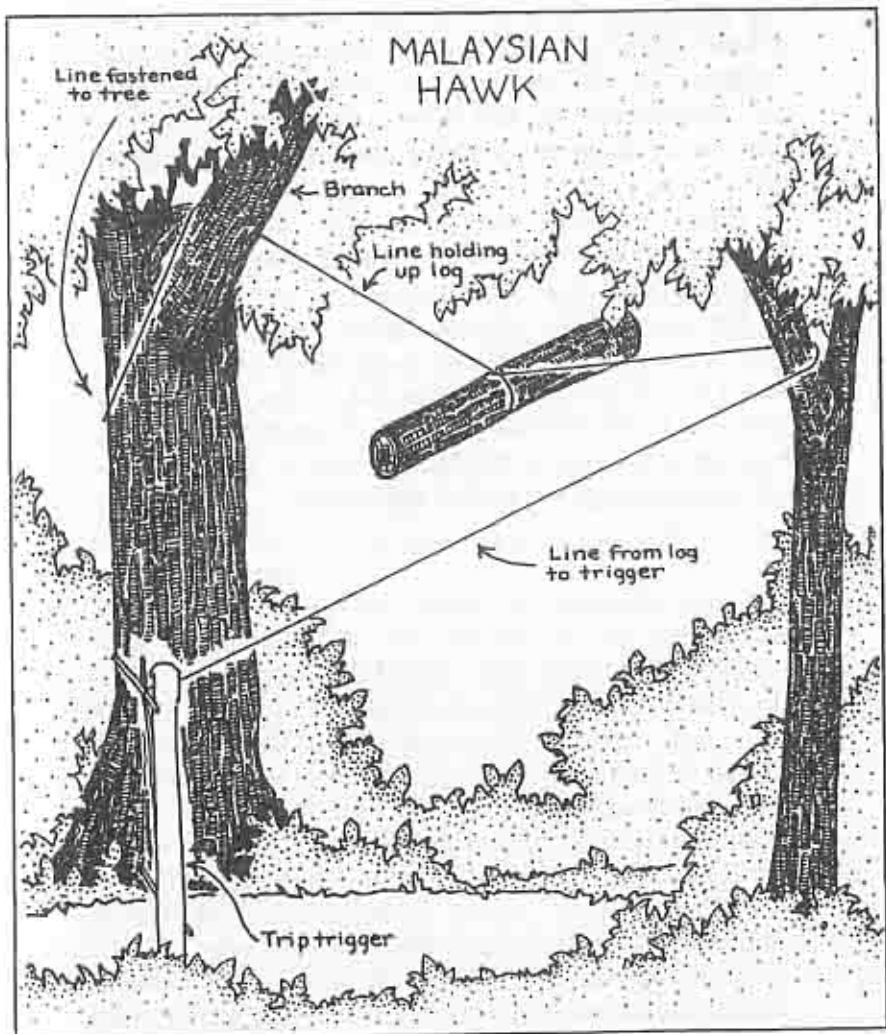

an optimum low swing the log won't hit below ground level in front of the target.

Tension on the post from the hold-back line can be intense, equaling about half the weight of the log. Compensate by solidly anchoring or using a fairly substantial tree. Camouflage the trip stick in the grass, cover everything with foliage, and beat the path down to its original appearance.

Highly motivated trap setters who have pre-scouted the intended location can have one of these little jewels hanging in place in an hour or less.

For years I have been fascinated by the prospect of using a Malaysian Hawk with a sharpened I-beam rather than a log, in the city on jeeps and trucks. Trucks can't jump out of the Hawk's path, so I'll bet the trap would be quite effective. It might not even be that hard to hide in amongst urban rubble and debris.

## 6. Chinese Chopper

Apparently the Orientals enjoy rigging contrivances that will, in some way, slam a huge log into their opponents. Instead of swinging a log down a path like the Malaysian Hawk, the Chinese Chopper drops a spiked log onto the enemy.

Depending on the terrain and cover circumstances, this trap can be *very* effective. But a dropping log is harder to conceal than one swinging through a light screen of foliage.

To be effective, the Chinese Chopper must be set up with perfect balance. The log should fall flat on its target. Even small branches can upset this balance, deflecting the log harmlessly from its appointed duty, or perhaps lessening its striking power.

On the plus side, a dropped log can be set so that it makes very little noise when released. This feature enhances the trap's effect, since a noise alerts the intended target. A noisy trap with a long drop will invariably miss-strike, even at night.

One way to offset the alerted target's immediate tendency to get out of the way is to set the trap at a place in the trail where the consequences of leaving the path are as bad as staying where the log will fall. Several years ago we found an ideal location in a wooded area high in the mountains of the NFD area in Kenya. The



Drop log must weigh at least 400 kilos. Because of tremendous weight, it must be well anchored.

Pegs inset in bottom 1/3; 20p. nails; sharpen after in position with metal file.

Log hangs to fall parallel to path. Camouflaged by branches & brush.

## CHINESE CHOPPER

Trip peg should be hidden behind grass & under brush.

path crossed a saddle at about the 6,000-foot level and then started to wind down a very steep rock canyon. Some tall cedar trees were available to hang the log on. When the log dropped, the quarry could either jump over the cliff or get squashed.

The set worked twice, a high success rate for any mantrap. Both times we caught marauding Rendille warriors. Informants later told us that the Somali Shifta we sought were with the party, but escaped injury. According to rumor, one of the Somalis had jumped off the cliff but was not hurt. Some of the others were injured. The Somalis are incredibly more alert than any of the Bantu and always kept out of our traps.

An effective drop must be made from no less than 3 meters above. Four meters is better and probably also is the maximum distance. The log should weigh at least 400 kilos and be no less than 2.5 meters long. In actual practice, this is not really a large enough object to do the job adequately. Added length would yield a greater likelihood of achieving at least one and perhaps two strikes. The problem, obviously, is that as a longer and longer log is used, the weight per square meter of strike area is reduced. The target may suffer just a bad headache, with no long-term injuries.

The Orientals compensate by putting spikes in the log. Using 20-penny nails with sharpened ends would do the job, or boring holes in the log and imbedding 3-centimeter hardwood spikes that stick out about 15 centimeters will work well if no nails are available. The bottom of the log should look like a prickly earth packer.

The outfit is better hidden if it's triggered by a trip peg with turn stick or wire. The only real tipoff on these traps is the log hanging up in the sky for all to see.



Use either ropes or wire to raise the drop piece.

Start by balancing the log on the drop wire. The log must hang parallel to the path. If the path is not level, adjust the tilt of the log.

Large logs sway in the wind and movement might give the trap away. I recommend tying limbs into position to hold the log. Do not, under any circumstances, tie the log into position with rope or even light string which could deflect the fall.

A 400-kilo log is about the largest mass the average mantrapper can handle. It is difficult to raise more weight than that, and to build a trigger that will accommodate heavier loads.

Theoretically, the rope or wire holding up a 400-kilo log will have to support only 200 kilos after it encircles the support branch. Friction on the tree limb further reduces the load, but the load on the trigger is still awesome.

Some triggers use a double pulley arrangement to reduce the load on the trip, but there isn't a single one that really works. A clean, sharp drop happens only when the log is strung on a single wrapped line.

The best advice I can give is to use large heavy pegs on the trigger, and to keep the anchor peg or nail as short as possible. Use caution as these heavy loads produce extremely light triggers under some circumstances. Nothing reduces morale more than falling prey to your own trap.

Ropes, wires, or even vines can be used to build this trap. Remember, it takes only a short piece of heavy support material to hold up the log. Once the line doubles over the support limb, it is advisable to use lighter stock to hold the drop.

A log is the recommended drop, but whatever is used should look reasonably natural dangling in space,

and strike an area rather than a point. A boulder might dent a hole half a meter deep but not scratch a target half a meter away.

Scout your locations ahead, and then go in with a large crew capable of putting in three to five Chinese Choppers on the same trail. If conditions are right, you might want to use them as often as one every 100 meters.

It is disconcerting as hell for the enemy who have to patrol the area.

## 7. Cuban Water Trap

In 1956 I had the opportunity to spend seven months in pre-revolutionary Cuba. Batista was still firmly in control at the time, but the Castro brothers were active enough to make life interesting for a young mercenary.

One of my duties, in keeping with my cover as a gringo tourist, was to take an interest in caves. Cuba has a great number of caves. Before 1960, some were actually developed as tourist attractions. Others were just holes in the ground where the revolutionaries stock-piled propaganda posters, among other things.

Our little saga started on the beaches of Veradero where I lolled around watching girls and spearing fish. Great numbers of 28- to 40-foot fishing boats plied these waters. Most, I was told, came from Miami.

I noticed that whenever the state military beach patrol was out of sight, some of the boats would quickly offload OD green boxes into small skiffs that ferried the boxes ashore. Once on shore, the suspicious wooden boxes disappeared, never to be seen again. At least I never saw them again.

Every so often a contact named Armando appeared, who looked like an ill-kempt *campesino*. Armando would whisk me off on a three- or four-day swing around the island to inspect various caves. It seemed like every

cave inspection required a five-kilometer hike in the stifling jungle heat. But I dutifully went on these assignments in anticipation of the fish-spearing activity that would come later.

After several months of this mucking about, it didn't take much genius to conclude that the best deal was back on the beach inspecting swimming suits. For that reason, I never philosophized a great deal about the cave portion of the business.

But my jungle forays did provide me with opportunities, on several occasions, to analyze an ingenious mantrap that is probably indigenous only to Cuba. I doubt seriously if it is used any other place in the world. Probably the set is not even used in Cuba any longer. Other than my knowledge of it, it may be lost to history. I call it the *Cuban Water Trap*.

My first introduction to this trap came on my fifth or sixth visit to one particularly grungy cave about 120 clicks from Havana. The same dirty little unshaved Cuban, Armando, was showing me around the dank hole in his typical bored fashion, when the power went out in his two-cell flashlight.

Rather than sit around waiting, I started climbing up toward a light I could see in the distance. Armando chattered away nervously and followed along. At this point in my Cuban career, I could understand about half of what he was saying.

Eventually we emerged high on a lush green hillside. Vines and grass partially covered what was actually quite a large hole exiting the cave. The valley floor lay below us about 200 meters. I could see the creek but not the trail or the cave entrance, which was skillfully hidden in the undergrowth.

To my right, about halfway down the hill lay what looked like a fairly good-sized reservoir. Enough brush

obscured the view that it was impossible to tell for sure. Armando noted my interest in the curious reservoir. My little guide, now alert for the first time since I met him several months back, waved for me to follow him down the slope.

The pond he showed me was approximately one hectare in size and fairly deep. I don't know exactly how much water was in the impoundment, but it seemed like quite a bit.

Feeding the pool was a creek that ran down the valley. The dam holding back the reservoir was constructed within a grove of trees. It was made entirely of 20- to 50-centimeter logs filled in with brush, vines and moss.

Below the dam, water escaped through cracks and holes, cascading noisily down till it ran into the creek again. No water spilled over the top. I wondered what would happen if a sudden cloudburst, a common occurrence in Cuba, sent extra water surging down the creek into the pond. Apparently the dam could take it.

Green scum hung over the barrier logs like a blanket. It looked to me like the whole rotting mess was about to collapse any minute. My guide took me around perilously close to the front of the dam. From there I could see the logs laced together like fingers. The ends bowed out, pointing downstream at a shallow angle.

Two log braces were set against the middle of the barrier, like stick and roller triggers holding back a rock-fall. It was obvious that they were all that was holding the contraption together.

Smiling like an American politician on election day, Armando pulled a piece of wire cable out of the grass and showed me where it was attached to the two log braces. Carefully he hid it back in the grass again. We continued our stroll down the trail, past the main en-

trance of the cave. Here the trail snaked on through dense undergrowth.

Off to the side, not 20 meters below the cave, was a large round rock every bit of one meter in diameter. It lay there, obscured by brush, propped up by a figure four trigger. Gingerly my guide showed me its horizontal trip stick hidden in the path.

By a series of grunts, motions, and a little Spanish, he explained that the trigger tripped the rock which was then dumped into a two-meter-long chute. At the end of the chute, the rock pulled the cable tight, snapping the two braces away from the dam. In theory, anyway, the water would come cascading down the little valley, washing away all men and vehicles unfortunate enough to be in the way.

Later I asked Armando, who spoke perfect English when he wanted to, about the setup. He claimed the trap really worked. Any Batistas coming up the trail would trigger the device, creating what seemed like a natural disaster. Armando claimed the revolutionaries always tried to put their caches in caves in this type of valley. He said they could protect the cache that way without raising suspicions.

I asked if a trap like this had ever been hit by the Batistas, and was told yes. "The logs tumbling in the water are deadly," he said. "Inside the cave there is some water, but most goes on down the valley. It is very effective," he claimed.

In this case I really don't know if he was telling the truth. I do know that in the course of my travels I was able to confirm the existence of at least two other Cuban Water Trap reservoirs.

This mantrap's concept is ingenious, but obviously there are problems. The set has to be viewed as a special case situation, more so than any other system in this

# CUBAN WATER TRAP

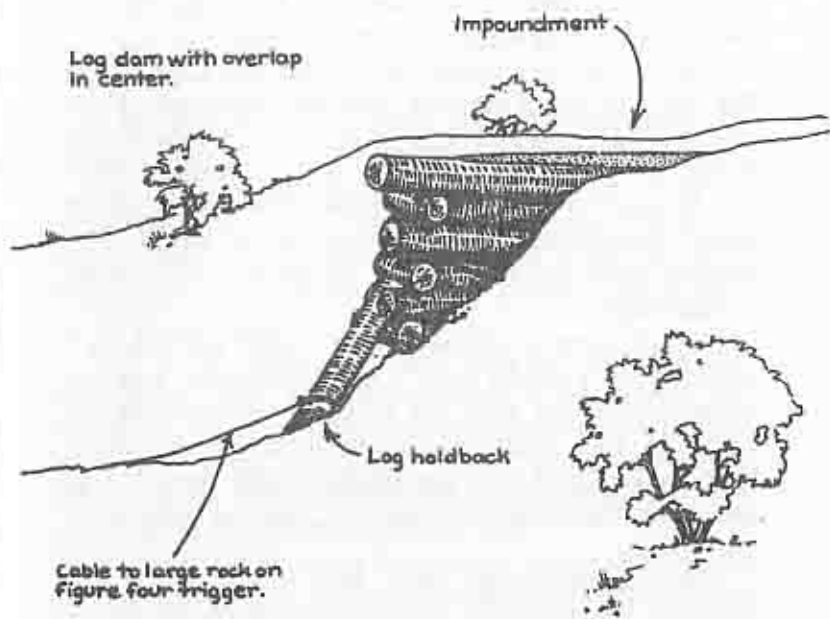

book.

Valleys in which a water trap can be constructed must be small with fairly steep side walls. Obviously a steady, nonseasonal stream has to flow down through the bottom of the valley. Small trees and underbrush that can hide the pond, trail, and trap rigging are important. On the other hand, the cover cannot be too dense or the trees too tall, lest they break the flow of the water and logs when the dam gives way.

Part of the destructive force of the trap comes from the logs and debris tumbled along with the water. From my point of view, the logs in the dams I saw looked rotted and soft. This may have been illusionary. They did manage to hold back a pond about four meters deep. Nevertheless, one had best make certain that suitable building materials are on hand for a project of this scope.

Constructing a suitable trigger would seem to be a monumental problem here. I often wondered how the trapper could tell what size of brace was sufficient to hold the dam back before the pond actually filled. If it looked weak, the mantrapper *could* open a hole and drain the pond. If it broke it might be possible to start over.

The trigger system itself does not seem unduly complex. After thinking about it off and on for almost twenty-five years, I have concluded that I would, if ever called on to make a trap of this sort, also use a large boulder with figure four trigger to pull a cable which, in turn, yanked out the dam braces.

Constructing a Cuban Water Trap is nine-tenths art and one-tenth luck. I am not even absolutely sure it would work as planned, my friend's assurances notwithstanding.

Yet it is an interesting mantrap. I am sure the idea merits application someplace in the world today.



## 8. Andes Mountain Trail Trap

I am told that this design was originally used by reclude civilizations living high in the Andes Mountains to protect their mountain hideaways. The trap bears a strong resemblance to the Sheepeaters' rock trap previously discussed; however, the Andes Mountain Trail Trap substitutes a large log instead of the rockpile used by the Sheepeaters.

The Andes Mountain traps were set along narrow trails in areas where the paths crossed a canyon rim or a very steep, very restricted area. Apparently log retaining walls often were constructed to hold back the hillside. The log walls were common enough so intruders were caught off guard by the occasional trap.

In our times the trap has limited application, as the set will work only on well-established paths in steep mountains where there are stands of larger trees. To the trap's credit, however, a small crew can set the device on enemy turf about as easily as any mantrap described in this book. For that reason, I consider the trail trap to be somewhat offensive in nature.

The heart of the trap is a log 3 to 4 meters long, weighing no less than 300 to 500 kilos. Depending on its weight, pick a log 35 to 50 centimeters in diameter. Keep in mind that the log has to do its damage rolling

## ANDES MOUNTAIN TRAIL TRAP

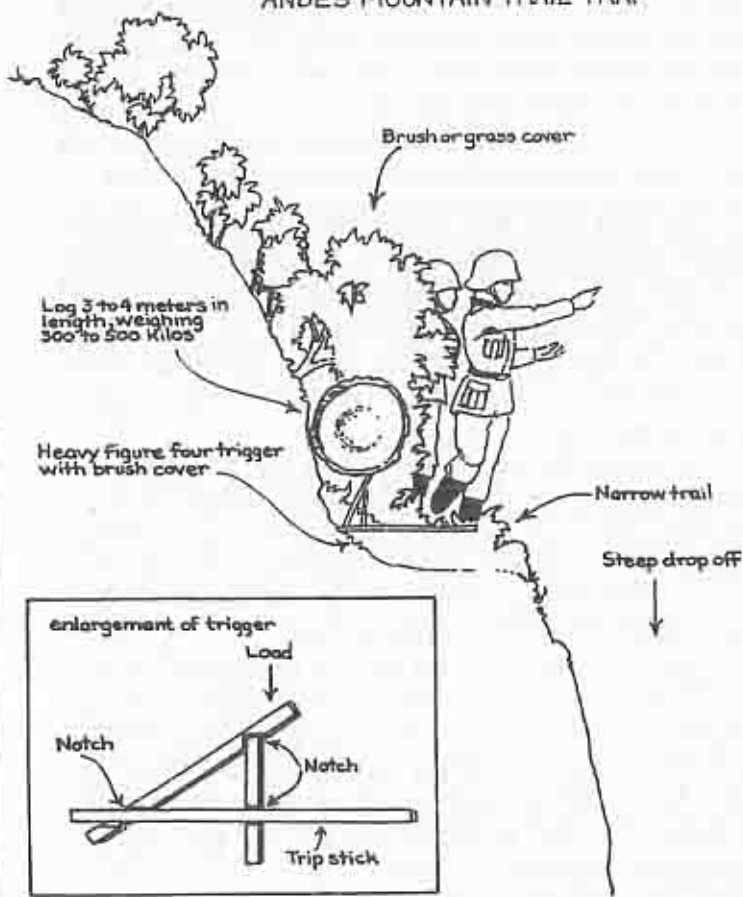

less than 1 meter. A log the enemy can catch and restrain is not heavy enough.

Be very sure the log is straight and round. All the branches should be trimmed off in such a way that there are no obvious scars to warn the quarry away from the set. I prefer using clean, branch-free logs in the first place, thus avoiding having to paint trimmed spots with mud.

Positioning the log is always a hairy task since, to be effective, the set must be made on an extremely narrow piece of trail, preferably in a place where the canyon falls away several hundred feet below. Try lowering the log from above on ropes if the project can be managed without tearing up the mountainside. This maneuver works only if the log can be cut above the set, if you have enough rope, and if there are trees to snub to. Sometimes the log can be carried in if there are sure-footed porters. Or it can be rolled on a small wheel fastened to the rear of one end.

There is no simple way to place the log, especially on a treacherous mountain path. Try to pick an accessible location and be prepared for hard physical labor. As a last resort, shorten the log or find someplace else to do the job.

Ideally the uphill bank should be angled less severely than the dropoff below and have at least some grass or brush cover. Set the log in the trail. Raise it with a pry bar and hang it by either end on a rope supported by poles. Swing the log against the bank and pull all of the brush and grass out from underneath to disguise the fact that there is a new log perched there ready to roll off the mountain.

Make a stout figure four trigger. Place a flat rock under the vertical support piece to keep it from sinking into the ground. Work your way up the log half an

inch at a time till you find the balance spot somewhere in the middle. Usually the log won't balance perfectly. I put a thin little branch under the heavy end to help hold the log up against the mountain.

Be sure to clean up all approaches. Cover any drag marks in the trail and dispose of freshly disturbed stones. Disguise the fresh cut ends of the log with brush or rocks. Also lightly cover the figure four trigger with foliage. Keep the trip stick short. People inching along a narrow trail will always keep to the inside. They always seem to hit the trigger without any other elaborate preparations.

When tripped by the quarry, the log will either push the target off the mountain or break an ankle or two.

The set is not effective in sequence. One bout with an Andes Mountain trap is enough to make anyone suspicious of any more logs along the trail. Yet the set will do a commendable job of protecting a path from night patrols. It will force the enemy to contour the mountain off the established route, or to wait till daylight.

inch at a time till you find the balance spot somewhere in the middle. Usually the log won't balance perfectly. I put a thin little branch under the heavy end to help hold the log up against the mountain.

Be sure to clean up all approaches. Cover any drag marks in the trail and dispose of freshly disturbed stones. Disguise the fresh cut ends of the log with brush or rocks. Also lightly cover the figure four trigger with foliage. Keep the trip stick short. People inching along a narrow trail will always keep to the inside. They always seem to hit the trigger without any other elaborate preparations.

When tripped by the quarry, the log will either push the target off the mountain or break an ankle or two.

The set is not effective in sequence. One bout with an Andes Mountain trap is enough to make anyone suspicious of any more logs along the trail. Yet the set will do a commendable job of protecting a path from night patrols. It will force the enemy to contour the mountain off the established route, or to wait till daylight.

## 9. Spike Trap

The age-old Spike Trap has been used to deter both man and beast. I once came across a photograph of a device made to mantrap poachers, constructed about 1650 by an English blacksmith. But whether the trap is intended for two- or four-legged animals, the design is alive and well today, used by a number of different bush native societies to guard their home territories.

Spike Traps are particularly effective for use against horses. Perhaps because I am an old duffer who was raised around horses, I still respect and believe in horses. They are as good a means of transportation for some military forces under many irregular guerrilla-type situations as will ever be found.

Because I perceive horse-mounted troops to be a threat to me, I have probably spent more time than the average irregular soldier trying to figure out how to handle them. In that respect, the Spike Trap is the answer to a maiden's prayer. Properly set, one trap can do in 5 percent of a company's horses every time they patrol the defended territory.

A Spike Trap can be set any place a 1-meter hole with 25-centimeter sides can be dug—in trails, at river crossings (it doesn't matter if the trap fills with water), in open fields, or wherever. In some places the trap can be rigged, left six months, and still produce a catch.

Although actually installing the trap is not difficult, preparing the unit is time-consuming. If the objective involves setting traps in batches of at least fifty, the only practical approach is establishing a small production facility to make trap bodies.

Under most circumstances the trap bodies should be 25 to 30 centimeters on a side. The traps don't have to be square, yet in most places square construction materials are the easiest to scrounge. Use wood, metal, cast iron, pipe, or anything else handy—don't overlook 20- to 25-centimeter pipe. Use a box, from 70 to 100 centimeters long. My experience is that the trap works best if the victim has trouble finding the bottom. Of course, it isn't practical to build a trap that would swallow an entire horse leg. But put a human up to his thigh in a Spike Trap and you have something.

No matter what the side walls of the trap are made of, they should be tough enough to hold the spikes without bending. My personal preference is 16-gauge tin. Material of this sort can be obtained, bent, and soldered just about anywhere in the world.

The spikes must be fairly tough. Twenty-penny nails, or an equivalent size, are as small as one should consider using. Or make the spikes out of steel rod, slivers of heavy sheet steel, old bedsprings, and other similar junk. Be sure the ends are needle sharp.

Securely mount three spikes on one side and two on the other, not more than 3 centimeters down from the top of the box. Bend the spikes toward the bottom on an approximate 30-degree angle into the box. When completed, the opposing sets should have a gap of about 7.5 centimeters. There must be a significant slope down to the spikes.

Carefully dig the boxes into the ground. Carry away all the surplus soil. Covering can be made with anything

# SPIKE TRAP PLACEMENT

Covered with  
natural materials.

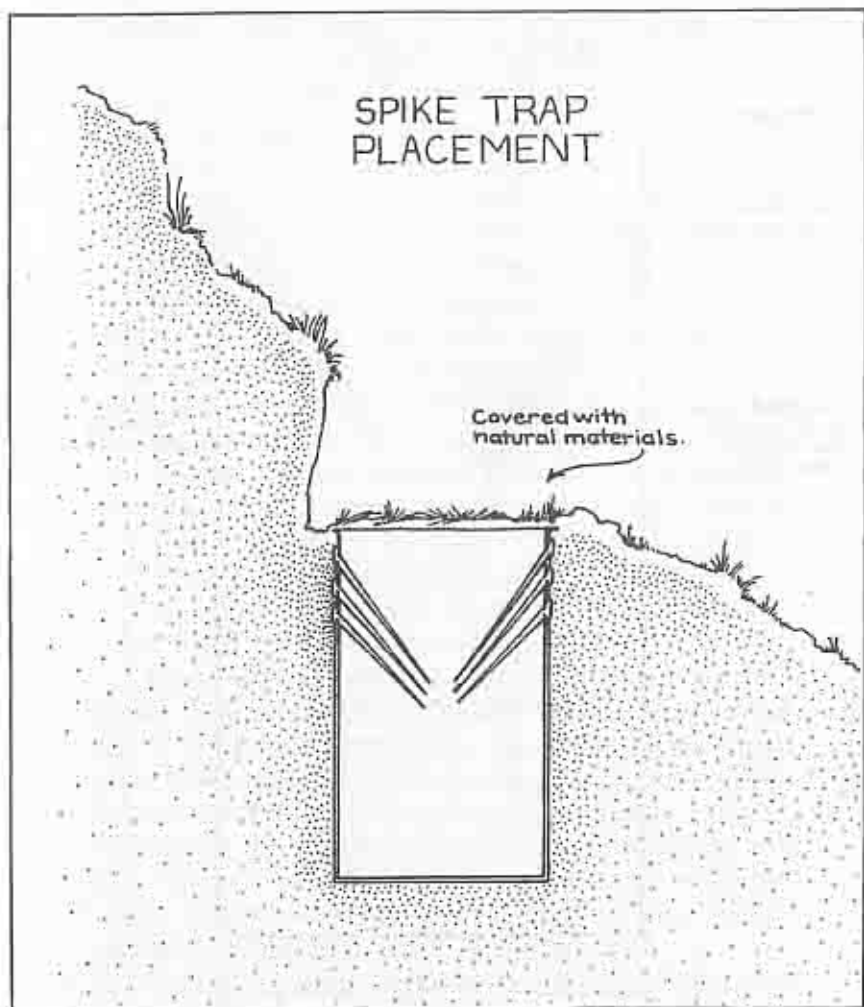



# SPIKE TRAP CONSTRUCTION

Ends open

Side walls no less than 16 ga.

Tough sharpened  
tines securely  
fastened to  
side walls

70 to 100  
Centimeters

25 to 30  
Centimeters

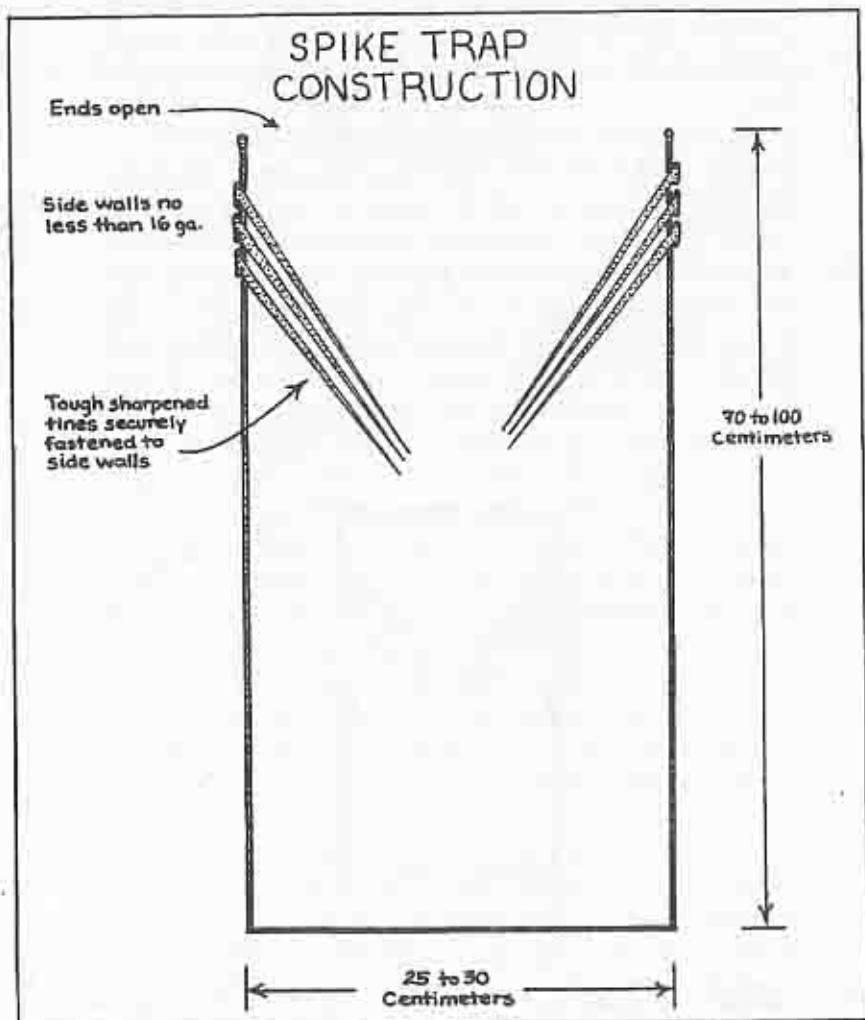

that does not arouse suspicion. On a dry, dusty path try a leaf or piece of paper, covered with dirt. On one occasion I used pieces of sod, but after a week or ten days, the grass dried out. Every set was extremely conspicuous, and had to be recovered.

Spike Traps may be placed at the bottom of a small incline or at the top of a hill, places where the quarry is likely to step down harder than normal. Horse traps should be placed where the horses will go. If the trap is well covered, the critter won't spot it.

Once any portion of a foot passes the bottom of the spikes, the quarry is had. After they gain experience with this type of trap, humans will kneel down, lean on their rifle, or pull on a branch to keep from going in farther. But most of the time the quarry will sink deeper and deeper, the nails digging in progressively. Sometimes the trapee will manage to remove his shoe and escape. Escaping is tougher if the trapped person had a pack on and was tired when he lost his footing.

Invariably horses that get a foot in one of these traps thrash around and break a leg.

Of all the mantraps described in this book, the Spike Trap is probably the least lethal. Its advantage lies in the wound it produces, which will cripple a man for a few weeks, and in the confusion and consternation caused when someone gets trapped. Especially at night, the results are dramatic. The entire patrol usually will stop. Several men will have to unearth the trap and break it apart noisily while everybody else stands around contemplating their exposed position.

Possibly the trap can be made more lethal by covering the spikes with snake venom, nicotine sulfate, or some other poison. That's a matter of personal preference.

## 10. Jungle Snare

Certainly everyone will agree that any book on mantrapping has to have a section on snaring folks by the foot and simultaneously springing them up into a tree. Everybody knows from watching forty-year-old John Wayne and Tarzan movies that this is how it should be done.

In real life, a spring-loaded Jungle Snare is a viable mantrap. A snare works well anywhere there are trees with a trail through them, some ground cover including a few bushes, and an enemy that will venture into the area.

A good snare set is simple enough to build, yet incredibly tough to avoid. About the only people who can consistently stay out of such snares are natives who live very close to the earth. They tend to walk by placing their feet up and down. We shufflers, inhabitants of modern and developing civilizations, don't have a prayer. By the time we feel the snare pull on our foot, it is too late.

There are literally dozens of different methods of setting very good, very effective jungle snares. Some are absolutely ingenious. However, most of the ingenuity is related to producing a mortality, rather than getting the victim into the set in the first place.

First things first—here's how to get the snare on the

enemy's foot. Construct the snare out of 20-millimeter airplane cable or any other light wire that will withstand a jerk load of 300 kilos. Number 16 copper appliance wire qualifies; baling wire or regular deer snare material will do the trick, too.

The loop should be about 30 centimeters in diameter. If the snare is too small, it trips before the target's foot is completely trapped. The snare simply pulls a boot or slips off the foot.

Leave some slack—perhaps 10 centimeters—in the wire. Lightly anchor the bottom of the loop right to the ground. Make sure it stands up perpendicular to the path. I like to tie up the snare loop with a single blade of dry grass.

Unless the snare is to be used only against night patrols, another precaution must be taken. It must be hidden from view. The best way to hide the snare is to make the set where a branch or bush overhangs the trail at a height of about 1 meter. The enemy will see the branch as a light obstacle that he can push aside. But he won't be able to see the ground and/or the snare. A few weeds in the path or some other foliage will help obscure the wire.

Set the wire up to the right or left in the path. People don't have feet in the middle.

Use a peg and nail trigger as described in chapter 2.

Hanging some poor guy temporarily in a tree is one thing. Producing a casualty is another matter. Here is how I recommend doing the quarry in, once he is in the snare.

Hoist a 250-kilo log or stone up a tree by throwing the snare wire over a stout limb. Position the weight at least 6 meters high. Run the line up behind the tree trunk and hide it from view as much as possible. It sometimes works to suspend the log or stone behind the

# TRADITIONAL JUNGLE SNARE

Weight at least  
3 times as heavy  
as intended target  
Suspended at least  
6 meters from the  
ground, hidden in  
overhead  
foliage

Bent over bush  
observes view down  
on snare

Peg & nail trigger

Snare loop 30 cm  
in circumference

Downhill drop

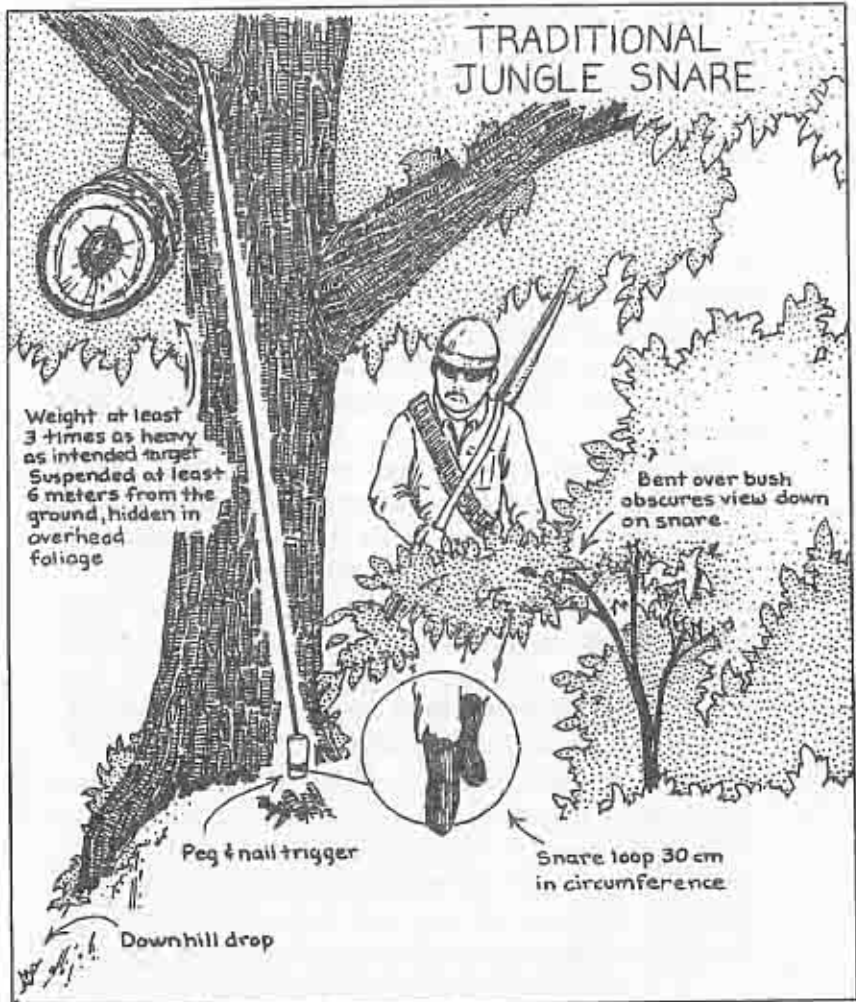

tree. Just be sure the hoisting path is not obstructed by large branches.

When the trigger is tripped, there should be enough weight to *jerk* the victim off the ground and pull him high into the tree.

Tacking a piece of tin on the limb over which the snare wire runs will smoothe the operation considerably.

It is possible to produce a fatality using this method without resorting to strapping scores of spikes in the tree or other similarly difficult procedures. Picking the trap location becomes crucial for this operation. Locate a tree on a raised bank alongside the path. If the weight drops farther than the victim is raised, it will drag him over the limb. He will seriously break a leg, at the minimum.

Things to remember with a trap of this sort include using a strong enough wire, hidden from view, on a well-traveled path. Drop a load at least three times the weight of your intended target. Doubling a wire over a limb halves the weight that can be lifted. Drop the log as far as possible, dragging the victim over the support limb, if possible.

The Jungle Snare is a good device to add to your bag of tricks. The orthopedic surgeons in the area will love you dearly for using it.

## 11. Jivaro Catapult

In 1957 Jivaro Indians killed five men who were close friends and acquaintances of mine. The incident occurred deep in the Amazon River Basin, far from anything resembling civilization.

As a result of that incident, I began to study the Jivaros. At one time in my earlier years I had even hoped to make a trip to South America to meet some of these talented people.

Two special attributes impress me about the Jivaros. Other than some Somalis, the Jivaro Indians are the only people in the world who can track men by smell. And, more pertinent to this book, they make extensive use of mantraps to protect their territory.

Two years later, another friend was on assignment photographing the Jivaros and their country. The photographer had the dubious honor of filming the death of one of his porters, impaled by a Jivaro Catapult.

I studied the photographs of that incident very carefully. Eventually I was able to construct a similar mantrap. Probably the only difference was the trigger. I never could figure out the original mechanism.

As the years rolled by and I got myself into one scrape after another roaming the world's trouble spots, I had the opportunity to share the Jivaro Catapult with others. It wouldn't surprise me a bit if some of the

# JIVARO CATAPULT

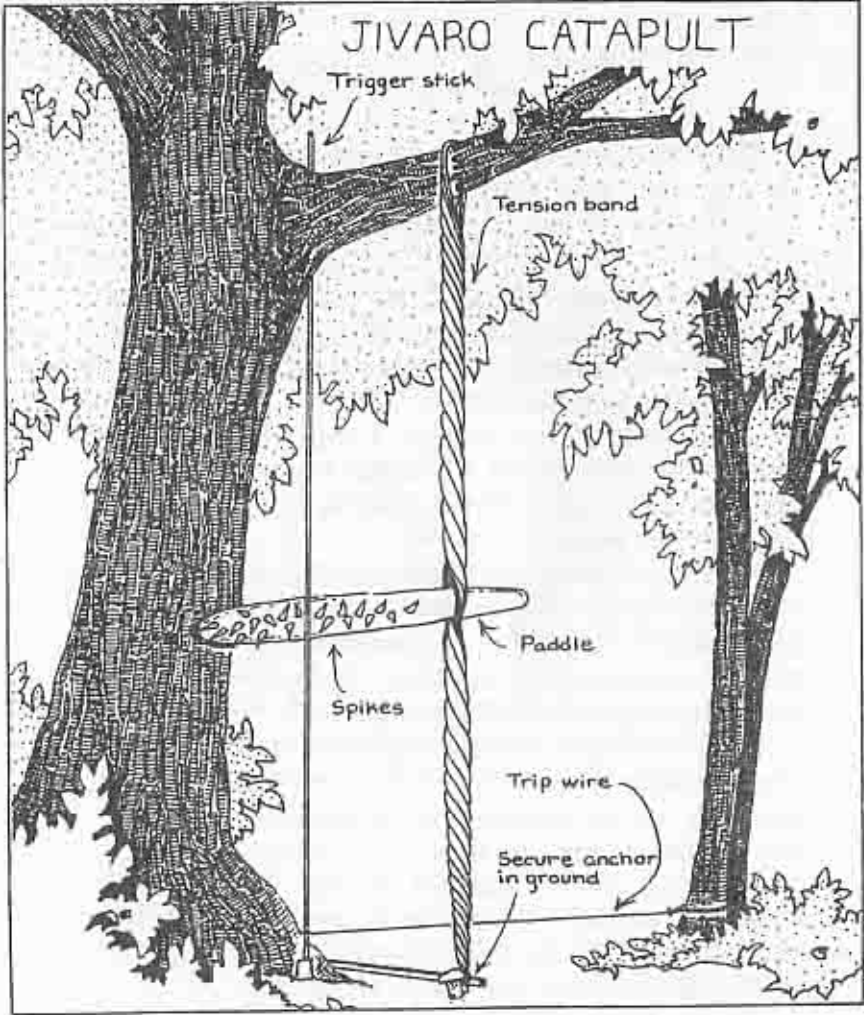

Trigger stick

Tension band

Paddle

Spines

Trip wire

Secure anchor in ground



Somalis I taught are still using the catapult today to send Cuban mercenaries to the eternal cane mill in the center of the earth.

The Jivaro Catapult requires lots of ground cover and foliage to hide it, but the cover definitely does not have to be as extensive as that provided in a jungle. As I mentioned, the trap is probably still being used in Somalia and that, friends, is not jungle. We made do there with sisal, baobab trees, and bunch grass for cover.

The heart of the trap is a tightly wound, spring band that holds and swings a spiked paddle. Half-centimeter wire rope, if available, is ideal for the band. Or use fresh new hemp rope, vines, or even leather. Apparently the Jivaros made their bands from vines that were extremely rubberlike and springy. My experience with rope and vine is that this material loses its tension after a few days, especially in the rain.

Construct the paddle out of something fairly heavy, such as a board, limb, split log, or piece of steel. It should be about 10 centimeters wide and 1 meter, or slightly more, long.

Mount six to eight, 10- to 12-centimeter spikes in the end of the paddle. Inset them securely in the paddle and space them not too close together. The Hindu who lies on a bed of nails can do so because the pointed nails are so close together they support rather than skewer.

If you use steel spikes, dab a little oil on the sharpened tips. This will keep them rust-free in a humid climate. Clean spikes penetrate better.

Securely fasten the two parts of the tension band to a heavy tree limb on top and an exposed root, or other lashing point, on the bottom. Both anchors will have to be very stout, or the twisting bands will slacken and lose their tension.

For the bottom lashing point, sometimes a heavy stake can be driven into the ground or the bands anchored to a large rock. However, I have never been able to find a substitute for a stout tree limb above. Anything constructed here looks artificial and suspicious and will not withstand the strain of the twist.

Construct the set in a path covered with dense underbrush. For obvious reasons the twisted bands and the club must be hidden from view.

The paddle is held back under tension by a thin trigger stick, which is tied to a light trip wire crossing the path. Mount the bands as far from the tree trunk as practical. When the paddle is wound up tight and the stick put in place, it should be positioned far enough toward the end to hold the paddle without undue pressure. At the same time, the paddle must bear on the stick enough to provide adequate trigger tension.

Butt the bottom of the trigger stick against a solid holder like a thick tree root; a stake will do in a pinch. Carefully place the stick's bottom tip against the very edge of the holder so that the slightest tug on the trip wire will release it. Whittle a couple of notches in the stick and in the holder if the trigger stick slips out easily.

Lastly, without springing the trap prematurely, string the thin trip wire across the path in final place. Anchor one end solidly to the trigger stick and the other end across the path to a stake, bush, or rock. Keep the wire taut at about boottop level, but the wire height depends on the ground cover.

If your territory is wet and you use vines or ropes for the band, check every third day or so to determine if the trap still has the band tension necessary to do the job.

Although it is nice to have wire cable and nails to

make this set, these items are not absolutely necessary. In that regard, this trap is a gem.

Another plus is the trap's simplicity. Unlike some other traps, the trigger does not tend to go bad. The entire set can be installed, if you prescout your location, in less than half an hour. You can move a Jivaro Catapult right up to the enemy's front door if you are sure you won't impale a friendly.

The Jivaro Catapult does a messy job of eliminating its victim. Everyone, friend and foe alike, will long remember the carnage it produces.

## 12. Jack the Tank Killer

A friend of mine is one of the truly outstanding mantrappers still alive today. With him, I was involved in a wildly ambitious trapping program.

This expert mantrapper was born in Kenya, East Africa, to Americanized parents also born in Kenya. His parents were what is known as second-generation missionaries. He was a lad of seventeen when the Mau Mau uprising started in Kenya. Robert Ruark may have referred to him in his book *Something of Value*.

I spent scores of nights sitting in a rondaavel listening to my friend's incredible tales about the methods and devices his band of young European counter-guerrillas used to keep the lid on the Mau Maus till the British Army arrived. By using long-distance patrols to stage vicious punitive raids, they instilled so much fear into the hearts of the enemy tribesmen they were able to limit their fatalities to fewer than eighty persons. And that's a feat no man would have thought possible when Mau Mau first flared up.

One account is still as vivid as the night he told it. That night, eight or ten of us were gathered around a small campfire—a roll of toilet paper soaked in gasoline. We were camped in the NFD area of Kenya on the Somali border. The Somali Shifta were the only native troops I ever encountered that constituted anything like

a threat. Therefore tension was high as he told the tale.

"We used some Somalis one time to clean up a band of Mau Maus," the trapper started. "The group was holed up in some deep brush up north of Thompson Falls. Five of us got up on one end. About a mile away our group of Somalis—maybe eight or ten—started in up the open valley. They were out of sight for maybe forty-five minutes when we heard a few shots. Maybe twenty minutes later the Wogs started breaking cover, running up the valley past us.

"We waited till about two-thirds had passed and then opened up. I knocked one down at about 300 yards with an American grease gun. He was the only guy that lived. Had a great bruise on his back where the slug hit him, but it didn't penetrate at that range.

"The Somalis tracked down every one we didn't get, ending the troubles in that area.

"I always thought it was like driving whitetail deer in North America," he concluded.

My friend is married now, living in the midwestern United States. For that reason, he will remain anonymous.

We operated together up on the Sudanese border during the time when the feuding between the Christians and the Moslems grew really intense. Kenya, Uganda, and Ethiopia come together in what seems on a map like just a small speck of territory. On the ground the terrain alternates between rough craggy mountains and stinking rotten lowland. The lay of the land made for tough trekking. For example, it took us several weeks just to traverse the short distance across the Kenya-Sudan frontier.

We operated in good shape for several months in Sudan. The Somali Shifta in the area were our friends. With this group on our side, there was no real danger

other than from snakes, mosquitoes, and perhaps an occasional leopard.

As is typical throughout Africa, the Bantu were lazy, unimaginative, and fearful. I never met one who could track or shoot much better than the average North American sport hunter.

Roads in that section of the world are beyond belief. Yet one day an armored personnel carrier loaded with soldiers came clanking around a mountain trail. According to the local gossip, the central government bought the outfit from Egypt and drove it south as a deterrent to our activities.

Every day thereafter, when the carrier would run, the local police drove it out in search of our little group. The noise was so great there was little danger of being surprised by it. On the other hand, we didn't dare expose ourselves for fear of running amuck of the heavy machine gun the rusty old tin can carried.

We resisted the temptation to snipe a couple of soldiers off the rear.

After a month or so of the APC's random, unchallenged coming and going, a change came over my friend, the mantrapper. He decided to get that son-of-a-bitchin' machine.

After a long and detailed search, we located a large rock about 3 meters in diameter two-thirds exposed on a steep hillside. A path wound around the hill, perhaps 500 meters below. Although the APC never traveled that road, the way was navigable.

Carefully, ever so carefully, we dug into the hill until we had excavated the rock, shoring as we went. By the time we completed excavation, all that was supporting that very large boulder was one stout beam.

In the meantime, I managed to collect enough old 1-centimeter cable to reach from the trail below to the

rock support beam above.

It took four men almost a week to haul all that rusty, trashy wire rope to the set. We cut our hands and shoulders badly on the frayed rope ends.

During all this time my friend worked on the hill—removing stones, smoothing bumps, and calculating the trajectory of the rock. He made small adjustments on the support under the rock, supposedly making its fall pinpoint-accurate.

The trigger for this monstrosity was, in my opinion, cleverly constructed. We brought in a log about 6 meters long, all of 50 centimeters through the butt. With much effort we balanced the log on end behind a large rock palisade next to the road.

Being ever so careful, we wedged rocks between the rock column and the log till it was precariously balanced on end. The log could fall outward down the slope, but not inward toward the mountain.

I connected the cable to this trigger log, leaving about 2 meters of slack, and buried it under loose earth.

A few days later we lit a fire at the end of the trail. When the fire was going strong, I threw three old tires on the flames to produce some black greasy smoke. Sure enough, within a short time the APC came rumbling out to investigate.

The carrier turned at the fork and crawled up the side trail where Jack's Tank Trap was set. We scrambled up the hill to get away.

Out of respect for the machine gun, we stayed out of sight in a little draw. However, it was possible to watch the cable tighten and the wood beam snap out from under the huge boulder above.

As planned, the vibration from the crawling APC had upset the precariously balanced log. As it fell, the log gave the cable a sharp, hard pull, yanking the wood

# ARMORED PERSONNEL CARRIER TRAP

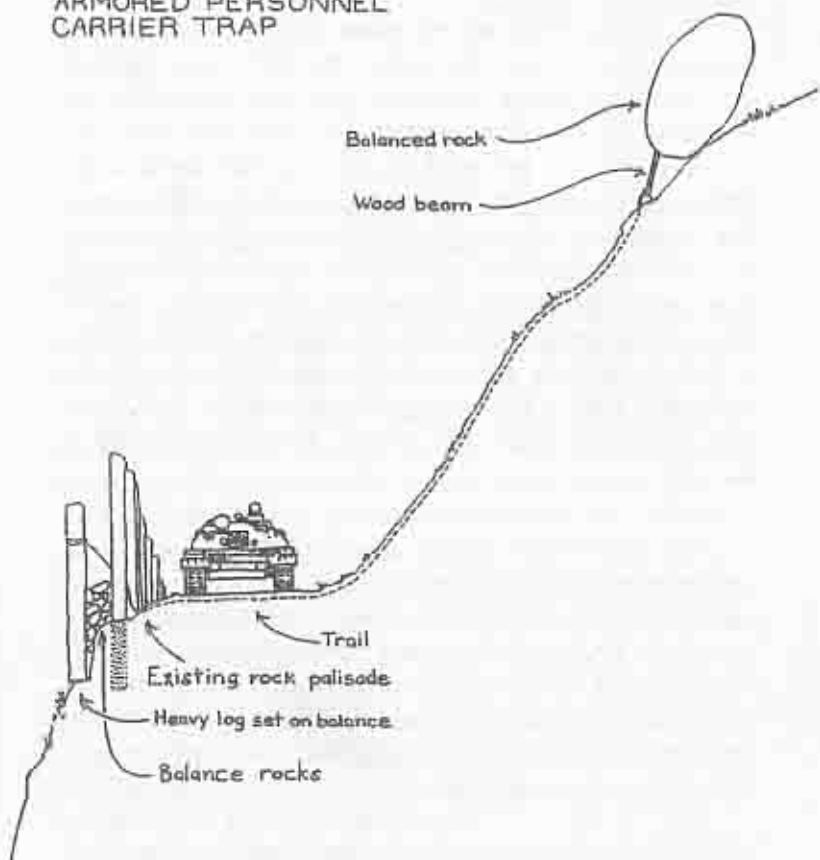



beam from under the rock.

With no shoring to stop it now, the rock started to roll. Moving slowly and ponderously at first, the rock continued to gather momentum till it rolled out of our sight below.

We heard it hit several times, on its way down the mountainside. Soon thereafter, the APC crew opened up with the heavy machine gun and several rifles shooting at the place where the rock had perched.

Next day we returned to the trap site for a look. The rock had hit the path, but missed the APC. From the appearance of the tracks, the rock fell in front of the machine. Just *how* close it fell we never discovered. The hole mark in the ground was huge—fully 1 meter deep by 3 across. Although the monster wasn't killed, it *was* scared off. When we left the region ten weeks later, the tank still hadn't dared to venture back onto that mountain. With that result, the operation was a success.

## 13. Benson's Log Snare

I have taken the liberty of concluding this book with a description of a mantrap that is of my own design.

The general concept is an adaptation of a trap that an uncle of mine, who was half-Ojibway Indian, taught me when I was a kid. Uncle used the trap in rivers and sloughs to catch mink, beaver, otter, and muskrat. Readers who have a copy of my first book, *Survival Poaching*, will recognize the design immediately.

In a larger, more powerful configuration, this contraption will trap men quite nicely. The design is especially handy as a method of protecting the approaches to one's retreat when there are narrow, wooded trails, windfalls, or other natural tangles leading to it.

Like all the mantraps in this book the Log Snare is not a particularly difficult trap to construct if the conditions are right. On the other hand, the set cannot be adapted or forced into an environment that does not include a few principal elements.

From my standpoint anyway, the greatest limitation of my Log Snare design is related to the fact that it works on the principle of crushing its victim against an overhead obstruction. To do this properly, you must entice your target into stooping under a log, or crawling along a path under a roof of logs. Enticement here is

not always that difficult to accomplish, but not that easy in some cases, either.

Another drawback is that the Log Snare requires two weights of wire to work properly. Rope or vines will not do. You must have some 12 to 14 weight and 18 weight wire for this plan. Do not even consider this mantrap if you lack the wire.

Start out by looking for a place on the trails around your territory where an overhead obstruction is forcing the pedestrian to stoop down and wiggle through. Don't forget: Americans are generally a lot larger than the average Oriental or African. Your target may be able to walk upright under a log that you have to duck for. Plan the set accordingly.

In some cases you might create the necessary environment by felling a tree across the path, or by changing a trail to go under a heavy overhanging limb or rock ledge. Cutting a tree down now for use six months later will work well but surprisingly is not always a necessary precondition.

Most mantraps do best when they are adapted to existing natural surroundings. On the other hand, humans are not as trap-wary as animals. Many of the people you target will never have patrolled in your territory before. Although they may be suspicious, they won't know if the tree over the path is recent or had been there fifty years. A well-worn trail under a tree has lured many otherwise good soldiers to their final comeuppance.

Oddly enough, city people are more reluctant to stoop under a tree than bush natives are. Folks who have been in the woods are used to ducking and twisting to get along a path. Urban soldiers are immediately suspicious.

Having found a suitable overhead obstruction, the

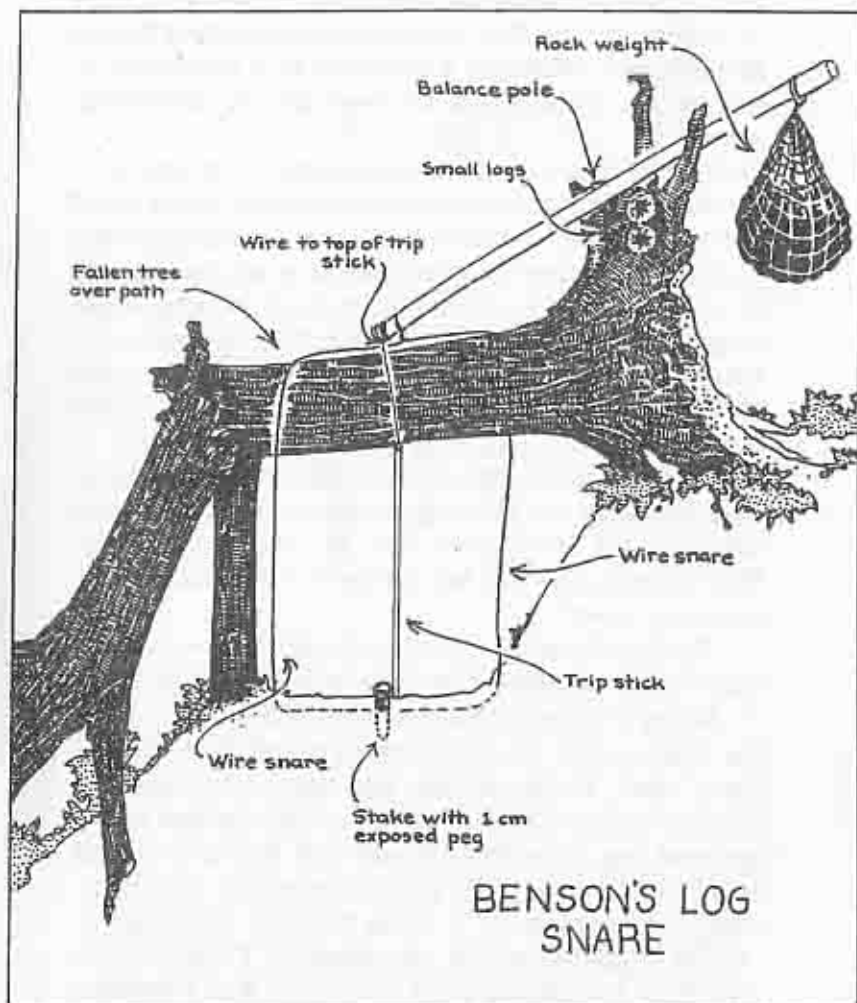

next element of the trap to locate is a suitable counterweight. Keep in mind that there are a number of ways to supply the needed energy here. In some places a dropping log will work. Another set may best be made using a bent tree, or even a balance pole for the energy source.

For the purposes of this explanation, I am going to use a balance pole, as seen in the diagram. This method is not necessarily the best, but I haven't suggested using it any other place in the book. A good mantrapper should know how to use balance poles. No matter which energy source you use, remember that this particular mantrap requires a method that will store a huge amount of energy, more so than any other trap in this book.

Set up a heavy balance pole and weight it with at least 500 kilos of rocks. If not rocks, use a heavy log and stack on more heavy logs for additional weight. When sprung, this trap has to snap shut with devastating speed and power.

The balance pole and counterweights are, as with all other traps, screened from view with brush and limbs.

String a piece of Number 18 wire from the end of the balance pole to a thin, strong trigger stick. Drive a heavy stake almost all the way into the ground and butt the trigger stake against it and the bottom of the overhead log. The stick should look like it is leaning against the log. By hiding the wire behind the trigger stick, the problem of it being seen can be mitigated.

The trigger should be very sensitive. Tension on the wire must be maintained almost to the wire's breaking point.

The killer section of the Log Snare is made of Number 12 or 14 wire. Don't use Number 9 wire. It is too heavy to cut and may just bruise the quarry rather

than cutting and killing. If you can scrounge it, four-point barb works reasonably well, especially the thin, ductile variety made in Japan.

Shape the wire in a box a bit wider than the trail itself, below the balance pole. Bury the bottom section of the wire in the path and hide the sides in the grass.

When the enemy nudges the trigger stick, the balance pole will release, strongly springing the wire up tight against the overhead log where it stops. This action has been known to break necks and shoulders, or even crush enemy chests.

Obviously this mantrap will work best at night, which is not all bad. People seem more inclined to sneak around under logs at night.

Having found a suitable location, two men can install Benson's Log Snare in half a day. There is not a lot of fuss with this one and the trap *is* effective, especially on the first catch.

## Conclusion

Currently, self-proclaimed doomsayers are predicting the imminent collapse of American society as we know it today. I can't say that I totally concur with this viewpoint, but do believe that such a downfall is quite possible. The main difference here is that I think our sick economic system would be the most likely cause of mass social turmoil and ensuing anarchy.

Should this ever occur, retreaters and other survivors may want to use the systems described herein to protect their territories. The tactical-defensive possibilities are obvious.

If we are ever involved in another international war—and I think we will be eventually—then many readers will undoubtedly end up fighting overseas in some God-forsaken stinkhole where people still practice the art of trapping other humans. At this future date, staying out from underneath your enemy's chopper log will become a matter of life and death. So remember these lessons well, particularly if you are of conscription age.

One final matter brings itself to mind. As far as I know, no other book exclusively about mantrapping has ever been published anywhere in the world. I firmly believe that folks like myself have an obligation to leave a permanent record about such rare information for use

by future historians, anthropologists, and tacticians; but also to serve as a guide for ill-prepared, urbanized survivors who may have to face a brave new world.