

# TUTORIAL: MILITARY MEMETICS

**Presented By:**

**Dr. Robert Finkelstein**

**President, Robotic Technology Inc.**

**BobF@RoboticTechnologyInc.com**

**Phone: 301-983-4194 ; Fax: 301-983-3921**

**Collegiate Professor**

**Graduate School Of Management and Technology**

**University of Maryland University College**



**Presented At:**

**Social Media for Defense Summit**

**Alexandria, Virginia**

**24- 26 October 2011**



**This presentation is based on projects Robotic Technology Inc. performed for the Defense Advanced Research Projects Agency (DARPA), 2006-2009, and we thank DARPA for their vision and support**



# EXECUTIVE SUMMARY: MOTIVATION

- The “long war” against terrorism and the ongoing conflicts with asymmetric adversaries are, fundamentally, wars of ideas
- **We are losing the war of ideas**
  - *“We are in an information war, and we're losing that war.”* -- Secretary of State Hillary Clinton
  - *“[Our enemy] has said that 50 percent of the current struggle is taking place in the arena of public information. That may be an understatement.”* -- Secretary of Defense Donald Rumsfeld
  - *“Challenge disinformation. Turn our enemies’ extremist ideologies, oppressive practices, and indiscriminate violence against them.”* -- Gen. David Petraeus, issuing guidelines for an aggressive information war in Afghanistan
  - *“The other half [of the battle] is the arena of ideas, and countering the rhetoric and methods that extremists use to recruit.”* -- Ali H. Soufan, FBI Al Qaeda interrogator









# EXECUTIVE SUMMARY: MEME ASPECTS

- **Example memes:** words, ideas, symbols, icons, logos, tunes, poems, catch-phrases, fashion, technological processes (e.g., making arrowheads or gumbo), fables, religion, graffiti, images, novels, movies, narratives, culture (functional or dysfunctional; national, tribal, or organizational)
- **Memes can be described by their external phenomena (e-memes) and internal phenomena (i-memes)**
- **E-memes are manifested by their effects on human behavior and culture**
- **I-memes are manifested by their effects on an individual's neuronal behavior and brain**
- **E-memes and i-memes are not two types of memes, but rather two effects or manifestations of memes**

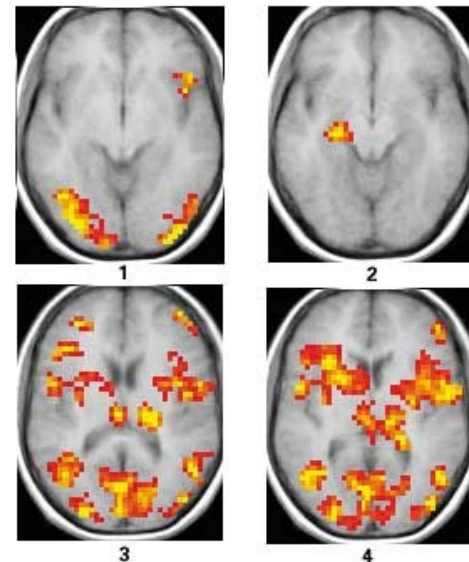

# EXECUTIVE SUMMARY: E-MEMES

- The tools and techniques for studying both manifestations of memes differ
- **E-memes can be studied via their simulated or actual propagation over social networks (modern social media are especially efficient and effective for propagating memes)**
  - Tools and techniques include: Internet and phone text and voice message propagation; rumor and gossip propagation; buzz and viral marketing
  - Also neuroeconomics behavioral experiments involving: game theory, risk, attention and awareness, learning, valuation, motivation, emotion, behavior, trust and attachment, and addictive behavior

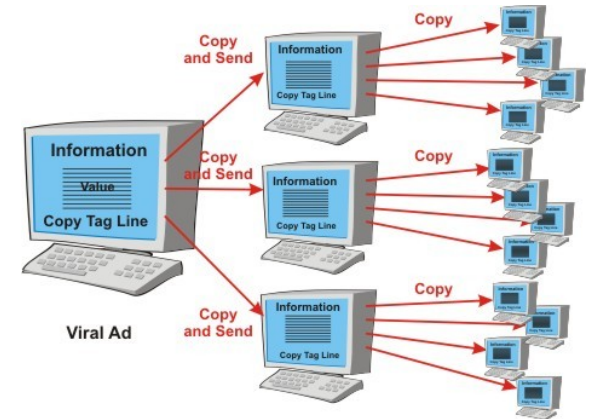

# EXECUTIVE SUMMARY: I-MEMES

- I-memes can be studied using tools and techniques such as:
  - Functional magnetic resonance imaging (fMRI) or other kinds of neuro-imaging; genetic profiling; psycho-pharmacological manipulations; psycho-physiology (EMG, ERP, and EEG); behavioral measures; psychological testing; blood chemistry; hormone analysis; and neuro-chemical reactions; and single neuron recording
- The study of both aspects of memes must be integrated with a synthesis of the phenomena and the multi-disciplinary study of the phenomena

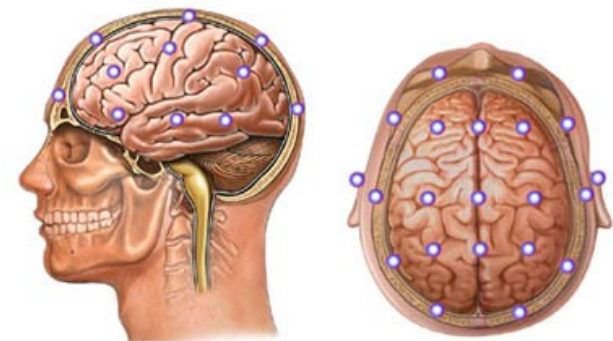



# EXECUTIVE SUMMARY: MEME ORIGIN

- The word “meme” is a neologism coined by Richard Dawkins in “The Selfish Gene” (1976), (although it may have had earlier roots)
- **Dawkins defined it as a self-reproducing and propagating information structure analogous to a gene in biology**
  - He focused on the meme as a replicator, analogous to the gene, able to affect human evolution through the evolutionary algorithm of variation, replication, and differential fitness
  - **The meme had evolutionary effects on human culture and physiology**
- **A meme’s information structure can have many forms, including**
  - **Words, symbols, images, icons, artifacts**
  - **The information content of a meme can be concise, middling, or lengthy**

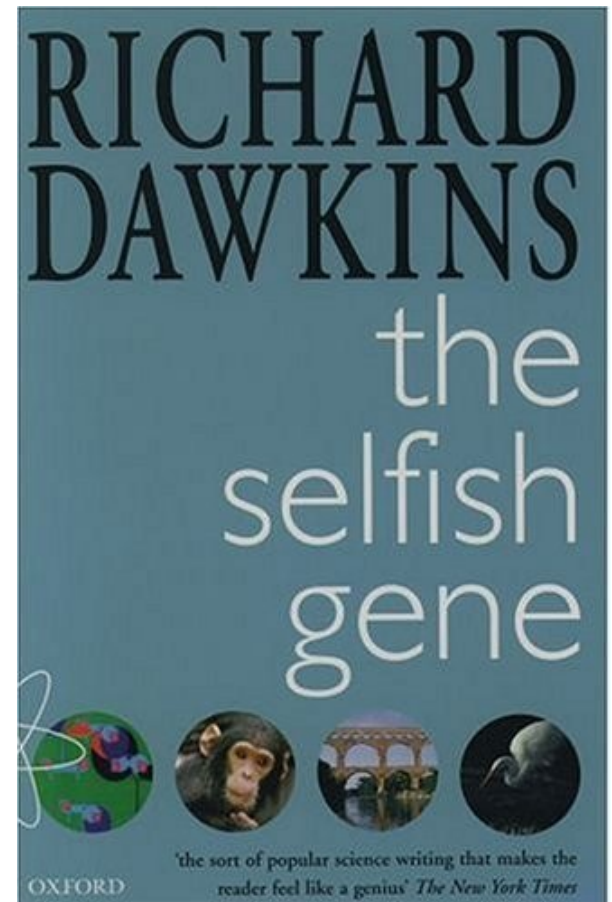

# EXECUTIVE SUMMARY: MILITARY MEMETICS

- For national security applications (Military Memetics), most memes of interest are concise (e.g., 1-10 words) or middling (e.g., 10 words – 10 pages), for optimum propagation over social media
- **The meme definition for Military Memetics is: information which propagates, has impact, and persists (Info-PIP)**
  - Where metrics can be defined and evaluated for the variables of information, propagation, and persistence
- **The desired impacts of memes for national security are immediate, not evolutionary**
  - Memes can change individual and group values and behavior
  - Memes can enhance dysfunctional cultures or sub-cultures



# EXECUTIVE SUMMARY: MEMETICS RESEARCH

- In the decades since 1976, research on memes has been scattered and unfocused, limited largely to individual academics
  - As part of our Military Memetics project, we prepared a 1680-page Compendium to provide a broad overview of memetics based on a variety of papers by various authors
  - We also prepared a 37-page Excerpts of the Compendium containing its highlights
- The Defense Advanced Projects Research Agency (DARPA) has supported a series of memetics-related projects with multidisciplinary teams from industry and academia
  - Epidemiology of Ideas (2006)
  - Military Memetics (2006-2009)
  - Social Media in Strategic Communications (SMISC) (2011-in progress)
  - Narrative Networks (N2) (2011-in progress)

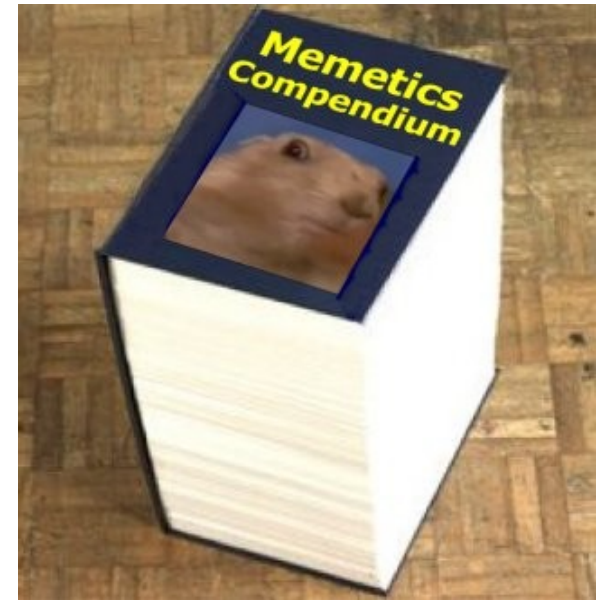



# EXECUTIVE SUMMARY: DARPA MEMETICS RELATED RESEARCH

- **Epidemiology of Ideas (DSO, 2006)**
  - To predict changing culture and examine the creation, propagation, and impact of ideas
- **Military Memetics (DSO, 2006-2009)**
  - To determine whether memetics can be established as a science with the ability to explain and predict phenomena; to define memes and memetic metrics; and to use tools and techniques (e.g., fMRI and social network simulations) to examine Info-PIP
- **Social Media in Strategic Communications (SMISC) (I2O, 2011-in progress)**
  - To develop automatic tools and techniques for detecting, identifying, evaluating, and countering adversarial memes
- **Narrative Networks (N2) (DSO, 2011-in progress)**
  - To perform quantitative analysis of narratives, understanding their effects on human psychology and neurobiology, and determine their influence on individuals and culture

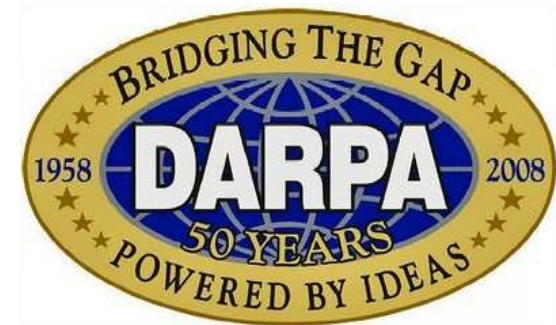

# PURPOSE OF A MILITARY MEMETICS PROGRAM

- To develop a new approach to
  - **Countering terrorists and insurgents *before* and *after* they become terrorists and insurgents: influencing beliefs in a scientific way**
  - **Preventing or mitigate irrational conflict and promoting rational solutions to national and international problems**
  - **Strengthening the U.S. military in**
    - **Peacekeeping missions**
    - **Psychological operations**
    - **Recruitment**
    - **Training**
- **To make new discoveries concerning the human brain, cognition, and social networks**

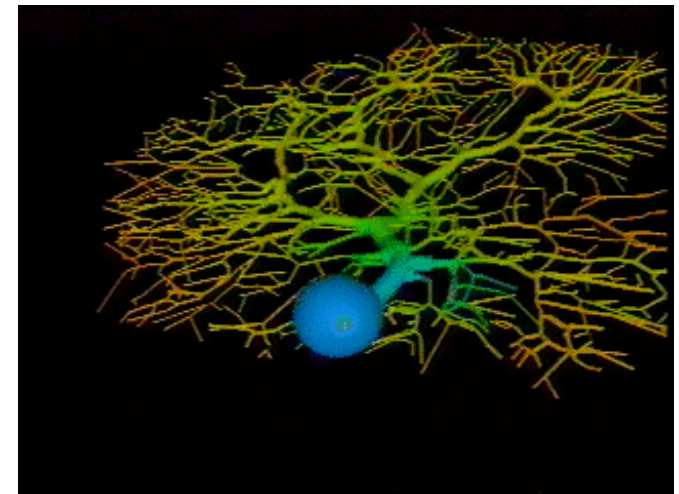
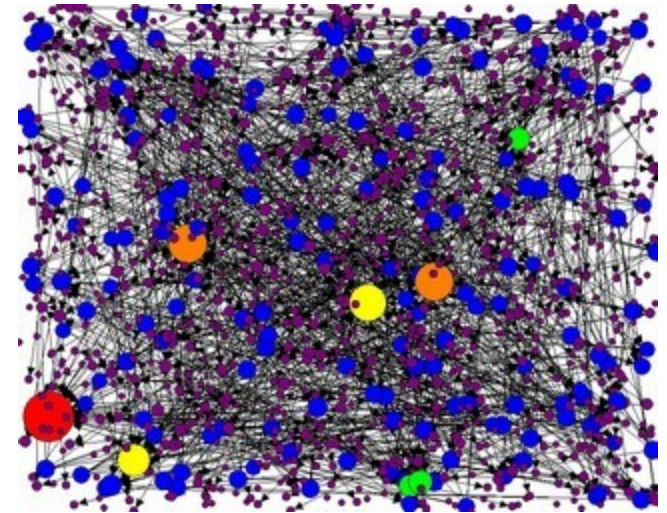

# MILITARY MEMETICS CONGRUENT WITH NOTION OF EPIDEMIOLOGY OF IDEAS

- The “long war” against terrorism is, fundamentally, a *war of ideas*
  - “Today the centers of gravity of the conflict in Iraq and the global war on terror are not on the battlefields overseas. Rather, the center of gravity of this war are on the centers of public opinion in the U.S. and in the capitals of free nations. The gateways to those centers are the international media hubs and the capitals of the world. **Zawahiri** has said that 50 percent of the current struggle is taking place in the arena of public information. That may be an understatement. **Osama bin Laden, Zawahiri, Zarqawi** had media committees that consistently outpace our ability to respond.” [Secretary of Defense Donald H. Rumsfeld, “*Illustrative New 21<sup>st</sup> Century Institutions and Approaches*,” Secret Memorandum, 1 May 06, as quoted by Bob Woodward, *Washington Post*, 8 Oct. 06, P. B5]





# MILITARY MEMETICS CONGRUENT WITH NOTION OF EPIDEMIOLOGY OF IDEAS

- **DARPA and the Defense Sciences Research Council (DSRC) held workshops on the Epidemiology of Ideas**
- **Goals of Epidemiology of Ideas**
  - **Ability to predict changing cultural values**
  - **Identify techniques to assure propagation of an idea**
  - **Identify who is vulnerable to a propagating idea**
  - **Determine characteristics of networks that facilitate spread of ideas**
  - **Predict the consequences of propagating an idea**

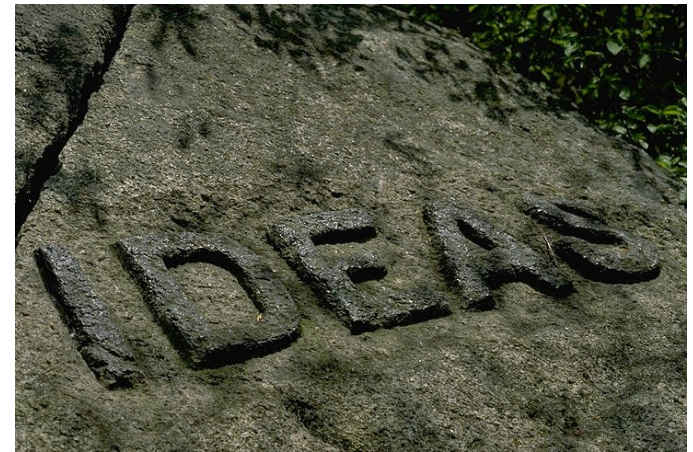

# MILITARY MEMETICS CONGRUENT WITH NOTION OF EPIDEMIOLOGY OF IDEAS

- DARPA/DSRC Workshop definition (characterization) of *idea* similar to concept of *meme*
- Epidemiology of ideas a function of biology, culture, and communications
  - **Biology:** knowledge of brain – fMRI, neurochemical reactions (e.g., dopamine, oxytocin)
  - **Culture:** cultural values, linguistics, demographic market segmentation buzz (i.e., viral) marketing
  - **Communications:** network models, cyberspace jihad, smart mobs via texting

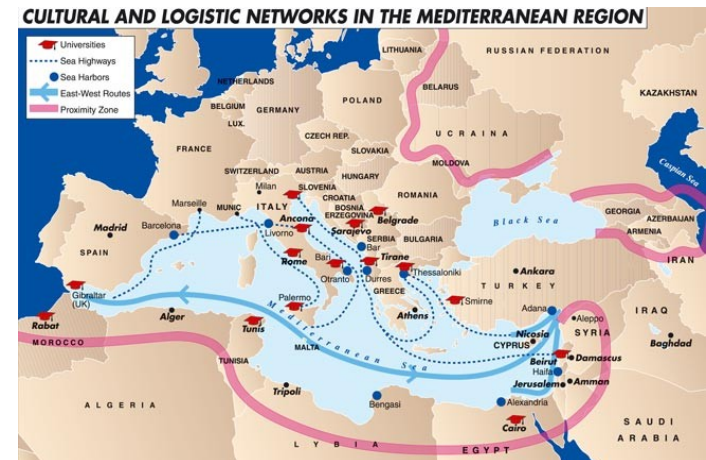
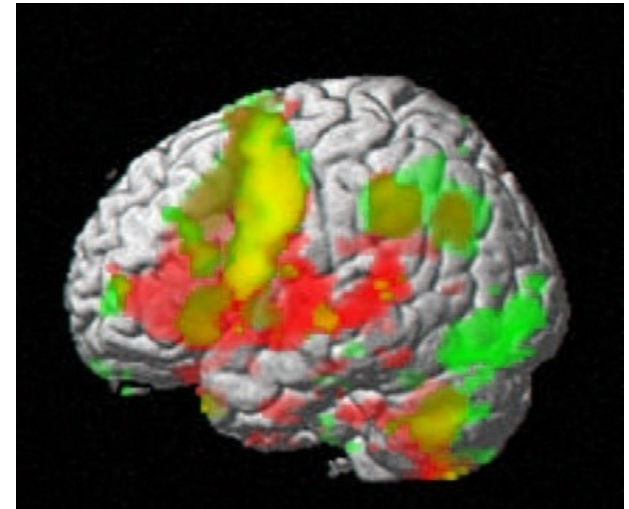

# EARLY CONCEPT OF THE MEME

## Meme (Dawkins's Concept):

- **Self-reproducing and propagating information structures analogous to genes in biology**
  - **Able to replicate using hosts and to influence behavior to promote replication**
- **Mneme (Pre-Dawkins)**
  - **Notion of a unit of social evolution**
  - **Transliteration of the Greek word**
  - **Introduced (1904) by German evolutionary biologist Richard Semon in *Die Mnemische Empfindungen in ihren Beziehungen zu den Originalenempfindungen* (English translation 1921)**
- **Analogous to Darwinian natural selection**
  - **A unit of cultural inheritance**
  - **Alters individual (psychological) and group (sociological) behavior – and ultimately evolution of the species**

***Memes and genes may have cooperative or adversarial relationships***



**Becoming mainstream:** “Witness the explosion of a new **hip-hop meme** into white culture,” *Picking Up the Lyric but Missing the Beat*, *Washington Post*, Tuesday, March 7, 2006; P. C01





# RELEVANT MEME PROPERTIES

- For the purposes of national defense, the relevant and important characteristics of the meme are its ability to:
  - Propagate
  - Influence behavior (i.e., have impact)
  - Persist
- Exclude from consideration:
  - Evolutionary effects
  - Genetic relationships
- The meme will be examined as a type of culturally transmitted information
  - Variables of propagation, influence, and persistence, defined to achieve military worth

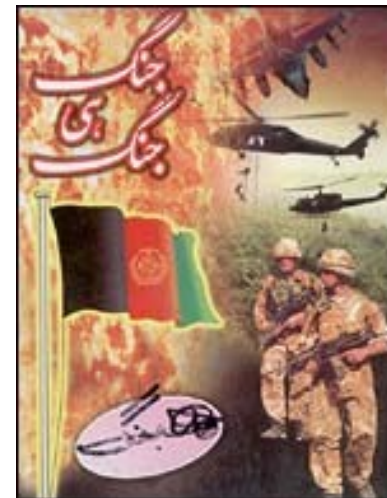

# MEMETICS AS A SCIENTIFIC DISCIPLINE

- **Since Dawkins' revelation**
  - **Coterie of proponents, skeptics, opponents**
  - **Few coherent, well-funded, significant R&D projects of concept**
  - **No refutation**
- **Memetics needs**
  - **A general theory – a theoretical foundation for development of a scientific discipline, not pseudo-science**
  - **Better focus, pragmatic definition**
  - **Ability to make testable predictions & falsifiable hypotheses**

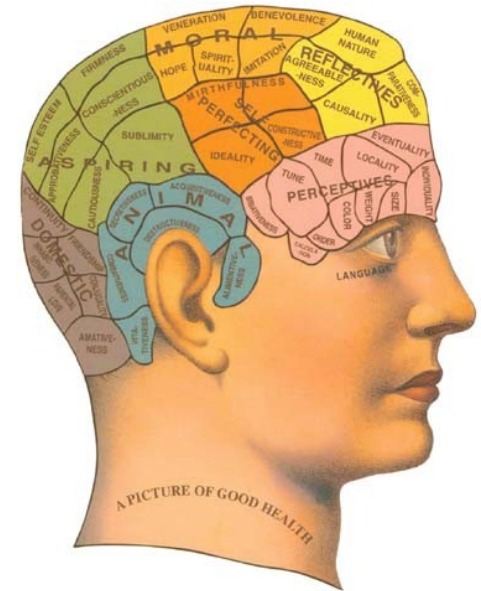

# MEMETICS AS A SCIENTIFIC DISCIPLINE

- The discrete meme must be defined, identified, and distinguished in the near-continuum of information
  - Just as the discrete gene can be identified (more or less) in long string of DNA nucleotides
- Quantitative basis for memes must be established, e.g.,
  - Physiological effects
  - Information theory and entropy
  - Genetic, memetic, and evolutionary algorithms
  - Modeling and simulation
  - Neuroeconomics tools

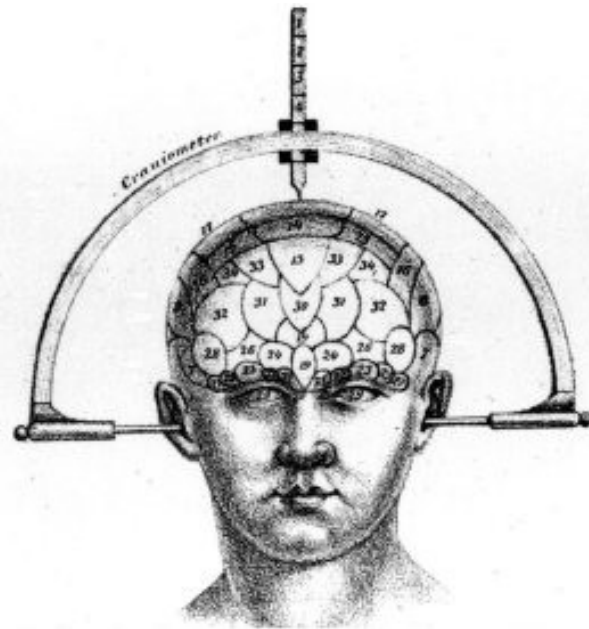

# WHY DEFINE MEMES?

- Some say a crisp definition of “unit of information” or “unit of cultural transmission” is not critical to a theory of memes
  - E.g., Darwin’s Theory of Evolution was scientifically useful before anyone knew about genes and DNA
- But a pragmatic definition and associated metrics would provide a better foundation for research and the ability to make testable predictions and falsifiable hypotheses, and control effects
  - Which DNA and genetic engineering now provides to Darwin’s Theory
  - Memetic engineering or applied memetics

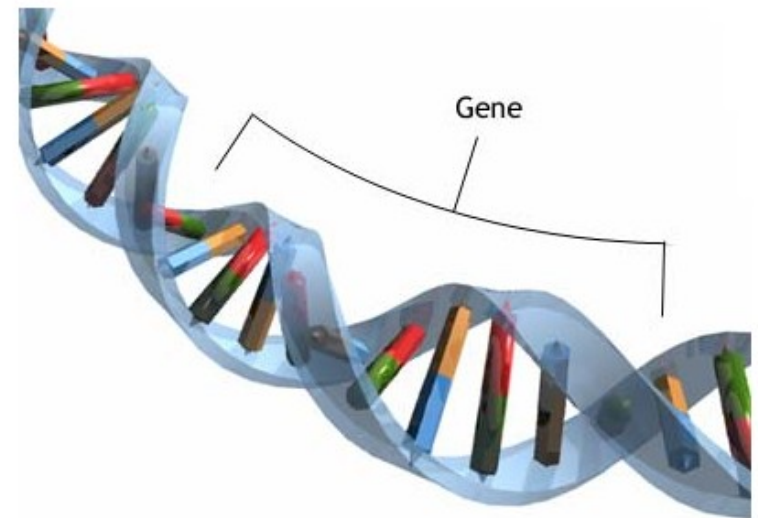
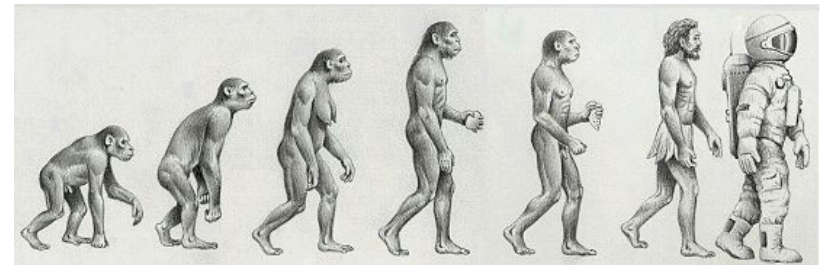



# WHY DEFINE MEMES?

- **Darwin's Theory of Evolution was scientifically useful before anyone knew about genes and DNA**
  - **Because Darwin and other scientists had physical objects (e.g., fossils or living physiological structures) to measure**
  - **Metrics existed with which to compare and contrast entities**
  - **A coherent theory could be developed in which phenomena can be quantified and predicted**
- **This is *not* the case for Memes**
  - **There is not an analogous Theory of Memetics**

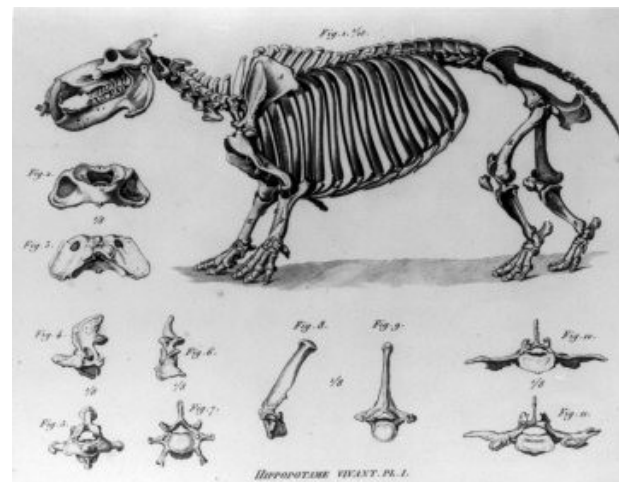

# EXTANT MEME DEFINITIONS

- Extensive memetics literature reveals a plethora of definitions for the meme, with most being variations of Dawkins original notion
  - Most agree that a meme is a unit (whatever that means) of cultural transmission (or a unit of information - whatever that means), where culture may be defined as the total pattern of behavior (and its products) of a population of agents, embodied in thought, behavior, and artifacts, and dependent upon the capacity for learning and transmitting knowledge to succeeding generations
  - None of these definitions is sufficient to allow a meme to be clearly recognized or measured

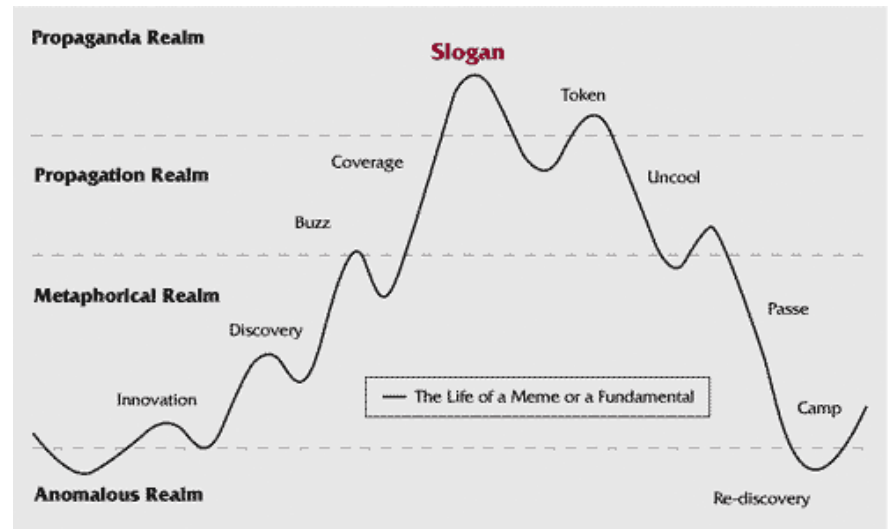
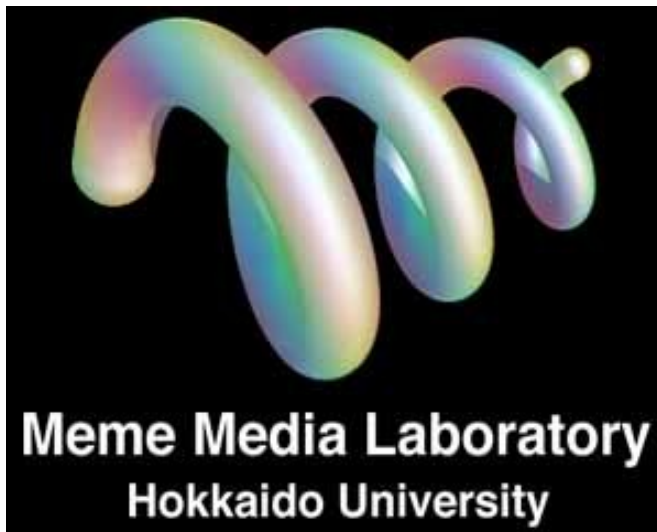

# EXAMPLE EXTANT MEME DEFINITIONS

- **A self-reproducing and propagating information structure analogous to a gene in biology**
- **A unit of cultural transmission (or a unit of imitation) that is a replicator that propagates themselves in the meme pool leaping from brain to brain via (in a broad sense) imitation; examples: “tunes, ideas, catch-phrases, clothes fashions, ways of making pots or of building arches”**
- **Ideas that program for their own retransmission or propagation**
- **Actively contagious idea or thought**
- **Shared elements of a culture learned through imitation from others – with culture being defined rather broadly to include ideas, behaviors, and physical objects**



# EXAMPLE EXTANT MEME DEFINITIONS

- An element of a culture that may be considered to be passed on by non-genetic means, especially imitation
- **Whatever is passed on by imitation**
- Constellations of activated and non-activated synapses within neural memory networks
- **Information patterns infecting human minds**
- While the internal meme is equivalent to the genotype, its expression in behavior (or the way it affects things in its environment) is its phenotype



**Meme: "It Ain't Over 'Till The Fat Lady Sings"**



# EXAMPLE EXTANT MEME DEFINITIONS

- Any information that is copied from person to person or between books, computers, or other storage devices
  - Many mental contents are not memes because they are not acquired by imitation or copying, including perceptions, visual memories, and emotional feelings; skills or knowledge acquired by ordinary learning are not memes
- A unit of cultural information; a piece of knowledge, an idea [with an anchor, carrier, and payload]
- **Biological Definition:** Basic unit of cultural transmission, or imitation
- **Psychological definition:** The unit of cultural heredity analogous to the gene; the internal representation of knowledge

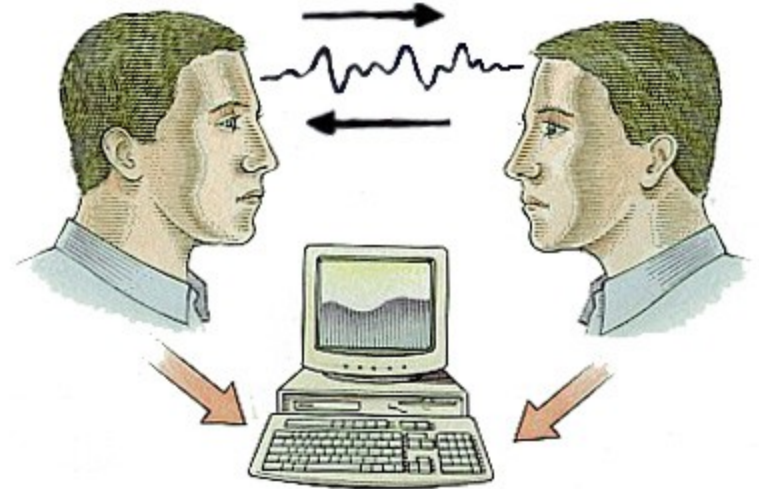

# EXAMPLE EXTANT MEME DEFINITIONS

- **Cognitive definition:** An idea, the kind of complex idea that forms itself into a distinctive memorable unit, spread by vehicles that are physical manifestations of the meme
- **Working definition:** A unit of information in a mind whose existence influences events such that more copies of itself get created in other minds
- A memory item, or portion of an organisms neurally-stored information, identified using the abstraction system of the observer, whose instantiation depended critically on causation by prior instantiation of the same memory item in one or more other organisms' nervous systems

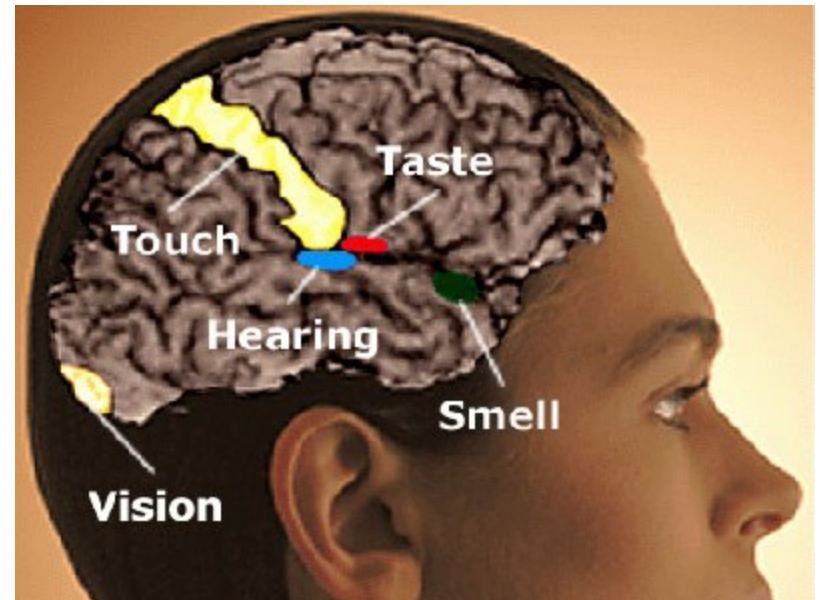
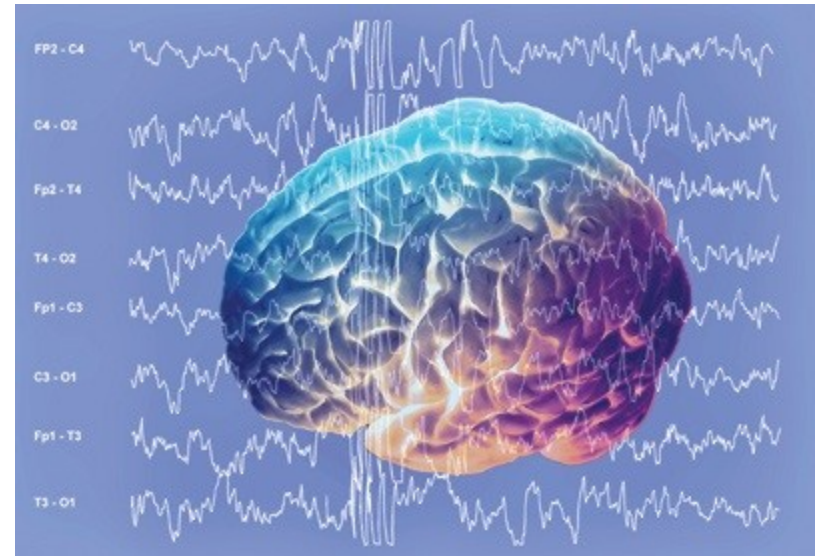

# EXAMPLE EXTANT MEME DEFINITIONS

- **A heterogeneous class of entities, primarily including (observable) behavior and artifacts**
- **An element of culture that may be considered to be passed on by non-genetic means, especially imitation**
- **The least unit of socio-cultural information relative to a selection process that has favorable or unfavorable selection bias that exceeds its endogenous tendency to change**

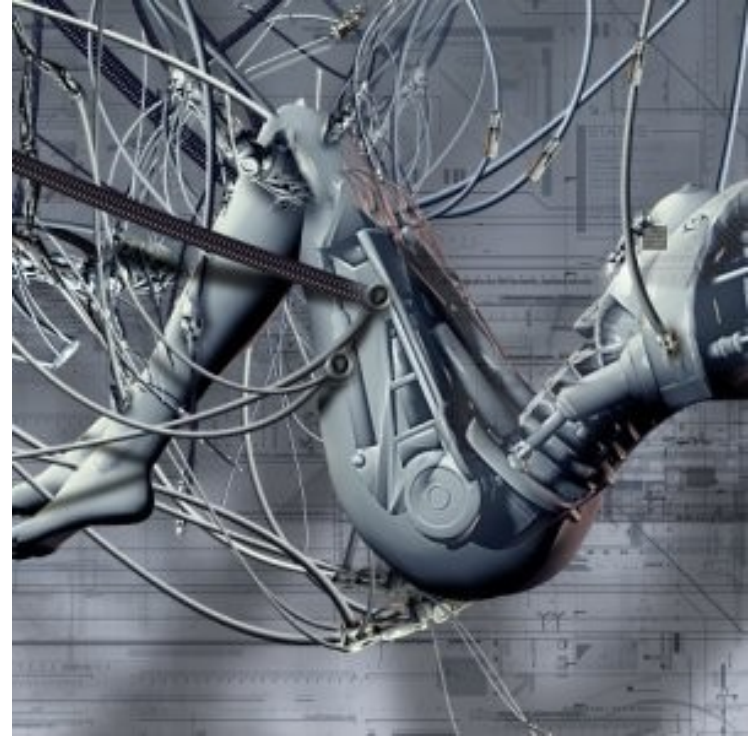



# EXAMPLE EXTANT MEME DEFINITIONS

- **Cultural replicators propagated through imitation, undergoing a process of selection, and standing to be selected not because they benefit their human carriers, but because they benefit themselves**
- **A symbolic representation of any state of affairs, either internal and implemented in the mind or external implemented in an external (non-mental) objects such as artifacts, products, behaviors**
- **Replicating conceptual units – the largest reliably replicating unit within our text corpus**
- **A (cognitive) information-structure able to replicate using human hosts and to influence their behavior to promote replication**

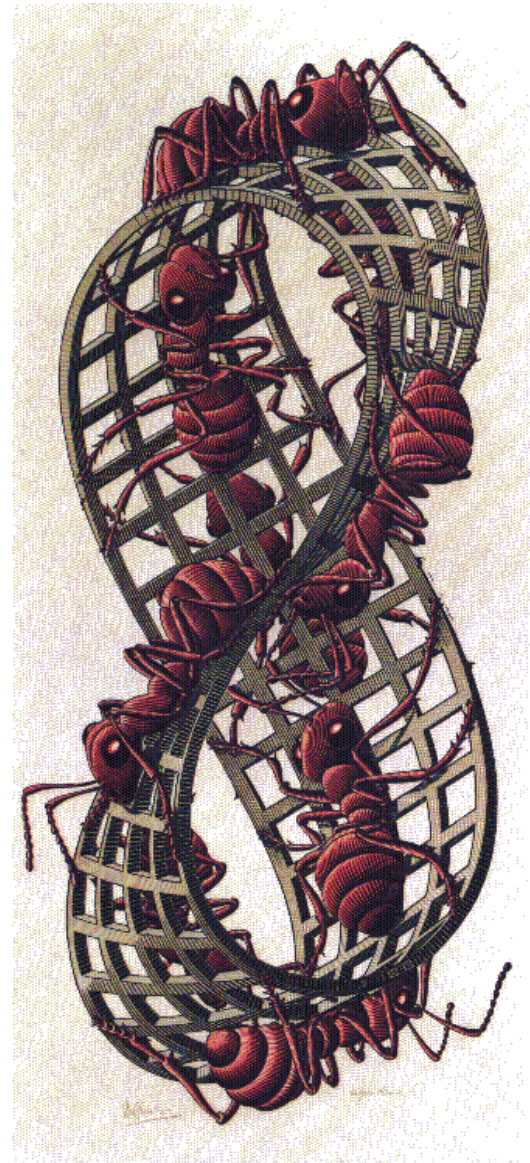



# EXAMPLE EXTANT MEME DEFINITIONS

- Cultural information units that are the smallest elements that replicate themselves with reliability and fecundity
- **A rule of behavior, encoded by functional neuronal groups or pathways.** [Behavior is action, whether mental or physical. Ideas such as *tying shoe-laces* or *opening a door* represent rules of physical action, i.e., rules of patterned neural-muscular interaction. Concepts such as *apple*, *seven*, or *causality*, represent rules of mental action, or rules of cognition, i.e., rules of patterned neural-neural interaction. Hence, physical movement is governed by memes which represent rules of physical action and thought is governed by memes which represent rules of mental action]







# EXAMPLE EXTANT MEME DEFINITIONS

- **A unit of information residing in a brain**
- **An observable cultural phenomenon, such as a behavior, artifact or an objective piece of information, which is copied, imitated or learned, and thus may replicate within a cultural system. Objective information includes instructions, norms, rules, institutions and social practices provided they are observable**
- **A pattern of information, one that happens to have evolved a form which induces people to repeat that pattern**



# EXAMPLE EXTANT MEME DEFINITIONS

- A contagious information pattern that replicates by parasitically infecting human minds and altering their behavior, causing them to propagate the pattern. Individual slogans, catch-phrases, melodies, icons, inventions, and fashions are typical memes. An idea or information pattern is not a meme until it causes someone to replicate it, to repeat it to someone else. All transmitted knowledge is memetic
- The smallest idea that can copy itself while remaining self contained and intact ... essentially sets of instructions that can be followed to produce behavior. Instructions can be encoded in either: 1) musical notation; 2) written text; 3) visible (or vocal) action; 4) the neural structure of the brain; 5) digitized structures in a computer
- The least unit of socio-cultural information relative to a selection process that has favorable or unfavorable selection bias that exceeds its endogenous tendency to change

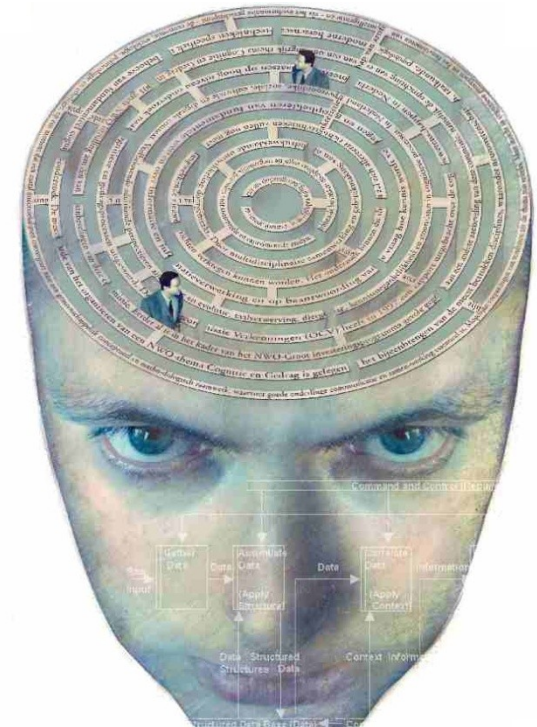
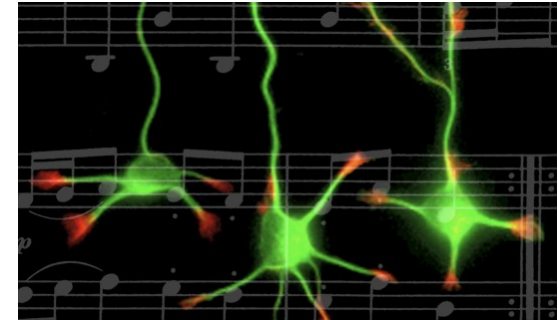



# OUR PRAGMATIC DEFINITION OF MEME

- We created a pragmatic definition of a meme
  - To elicit comments and improvements
  - Eventually converge to a canonical definition that will be useful in establishing a scientific basis for memetics

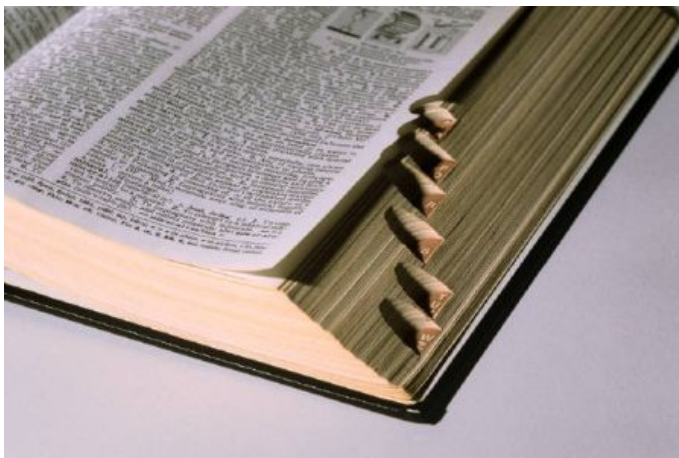

# OUR PRAGMATIC DEFINITION OF MEME

The concise version:

➤ **A meme is information which propagates, has impact, and persists**

We will elaborate on this definition

And we will elaborate on the meanings of the terms of this definition:  
*information, propagation, impact, and persistence*

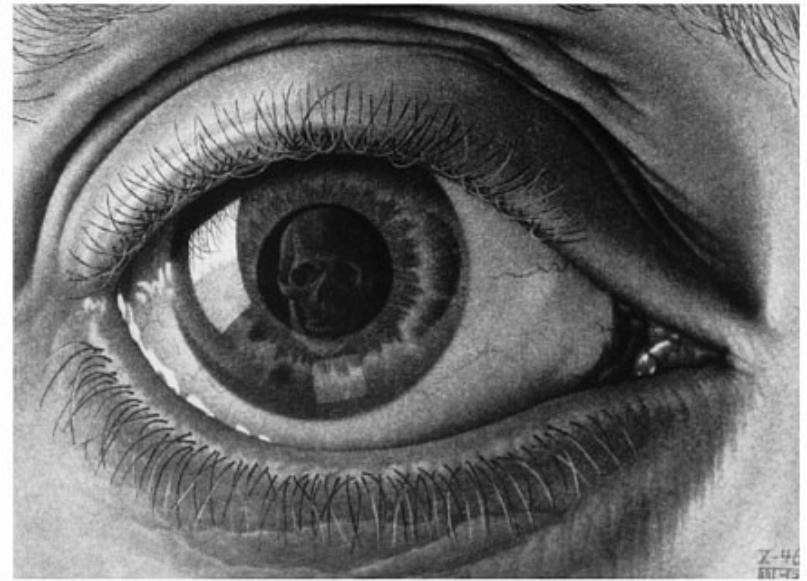
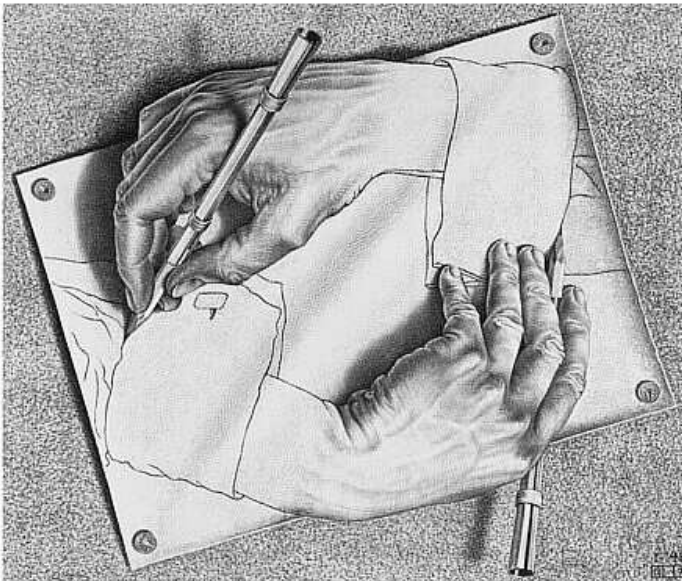

# ELABORATING ON OUR DEFINITION OF THE MEME

- A meme is information (using Shannon's definition as that which reduces uncertainty) transmitted by one or more primary sources to recipients who, as secondary sources, retransmit the information to *at least* an order of magnitude more recipients than primary sources, where propagation or the information persist *at least* ten hours and the information has observable impact in addition to its transmission
  - To distinguish a meme from other sorts of information (e.g., from common daily utterances), we invoke an **order of magnitude rule** and place an emphasis on the necessity of a **threshold for propagation and persistence**





# OUR PRAGMATIC DEFINITION OF MEME: EXPLANATION

- **Information:** Claude Shannon's definition: information is that which reduces uncertainty
  - The difference between two states of uncertainty before and after a message has been received
  - A message carries information inasmuch as it conveys something not already known
  - The same message can have different influence or impacts, depending on the states of the recipients; a meme, as a subset of information, could have different consequences for different recipients

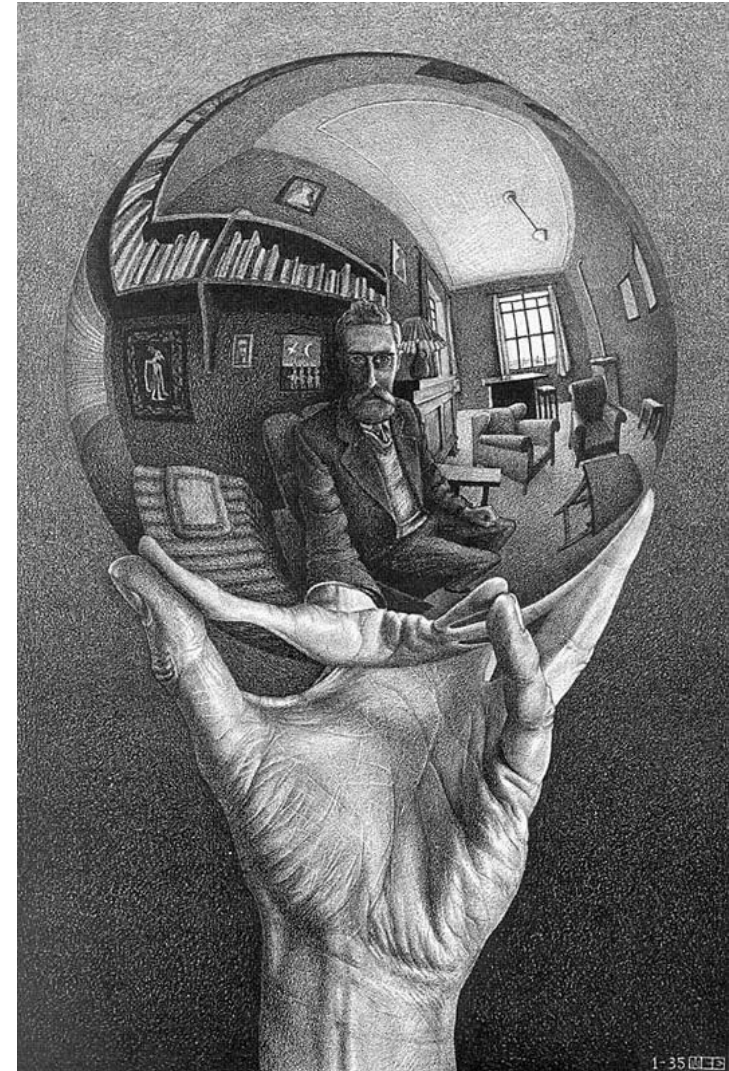



# OUR PRAGMATIC DEFINITION OF MEME: EXPLANATION

- **Transmitted by one or more primary sources**
  - **A primary source either originates a new, original meme, or a variation of an existing meme, or resuscitates a previous meme (e.g., one that has been dormant or otherwise unknown to the current recipients)**
  - **A single primary source can be sufficient for a meme (and is usually the case for original memes)**
  - **Because communication is now inexpensive, a single primary source can transmit the meme to hundreds or thousands of recipients**
  - **A group may also originate a meme, and one or more members of the group may then transmit the meme to any number of recipients**



# OUR PRAGMATIC DEFINITION OF MEME: EXPLANATION

- Transmitted to recipients who, as secondary sources, retransmit the information to *at least* an order of magnitude more recipients than primary sources
  - At a minimum, if there is one primary source, then there must be at least 10 recipients of the meme when it is re-transmitted by one or more secondary sources (i.e., initial recipients)
  - While “10” is an arbitrary number, as an order of magnitude increment (at a minimum) it serves a filter to distinguish memes from ordinary discourse
  - The requirement that a meme be re-transmitted in at least one cycle also serves as filter to distinguish memes from non-memes



# OUR PRAGMATIC DEFINITION OF MEME: EXPLANATION

- **Where propagation and/or the information persists *at least ten hours***
  - **As another constraint to distinguish memes from ordinary discourse, at a minimum, the meme must be transmitted (e.g., constant emailing or text messaging or hits on a website) over a period of 10 hours or persist (e.g., in a file or on a website or in memory) for at least 10 hours**
  - **The 10-hour minimum applies to either propagation or persistence or as a minimum total for both**
  - **While 10 hours is arbitrary, it serves as a minimal propagation and persistence filter**





# OUR PRAGMATIC DEFINITION OF MEME: EXPLANATION

- The information has observable impact in addition to its transmission
  - Information may be ascribed to have impact from the act of transmitting or re-transmitting it - but our definition requires additional kinds of impact
  - Impact might be evidenced, for example, as identifiable neuronal patterns in the brain or other physiological effects in individuals, or as resulting behavior in an individual or a group of individuals
  - The significance (or degree) of the impact may be determined objectively or subjectively or a combination of methods

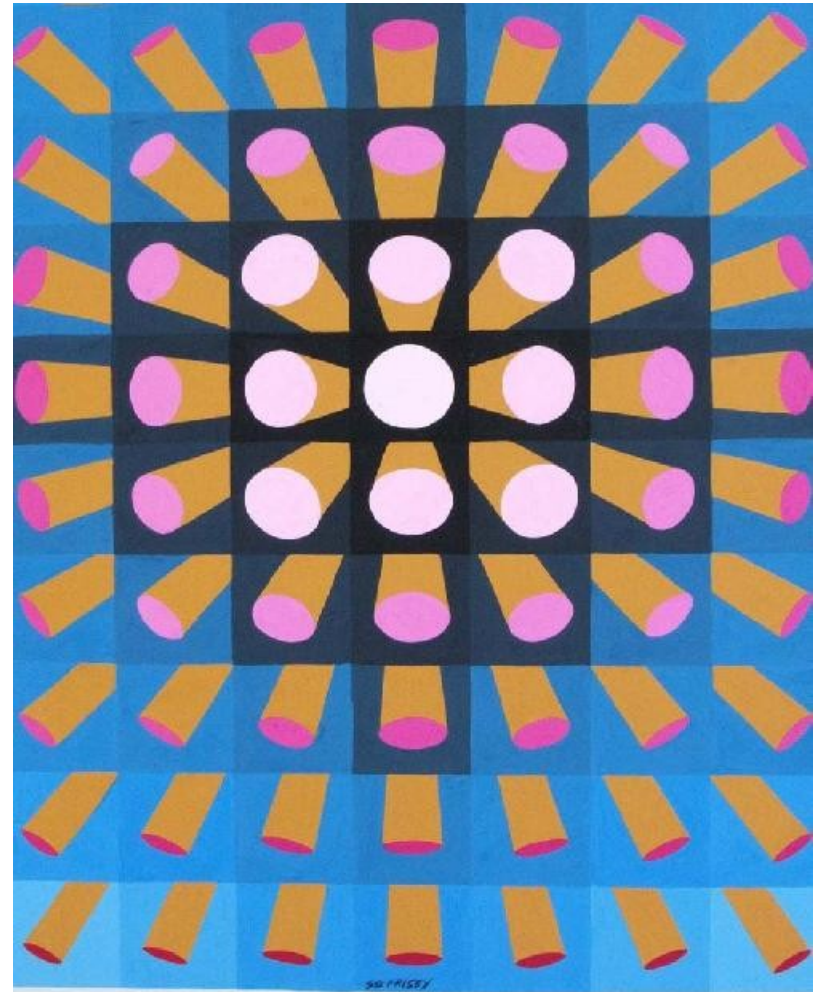



# OUR PRAGMATIC DEFINITION OF MEME: EXPLANATION

- **Our definition of the meme has metrics contained within it, to distinguish memes from non-memes**
- **In addition, we defined metrics and submetrics so that memes can be evaluated against each other, to**
  - **(1) Estimate which prospective meme might be preferable for a particular application**
  - **(2) Examine why some memes are more successful than others**
  - **While (1) requires that the values of the metrics and submetrics be estimated, (2) requires that the values be obtained as measured data**



# MEMETIC METRICS AND SUBMETRICS

We defined metrics and submetrics for evaluating memes

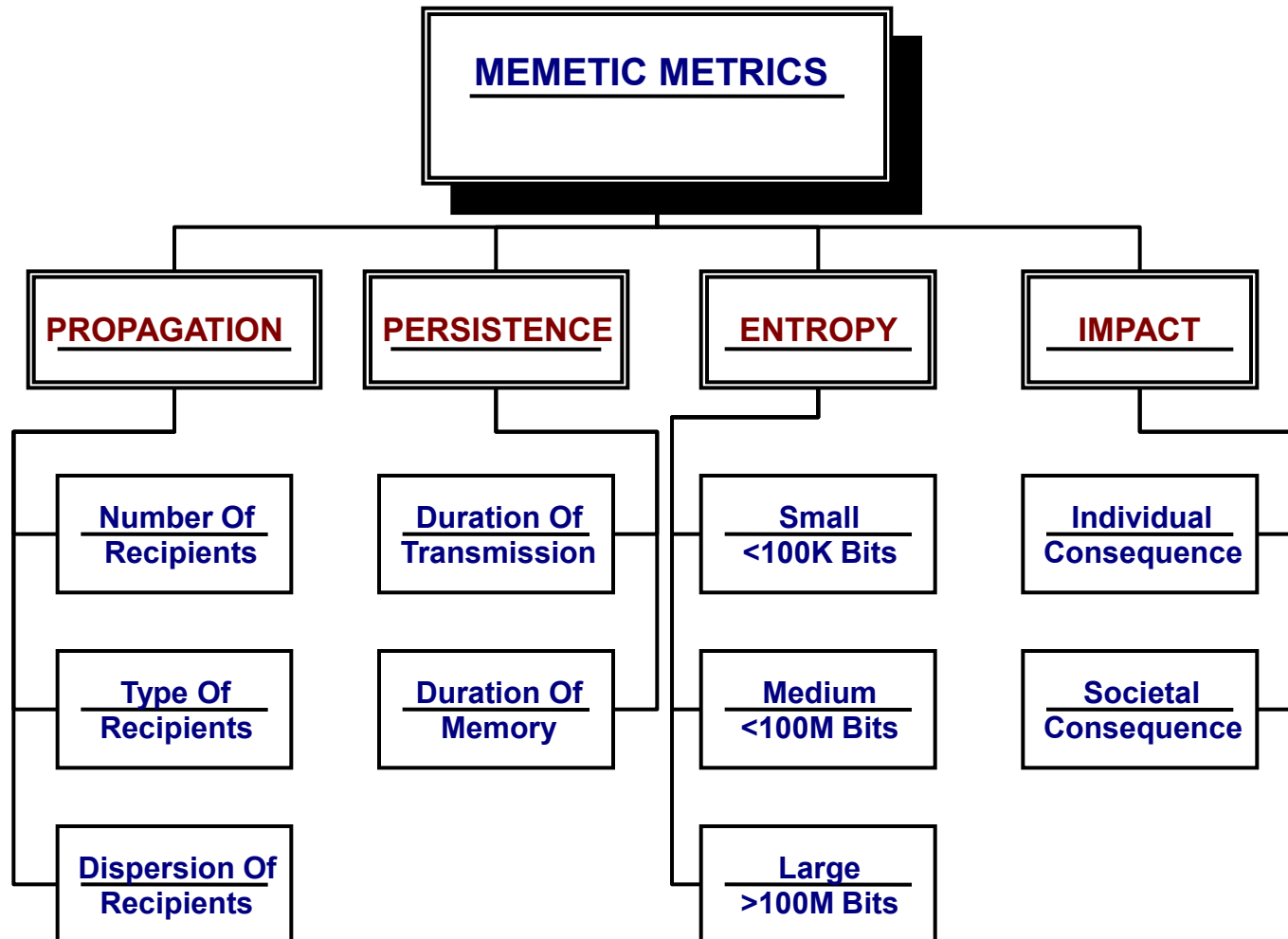

# CHARACTERIZATION OF MEME PROPAGATION AND PERSISTENCE (MINIMUMS)

LEVEL (Order of Magnitude)	PROPAGATION (NO. OF PEOPLE)	PERSISTENCE		EXAMPLE CHARACTERIZATION (Minimal Meme)
		No. Hours	No. Years	
0	1	1		Origin of meme
1	10	10		Neighborhood gossip, Text Message
2	100	100		Newspaper article
3	1,000	1000	0.1	Urban legend
4	10,000	10000	1	Cookbook
5	100,000	100000	10	Fundamentalist insurgency
6	1,000,000	1000000	100	Political ideology
7	10,000,000	10000000	1,000	Major religious canon
8	100,000,000	100000000	10,000	Instructions on growing wheat
9	1,000,000,000	1000000000	100,000	Human burial ritual
10	10,000,000,000	10000000000	1,000,000	Instructions on making flint cutting tool



# CHARACTERIZATION OF MEME PROPAGATION AND PERSISTENCE

- The previous characterizations of memes (e.g., neighborhood gossip, political ideology) are intended to relate a (rough) order-of-magnitude, represented by Level or scale of values from 0 to 10, to examples representing the population size of recipients and duration of these categories of memes
  - **Example: neighborhood gossip (Level 1) may propagate among 10 people and persist for 10 hours, while a fundamentalist insurgency (Level 5) may propagate among 100,000 people and persist for 100,000 hours (about 10 years)**





# ENTROPY AND INFORMATION

- **Entropy as a metric of information:** entropy is probably a better information sizing metric than the number of words (or bits) because it can be applied to any language as well as symbols, signs, and images – semiotics in general
  - The relative importance of meme size (e.g., small, medium, large) remains to be determined, but we have initially weighted it lower than the other metrics
  - At this time, we consider smaller memes to be more important than larger memes
  - Larger memes may all be memeplexes (e.g., the typical human brain cannot hold more than 10 “chunks” of information in short-term memory)

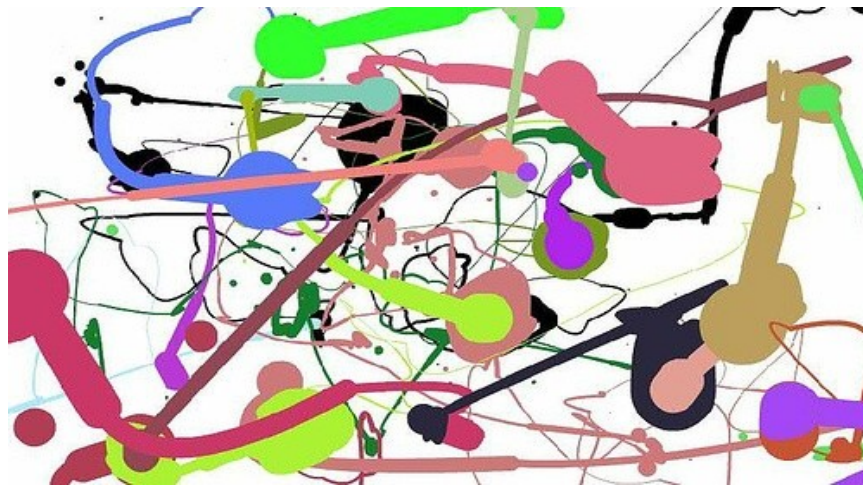

# ENTROPY AND INFORMATION

- **Entropy as a metric of information:** Claude Shannon's mathematical theory of communication measures the amount of information in any message using a function identical to that of Boltzmann's formulation of entropy
  - The use of this entropy is noncontroversial as long as it is used to measure the freedom of choice in messages and not semantic content (i.e., a specific message is selected from a larger set)

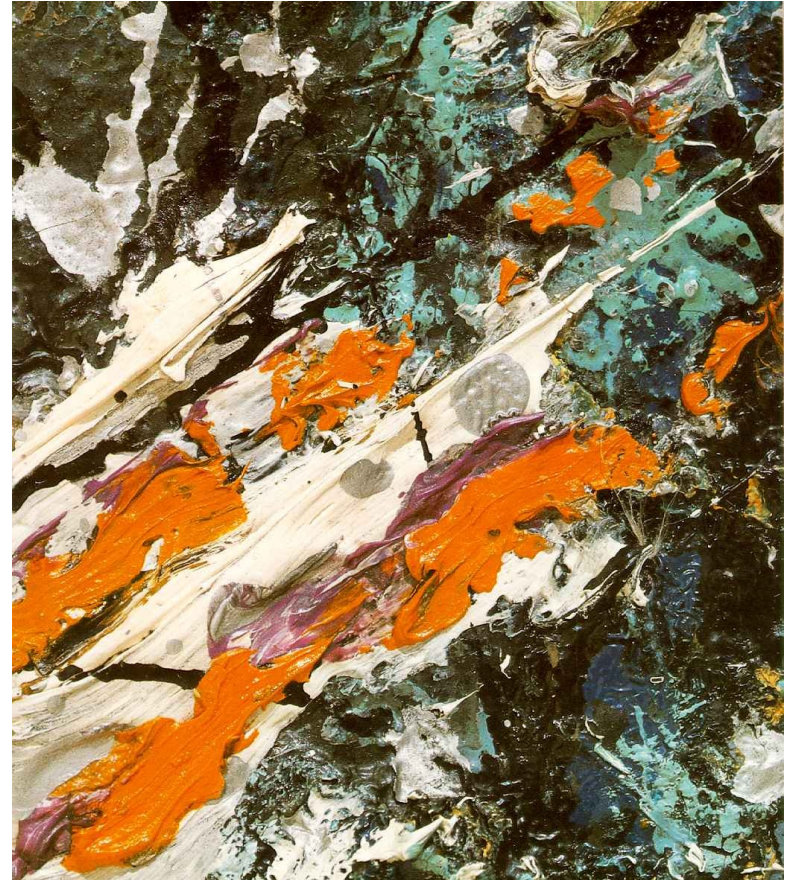

# ENTROPY AND INFORMATION

- **Example:** information (entropy) needed to select one word out of a vocabulary of 200 words is 7.6 bits ( $S = \log_2 200 = 7.6$  bits)
  - That is, the word is within the first 100 words or the second 100 words
  - It takes one bit to determine that, or one guess to as to which of the two sets it was in - if the word is in the first 100 words, it takes another bit (guess) to determine which of the two sets of 50 words it is in; and so on
  - It takes between 7 and 8 bits (guesses) to find the one word in 200 words
  - Likewise, a 50-word meme requires 380 bits (for a 200-word vocabulary). Nothing is indicated about the meaning or significance of the message that results from selecting and stringing together the 50 words

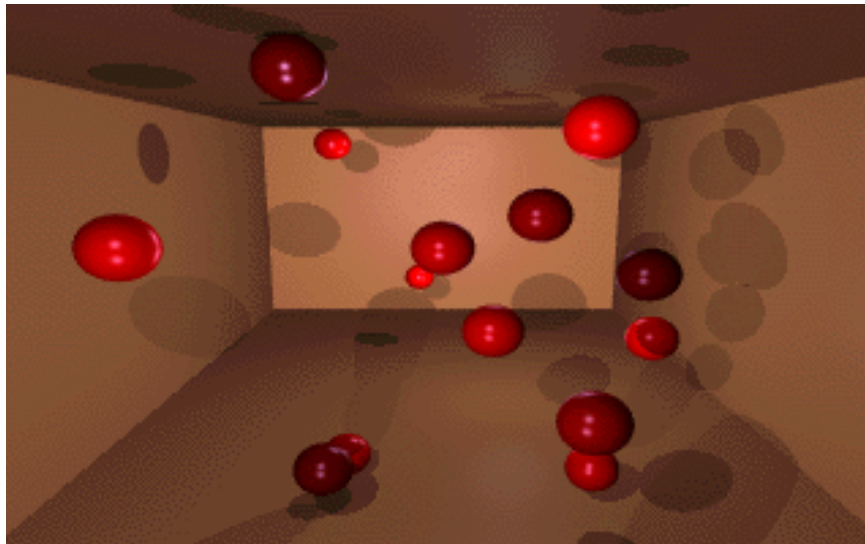



# ENTROPY AND INFORMATION

- Because of its logarithmic nature, the quantity of information (entropy) needed to isolate one item remains very modest as the total set of items increases enormously
  - If, for example, the sample space is a 20,000-word vocabulary, a 50-word meme requires only 714 bits

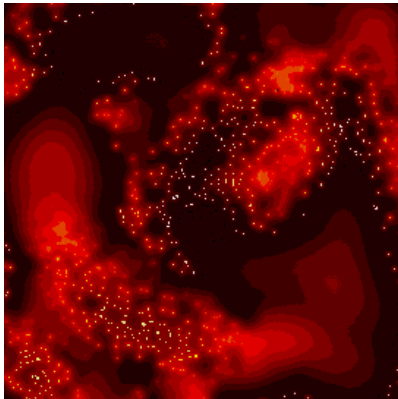
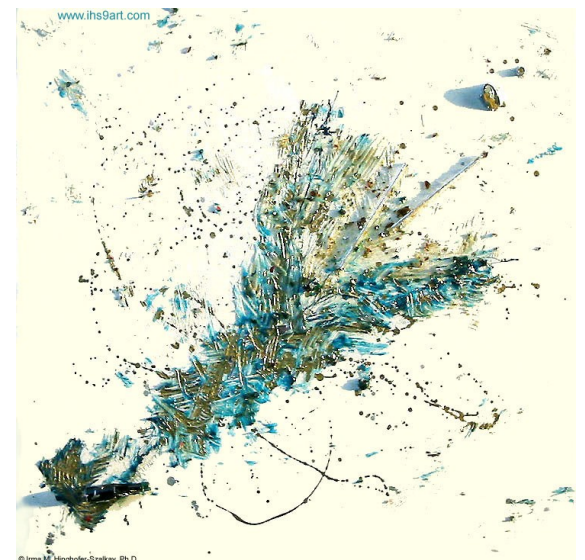
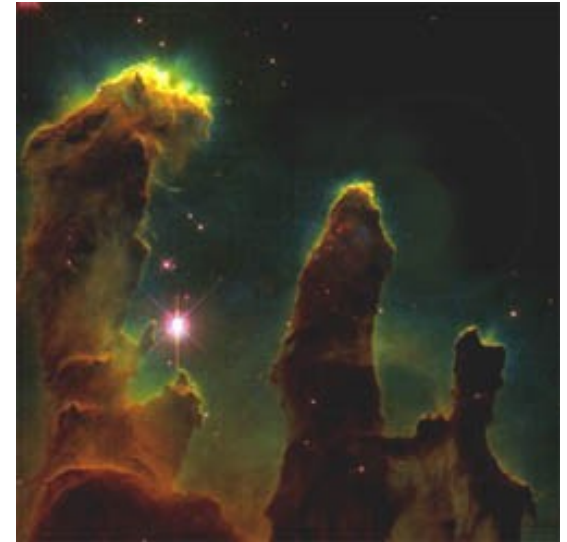

# ENTROPY AND INFORMATION

- A problem arises when entropy is used as a measure of informational order and disorder
  - For example, a manager has a desk with mounds of paper covering it - is this a high or low entropy case?
  - The manager's associate cannot find a paper he is searching for until he has made a large number of guesses, separating the piles of papers – a very high entropy case
  - But the manager knows exactly where every paper is located – the mounds of paper are quite organized in her mind; it would take her no guesses to find the crucial paper – a very low entropy case
  - Both cases concern the same set of items, but two different observers
  - Entropy then becomes a subjective measure of information (or a measure of the information contained in the brain of the observer), and this can be a disturbing concept to some

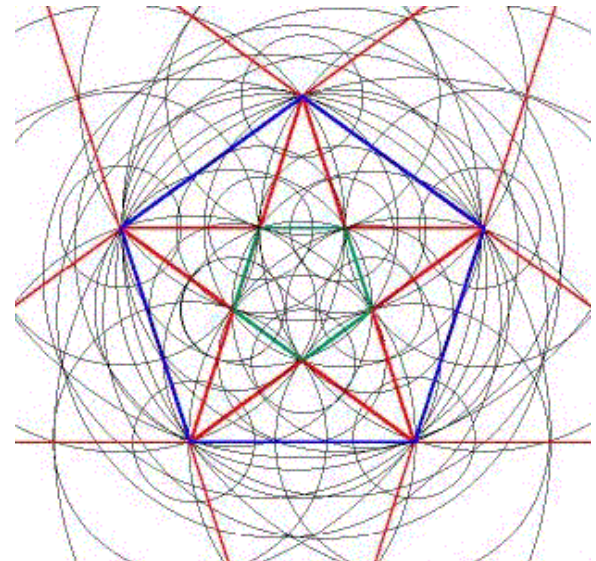
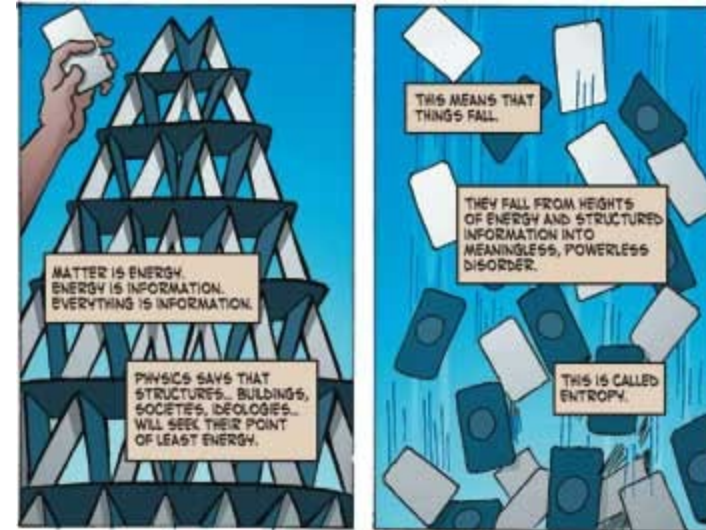

# ENTROPY AND INFORMATION

- The entropy of a meme, whether long or short, can be estimated and calculated from the individual letters or symbols
  - Based on the total number in the originating set, or from the individual words, based on the vocabulary in the originating set
  - Example: the Oxford English Dictionary contains 616,500 words and spelling bee contestants study perhaps 614,000 of those words; but, in reality, the average vocabulary of an American English speaker is estimated by various linguists as between 10,000 and 20,000 words, or optimistically between 50,000 and 70,000 words)
  - The average American would actively use only a fraction of that vocabulary





# ENTROPY AND INFORMATION

- Typically, there are about 800 words per page with 12-point Times Roman font, although publications vary considerably in the number of words, based on page size, format, and number of pages
- Shannon calculated the entropy per letter of an 8-letter chunk of English as 2.3 bits per letter, using a 26-character set (although a 76-symbol, including 26 letters, set might be generally more appropriate)
- Assuming a vocabulary of 30,000 words the entropy of a single word is about 15 bits ( $S = \log_2 30,000 = 15$  bits)
- The following Table shows the entropy as a function of the number of (English) words in memes
  - Most memes of military worth are 10 – 100,000 words, or an entropy of 150 – 1,500,000 bits

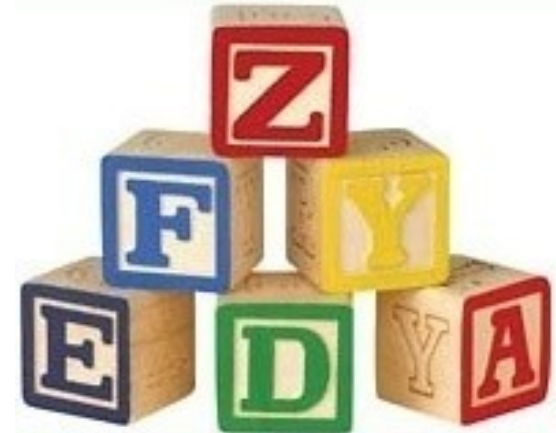
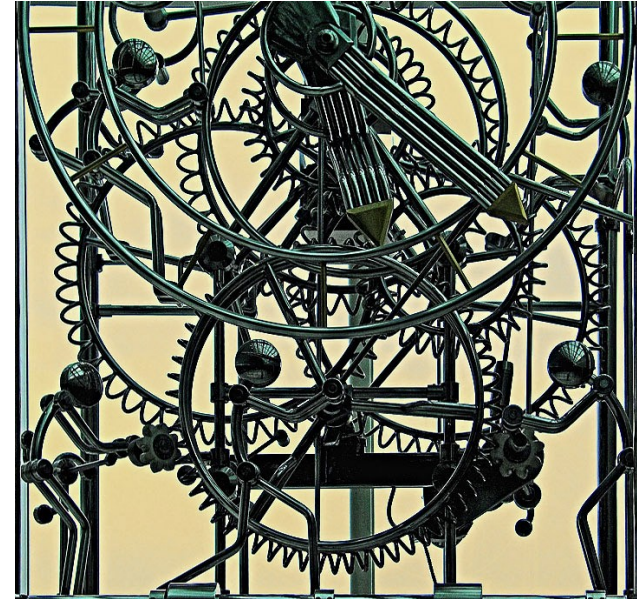

# ENTROPY AS A FUNCTION OF MEME SIZE

MEME SIZE (Words)	MEME SIZE (No. of Pages)	ENTROPY (Bits)	EXAMPLE CHARACTERIZATIONS (Approximate)
1	0.001	15	Exclamation (Hooah! Oorah! Allah!)
10	0.01	150	Catchphrase, Slogan, Exhortation (Remember the Maine! Death to America! Jesus loves you! When it absolutely, positively has to get there overnight! You'll wonder where the yellow went when you brush your teeth with Pepsodent!)
100	0.1	1,500	Sound-bite, Prayer, Incitement, Joke
1,000	1	15,000	Flyer, Poster, Advertisement, Notice, Propaganda
10,000	10	150,000	Political speech, Sermon, Polemic, Article, Blog
100,000	100	1,500,000	Field manual, Ideological indoctrination, Manifesto
1,000,000	1,000	15,000,000	Bible, Koran, Abridged dictionary
10,000,000	10,000	150,000,000	Unabridged dictionary, Religious canon
100,000,000	100,000	1,500,000,000	Federal Register, Encyclopedia Britannica, Wikipedia
1,000,000,000	1,000,000	15,000,000,000	Instructions for building nuclear submarine or Apollo spacecraft

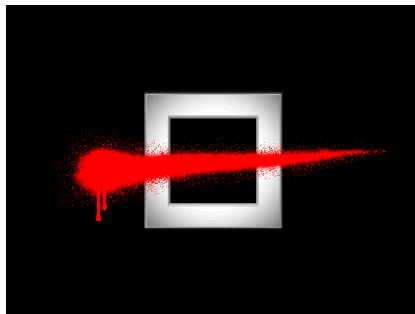

# MEMETIC METRICS AND SUBMETRICS

- **A Threshold Metric is Propagation**
  - **The submetrics for Propagation are**
    - **Number of Recipients**
    - **Type of Recipients and**
    - **Dispersion of Recipients**
  - **Depending on the problem under consideration, the type of recipients might be characterized or categorized by their economic, social, or educational class, ethnicity or culture, religion, gender, age, tribe, politics, etc.**
  - **Depending on the problem under consideration, the dispersion of recipients might be categorized as local, tribal, familial, regional, national, global, etc.**

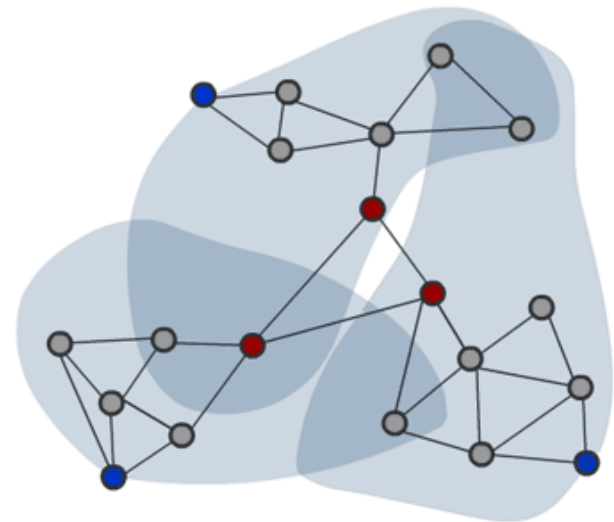
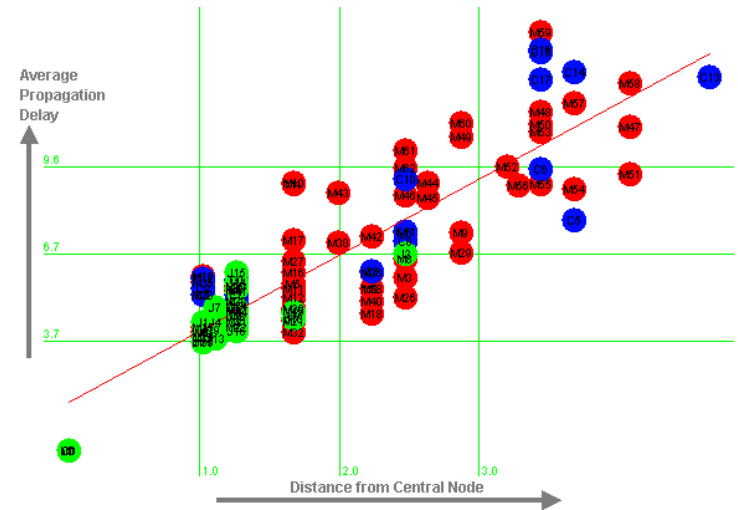



# MEMETIC METRICS AND SUBMETRICS

- **Another Threshold Metric is Persistence**
  - The submetrics for Persistence distinguish between the Duration of Transmission of the meme and Duration in Memory or storage
- **Submetrics for metric Entropy (or size)**
  - Distinguish among Small, Medium, and Large, which are (using an order of magnitude rule) characterized as less than or equal to 100K bits, less than or equal to 100M bits, & greater than 100 M bits, respectively
- **Submetrics for metric Impact**
  - Distinguish between the impact (or potential impact) of the meme on the individual (individual consequence) and its impact (or potential impact) on society as a whole (societal consequence)

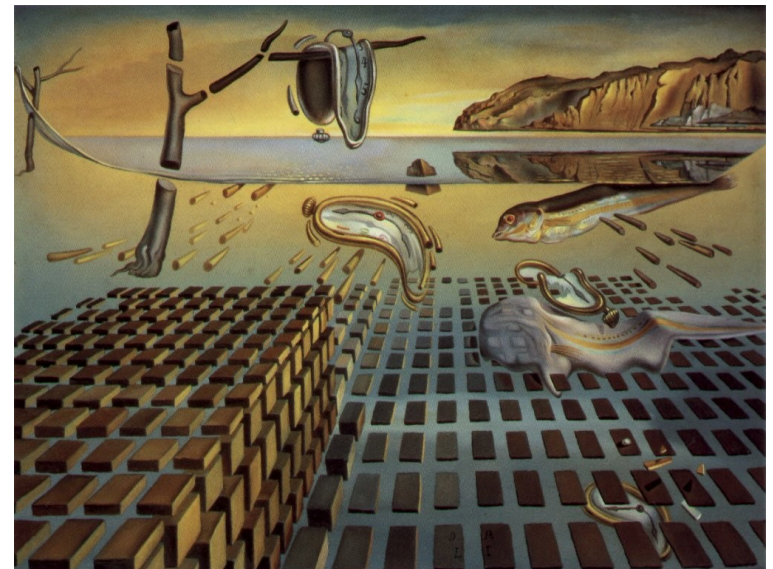

# MEMETIC METRICS AND SUBMETRICS

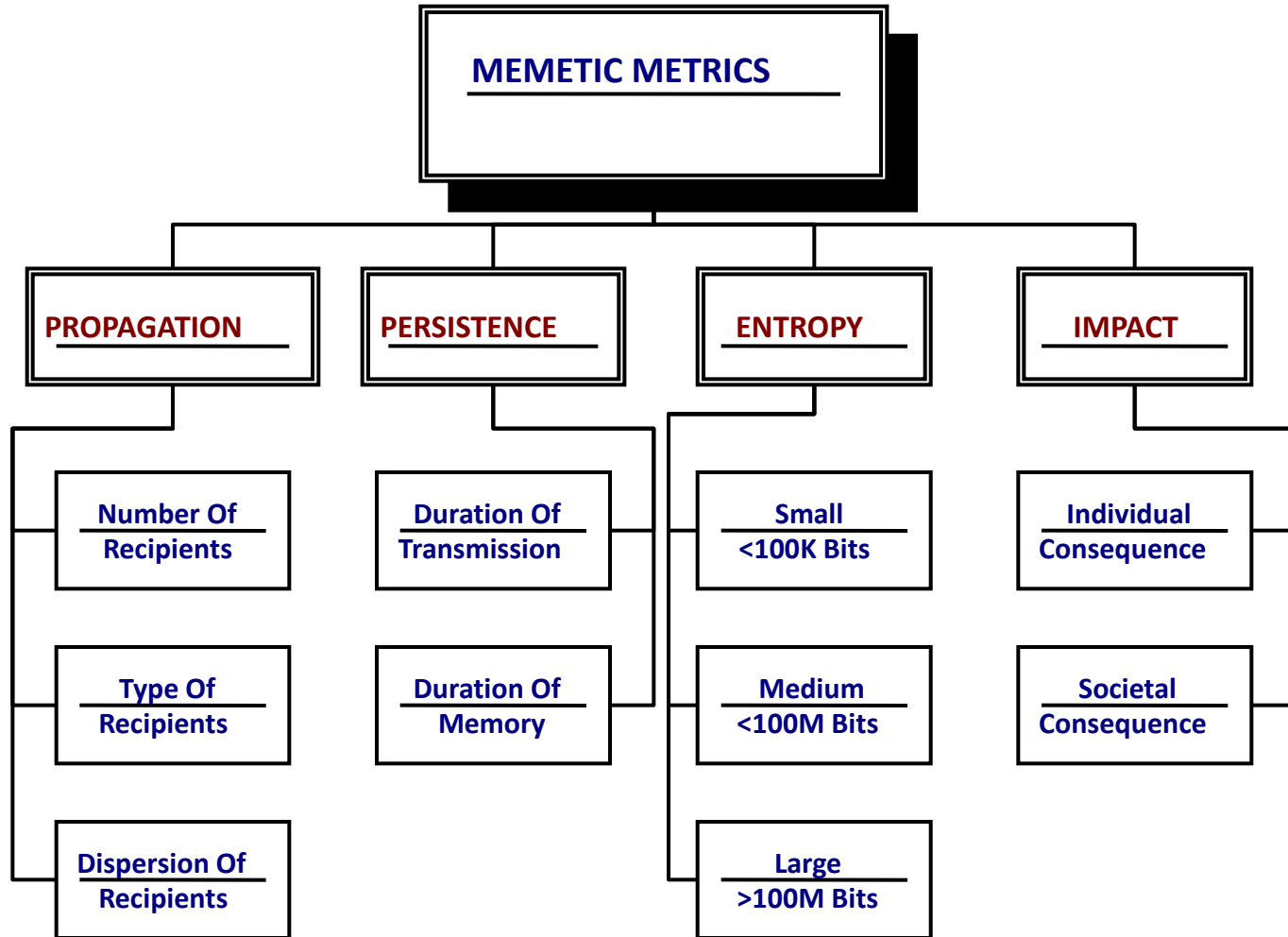

# MEMETIC METRICS AND SUBMETRICS

- **Memetic metrics were weighted using the Analytic Hierarchy Process (AHP)**
  - **This is an initial effort and not etched in stone – it should be revised as necessary, including because of experimental evidence**
  - **The AHP is used to determine the relative importance (weights or priorities) of the metrics, and can be used to evaluate (score or prioritize) alternative memes and then rank-order them**
  - **The AHP simplifies decision processes through problem structuring, decomposition and pairwise comparisons and can accommodate both quantitative and subjective inputs, merge them into single overall measure for ranking alternative choices (the underlying mathematics mostly involves solving for matrix Eigenvalues)**
  - **After defining metrics and submetrics, pairwise comparisons and a numerical scoring system are used to weight the metrics and submetrics, then evaluate and rank alternative memes against the weighted metrics and submetrics**

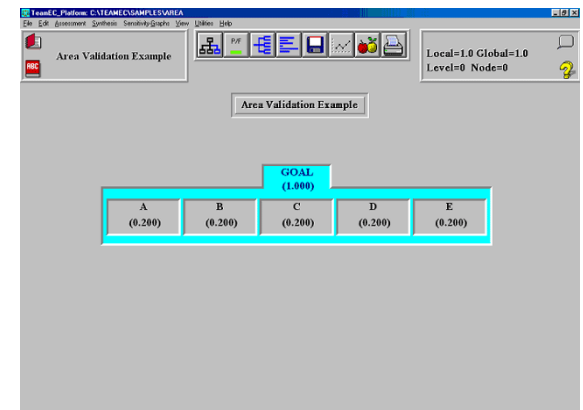
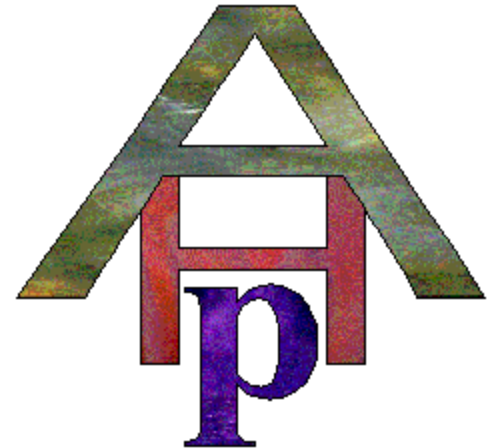



# MEMETIC METRICS AND SUBMETRICS

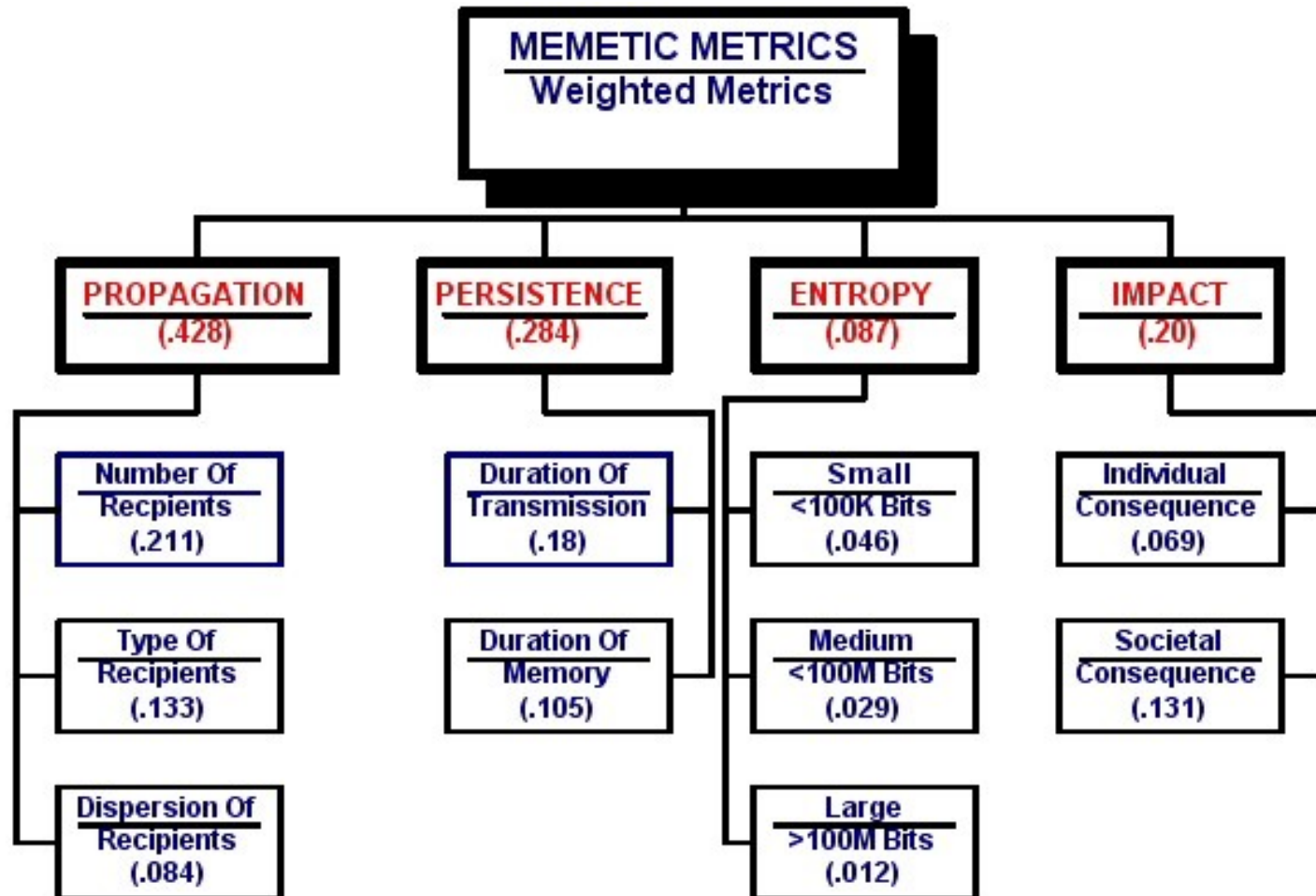

# WEIGHTED METRICS AND SUBMETRICS

- The **Propagation** metric is deemed more important (weighted more) than **Persistence** (and the other metrics) because it is more easily measured or estimated and more relevant concerning memes of military worth, especially in the near-term
- The **Impact** metric is deemed somewhat less important than **Persistence** because it is more difficult to measure, especially in the real-world, in the near-term (in a model, with a God's-eye view, **Impact** might be considered the most important metric)
- The **Entropy** metric is deemed least important because the size of the meme, while influential, is not critical in its ability to propagate, persist, and impact (alter behavior), especially for digital media (e.g., images and videos)



# WEIGHTED METRICS AND SUBMETRICS

- For the **Propagation** submetrics, the **Number of Recipients** is more heavily weighted than the **Type or Dispersion of Recipients** submetrics because it is more easily measured than the other submetrics and it alone can serve as a useful crude indicator of successful propagation
  - The **Type and Dispersion of Recipients** are demographic details which refine the efficacy of the meme's dispersion but are not as important as the sheer **Number of Recipients**

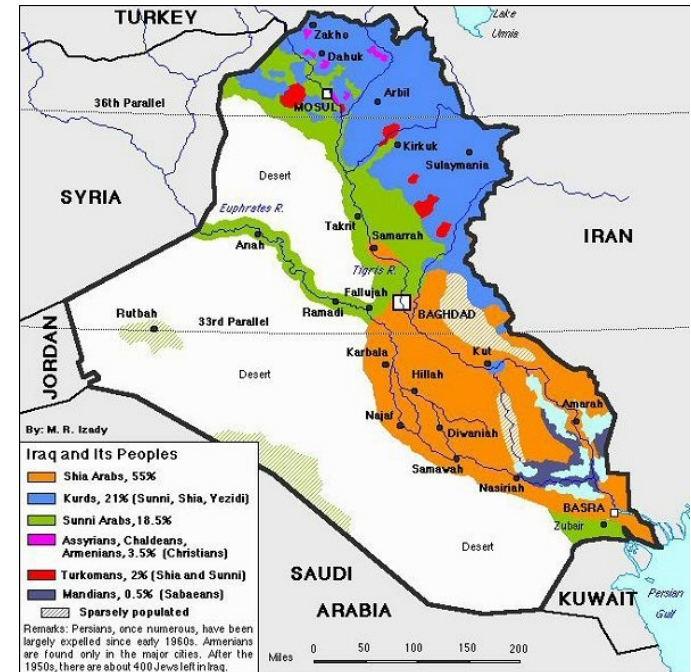



# WEIGHTED METRICS AND SUBMETRICS

- For the **Persistence** submetrics, the **Duration of the Transmission** of the meme is deemed somewhat more important than **Duration of the Memory** (in mind or artifact) of the meme because
  - It is easier to measure and more important for meme's of immediate military worth



# WEIGHTED METRICS AND SUBMETRICS

- For the **Entropy** submetrics, the **Small** categorization is deemed more important than **Medium**, which is deemed more important than **Large**
  - Despite meme size being less important with digital media, the human brain is still size and retention limited and is generally more responsive to briefer memes
- For **Impact** submetrics, the **Societal Consequences** of memes are deemed more important than the **Individual Consequences** (e.g., the altered behavior of many is generally of greater consequence than that of a single person, even if a single person may sometimes alter history)

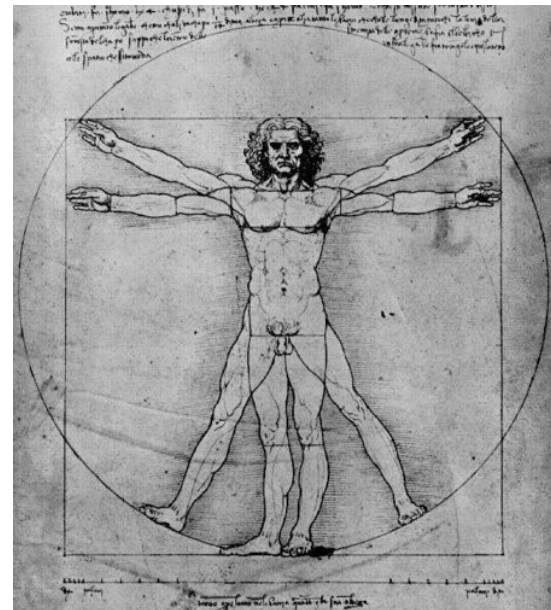

# A MEMETICS FITNESS FACTOR

- We made an initial attempt to create a method (equation) for deriving numbers to characterize memes so they can be conveniently evaluated against one another
  - The equation includes the previously defined metrics
  - The equation is an initial hack at the problem and is intended to elicit comments and suggestions for improvement
  - Experimental results are likely to alter the notion (and equation) of memetic fitness

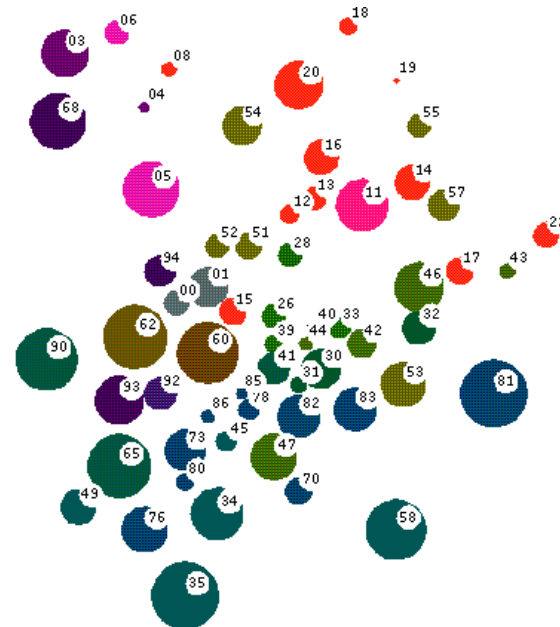
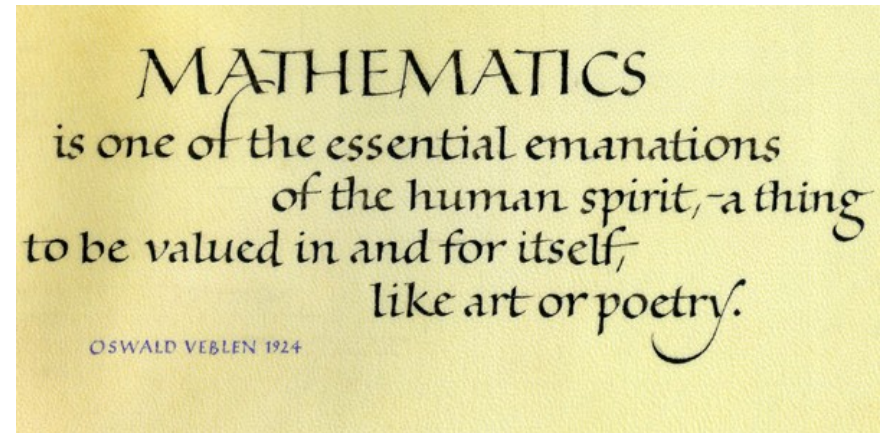



# A MEMETICS FITNESS FACTOR

- **$M = P_r P_e I / S$** 
  - Where:  $P_r$  = Propagation (number of people [transformation])
  - $P_e$  = Persistence (time [transformation])
  - $I$  = Impact (dimensionless number)
  - $S$  = Entropy (number of bits [transformation])
  - $M$  = Memetic Fitness (person-hours/bit)
- **Memetic Fitness is given in (transformed) units of person-hours/bit**
  - This seems appropriate in that it characterizes a level of effort expended, in various ways, per unit of information in the meme
  - With a different derivation, Memetic Fitness might be defined as a dimensionless number



# MEMETICS FITNESS FACTOR VARIABLES: PROPAGATION

$$P_r = \sum_{i=1}^3 W_i R_i$$

- Where:  $P_r$  = Propagation
- $R_1 = \text{Log}_{10}N$  (where  $N$  = number of recipients) ( $0 \geq R_1 \leq 10$ )
- $R_2$  = Characterization of types of recipients ( $0 \geq R_2 \leq 10$ )
- $R_3$  = Characterization of dispersion of recipients ( $0 \geq R_3 \leq 10$ )
- $W_1, W_2, W_3$  = Weighting factors for  $R_1, R_2, R_3$ , respectively



# MEMETICS FITNESS FACTOR VARIABLES: PERSISTENCE

$$P_e = \sum_{i=1}^2 W_i D_i$$

- Where:  $P_e$  = Persistence
- $D_1$  = Characterization of duration of transmission ( $0 \geq D_1 \leq 10$ )
- $D_2$  = Characterization of duration of memory ( $0 \geq D_2 \leq 10$ )
- $W_1, W_2$  = Weighting factors for  $D_1, D_2$ , respectively





# MEMETICS FITNESS FACTOR VARIABLES: IMPACT

$$I = \sum_{i=1}^2 W_i C_i$$

- **Where: I = Impact**
- **$C_1$  = Characterization of consequence of the meme on individual ( $0 \leq C_1 \leq 10$ )**
- **$C_2$  = Characterization of consequence of the meme on society ( $0 \leq C_2 \leq 10$ )**
- **$W_1, W_2$  = Weighting factors for  $C_1, C_2$ , respectively**





# MEMETICS FITNESS FACTOR VARIABLES: ENTROPY

$$S = W \log_{10} S_m$$

- **Where: S = Fitness entropy characterization**
- **$S_m$  = Entropy of meme (bits);  $S_m = \log_2 n$  (where  $n$  = vocabulary size)**
- **W = Weighting factor**



# MEMETICS FITNESS FACTOR

➤  $M = P_r P_e I/S$

- In this definition,  $M$  is directly proportional to Propagation, Persistence, and Impact, and inversely proportional to entropy
- A conjecture is that smaller memes (lower entropy) lead to a higher fitness factor than larger memes
- Units are person-hours/bit
- The hypothesis is that the greater the “effort”/bit in the meme, the more important the meme



# MEME REPLICATION & PROPAGATION

- **Successful replication and propagation of meme independent of usual social criteria of “good” or “bad” (e.g., truth, ethics, or science)**
  - **Good ideas can become extinct while bad ideas flourish**
- **A successful insurgency requires the active support of few and the acquiescence of many**





# MEME REPLICATION & PROPAGATION

Mememes (like genes) do not have cognition or foresight – they (like genes) have **algorithms** which drive **natural selection**

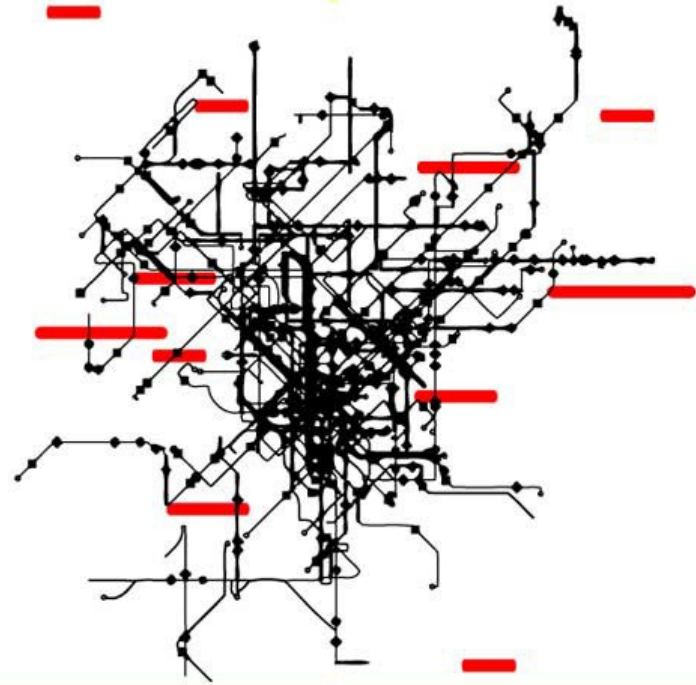
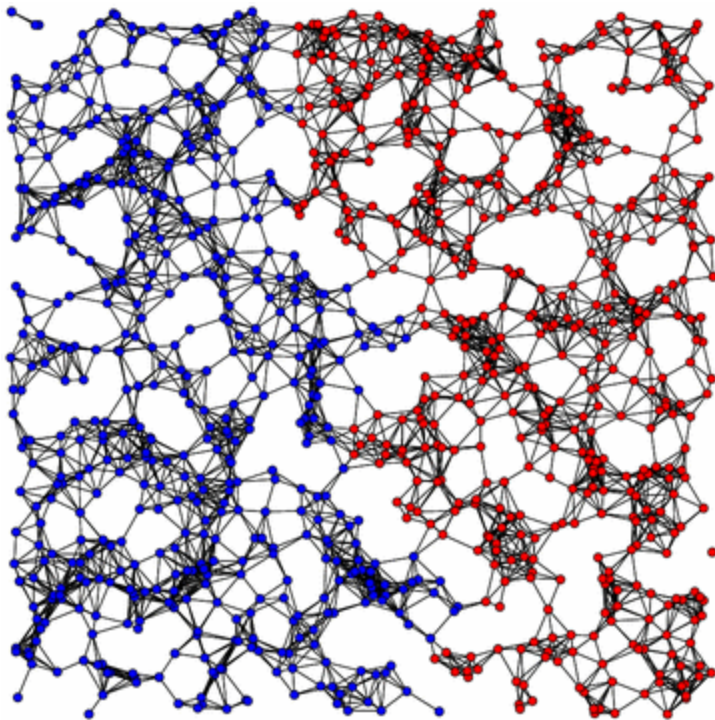





# MEMES: EVOLUTIONARY ALGORITHM

**Replicators:** The evolutionary algorithm (heredity, variation, selection) can run on different substrates (genes and memes)

- **Humans are the product of two replicators: genes and memes**
- **Memes might explain**
  - Why humans constantly think and talk
  - “Excessively” large human brains
  - Non-genetic altruism & **suicide bombers**
  - Any behavior adverse to genetic survival

## ➤ **Example Memes**

- Ideas, tunes, poems, catch-phrases, fashion, technological processes (e.g., making arrowheads or gumbo), fables, religion, graffiti, images, novels, movies, **insurgent or terrorist culture**, military culture (training, tactics, strategy, doctrine, policy)

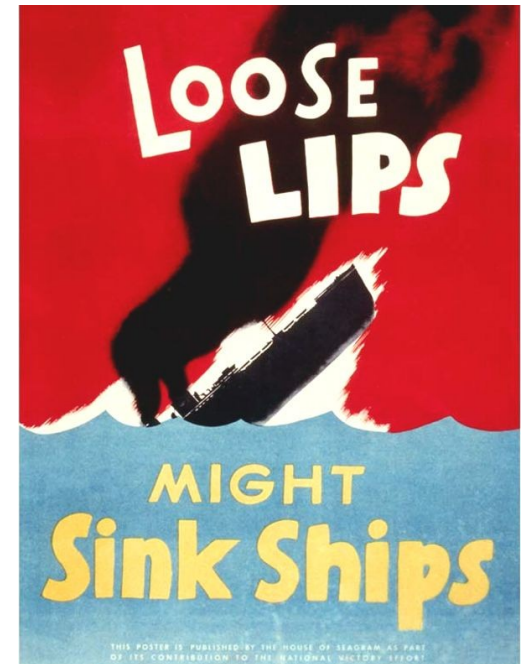

# MEME LIFECYCLE

- **Host transmits meme intentionally or unintentionally**
- **Transmission Vector**
  - **Meme received and encoded by host**
  - **Meme transmitted to new host via stone engraving, speech, text, image, observed behavior, email**

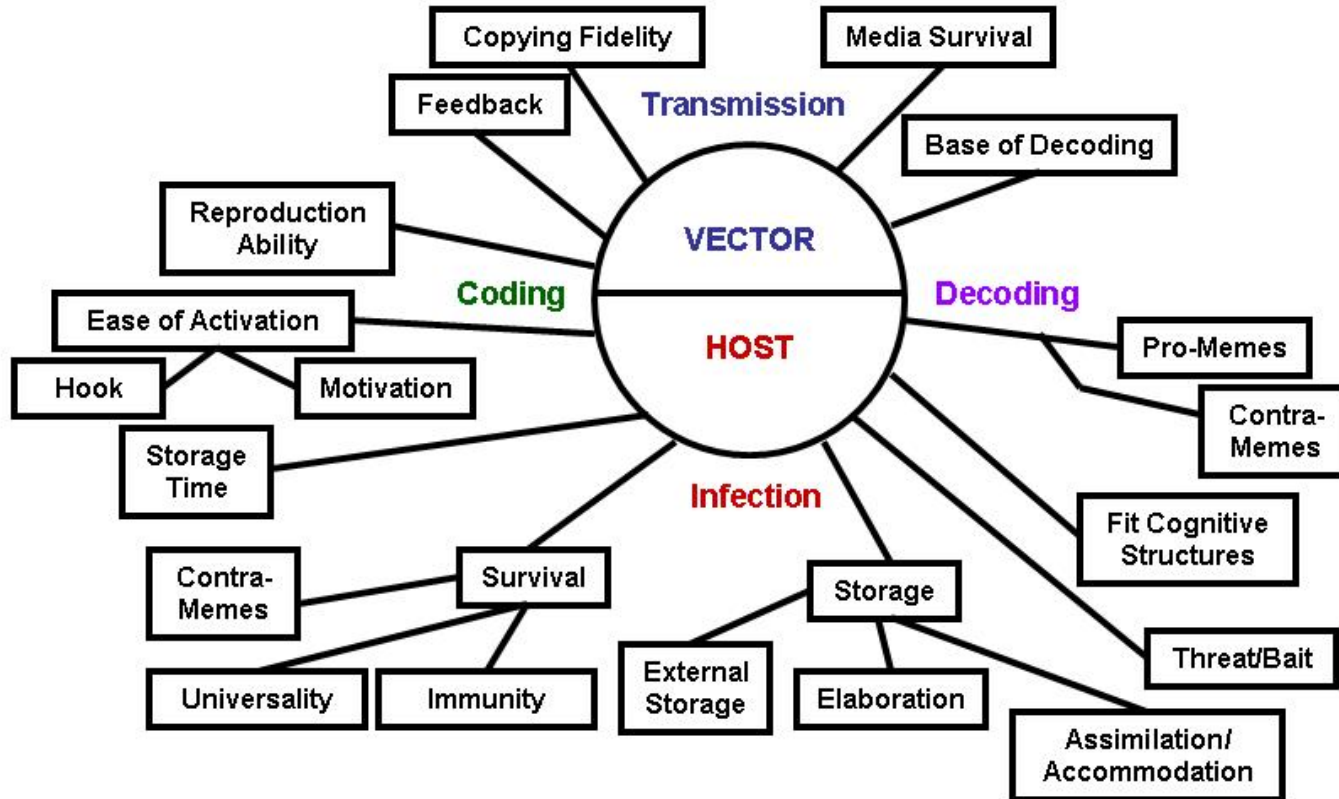



# MEME LIFECYCLE

**Meme Lifecycle resembles Claude Shannon's iconic schematic of a general communications system**

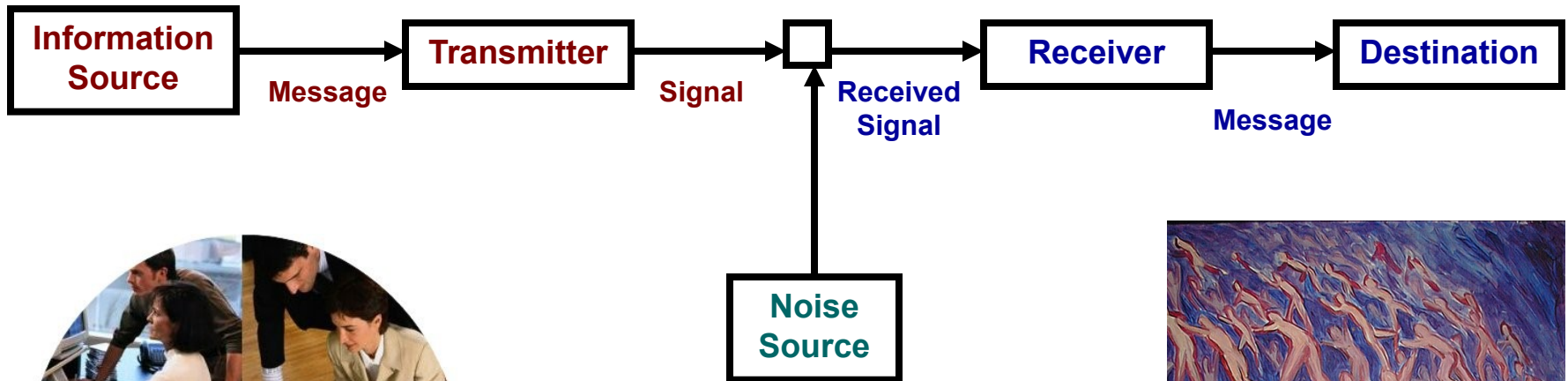

# MEME LIFECYCLE

- **New Potential Host**
  - **Meme received and decoded**
  - **Becomes host if meme satisfies selection and fitness criteria**
- **New host replicates and transmits meme (perhaps with different vector)**
- **There is a great excess of potential memes over available brains**

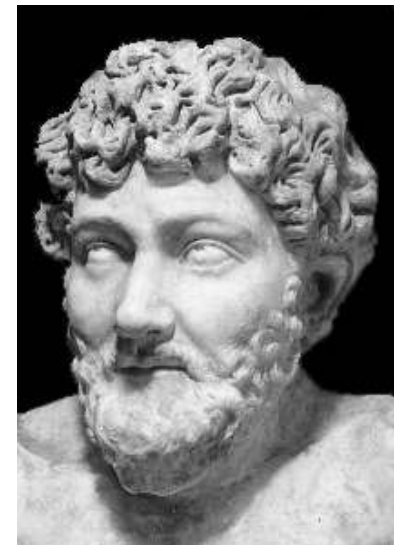
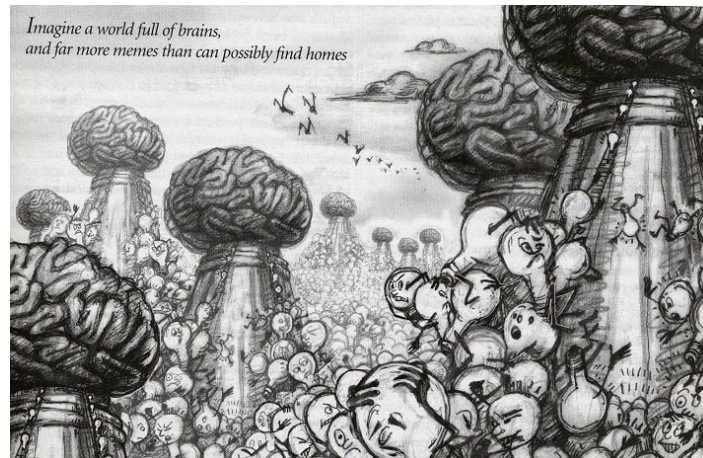
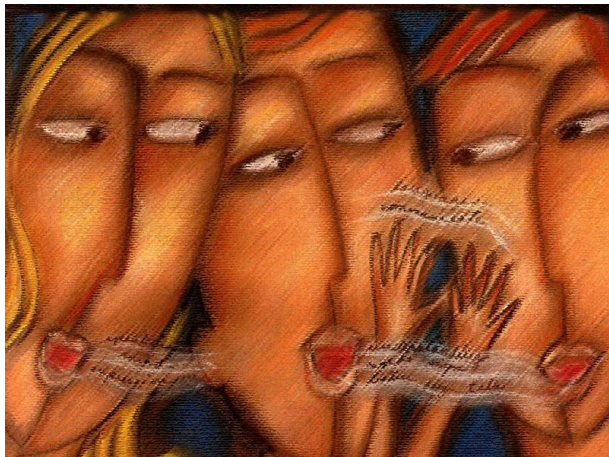
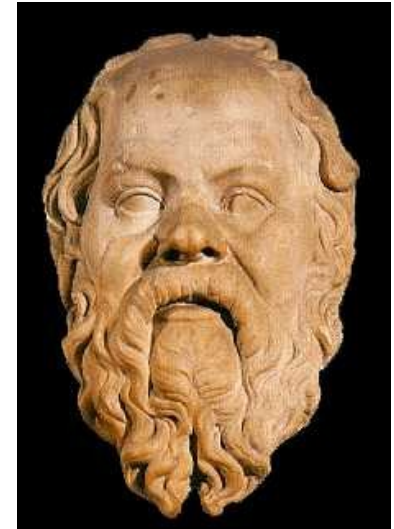



# MEME LIFECYCLE

## Selection and Fitness Criteria

- **Motivation & Hooks**
  - Threats: hell or failure
  - Rewards: heaven or success
  - Beneficial or entertaining
  - Appreciative Direct Feedback
- **Fit Existing Constructs**
  - Receptive paradigms or belief systems
  - Memes aggregate and reinforce in complexes
- **Suitable Storage**
  - Memory or media
- **Enduring Vectors**
  - E.g., chiseled in stone; certain books



# MEME LIFECYCLE

- **Mememes can be transmitted without true communication**
  - **The sender can pass mememes to the receiver using deception where the intent of the sender is not communicated to the receiver**
  - **Or mememes might be diffused through a population without overt imitation by receivers**
- **Memetic mutations can be directed by purposeful human decision-making as well as by random processes**
  - **Lamarckian as well as Darwinian evolution**
  - **With directed (Lamarckian) processes, memetics becomes analogous to genetic engineering**





# POTENTIAL MILITARY WORTH OF MEMETICS

- Information Operations
- Military culture
  - Recruitment
  - Training
  - Deterrence
  - Tactics, Strategy, Doctrine
  - Peacekeeping and occupation
  - Nation building
- Adversarial culture
  - Military, insurgents, terrorists, civilians
- Reduce probability of war or defeat
- Increase probability of peace or victory



# POTENTIAL MILITARY WORTH OF MEMETICS

## ➤ Information Operations (IO)

➤ The integrated employment of the core capabilities of:

- Electronic warfare
- Computer network operations
- Psychological operations
- Military deception and operations security

➤ In concert with specified supporting and related capabilities, to influence, disrupt, corrupt or usurp adversarial human and automated decision making while protecting our own

- According to Joint Publication 3-13 *Information Operations* (13 February 2006)

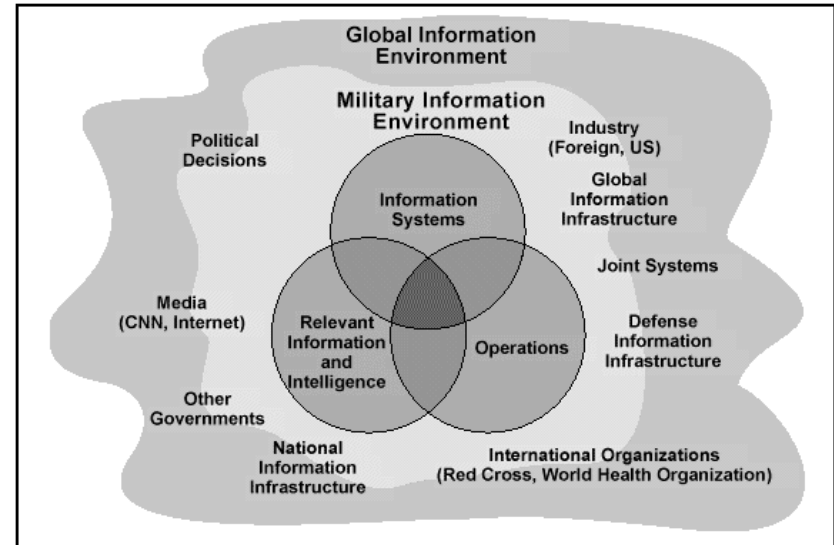

# POTENTIAL MILITARY WORTH OF MEMETICS

- **Psychological Operations (PSYOP)**
  - **Purpose: to induce or reinforce foreign attitudes and behavior favorable to the originator's objectives**
  - **To convey selected information and indicators to foreign audiences to influence their emotions, motives, objective reasoning, and ultimately the behavior of foreign governments, organizations, groups, and individuals**
  - **Focuses on cognitive domain of the battlespace and targets the mind of the adversary**
  - **Seeks to induce, influence, or reinforce the perceptions, attitudes, reasoning, and behavior of foreign leaders, groups, and organizations in a manner favorable to friendly national and military objectives**
  - **Exploits the psychological vulnerabilities of hostile forces to create fear, confusion, and paralysis, thus undermining their morale and fighting spirit**





# POTENTIAL MILITARY WORTH OF MEMETICS

## CATEGORIES OF MILITARY PSYCHOLOGICAL OPERATIONS

### Strategic Psychological Operations (PSYOP)

International information activities conducted by US Government agencies to influence foreign attitudes, perceptions, and behavior in favor of US goals and objectives during peacetime and in times of conflict. These programs are conducted predominantly outside the military arena but can utilize Department of Defense assets. Military PSYOP with potential strategic impact must be coordinated with national efforts.

### Operational PSYOP

Conducted across the range of military operations, including during peacetime, in a defined operational area to promote the effectiveness of the joint force commander's campaigns and strategies.

### Tactical PSYOP

Conducted in the area assigned a tactical commander across the range of military operations to support the tactical mission against opposing forces.

Joint Publication 3-53



## Doctrine for Joint Psychological Operations



5 September 2003



# POTENTIAL MILITARY WORTH OF MEMETICS

## Psychological Operations

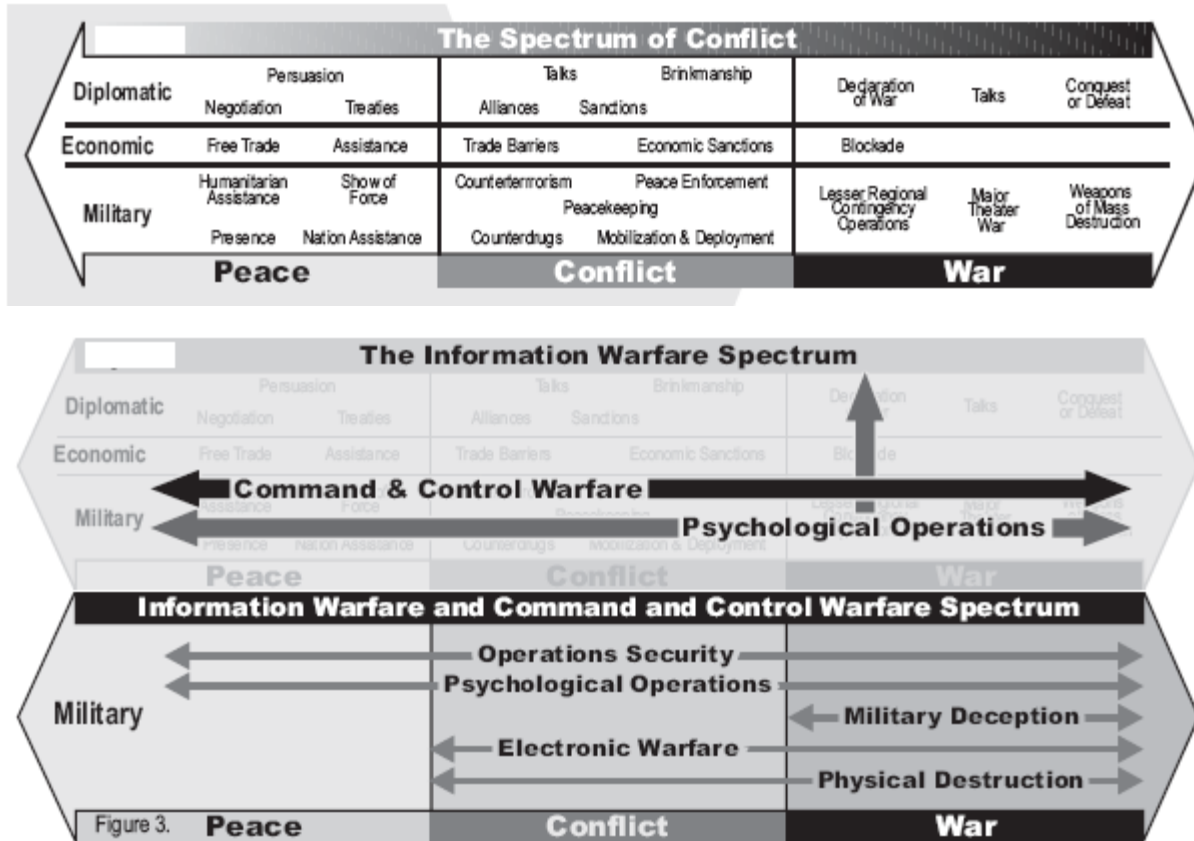

From "Information Age Psychological Operations," Commander Randall G. Bowdish, US Navy, *Military Review*, Dec 98 – Feb 99

# POTENTIAL MILITARY WORTH OF MEMETICS

- **Psychological Operations (PSYOP)**
  - **According to *Information Operations Roadmap*, DOD, 30 Oct. 03:**
    - **PSYOP capabilities have deteriorated and remedial action is required**
    - **PSYOP is a “low-density, high-demand asset which is particularly valued in the war on terrorism”**
    - **“Well-documented PSYOP limitations include:**
      - **Inability to rapidly generate and immediately disseminate sophisticated, commercial-quality products targeted against diverse audiences**
      - **Limited ability to disseminate PSYOP products into denied areas”**

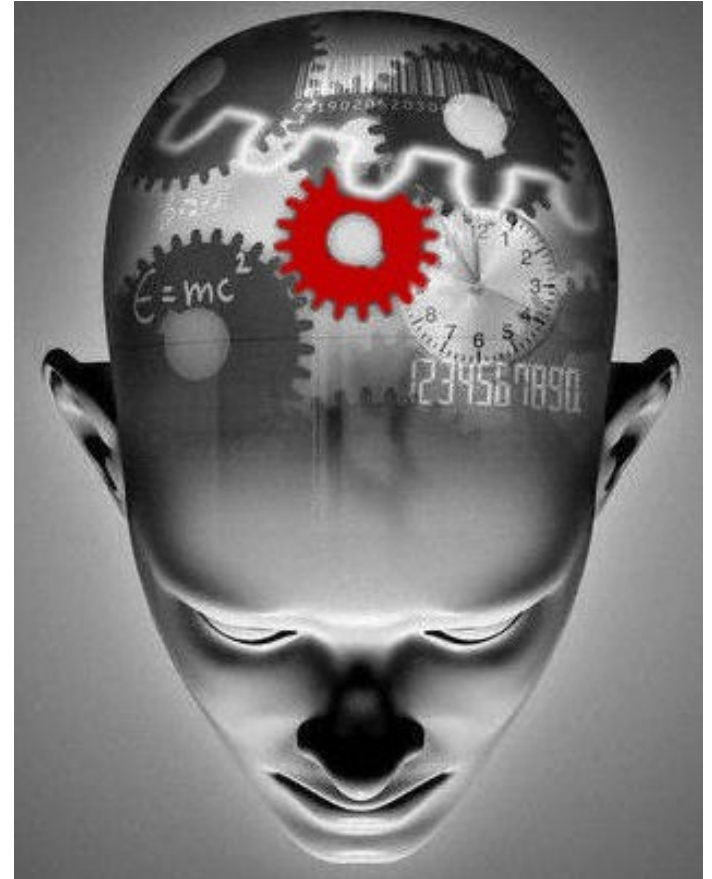



# POTENTIAL MILITARY WORTH OF MEMETICS

## ➤ **Military Deception (MILDEC)**

- **Actions executed to deliberately mislead adversary military decision makers as to friendly military capabilities, intentions, and operations, thereby causing the adversary to take specific actions (or inactions) that will contribute to the accomplishment of the friendly forces mission**
- **Military deception will not intentionally target or mislead the US public, Congress, or the news media**



# POTENTIAL MILITARY WORTH OF MEMETICS

## ➤ Military Deception (MILDEC)

➤ According to *Information Operations Roadmap*, DOD, 30 Oct. 03:

- “Military deception should be one of the five core capabilities of IO..”
- “The value of military deception...is intuitive”
- “Effective military deception requires centralized planning, security, and close integration with operational planning”

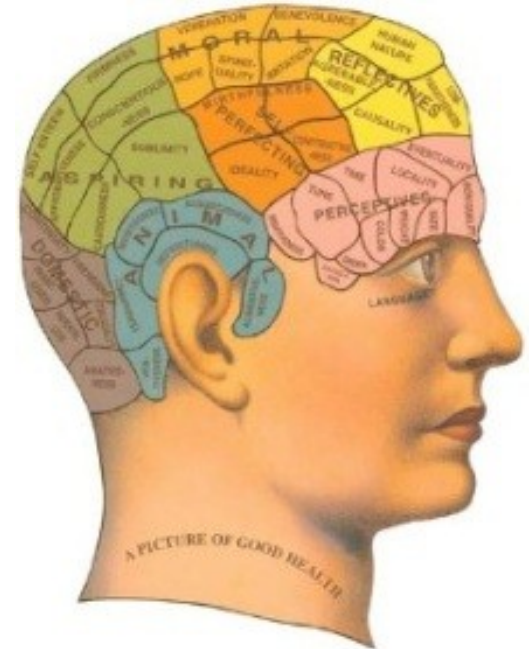

# POTENTIAL MILITARY WORTH OF MEMETICS

## ➤ Counterpropaganda

- **Activities to identify and counter adversary propaganda and expose adversary attempts to influence friendly populations and military forces situational understanding**
- **Efforts to negate, neutralize, diminish the effects of, or gain an advantage from foreign psychological operations or propaganda efforts**
- **Commanders at all levels should integrate activities designed to:**
  - Disseminate truthful information
  - Mitigate adversary messages
  - Disrupt, degrade, and disable adversary psychological operations





# POTENTIAL MILITARY WORTH OF MEMETICS

- **Public Affairs Operations (PA)**
  - **Assess the information environment in areas such as public opinion and to recognize political, social, and cultural shifts**
  - **A key component of informational flexible deterrent options**
  - **Build commanders' predictive awareness of the international public information environment and the means to use information to take offensive and preemptive defensive actions**
  - **Lead activity and the first line of defense against adversary propaganda and disinformation**
  - **Must never be used to mislead the public, national leaders, or the media**

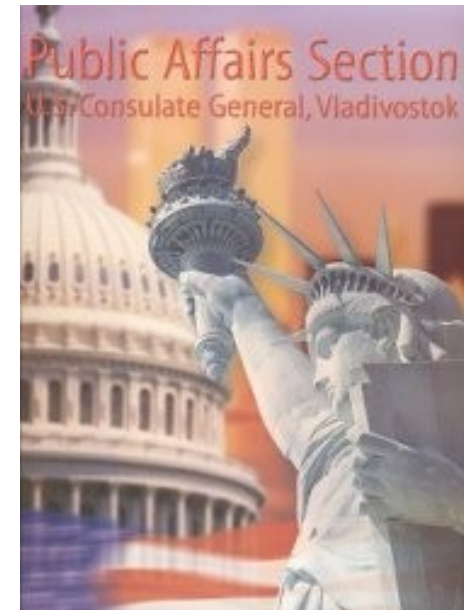

# POTENTIAL MILITARY WORTH OF MEMETICS

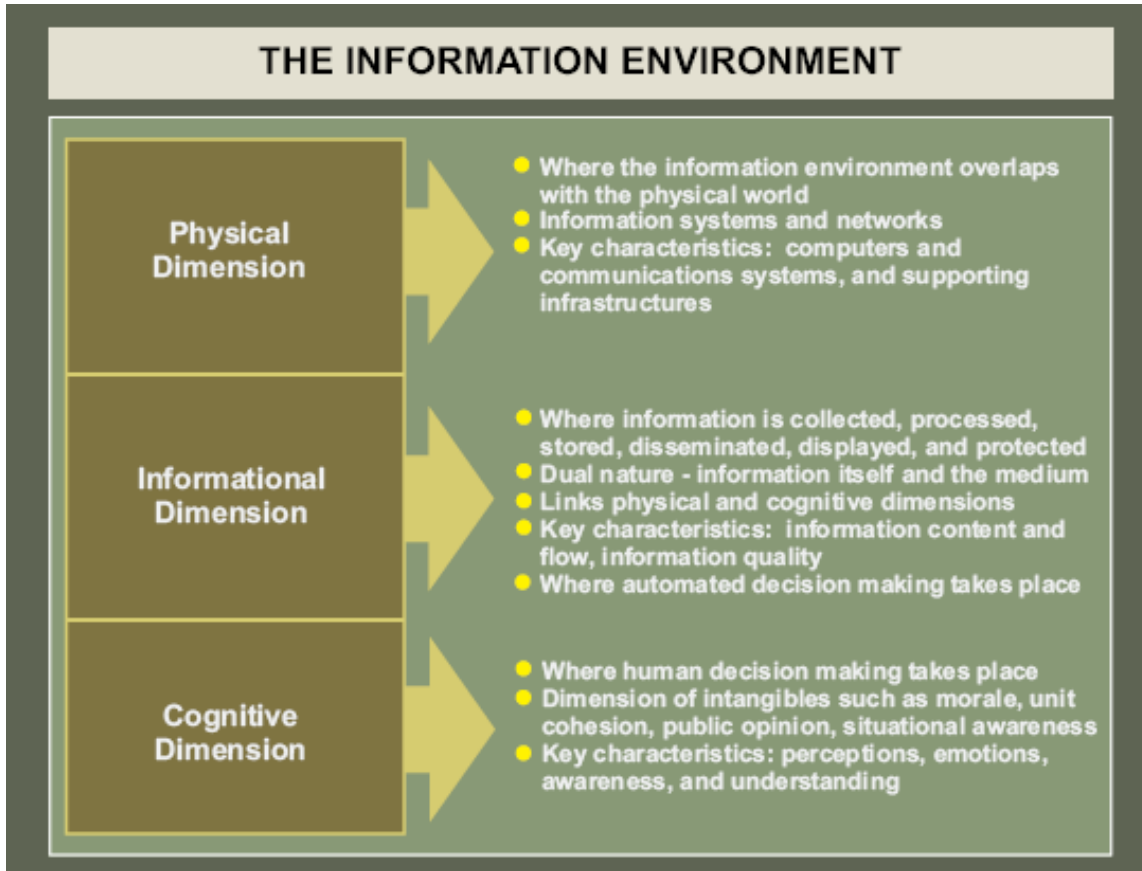

**Joint Publication 3-13**

**Information Operations**

13 February 2006

The cover of Joint Publication 3-13, Information Operations, features the Department of Defense seal at the top center, the Joint Chiefs of Staff seal in the middle, and the Department of Defense seal at the bottom center. It also includes the seals of the Department of the Army, the Department of the Navy, the Department of the Air Force, and the Department of the Marine Corps.

# POTENTIAL MILITARY WORTH OF MEMETICS

## INFORMATION QUALITY CRITERIA

### ACCURACY

Information that conveys the true situation

### RELEVANCE

Information that applies to the mission, task, or situation at hand

### TIMELINESS

Information that is available in time to make decisions

### USABILITY

Information that is in common, easily understood format and displays

### COMPLETENESS

Information that provides the decision maker with all necessary data

### BREVITY

Information that has only the level of detail required

### SECURITY

Information that has been afforded adequate protection where required





# POTENTIAL MILITARY WORTH OF MEMETICS

## ➤ Public Affairs

- According to Field Manual FM 46-1, Public Affairs Operations, HQ, Department of the Army, Washington, DC, 30 May 1997
- Public Affairs operations are combat multipliers by:
  - Keeping soldiers informed
  - Maintaining public support for the soldier in the field
  - Mitigating the impact of misinformation and propaganda



# POTENTIAL MILITARY WORTH OF MEMETICS

- **Military and adversarial culture**
  - **Recruitment**
    - Motivation
    - Enhance image of military
    - Service awareness (“branding”)
    - National service perspective
    - Global situational context
  - **Training**
    - Motivation
    - Explanation
    - Comprehension
    - Retention
    - Culture (traditions, customs, mores)



# MEMES AND SOCIAL MEDIA

- Social media (e.g., smart phones) have provided highly effective and efficient means for propagating memes (e.g., voice, texting, and tweeting)
  - For state and non-state actors
  - For strategic and tactical objectives
- Popular uprisings (e.g., the Middle East) demonstrated the efficacy of social media
- Tools and techniques are being developed to (1) rapidly detect, identify, and evaluate memes propagated by social media; (2) rapidly create and propagate counter-memes
- A framework for Meme-War is the Meme Control Center



# MEME CONTROL CENTER

- **A conceptual Meme Control Center (MCC) consists of a Meme Processing Center (MPC) and a Counter-Meme Processing Center (CPC)**
- **A Memetics for Intelligence and National Defense (MIND) Research and Development Center provides the tools and techniques employed by the MPC and CPC)**
- **The MPC is highly automated with, for example, information mining and semantic processing)**
- **The CPC includes a multi-disciplinary meme engineering staff (e.g., cultural anthropologists, linguists, semanticists, psychologists, social network analysts, O.R. analysts, intelligence and psyops analysts, economists)**

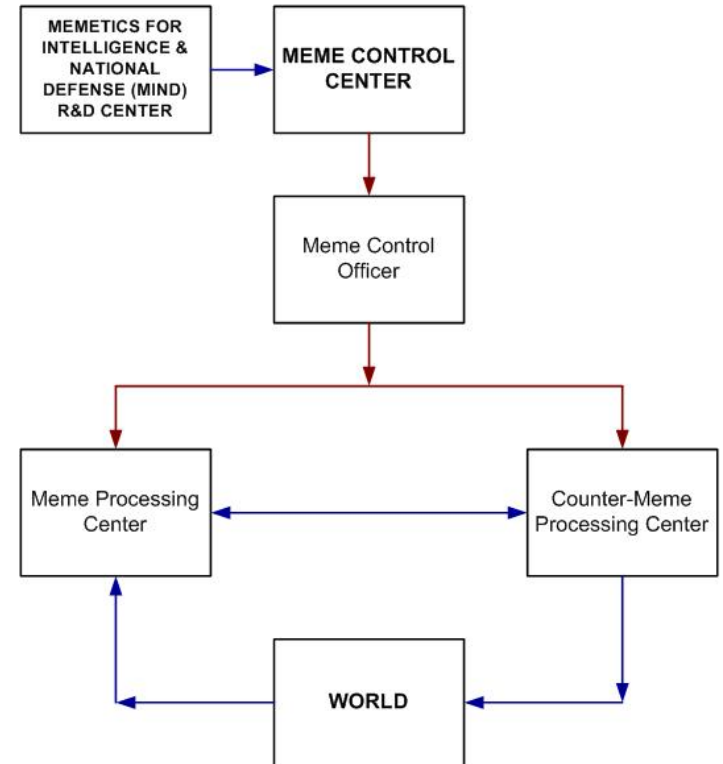



# MEMES AND CULTURE

- **Culture:** set of values (and the attitudes and beliefs generated by values) shared by a group
- **Values:** general criteria, standards, or guiding principles that people use to determine which types of behaviors, events, situations, and outcomes are desirable or undesirable; the basis for making a decision
  - **Terminal value:** a desired end state or outcome that people seek to achieve
  - **Instrumental value:** a desired mode of behavior
  - **Norms:** standards or styles of behavior that are considered acceptable or typical for a group of people
  - **Some values are genetically determined (i.e., nature); other values are environmentally (culturally) determined (i.e., nurture)**

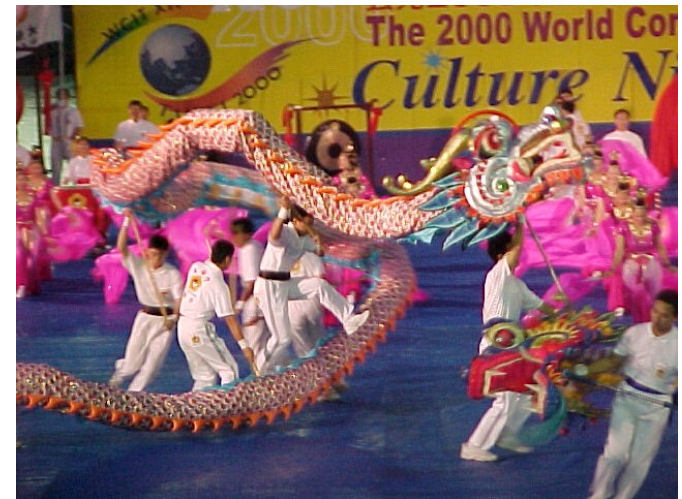

# MEMES AND CULTURE

- Culture sets the standards of behavior required for continued acceptance and participation in the group
  - The group might be a nation, ethnic group, religion, corporation, or other institution or organization
- Culture is based on common experiences and heritage
  - Example: food is often cultural – people tend to prefer the same daily fare they experienced as children
  - Example: religion is often cultural – people tend to prefer the same religion they experienced as children

CHINESE  
FOOD

BAGELS

BURRITOS

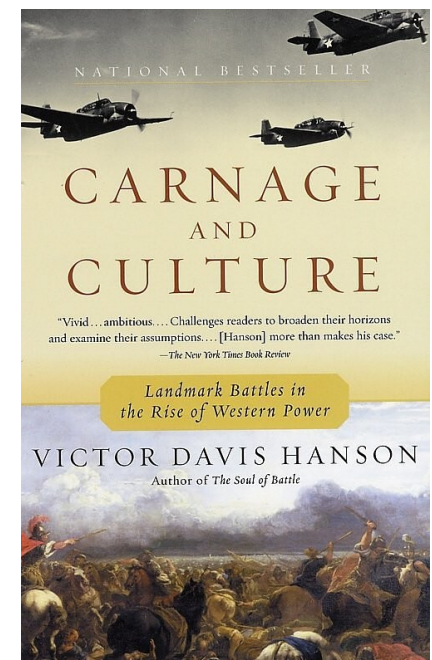

# MEMES AND CULTURE

- **Culture, as nurture, (partially) determines values**
- **Values are the bases of decisions**
- **Decisions lead to behavior**
- **Therefore, culture drives behavior**
  - **Examples:** preferences in food; religious practices; social interactions, transactions, and manners; choices of self-actualization and lifestyles; choice of marriage partners
- **Cultures develop like natural evolution, with punctuated equilibrium**
  - **Long static periods of little or no change, punctuated by dynamic intervals of rapid or revolutionary changes**

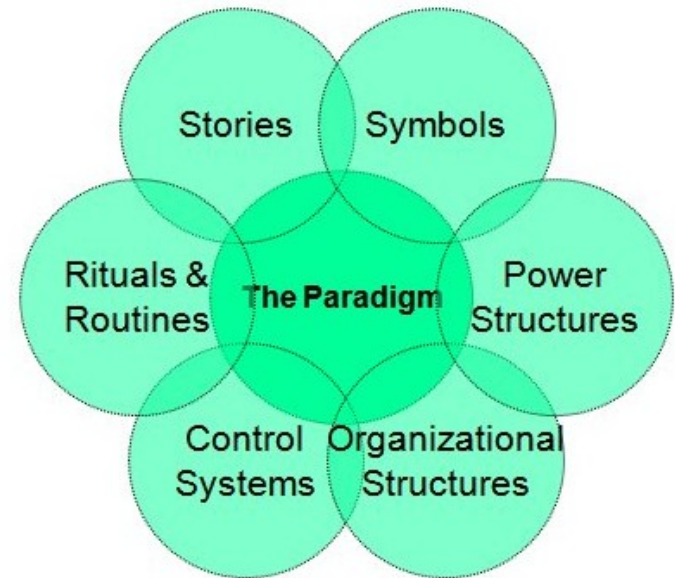



# MEMES AND CULTURE

- **Culture determines whether people will strive to better their condition or accept their lot as the will of God or fate**
- **Culture determines, in general:**
  - **How people work and play**
  - **Whether they prefer cooperation or competition, individuality or social conformity**
  - **How much they defer to authority**
  - **Whether they prefer tradition or change**
  - **How much they value education**
  - **Whether they prefer peace or war**
  - **Whether they tend to be optimistic or pessimistic**
  - **Whether they are sectarian or secular**
  - **Whether they prefer critical thinking or magical thinking**
  - **What and how they eat and drink**





# MEMES AND CULTURE

- Culture is passed on from generation to generation by behavioral examples of family, friends, and other members of the group (e.g., nation, tribe, sect)
- Culture is also shaped, exemplified, and propagated by memes and narratives (which are a type of meme)
  - Stories: oral, written, or multi-media
  - Aphorisms, fables, legends, mythology
  - Celebrated heroes and role models (historical and contemporary),
  - Iconic graphics (fine and popular art, paintings, statues, posters, prints, and advertising)
  - Catch phrases, exhortations, declarations, gossip, jingles, songs, speeches
  - Semiotics (signs and symbols)
- Narratives can strongly shape or modify a culture
  - Cultural narratives and strategic narratives



# MEMES AND NARRATIVES

- A narrative is a story: long or short; past, present, or future; with or without much detail; told for any purpose
  - A story has a beginning, middle, and (hopefully happy) ending
- Cultural narratives are important in forming and maintaining cultures (of nations or other groups), in giving a sense of identity and purpose to individuals within a culture
  - What is our past? Why are we here? What is our future?
- National strategic narratives describe the core interests of a nation and provide a foundation for statecraft and national security
  - Example: the U.S. post World War II strategic narrative provided the basis for the global struggle against communism
  - A post-communism narrative is needed for the global struggle against asymmetric adversaries



Woodrow Wilson International Center for Scholars

A National Strategic Narrative  
BY: MR. Y  
with preface by Anne-Marie Slaughter, Professor of Politics and International Affairs, Princeton University

WOODROW WILSON CENTER · 2011 · www.wilsoncenter.org

# MEMES AND NARRATIVES

- There is not yet a suitable narrative theory or narrative engineering to counter adverse individual and social behavior originating from narratives
  - Not yet an integrated system of tools and techniques for automating the ability to detect, identify, and evaluate narratives and for creating and propagating counter-narratives



# MEMES AND NARRATIVES

- **Research shows that narratives are fundamental to the human mind and perception**
  - **Sensory data and subsequent perception are intermittent, with only the illusion and delusion of continuity and coherence**
  - **Plagues with uncertainty and flawed information, the subconscious mind creates an illusion of a coherent narrative, constructing relationships, motives, and intentions based on limited or incorrect information**
  - **The mind fills in details and revises its narratives as needed, with or without evidence, even retroactively**
  - **The mind autonomically, unconsciously, and continuously constructs narratives, weaving the weft of subjective reality among the warp of physical reality**
  - **Thus individuals create personal stories about who they are and what the world is like; narratives by which they live their lives**
  - **These individual narratives can aggregate and evolve into cultural narratives influencing the behavior of the tribe or nation**

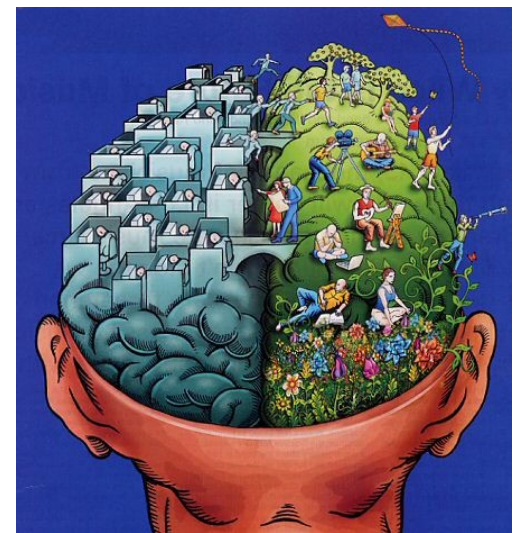



# MEMES AND NARRATIVES

- The structure, function, and ontology of narratives are shaped by their building blocks, including: metaphors, symbols, symbolic actions, semiotics, myths, frames, scenarios, etc.
- For example, metaphors shape and express cultural thought and style as embedded in language, artifacts, and behavior
  - They shape ideology and religion and can spark insurgencies
- The major sources of metaphor vary from culture to culture, whether the human body, animals, dwellings, landscapes, sport, war, etc.
  - Many cultures have common metaphors, i.e., identical mapping of metaphor sources into target domains; but seemingly identical metaphors might have different implications in different cultures
  - Examples: “Arab street” has negative connotations, including instability, irrationality, and violence; but “Arab spring” has positive connotations – the overthrow of tyrannical regimes

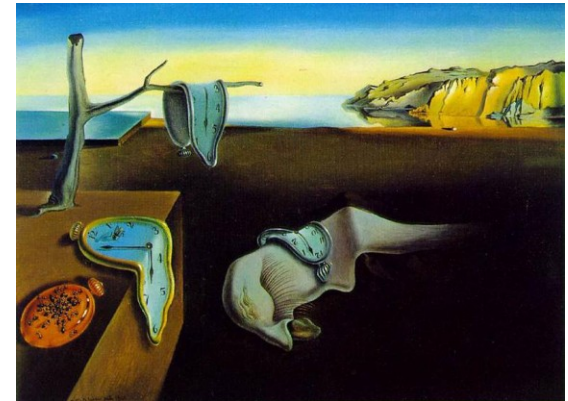

# MEMES AND CULTURE

- **Cultures and subcultures can be functional or dysfunctional or something in between**
  - **Cultural anthropologists are loath to judge the functionality – the value or worth – of cultures**
  - **Anyone judging a culture is from within a culture and thus deemed biased; such judgments are judged too subjective**
- **If dysfunctional cultures and subcultures can be properly identified and evaluated, they can be enhanced**
- **Memetics can be used to enhance dysfunctional cultures and subcultures**

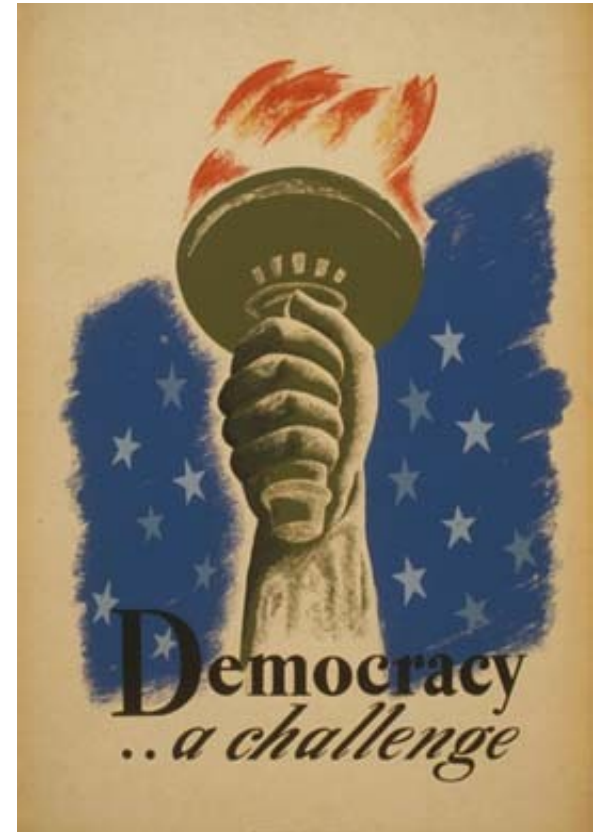

# MEMES AND CULTURE

- **Maslow's Hierarchy of human needs and wants can provide a reasonable basis for developing metrics to evaluate the degree to which a culture is dysfunctional**
  - **Maslow was immersed in American culture, so his hierarchy can be criticized for its composition and characterization of relative importance**
  - **The specified needs and wants are nevertheless generally valid, if not for every individual or culture**
  - **The relative importance of some needs and wants can be shifted without invalidating the ability to identify dysfunctional cultures or subcultures**



# MEMES AND CULTURE

- **Maslow's Hierarchy of Human Needs and Wants**
  - **Physiological:** air, water, food, clothing, shelter
  - **Safety:** personal security, economic security, health (physical and mental)
  - **Social:** relationships and sense of belonging (family, friends, neighbors, society, spiritual)
  - **Esteem:** self-respect and respect by others (e.g., status, recognition, fame, prestige, attention; strength, competence, mastery, self-confidence, independence, and freedom)
  - **Self Actualization:** achieve one's full potential
- **To the extent that a culture or subculture provides these needs and wants it is functional – or dysfunctional**
  - **Metrics can be developed and cultures can be evaluated**
- **Dysfunctional cultures can be changed with memetics**

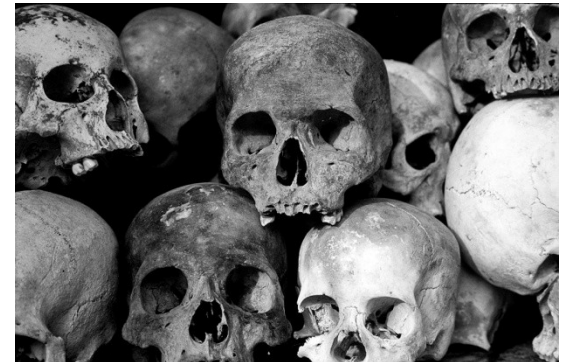



# MEMETICS AND TRUE BELIEVERS

- The dynamics of mass movements and “True Believers” have significant implications for memetics
- In the 21st century the true believer still infests the world in every nation and culture, whether of ideological, religious, social, or political orientation
  - If anything, the threat from the True Believer seems greater now than it has been in since World War II
  - Mass movements of all sorts, good and bad, have altered history over the centuries - they were particularly bloody in the 20th century, and they are with us to the present moment
- Eric Hoffer, the longshoreman philosopher of the mid-twentieth century, expounded his views of this phenomena in his 1951 book *“The True Believer: Thoughts on the Nature of Mass Movements”*
- Following are excerpts from Hoffer that I have paraphrased or interpreted as aphorisms (occasionally injecting my own views) – and which offer clues to the design of effective memes



# MEMETICS AND TRUE BELIEVERS

- *True believers are functionally identical*
  - **Regardless of the causes people die for, they die for basically the same thing**
  - **While all mass movements are taxonomically equivalent, not all mass movements are equally good or evil**
  - **We must know all we can about the nature and potentialities of the true believer**
  - **The true believer is everywhere on the march, shaping the world in his image by both converting and antagonizing**

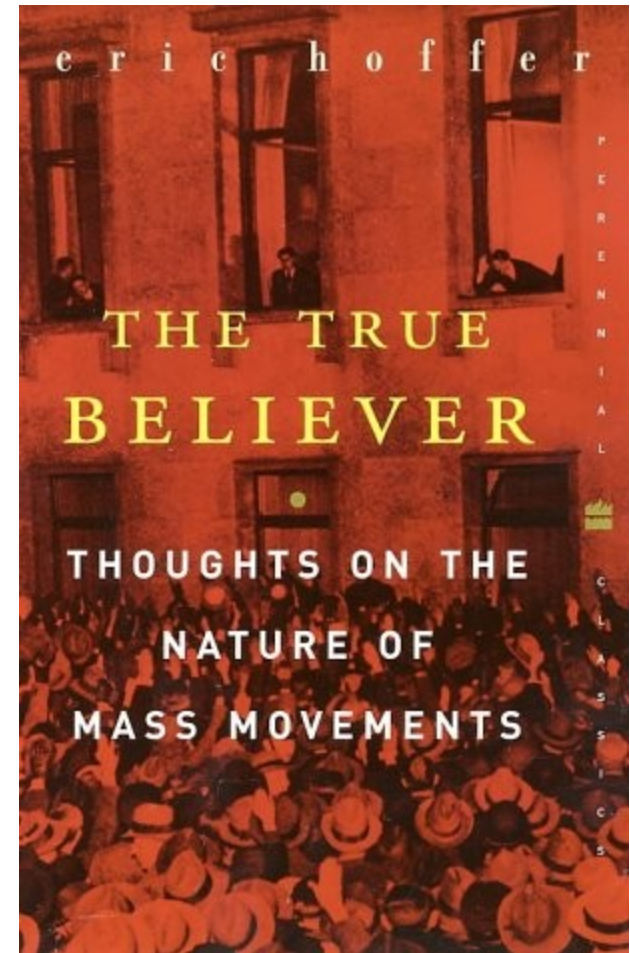

# MEMETICS AND TRUE BELIEVERS

- *True believers arise primarily from the among frustrated*
  - The frustrated predominate among the early adherents of all mass movements, and they join of their own accord, without the need for proselytizing from the outside
  - Frustration alone can generate most of the peculiar characteristics of the true believer, including readiness to sacrifice his life for a holy cause
  - A proselytizing mass movement deliberately fosters in its adherents a frustrated state of mind, increasing the propensities of the frustrated
  - While those with a sense of fulfillment want to conserve the world as it is, the frustrated favor radical change
  - To the frustrated the present is irremediably spoiled so that only hope provides comfort





# MEMETICS AND TRUE BELIEVERS

- *True believers are drawn primarily by hope*
  - Extravagant hope, even when not backed by actual power, is likely to generate a most reckless daring; for the hopeful can draw strength from the most ridiculous sources of power – a slogan, a word, a button
  - There is a difference between immediate hope and distant hope: a rising mass movement preaches immediate hope that prompts people to act, but an established mass movement is preoccupied with preservation of the present, prizing obedience and patience over spontaneous action, and thus preaches distant hope as an opium to dull the impatience of the masses and reconcile them with their lot in life





# MEMETICS AND TRUE BELIEVERS

- *True believers are drawn primarily by hope*
  - If a movement (e.g., Al Qaeda) wins a chunk of the world, it is not because they know how to stir up discontent or how to infect people with hatred, but because they know how to preach hope
  - One of the most potent attractions of a mass movement is its offering of a substitute for individual hope
  - The unemployed are more likely to follow the peddlers of hope than the handers-out of relief
  - Those who would transform a nation or the world cannot do so by breeding and captaining discontent or by demonstrating the reasonableness and desirability of the intended changes or by coercing people into a new way of life – they must know how to kindle and fan extravagant hope, and it matters not whether it be hope of a heavenly kingdom, of heaven on earth, of plunder and untold riches, or fabulous achievement or world dominion



# MEMETICS AND TRUE BELIEVERS

- *Give the powerless a sense of power as well as hope for the future*
  - Those who plunge into movements of vast social change feel they possess some irresistible power, whether based on notions of reason and intelligence (e.g., the French revolution), political ideology (e.g., Marxism), religion (e.g., Christianity and Islam), or nationalistic mythology (e.g., Nazism)
  - An effective doctrine, as well as being a source of power, must also claim to be a key to the book of the future; faith in the future is even more important than the instruments of power for driving change



# MEMETICS AND TRUE BELIEVERS

- *Give the powerless a sense of power as well as hope for the future and self-esteem*
  - To plunge into an undertaking of vast change, people must be intensely discontented yet not destitute, and they must have the feeling that by possession of some potent doctrine, infallible leader, or some new technique, they have access to a source of irresistible power – they must also have an extravagant conception of the prospects and potentialities of the future and must be wholly ignorant of the difficulties in their vast undertaking (experience is a handicap)
  - Take away our holy duties and our lives become puny and meaningless; in exchanging a self-centered for a selfless life we gain enormously in self-esteem – and the vanity of the selfless, even those who practice utmost humility, is boundless

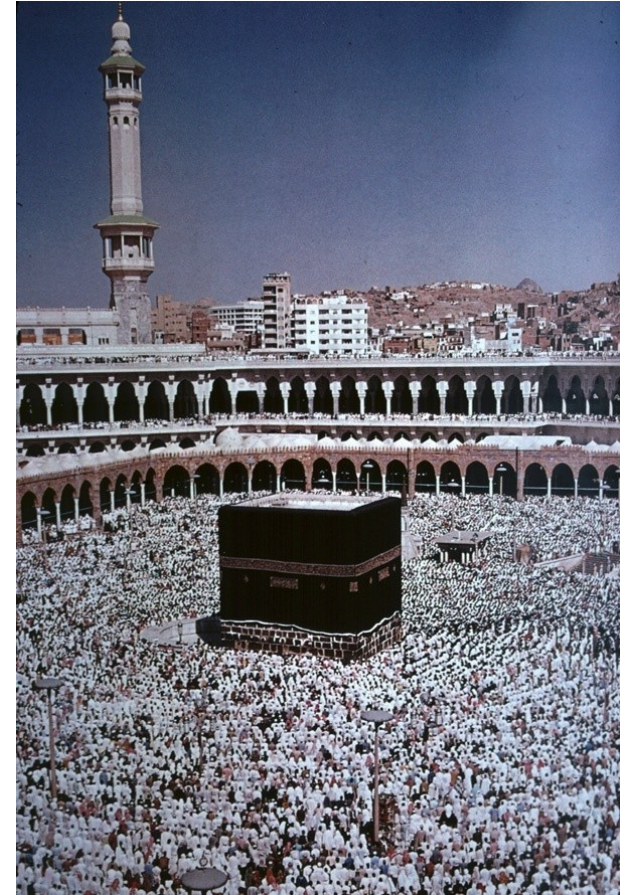



# MEMETICS AND TRUE BELIEVERS

- *The true believer is willing to die for his belief*
  - When individual interests and prospects do not seem worth living for, then one seeks worth and meaning in all forms of dedication, devotion, loyalty, and self-surrender – the embracing of a substitute will necessarily be passionate and extreme, the faith in nation, religion, race, or holy cause will be extravagant and uncompromising
  - We cannot be sure we have something worth living for unless we are ready to die for it
  - The readiness to die is evidence, to themselves and others, that those who have taken a substitute for an irrevocably missed or spoiled first choice is indeed the best there ever was

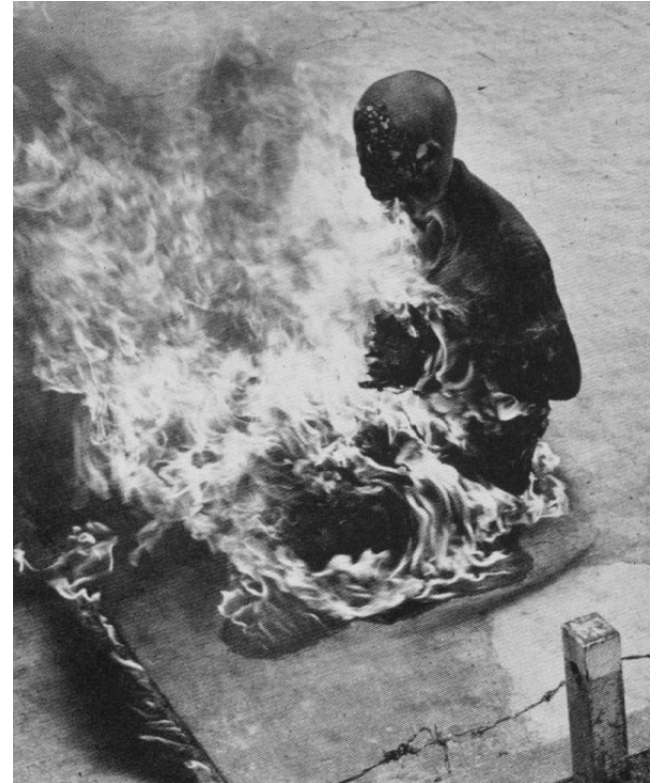



# MEMETICS AND TRUE BELIEVERS

- *All true-believer mass movements are taxonomically equivalent*
  - **When people are ripe for a mass movement, they are usually ripe for any effective movement, not solely for one with a particular doctrine or program**
  - **The receptivity to all movements does not always cease even after the potential true believer has become the ardent convert of a specific movement**



# MEMETICS AND TRUE BELIEVERS

- Each proselytizing mass movement seems to regard the zealous adherents to its antagonist as its own potential converts
- Since all mass movements draw their adherents from the same types of humanity and appeal to the same types of mind, it follows: (1) all mass movements are competitive, and the gain of one in adherents is a loss of all the others; (2) all mass movements are interchangeable and transformable (so that a religious movement may develop into a social revolution or a nationalistic movement; a social revolution may transform into militant nationalism or a religious movement; and nationalist movement may transform into a social revolution or a religious movement)
- It is rare for a mass movement too be wholly of one character; it usually displays some facets of other types of movement, and sometimes it is two or three movements in one (such as religious, social, and nationalistic)
- The problem of stopping a mass movement is often a matter of substituting one movement for another
- A religious revolution can be stopped by promoting a social or nationalistic movement





# MEMETICS AND TRUE BELIEVERS

- It is usually the newly poor, often from a ruined middle class, who ferment with frustration at the memory of relative affluence and who respond to every rising mass movement
- **The chronically unemployed feel degraded, disinherited, and injured by an unjust order of things and will to listen to instigators of mass movements**
- The poor on the borderline of starvation live purposeful lives desperately struggling for survival; with every meal a triumph, they are immune to the appeal of a mass movement
- **Misery does not automatically generate discontent, nor is the intensity of discontent directly proportionate to the degree of misery**
- **Discontent is likely to be highest when misery is bearable; when conditions have so improved that an ideal state seems almost within reach**





# MEMETICS AND TRUE BELIEVERS

- Unless a person has the talent for achievement, freedom is an irksome burden; people join a mass movement to escape individual responsibility, to be free from freedom



# MEMETICS AND TRUE BELIEVERS

- The most fertile ground for a mass movement is a society with considerable freedom but lacking in the palliatives of frustration
- Even mass movements which rise in the name of freedom against an oppressive order do not realize individual liberty once they start rolling – its chief preoccupation will be unity and self-sacrifice, which requires surrender of the individual's will, judgment, and advantage
- Fanatics fear liberty more than they fear persecution



# MEMETICS AND TRUE BELIEVERS

- Those who see their lives as spoiled and wasted crave equality and fraternity more than they do freedom
- Where freedom is real, equality is the passion of the masses; where equality is real, freedom is the passion of a small minority
- Equality without freedom creates a more stable social pattern than freedom without equality
- A rising mass movement attracts and holds a following not by its doctrine and promises but by the refuge it offers from the anxieties, barrenness, and meaninglessness of an individual existence
- Where new creeds vie with one another for the allegiance of the populace, the one which comes with the most perfected collective framework wins
- The fiercest fanatics are often selfish people who were forced, by innate shortcomings or external circumstances, to lose faith in their own selves; they separate the instrument of their selfishness and attach it to the service of some holy cause
- The inordinately selfish are likely to be the most persuasive champions of selflessness





# MEMETICS AND TRUE BELIEVERS

- In their earliest stages, mass movements are more likely to find sympathizers and support among the bored than among the exploited and oppressed
- Fervent patriotism as well as religious and revolutionary enthusiasm often serves as a refuge from a guilty conscience
- The technique of a proselytizing mass movement aims to evoke in the faithful the mood and frame of mind of a repentant criminal
- The technique of a mass movement aims to infect people with a malady and then offer the movement as a cure
- The vigor of a mass movement stems from the propensity of its followers for united action and self-sacrifice
- The success of a mass movement, usually ascribed to its faith, doctrine, propaganda, leadership, ruthlessness, etc., actually arises from its instruments of unification and the means used to inculcate a readiness for self-sacrifice



# MEMETICS AND TRUE BELIEVERS

- The angst of the frustrated stems from a consciousness of an irredeemably blemished self; the desire to escape that self is manifested in a propensity for united action and self-sacrifice
- The capacities for united action and self-sacrifice almost always go together; a group that is particularly contemptuous of death is usually close-knit and thoroughly unified
- To ripen a person for self-sacrifice he must be stripped of his individual identity, most drastically by complete assimilation of the individual in the collective body
- The individual fully assimilated into the collective never feels alone; to be cast out from the group is the equivalent of being cut off from life
- The collectivized individual is in a primitive state of being, equivalent to that in primitive tribes – mass movements strive to approximate this primitive perfection



# MEMETICS AND TRUE BELIEVERS

- The capacity to resist coercion, torture, or annihilation stems partly from the individual's identification with a group; individualists crush easily
- Dying and killing seem easy when they are part of a ritual, ceremonial, dramatic performance, or game; there is a need for some kind of make-believe to face death unflinchingly
- One of the main tasks of the leader of a mass movement is to mask the grim reality of dying and killing by evoking in his followers the illusion that they are participating in a grandiose spectacle, a solemn or light-hearted dramatic spectacle
- Glory is largely a theatrical concept which requires a vivid awareness of an audience (and a definition of terrorism is the act of violence, or the threat of violence, against non-combatants to influence an audience)
- In the practice of mass movements, make-believe plays perhaps a more enduring role than any other factor; when faith and the power to persuade are gone, make-believe lingers on





# MEMETICS AND TRUE BELIEVERS

- Once the mass movement starts rolling, the present is shoved off the stage and its place taken by posterity; the battle line is drawn between things that are and have been, and the things that are not yet
- **To lose one's life in a defiled, worthless present is not to lose much**
- The mass movement decries pleasures and comforts and extols the rigorous life, fashioning individual existence as dour, hard, repressive, and dull; ordinary enjoyment is deemed trivial or discreditable, and the pursuit of individual happiness is immoral
- **The very impracticality of many of the goals which a mass movement sets itself is part of the campaign against the present – all that is practical, feasible, and possible is part of the present**
- All mass movements deprecate the present by depicting it as a mean preliminary to a glorious future, a mere doormat on the threshold of the millennium



# MEMETICS AND TRUE BELIEVERS

- To a religious movement, the present is a place of exile, a vale of tears leading to the heavenly kingdom; to a social revolution it is a mean way station on the road to Utopia; to a nationalist movement it is an ignoble episode preceding the final triumph
- Possessed of a vivid vision of past and future, the true believer sees himself as part of something that stretches endlessly backward and forward, something eternal; he can sacrifice his life because it is not the beginning and end of all things

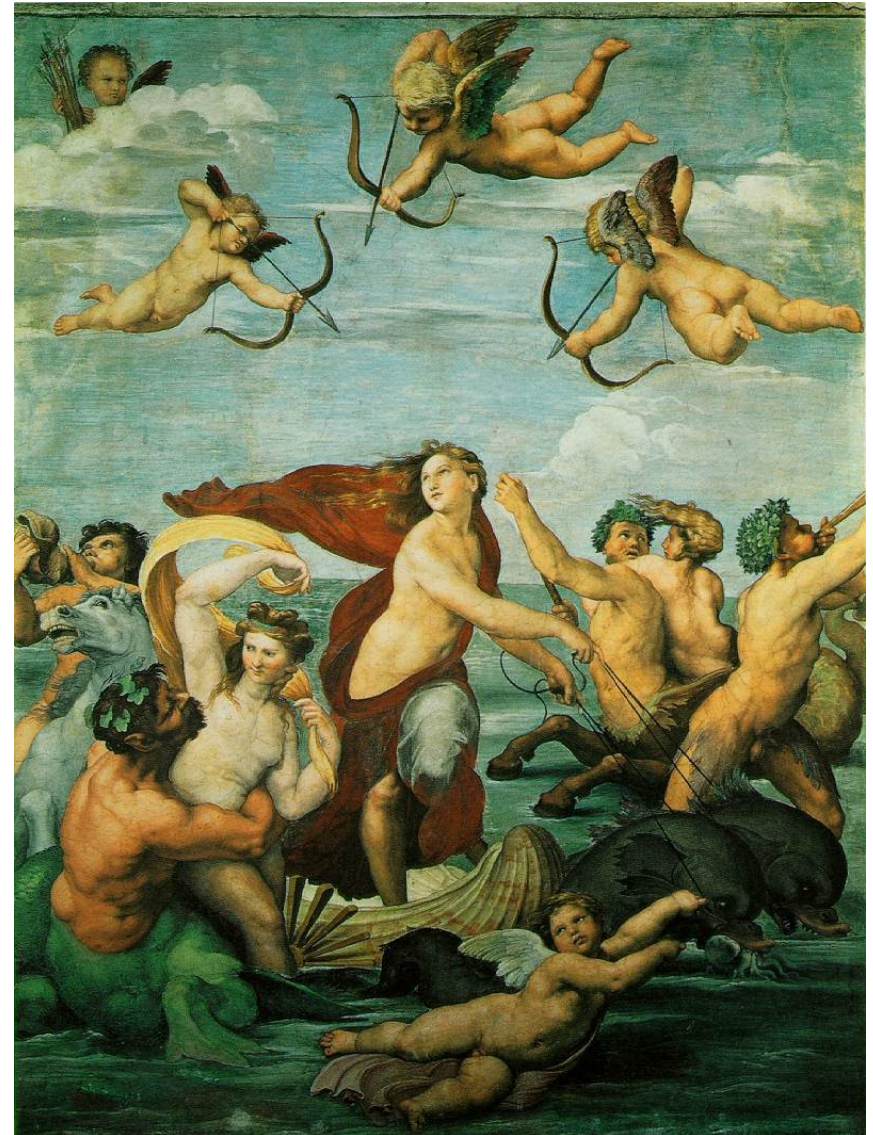



# MEMETICS AND TRUE BELIEVERS

- The frustrated derive as much satisfaction (if not more) from the means a mass movement uses as from the ends it advocates; chaos and destruction are at least as satisfying as that which will follow
- People are less ready to die for what they have or are than what they wish to have or become
- Self-sacrifice is an unreasonable act; so all mass movements strive to interpose a fact-proof screen between the faithful and the realities of the world by claiming that absolute truth is already embodied in their doctrine and there is neither truth nor certitude outside it





# MEMETICS AND TRUE BELIEVERS

- It is the certitude of his infallible doctrine that renders the true believer impervious to the uncertainties, surprises, and unpleasant realities of the world around him
- In order to be effective a doctrine must not be understood, but rather has to be believed – we can be absolutely certain only about things we do not understand
- The devout are always urged to seek the absolute truth with their hearts and not their minds; when a movement begins to rationalize its doctrine and make it intelligible, it is a sign that its dynamic span is over and that it is interested primarily in stability

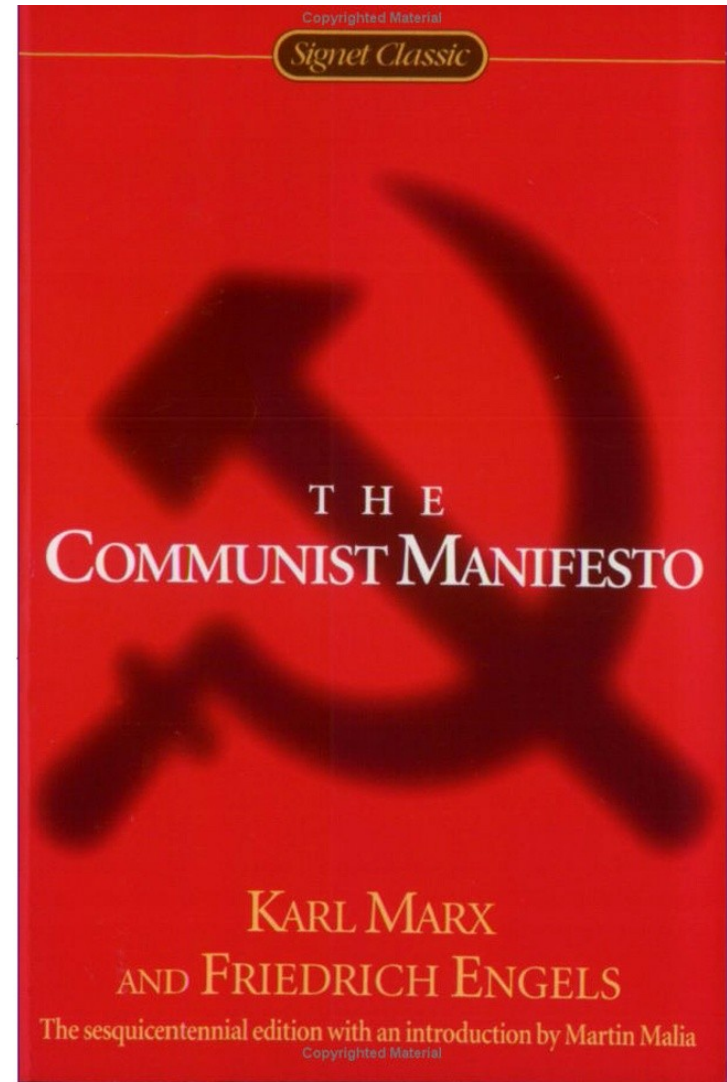

# MEMETICS AND TRUE BELIEVERS

- If a doctrine is not unintelligible it has to be vague; and if neither unintelligible nor vague, it has to be unverifiable – one has to get to heaven or the distant future to determine the truth of an effective doctrine
- There is an illiterate air about the most literate true believer, using words as if he were ignorant of their true meaning; hence his taste for quibbling, hair-splitting, and scholastic tortuousness
- The true believer is without wonder and hesitation; the true doctrine is the master key to all the world's problems

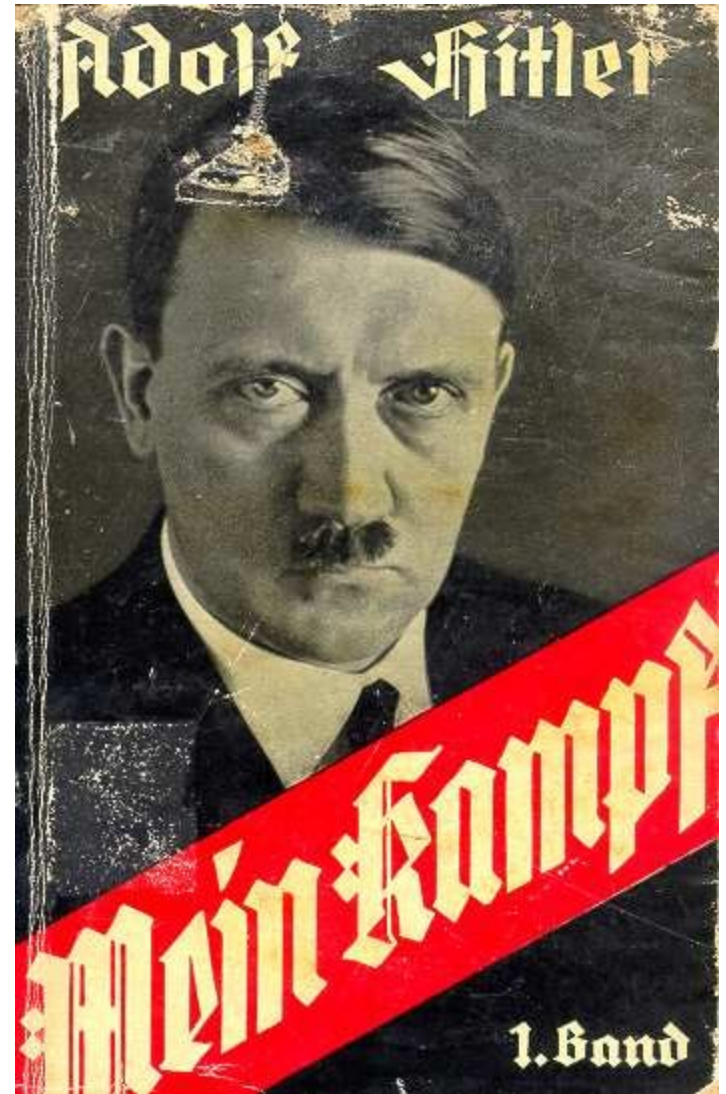

# MEMETICS AND TRUE BELIEVERS

- The fanatic is not a stickler to principle – he embraces a cause not primarily because it is just or holy but because he has a desperate need to hold onto something
- **The fanatic can swing suddenly and wildly from one cause to another**
- Fanatics of all kinds are similar to one another, at one end of the pole despite seemingly at opposite ends of religious, social, or ideological poles
- **The radical and reactionary have more in common than either has with the liberal or conservative**
- Hatred is the most accessible and comprehensive of all unifying agents
- **Mass movements can rise and spread without belief in a God, but never without belief in a devil**
- Common hatred unites the most heterogeneous elements, even erstwhile enemies





# MEMETICS AND TRUE BELIEVERS

- The genius of a great leader consists in concentrating all hatred on a single foe, making even adversaries far removed from one another seem to belong to a single category
- The ideal devil is a foreigner; to qualify as a devil, a domestic enemy must be given a foreign ancestry
- A sublime religion inevitably generates a strong feeling of guilt (given the disparity between the lofty doctrine and the imperfect practice), and the feeling of guilt promotes hate and brazenness
- The more sublime the faith, the more virulent the hatred it breeds
- The influence of the fanatic is out of all proportion to his abilities; by converting and antagonizing he shapes the world to his own image (such as causing democracies to become zealous, intolerant, and ruthless)
- Hatred is a convenient instrument for mobilizing a community for defense, but we often pay for it by losing all or many of the values we have set out to defend



# MEMETICS AND TRUE BELIEVERS

- Part of the attractiveness of the mass movement to its adherents is the emergence of a new freedom from the loss of individual judgment: the freedom to hate, bully, lie, torture, murder, and betray without shame or remorse
- **Hatred is not only a means of unification but also its product**
- **Imitation is an essential unifying agent**
- **The one-mindedness prized by every mass movement is achieved as much by imitation as obedience**
- **There is a connection between frustration and the readiness to imitate – the frustrated imitate to search for a new identity or camouflage their individual distinctness, to be like others**
- **The ready imitativeness of a unified following is both an advantage and a peril to a mass movement: while the faithful are easily led and molded, they are also particularly susceptible to outside influences – a unified group is easily seduced and corrupted**



# MEMETICS AND TRUE BELIEVERS

- The preaching of all mass movements warns against copying foreign models – the imitation of outsiders is branded as treason and apostasy
- Contempt for the outside world is the most effective defense against disruptive imitation – every device is used to cut off the faithful from interaction with unbelievers
- We tend to exaggerate the effectiveness of persuasion as a means of inculcating opinion and shaping behavior – we falsely attribute to propaganda the startling successes of mass movements
- Propaganda on its own cannot force its way into unwilling minds; neither can it inculcate something new; nor can it keep people persuaded once they have ceased to believe
- Propaganda penetrates only into minds already open, articulating and justifying opinions already present in the minds of its hearers
- Where opinion is not coerced, people can be made to believe only in what they already “know”





# MEMETICS AND TRUE BELIEVERS

- Propaganda by itself succeeds mainly with the frustrated
- Even skillful propaganda cannot keep people persuaded once they have ceased to believe – force must then be used for the mass movement to maintain itself
- Propaganda becomes more fervent and importunate when it operates in conjunction with coercion than when it has to rely solely on its own effectiveness
- Propaganda serves more to justify ourselves than to convince others; the proselytizing terrorist must reinforce the conviction that his faith is the only true one or he will feel himself to be a criminal
- The more blood the terrorist sheds, the more he needs to believe in his principles as absolutes – only the absolute will absolve him in his own eyes
- The practice of terror serves the true believer not only to cow and crush his opponents, but also to invigorate and intensify his own faith



# MEMETICS AND TRUE BELIEVERS

- Where a mass movement can either persuade or coerce, it usually chooses the latter
- Force can stop and crush even the most vigorous mass movement, but to do so the force must be ruthless and persistent
- Ruthless and persistent force can only come from fanatical conviction – the violence needed to counter a mass movement must spring from a spiritual base to avoid being wavering and uncertain (fanaticism is needed to counter fanaticism)
- The proselytizing fanatic strengthens his own faith by converting others – the creed whose legitimacy is most easily challenged is likely to develop the strongest proselytizing impulse
- The leader cannot create the conditions which make the rise of a mass movement possible – he cannot conjure a movement out of the void
- There has to be an intense dissatisfaction and an eagerness to follow before the movement and the leader can make their appearance



# MEMETICS AND TRUE BELIEVERS

- Once the stage is set, the presence of an outstanding leader is indispensable – without the leader there will be no movement
- It needs the iron will, daring, and vision of an exceptional leader to concert and mobilize existing attitudes and impulses into the collective drive of a mass movement and kindle the vision of a breathtaking future
- The quality of ideas seems to play a minor role in mass movement leadership – what counts is the arrogant gesture, the complete disregard of the opinions of others, the single-handed defiance of the world
- Charlatanism of some degree is indispensable to effective mass movement leadership; there can be no mass movement without some deliberate misrepresentation of facts
- The true believer, no matter how lawless and violent his acts, is basically an obedient and submissive person





# MEMETICS AND TRUE BELIEVERS

- The literati and intellectuals often set the stage for the fanatics
- There is a moment (before he formulates a philosophy and a program) when the articulate finder of fault may be won over by a deferential or conciliatory gesture from those in power
- A mass movement is pioneered by articulate intellectuals, materialized by fanatics, and consolidated by leaders of action (usually different people, men or women, play these roles in succession, as conditions require)
- The leader of action saves the movement from the suicidal dissensions and recklessness of the fanatics, marking the end of the dynamic phase of the movement
- The leader of action fixes and perpetuates the mass movement's unity and readiness for self-sacrifice, relying mainly on drill and coercion but preserving as a façade the earlier enthusiasm of faith
- At the end of its vigorous span, the mass movement is an instrument of power for the successful and an opiate for the frustrated

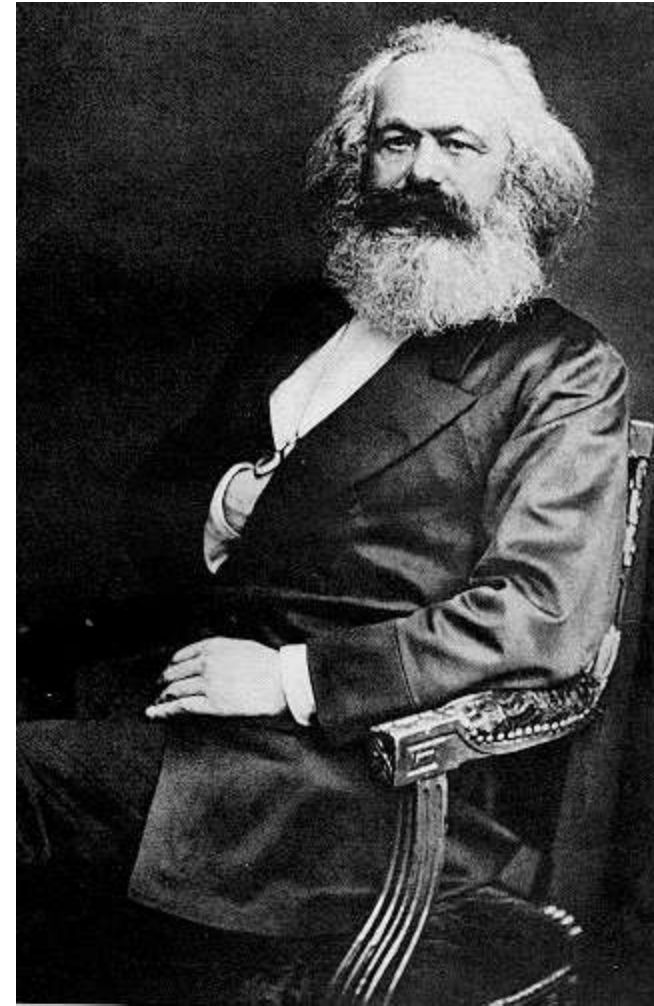

# MEMETICS AND THE TIPPING POINT

- **“The Tipping Point,”** Malcolm Gladwell (2002): how ideas, products, messages, and behavior spread like viruses – **the moment when everything changes all at once**
- **Contagious behavior (e.g., viral marketing)**
  - **Small number of people in small number of situations start behaving differently and that behavior spreads and changes the behavior of others in similar situations**
    - **Examples:** trends in: fashion, crime or anti-crime, music, fads, religion, ideology
- **Small changes can have big effects**
  - **A few percent change in initial conditions can lead to non-linear outcomes (like a single match with limited energy can start a forest fire)**
- **Changes can occur quickly, not gradually (e.g., epidemics or punctuated equilibrium in evolution)**

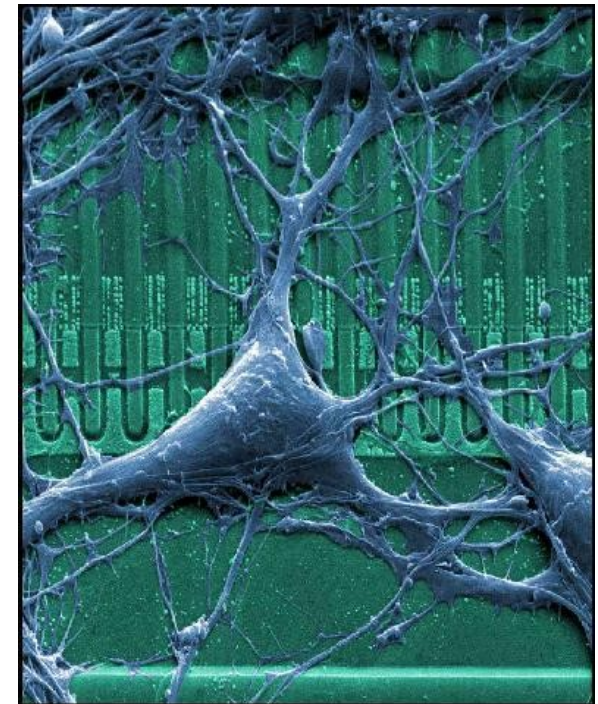
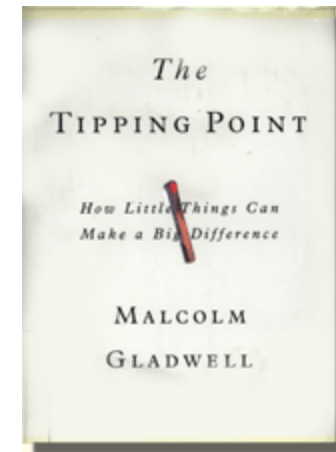

# MEMETICS AND THE TIPPING POINT

- People are conditioned for linearity and gradualness, not exponential or geometric progression
  - But social change can be as sudden as the phase change of rain to snow
- The 95/5 rule (a more extreme version of the 80/20 rule): 5% of people cause 95% of new ideas to spread
- Stickiness in messages (sticks in memory and has impact)
  - Simple changes in presentation or structuring of information can make a big difference in impact
    - Examples: “Winston Tastes Good Like a Cigarette Should” (1954)
    - “It Takes a Licking and Keeps on Ticking” (1956)
    - “Good to the Last Drop” (1926)





# MEMETICS AND THE TIPPING POINT

- **Three rules of the Tipping Point**
  - (1) **The law of the few: few people can cause large effects (e.g., changes in mass behavior)**
  - (2) **The stickiness factor: message stays in memory**
  - (3) **The power of context: impact on behavior depends on context**

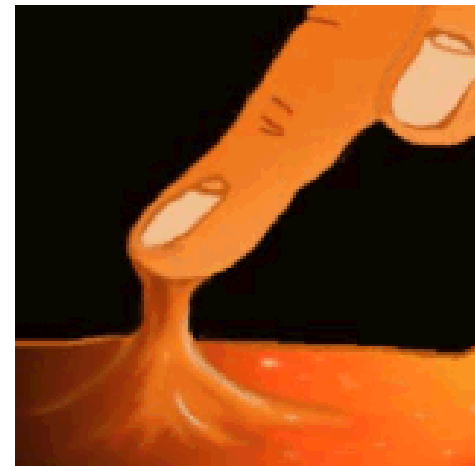

# MEMETICS AND THE TIPPING POINT

## ➤ The Law of the Few

- **Starting an information epidemic requires concentrating resources on a few key areas**
- **Success of social epidemic heavily depends on involvement of three types of people:**
  - **“Connectors”**: gregarious and know many people, active in many different social and professional niches and subcultures
  - **“Mavens”**: experts, socially motivated to share information
  - **“Salesman”**: persuaders, articulate and inherently good at convincing others after rapidly obtaining their trust and support
- **Mavens generate the message, Connectors spread it, and Salesmen persuade the unconvinced to heed the message**



# MEMETICS AND THE TIPPING POINT

- **Stickiness: message should be made practical and personal**
  - Information should be packaged in a simple way to make it irresistible
- **Context**
  - Behavior is a function of social context
  - Little things matter
  - When interpreting the behavior of others, people overestimate the importance of fundamental character traits and underestimate the importance of situation and context
    - Humans are more attuned to personal cues than contextual cues (a simpler, but inaccurate, description of reality)
  - Groups have a critical role in social epidemics





# MEMETICS AND THE TIPPING POINT

- To bring about a fundamental change in people's belief and behavior, a change that would persist and serve as an example to others, a community must be created around the beliefs
  - For groups to serve as incubators of messages (or ideas) they should be kept below 150 members (the maximum size for informal, person-to-person contact and cohesive group loyalty (e.g., an Infantry Company))
  - Larger groups spontaneously become divided and alienated
- To create one contiguous movement (e.g., an "epidemic"), first create many small movements



# MEMETICS AND THE TIPPING POINT

- **Rumor: most contagious of all social messages**
- **Kernel of truth in rumor (or urban legend) is distorted in 3 directions:**
  - **(1) Level story** (i.e., leave out details essential for understanding true meaning of incident)
  - **(2) Sharpen story** (i.e., make remaining details more specific)
  - **(3) Assimilate story** (i.e., change story so it makes sense to those spreading the rumor)
  - **Example:** rumors of 9/11
- **Mavens, Connectors, and Salesmen make an idea contagious by dropping extraneous details and exaggerating other details so that message acquires a deeper meaning and is better understood by the intended recipients**

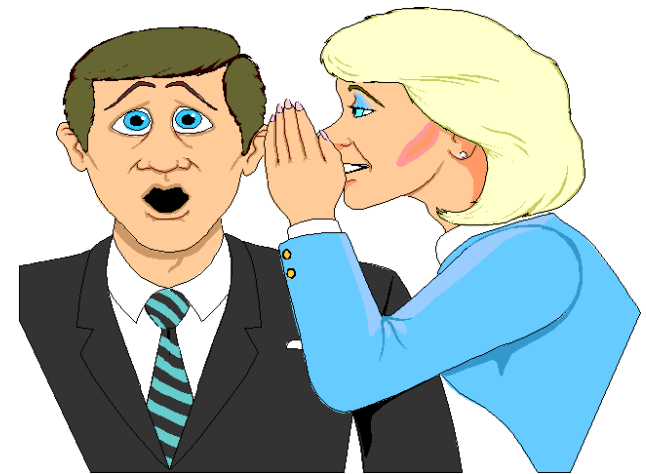

# MEMETICS AND THE TIPPING POINT

- **Suicide is contagious**
  - **In Micronesia, suicide among young males went from near zero to highest rate in world (7 times higher than U.S.)**
    - **Triggered by minor incident, suicide rituals became embedded in local culture, an important form of self-expression, imitated by younger and younger boys**
  - **In the U.S., newspaper stories of suicides temporarily increase suicide rates in local or national coverage area**
- **Influence of peers is more important than parents in shaping personality and intelligence**

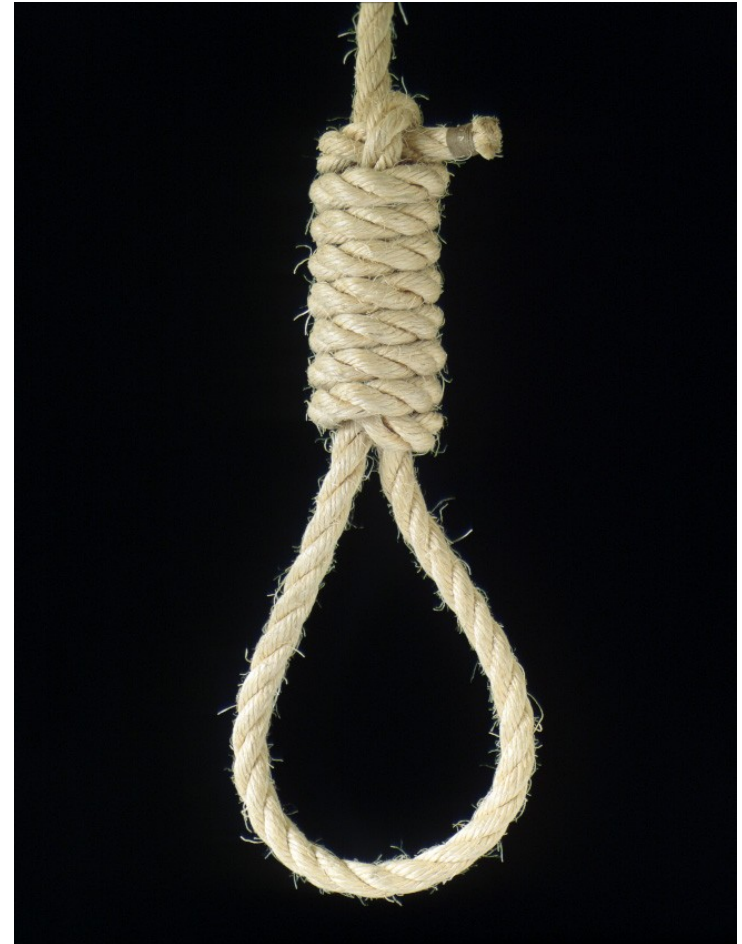



# MEMETICS AND THE TIPPING POINT

- People can transform behavior or beliefs with the right impetus
- **Seemingly intransigent, implacable people can be tipped with the slightest push in the right place at the right time**
- Social change is volatile and often inexplicable because people are naturally volatile and inexplicable



ATTACK ON A POTATO STORE.



# NEUROECONOMICS AND MEMETICS

## ➤ Neuroeconomics

- The study of how the brain interacts with the external environment to make choices (decisions)
  - Examples: Choices among competing alternatives; strategic choices with other individuals; choices under uncertainty, etc.
- Combines neuroscience, economics, and psychology
- Examines role of the brain in evaluating decisions, categorizing risks and rewards
- Focuses on high-level concepts of personal choices and decisions, and how these are represented in neurons and biochemistry



# NEUROECONOMICS AND MEMETICS

- **Neuroeconomics: More Definitions**
  - **An interdisciplinary research program with the goal of building a biological model of decision making in economic environments**
  - **Neuroeconomics is a subset of economics that focuses on personal choices and decisions and mental changes that correlate with the choices (and may cause them)**
  - **Neuroeconomics is a subset of psychology that focuses on thought about choices (especially the cognition for understanding and choosing options)**

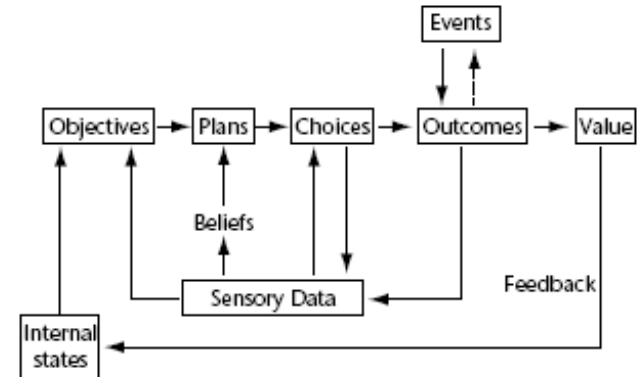

**Steps In Decision Making**

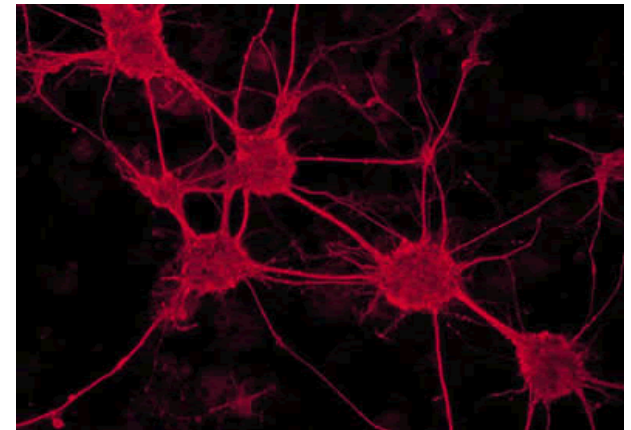



# NEUROECONOMICS AND MEMETICS

- **Experimental focus includes studies of:**
  - **Game theory, risk, attention and awareness, learning, valuation, motivation, emotion, behavior, trust and attachment, and addictive behavior**
- **Experimental methodologies include:**
  - **Neuroimaging (MRI), genetic profiling, psychopharmacological manipulations, psychophysiology (EMG, ERP, and EEG), behavioral measures, psychological testing, blood chemistry (and hormone) analysis, and single neuron recording, among others**
- **New field of neuromarketing investigates:**
  - **Product branding, preference, and purchase decisions using neuroscientific techniques**
  - **Experiments confirm that emotions are an important factor in many choices**
- ***Memetics research can leverage research in neuroeconomics***

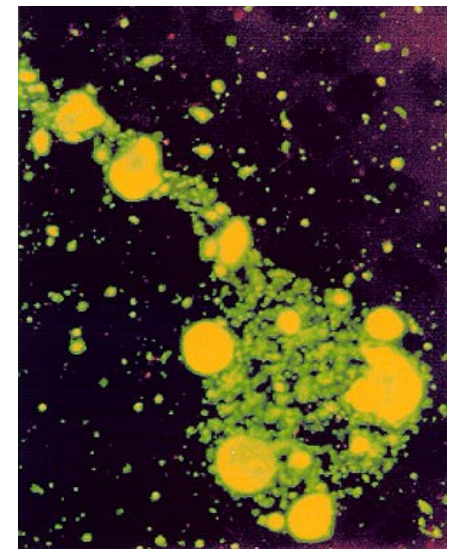
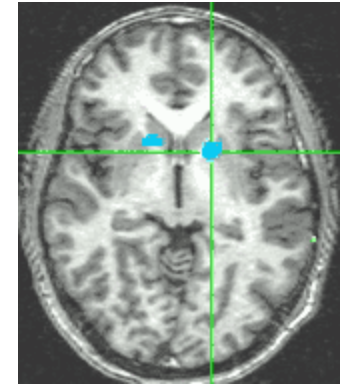

# MEMETICS: IMPLICATIONS FOR INTELLIGENT MACHINES

- **Intelligent machines can far exceed biological intelligence in memetic behavior**
  - **Information (Entropy)**
    - **Example:** large to small almost functionally equivalent
  - **Propagation**
    - **Example:** global dispersion and mind-to-mind at speed of light, with very high accuracy
  - **Impact**
    - **Example:** behavioral responses can be immediate for the individual or the collective
  - **Persistence**
    - **Example:** indefinite duration of transmission and memory, with very high accuracy



# POTENTIAL NATIONAL SECURITY USERS

- **Central Intelligence Agency**
- **U.S. Army Civil Affairs and Psychological Operations Command**
  - **Reserve Psyops Units**
- **Naval Network Warfare Command (NETWARCOM)**
- **Air Force Psyops Commands**
- **Joint Forces MILDEC**
- **Joint Forces Information Operations**
- **Defense Intelligence Agency**
- **Public Affairs (all services)**
- **Recruitment (all services)**
- **Training (all services)**





# TOOLS AND TECHNIQUES

- **Surveys and interviews**
- **Information theory and entropy**
- **Genetic, memetic, and evolutionary algorithms**
- **Modeling and simulation**
  - **Rumor propagation models (e.g., NSF program); epidemic-like models**
  - **Social media and networking**
  - **Rumor and gossip theory and psychological models (e.g., Naval Postgraduate School)**
  - **Rumor propagation dynamics on networks**
  - **Modeling theory of mind with decision-theoretic agents (e.g., PsychSim)**
  - **Agent-based simulation of geopolitical conflict**

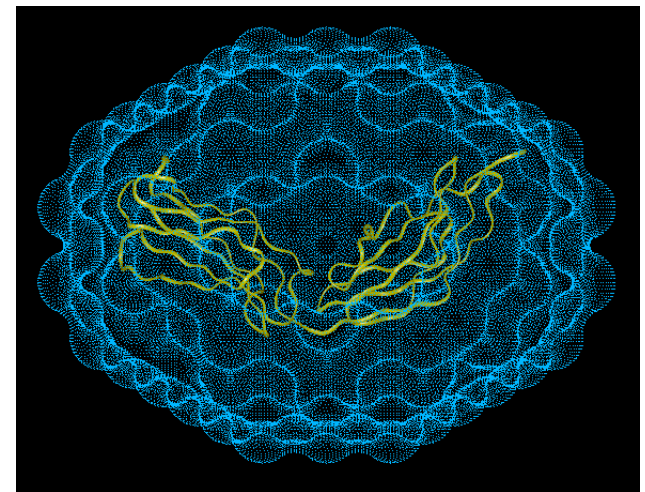
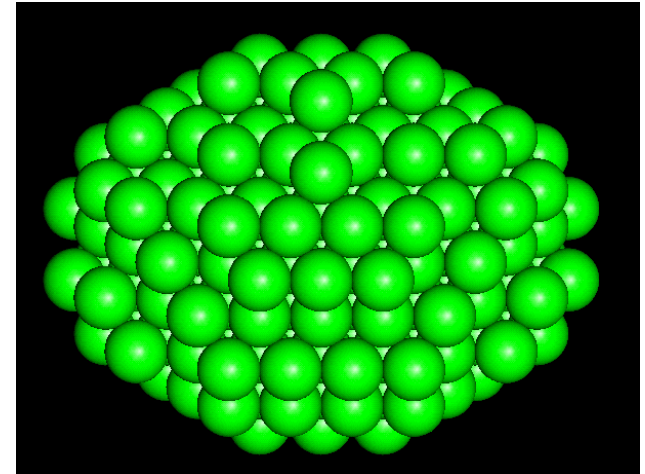

# TOOLS AND TECHNIQUES

- **Neuroeconomics tools**
  - **Neuroimaging**
    - Functional Magnetic Resonance Imaging (fMRI)
    - Positron Emission Tomography (PET)
  - Genetic profiling
  - Psychopharmacological manipulations
  - Psychophysiology (electromyography (EMG), event related potential (ERP), and electroencephalogram (EEG))
  - Behavioral measures
  - Psychological testing
  - Blood chemistry (and hormone) analysis
  - Single neuron recording
- **Example: FMRI scans have revealed:**
  - Political disparities in brain areas
  - Mirror neurons reflecting social cues and behavior of others and related to empathy and altruism

